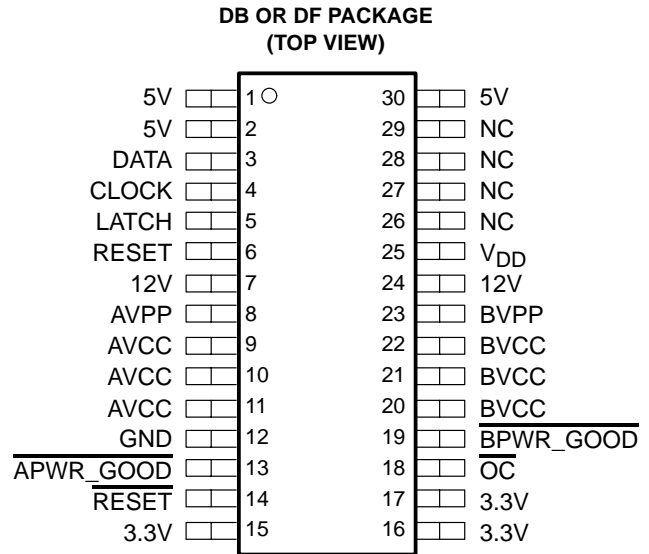


# TPS2202AI

## DUAL-SLOT PC CARD POWER-INTERFACE SWITCH WITH RESET FOR SERIAL PCMCIA CONTROLLER

SLVS123B – SEPTEMBER 1995 – REVISED JANUARY 2001

- Fully Integrated  $V_{CC}$  and  $V_{pp}$  Switching for Dual-Slot PC Card™ Interface
- P<sup>2</sup>C™ 3-Lead Serial Interface Compatible With CardBus™ Controllers
- Meets PC Card Standards
- RESET Allows System Initialization of PC Cards
- 12-V Supply Can Be Disabled Except During 12-V Flash Programming
- Short-Circuit and Thermal Protection
- Space-Saving 30-Pin SSOP (DB) Package
- Compatible With 3.3-V, 5-V and 12-V PC Cards
- Power Saving  $I_{DD} = 83 \mu\text{A Typ}$ ,  $I_Q = 1 \mu\text{A}$
- Low  $r_{DS(on)}$  (160-m $\Omega$   $V_{CC}$  Switch)
- Break-Before-Make Switching



NC – No internal connection

### description

The TPS2202AI PC Card power-interface switch provides an integrated power-management solution for two PC Cards. All of the discrete power MOSFETs, a logic section, current limiting, thermal protection, and power-good reporting for PC Card control are combined on a single integrated circuit (IC), using the Texas Instruments LinBiCMOS™ process. The circuit allows the distribution of 3.3-V, 5-V, and/or 12-V card power by means of the P<sup>2</sup>C (PCMCIA Peripheral-Control) Texas Instruments nonproprietary serial interface. The current-limiting feature eliminates the need for fuses, which reduces component count and improves reliability. Current-limit reporting can help the user isolate a system fault to a specific card.

The TPS2202AI incorporates a reset function, selectable by one of two inputs, to help alleviate system errors. The reset function enables PC Card initialization concurrent with host platform initialization, allowing a system reset. Reset is accomplished by grounding the  $V_{CC}$  and  $V_{pp}$  (flash-memory programming voltage) outputs, which discharges residual card voltage.

End equipment for the TPS2202AI includes notebook computers, desktop computers, personal digital assistants (PDAs), digital cameras, handterminals, and bar-code scanners.

#### AVAILABLE OPTIONS

T <sub>J</sub>	PACKAGED DEVICES	
	SSOP (DB)†	SSOP (DF)†
–40°C to 150°C	TPS2202AIDBR	TPS2202AIDFR

† The DB and DF packages are only available taped and reeled, indicated by the R suffix on the device type.



Please be aware that an important notice concerning availability, standard warranty, and use in critical applications of Texas Instruments semiconductor products and disclaimers thereto appears at the end of this data sheet.

LinBiCMOS and P<sup>2</sup>C are trademarks of Texas Instruments.  
PC Card and CardBus are trademarks of PCMCIA (Personal Computer Memory Card International Association).

PRODUCTION DATA information is current as of publication date. Products conform to specifications per the terms of Texas Instruments standard warranty. Production processing does not necessarily include testing of all parameters.



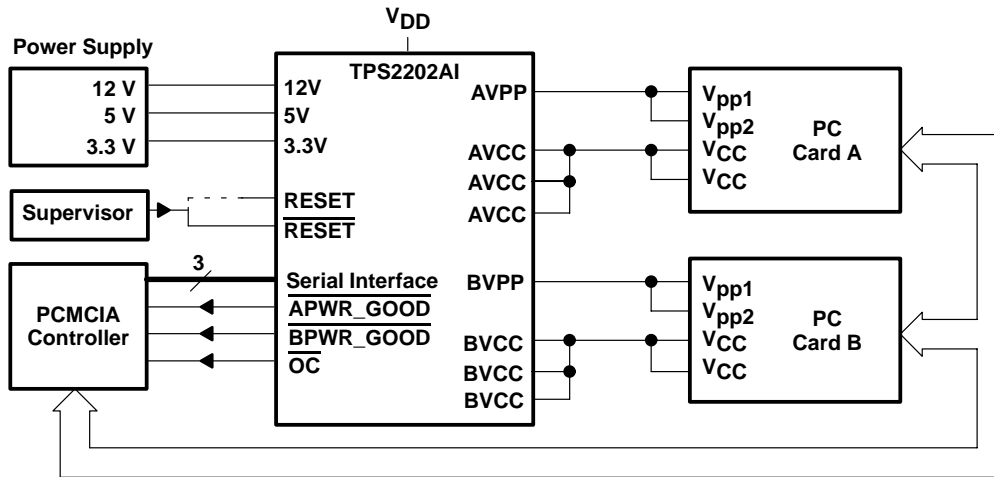
POST OFFICE BOX 655303 • DALLAS, TEXAS 75265

Copyright © 2001, Texas Instruments Incorporated

# TPS2202AI DUAL-SLOT PC CARD POWER-INTERFACE SWITCH WITH RESET FOR SERIAL PCMCIA CONTROLLER

SLVS123B – SEPTEMBER 1995 – REVISED JANUARY 2001

## typical PC card power-distribution application



## Terminal Functions

TERMINAL NAME	TERMINAL NO.	I/O	DESCRIPTION
3.3V	15, 16, 17	I	3.3-V $V_{CC}$ input for card power
5V	1, 2, 30	I	5-V $V_{CC}$ input for card power
12V	7, 24	I	12-V $V_{pp}$ input for card power
AVCC	9, 10, 11	O	Switched output that delivers 3.3 V, 5 V, low or high impedance to card
AVPP	8	O	Switched output that delivers 3.3 V, 5 V, 12 V, low or high impedance to card
APWR_GOOD	13	O	Logic-level power-ready output that stays low as long as AVPP is within limits
BVCC	20, 21, 22	O	Switched output that delivers 3.3 V, 5 V, low or high impedance
BVPP	23	O	Switched output that delivers 3.3 V, 5 V, 12 V, low or high impedance
BPWR_GOOD	19	O	Logic-level power-ready output that remains low as long as BVPP is within limits
CLOCK	4	I	Logic-level clock for serial data word
DATA	3	I	Logic-level serial data word
GND	12		Ground
LATCH	5	I	Logic-level latch for serial data word
NC	26, 27, 28, 29		No internal connection
$\overline{OC}$	18	O	Logic-level overcurrent reporting output that goes low when an overcurrent condition exists
RESET	6	I	Logic-level $\overline{RESET}$ input active high. Do not connect if terminal 14 is used.
$\overline{RESET}$	14	I	Logic-level $\overline{RESET}$ input active low. Do not connect if terminal 6 is used.
VDD	25	I	5-V power to chip

**TPS2202AI**  
**DUAL-SLOT PC CARD POWER-INTERFACE SWITCH**  
**WITH RESET FOR SERIAL PCMCIA CONTROLLER**

SLVS123B – SEPTEMBER 1995 – REVISED JANUARY 2001

**absolute maximum ratings over operating free-air temperature (unless otherwise noted)†**

Supply voltage range, $V_{DD}$ .....	-0.3 V to 7 V
Input voltage range for card power: $V_{I(5V)}$ .....	-0.3 V to 7 V
$V_{I(3.3V)}$ .....	-0.3 V to $V_{I(5V)}$
$V_{I(12V)}$ .....	-0.3 V to 14 V
Logic input voltage .....	-0.3 V to 7 V
Continuous total power dissipation .....	See Dissipation Rating Table
Output current (each card): $I_{O(xVCC)}$ .....	internally limited
$I_{O(xVPP)}$ .....	internally limited
Operating virtual junction temperature range, $T_J$ .....	-40°C to 150°C
Operating free-air temperature range, $T_A$ .....	-40°C to 85°C
Storage temperature range, $T_{stg}$ .....	-55°C to 150°C
Lead temperature 1,6 mm (1/16 inch) from case for 10 seconds .....	260°C

† Stresses beyond those listed under “absolute maximum ratings” may cause permanent damage to the device. These are stress ratings only, and functional operation of the device at these or any other conditions beyond those indicated under “recommended operating conditions” is not implied. Exposure to absolute-maximum-rated conditions for extended periods may affect device reliability.

**DISSIPATION RATING TABLE**

PACKAGE	$T_A \leq 25^\circ\text{C}$ POWER RATING	DERATING FACTOR‡ ABOVE $T_A = 25^\circ\text{C}$	$T_A = 70^\circ\text{C}$ POWER RATING	$T_A = 85^\circ\text{C}$ POWER RATING
DF	1158 mW	9.26 mW/°C	741 mW	602 mW
DB	1024 mW	8.2 mW/°C	655 mW	532 mW

‡ These devices are mounted on an FR4 board with no special thermal considerations.

**recommended operating conditions**

		MIN	MAX	UNIT
Supply voltage, $V_{DD}$		4.75	5.25	V
Input voltage range, $V_I$	$V_{I(5V)}$	0	5.25	V
	$V_{I(3.3V)}$	0	$V_{I(5V)}$ §	V
	$V_{I(12V)}$	0	13.5	V
Output current	$I_{O(xVCC)}$ at 25°C		1	A
	$I_{O(xVPP)}$ at 25°C		150	mA
Clock frequency		0	2.5	MHz
Operating virtual junction temperature, $T_J$		-40	125	°C

§  $V_{I(3.3V)}$  should not be taken above  $V_{I(5V)}$ .



**TPS2202AI**  
**DUAL-SLOT PC CARD POWER-INTERFACE SWITCH**  
**WITH RESET FOR SERIAL PCMCIA CONTROLLER**

SLVS123B – SEPTEMBER 1995 – REVISED JANUARY 2001

**electrical characteristics,  $T_A = 25^\circ\text{C}$ ,  $V_{DD} = 5\text{ V}$  (unless otherwise noted)**

**dc characteristics**

PARAMETER		TEST CONDITIONS	MIN	TYP	MAX	UNIT
Switch resistances†	5 V to xVCC				160	mΩ
	3.3 V to xVCC				225	
	5 V to xVPP				6	Ω
	3.3 V to xVPP				6	
	12 V to xVPP				1	
$V_{O(xVPP)}$	Clamp low voltage	$I_{pp}$ at 10 mA			0.8	V
$V_{O(xVCC)}$	Clamp low voltage	$I_{CC}$ at 10 mA			0.8	V
$I_{lkg}$	Leakage current	$I_{pp}$ High-impedance state	$T_A = 25^\circ\text{C}$	1	10	μA
			$T_A = 85^\circ\text{C}$		50	
	$I_{CC}$ High-impedance state	$T_A = 25^\circ\text{C}$	1	10		
		$T_A = 85^\circ\text{C}$		50		
$I_I$	Input current	$I_{DD}$ Supply current	$V_{O(AVCC)} = V_{O(BVCC)} = 5\text{ V}$ , $V_{O(AVPP)} = V_{O(BVPP)} = 12\text{ V}$	83	150	μA
		$I_{DD}$ Supply current in shutdown	$V_{O(BVCC)} = V_{O(AVCC)} = V_{O(AVPP)} = V_{O(BVPP)} = \text{Hi-Z}$		1	μA
	Power-ready threshold, $\overline{\text{PWR\_GOOD}}$		10.72	11.05	11.4	V
	Power-ready hysteresis, $\overline{\text{PWR\_GOOD}}$	12-V mode		50		mV
Short-circuit output-current limit	$I_{O(xVCC)}$	$T_J = 85^\circ\text{C}$ , Output powered up into a short to GND	0.75	1.3	1.9	A
	$I_{O(xVPP)}$		120	200	400	mA

† Pulse-testing techniques are used to maintain junction temperature close to ambient temperature; thermal effects must be taken into account separately.

**logic section**

PARAMETER	TEST CONDITIONS	MIN	MAX	UNIT
Logic input current			1	μA
Logic input high level		2		V
Logic input low level			0.8	V
Logic output high level	$I_O = 1\text{ mA}$	$V_{DD} - 0.4$		V
Logic output low level			0.4	V
Logic input minimum pulse width		1		μs



**TPS2202AI**  
**DUAL-SLOT PC CARD POWER-INTERFACE SWITCH**  
**WITH RESET FOR SERIAL PCMCIA CONTROLLER**

SLVS123B – SEPTEMBER 1995 – REVISED JANUARY 2001

**switching characteristics†**

PARAMETER		TEST CONDITIONS		MIN	TYP	MAX	UNIT
t <sub>r</sub>	Output rise times	V <sub>O(xVCC)</sub>			1.2		ms
		V <sub>O(xVPP)</sub>			5		
t <sub>f</sub>	Output fall times	V <sub>O(xVCC)</sub>			10		
		V <sub>O(xVPP)</sub>			14		
t <sub>pd</sub>	Propagation delay (see Figure 1‡)	LATCH↑ to V <sub>O(xVPP)</sub>	t <sub>on</sub>		5.8		ms
			t <sub>off</sub>		18		ms
		LATCH↑ to xVCC (3 V)	t <sub>on</sub>		5.8		ms
			t <sub>off</sub>		28		ms
		LATCH↑ to xVCC (5 V)	t <sub>on</sub>		4		ms
			t <sub>off</sub>		30		ms

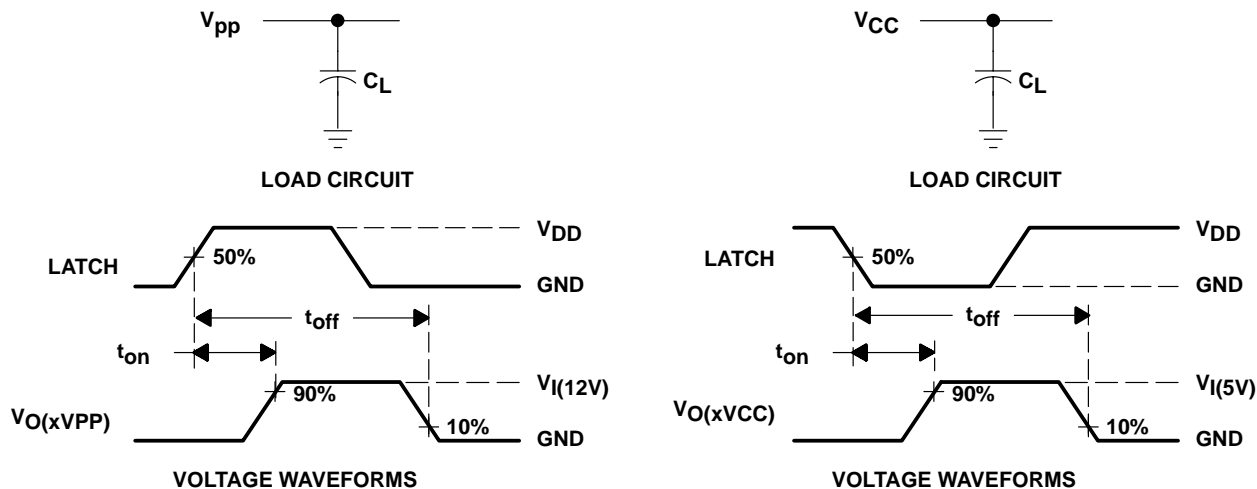
† Refer to Parameter Measurement Information

‡ Propagation delays are with C<sub>L</sub> = 100 μF.

**TPS2202AI**  
**DUAL-SLOT PC CARD POWER-INTERFACE SWITCH**  
**WITH RESET FOR SERIAL PCMCIA CONTROLLER**

SLVS123B – SEPTEMBER 1995 – REVISED JANUARY 2001

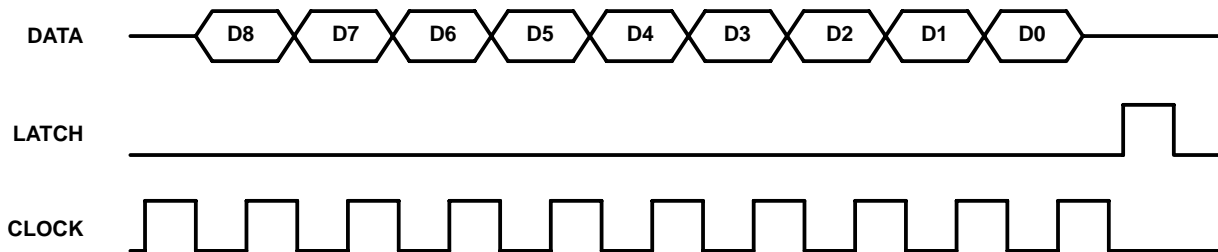
**PARAMETER MEASUREMENT INFORMATION**



**Figure 1. Test Circuits and Voltage Waveforms**

**Table of Timing Diagrams**

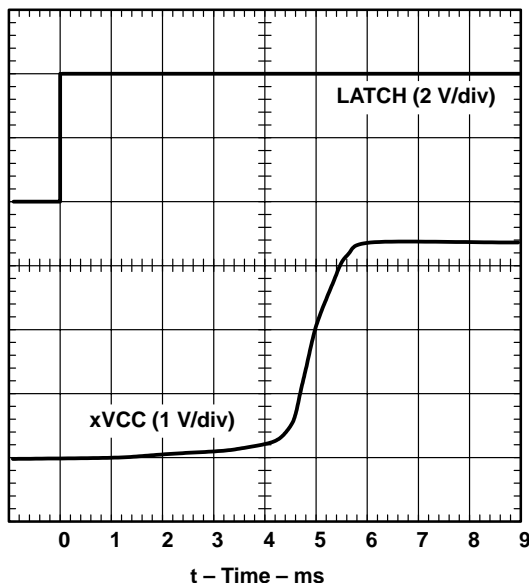
	FIGURE
Serial-Interface Timing	2
xVCC Propagation Delay and Rise Time With 1- $\mu$ F Load, 3.3-V Switch	3
xVCC Propagation Delay and Fall Time With 1- $\mu$ F Load, 3.3-V Switch	4
xVCC Propagation Delay and Rise Time With 100- $\mu$ F Load, 3.3-V Switch	5
xVCC Propagation Delay and Fall Time With 100- $\mu$ F Load, 3.3-V Switch	6
xVCC Propagation Delay and Rise Time With 1- $\mu$ F Load, 5-V Switch	7
xVCC Propagation Delay and Fall Time With 1- $\mu$ F Load, 5-V Switch	8
xVCC Propagation Delay and Rise Time With 100- $\mu$ F Load, 5-V Switch	9
xVCC Propagation Delay and Fall Time With 100- $\mu$ F Load, 5-V Switch	10
xVPP Propagation Delay and Rise Time With 1- $\mu$ F Load, 12-V Switch	11
xVPP Propagation Delay and Fall Time With 1- $\mu$ F Load, 12-V Switch	12
xVPP Propagation Delay and Rise Time With 100- $\mu$ F Load, 12-V Switch	13
xVPP Propagation Delay and Fall Time With 100- $\mu$ F Load, 12-V Switch	14



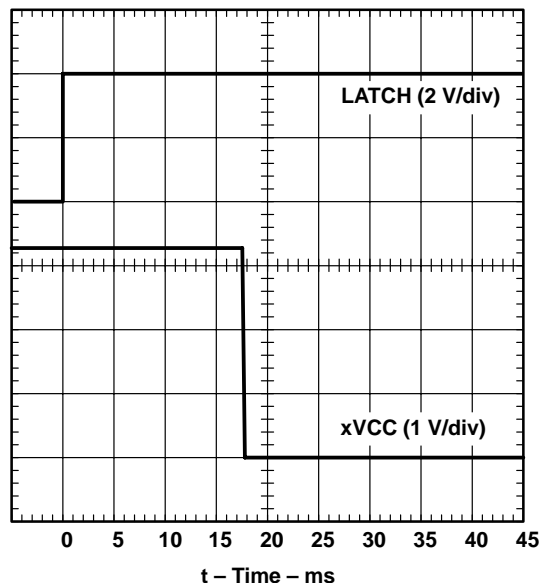
NOTE A: Data is clocked in on the positive leading edge of the clock. The latch should occur before next positive leading edge of the clock. For definition of D0 to D8, see the control logic table.

**Figure 2. Serial-Interface Timing**

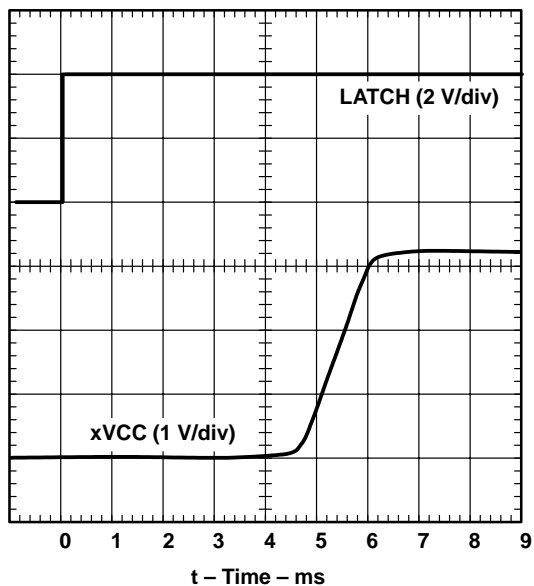
**PARAMETER MEASUREMENT INFORMATION**



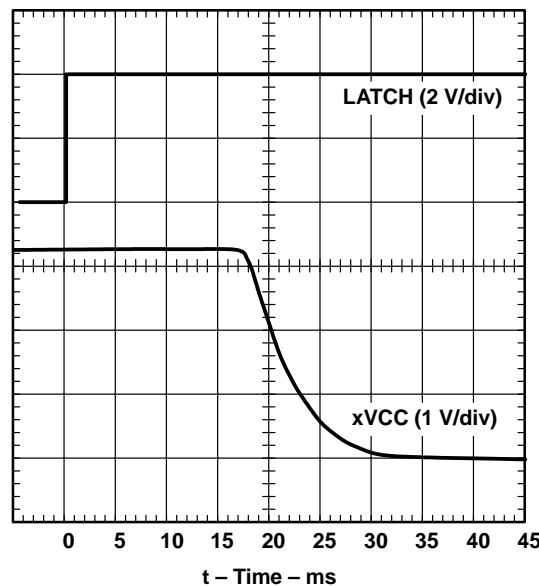
**Figure 3. xVCC Propagation Delay and Rise Time With 1- $\mu$ F Load, 3.3-V Switch**



**Figure 4. xVCC Propagation Delay and Fall Time With 1- $\mu$ F Load, 3.3-V Switch**

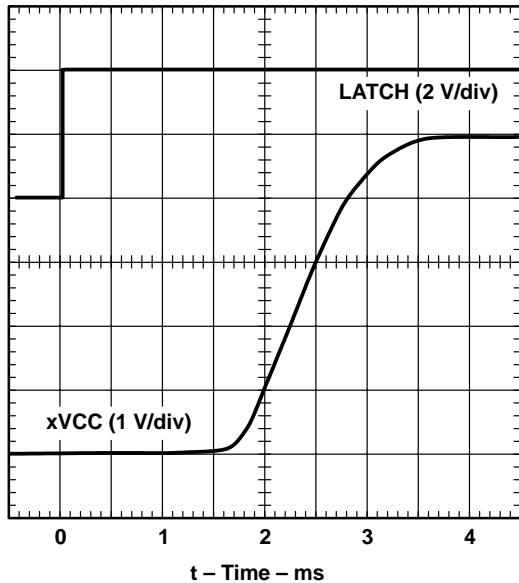


**Figure 5. xVCC Propagation Delay and Rise Time With 100- $\mu$ F Load, 3.3-V Switch**

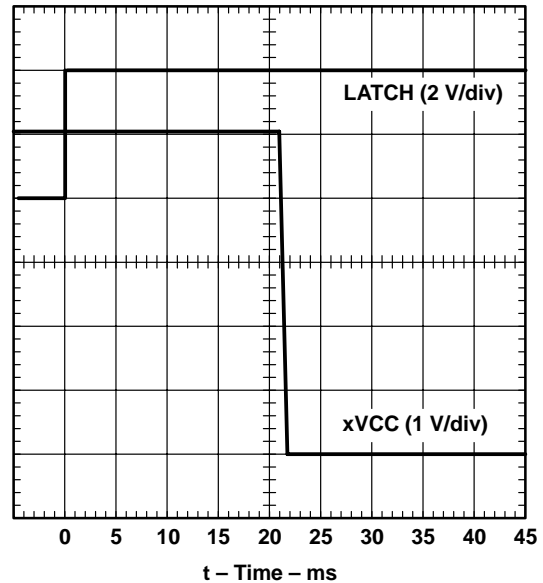


**Figure 6. xVCC Propagation Delay and Fall Time With 100- $\mu$ F Load, 3.3-V Switch**

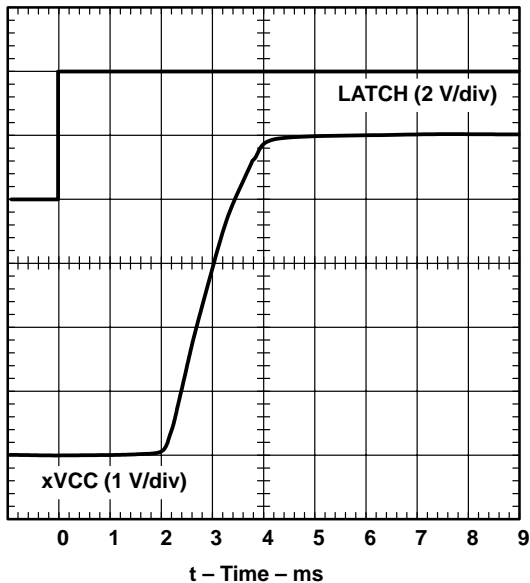
**PARAMETER MEASUREMENT INFORMATION**



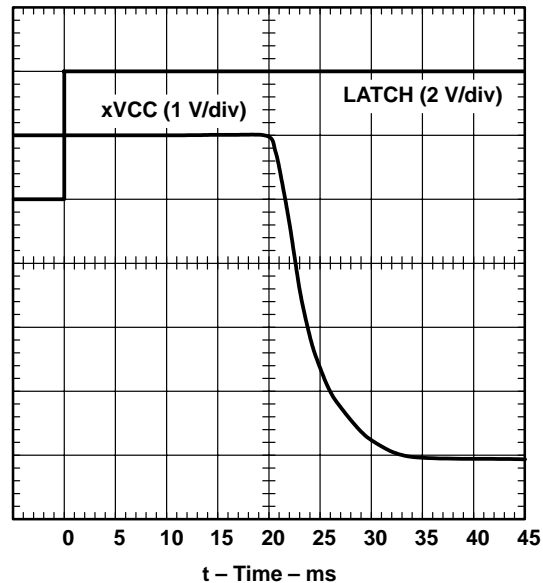
**Figure 7. xVCC Propagation Delay and Rise Time With 1- $\mu$ F Load, 5-V Switch**



**Figure 8. xVCC Propagation Delay and Fall Time With 1- $\mu$ F Load, 5-V Switch**



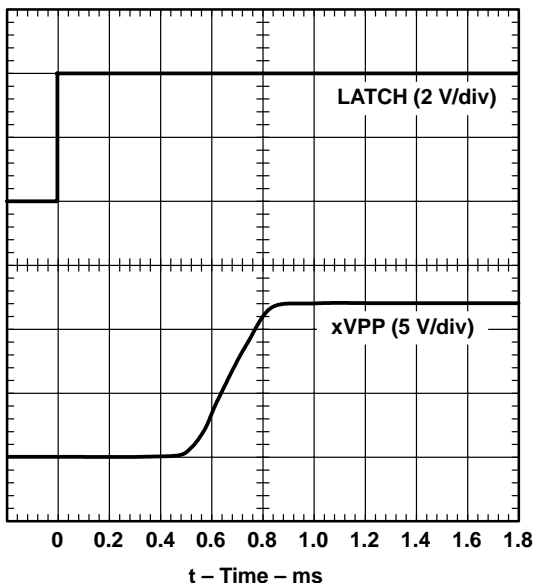
**Figure 9. xVCC Propagation Delay and Rise Time With 100- $\mu$ F Load, 5-V Switch**



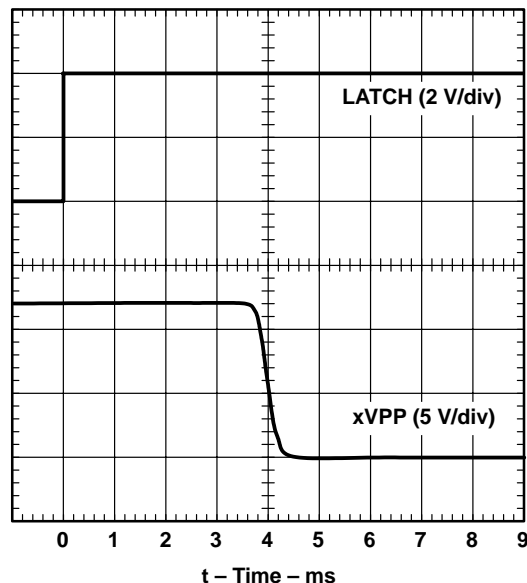
**Figure 10. xVCC Propagation Delay and Fall Time With 100- $\mu$ F Load, 5-V Switch**



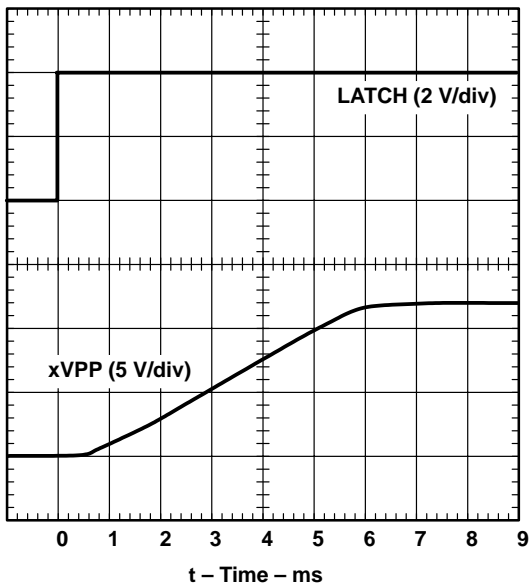
**PARAMETER MEASUREMENT INFORMATION**



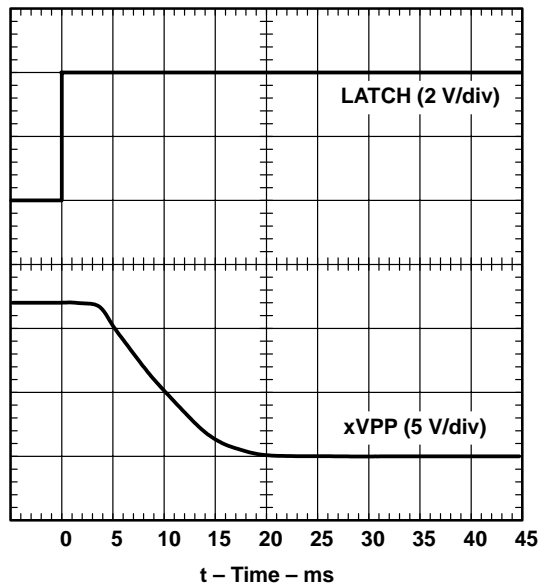
**Figure 11. xVPP Propagation Delay and Rise Time With 1- $\mu$ F Load, 12-V Switch**



**Figure 12. xVPP Propagation Delay and Fall Time With 1- $\mu$ F Load, 12-V Switch**



**Figure 13. xVPP Propagation Delay and Rise Time With 100- $\mu$ F Load, 12-V Switch**



**Figure 14. xVPP Propagation Delay and Fall Time With 100- $\mu$ F Load, 12-V Switch**

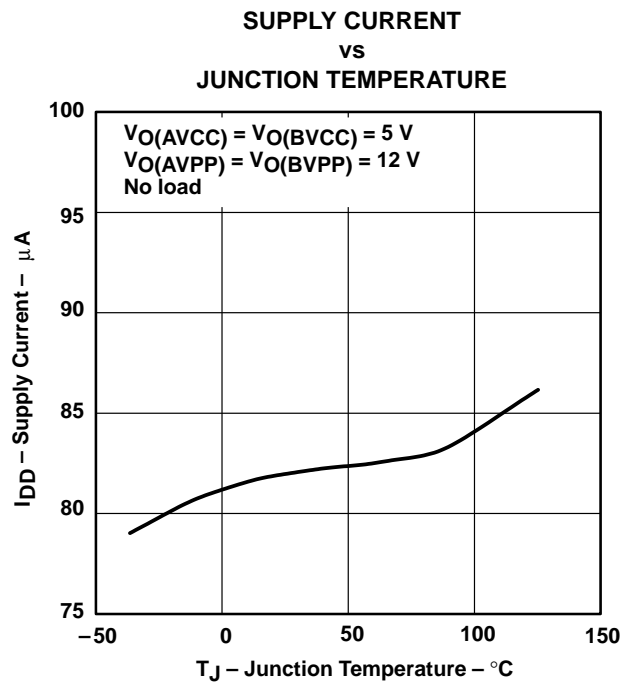
**TPS2202AI**  
**DUAL-SLOT PC CARD POWER-INTERFACE SWITCH**  
**WITH RESET FOR SERIAL PCMCIA CONTROLLER**

SLVS123B – SEPTEMBER 1995 – REVISED JANUARY 2001

**TYPICAL CHARACTERISTICS†**

**Table of Graphs**

			<b>FIGURE</b>
$I_{DD}$	Supply current	vs Junction temperature	15
$r_{DS(on)}$	Static drain-source on-state resistance, 3-V switch	vs Junction temperature	16
$r_{DS(on)}$	Static drain-source on-state resistance, 5-V switch	vs Junction temperature	17
$r_{DS(on)}$	Static drain-source on-state resistance, 12-V switch	vs Junction temperature	18
$V_O(xVCC)$	Output voltage, 5-V switch	vs Output current	19
$V_O(xVCC)$	Output voltage, 3.3-V switch	vs Output current	20
$xVPP$	Output voltage, $V_{pp}$ switch	vs Output current	21
$I_{SC}(xVCC)$	Short-circuit current, 5-V switch	vs Junction temperature	22
$I_{SC}(xVPP)$	Short-circuit current, 12-V switch	vs Junction temperature	23



† t = pulse tested



**TYPICAL CHARACTERISTICS†**

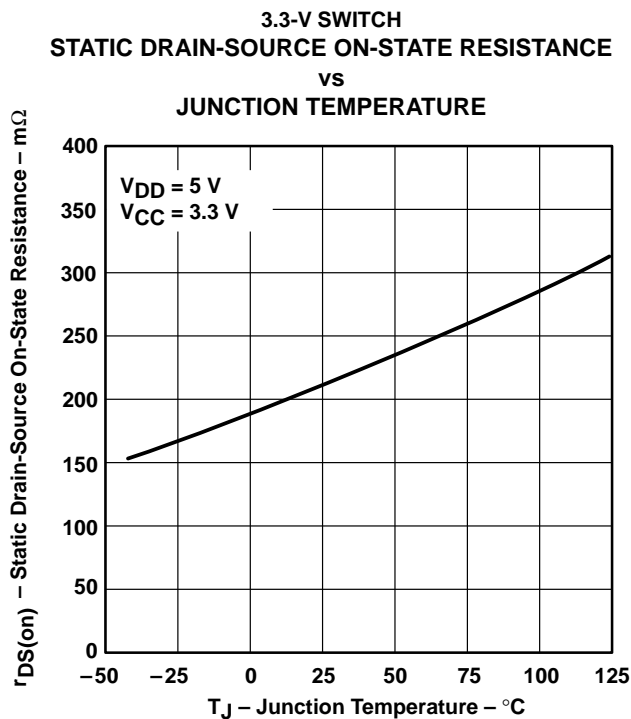


Figure 16

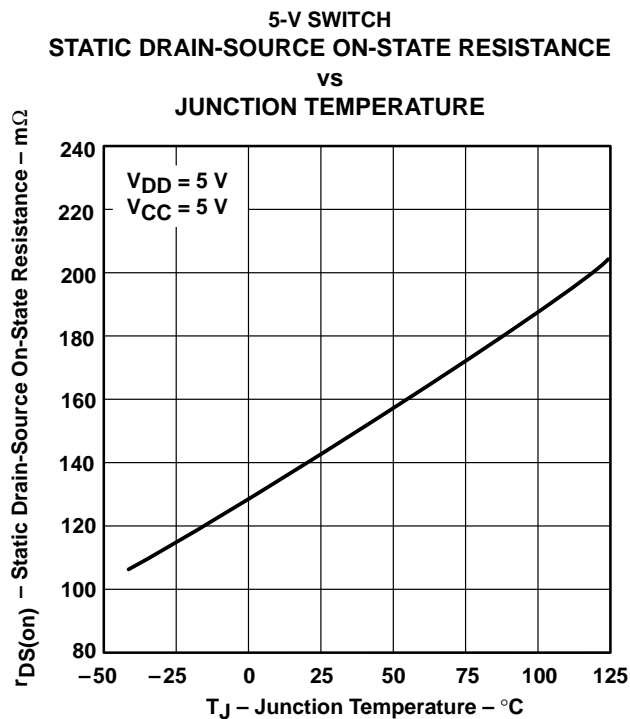


Figure 17

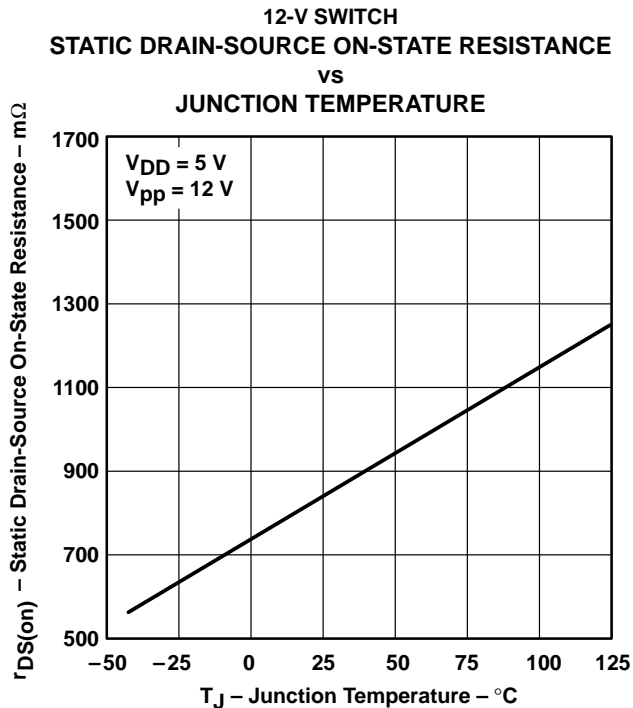


Figure 18

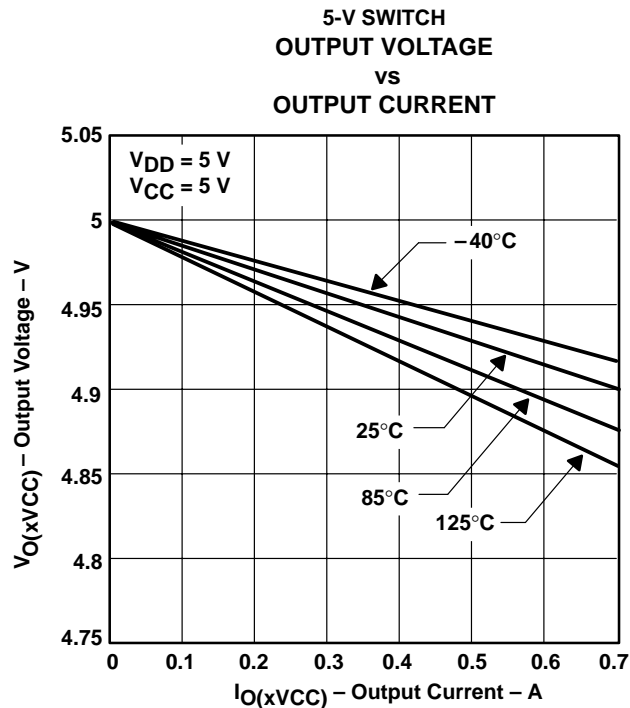


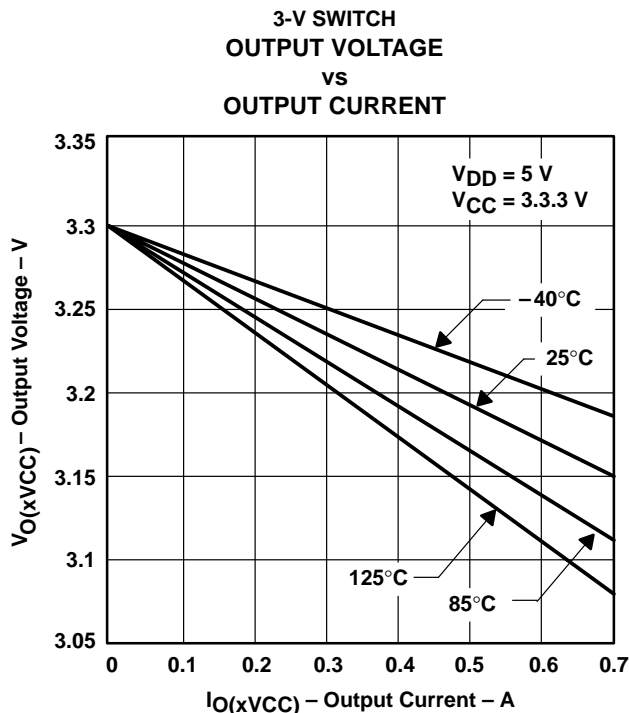
Figure 19

† t = pulse tested

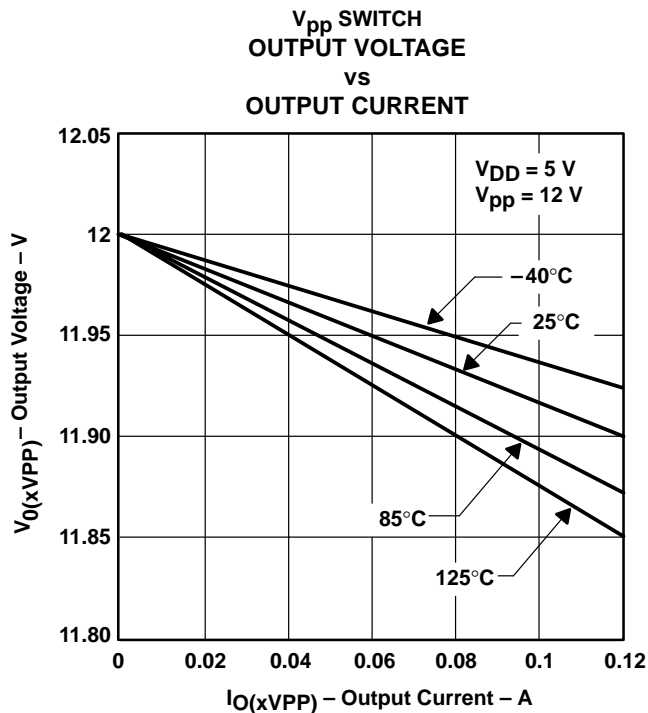
**TPS2202AI**  
**DUAL-SLOT PC CARD POWER-INTERFACE SWITCH**  
**WITH RESET FOR SERIAL PCMCIA CONTROLLER**

SLVS123B – SEPTEMBER 1995 – REVISED JANUARY 2001

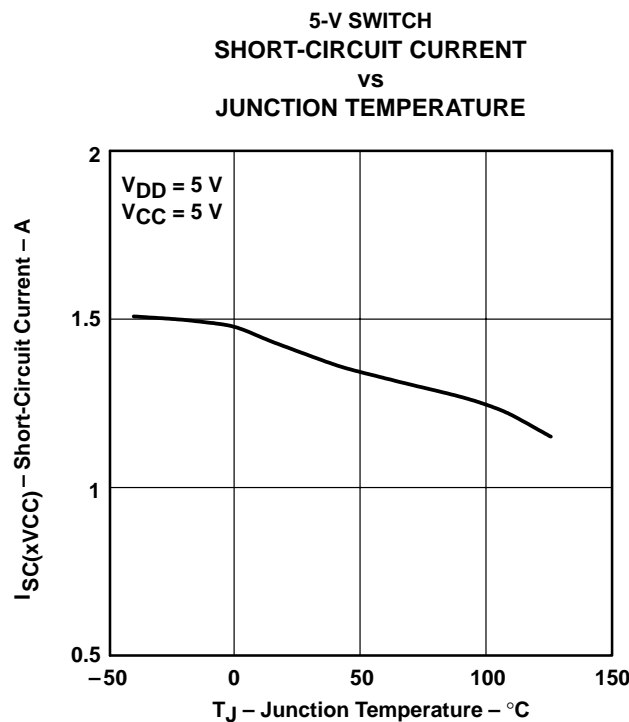
**TYPICAL CHARACTERISTICS†**



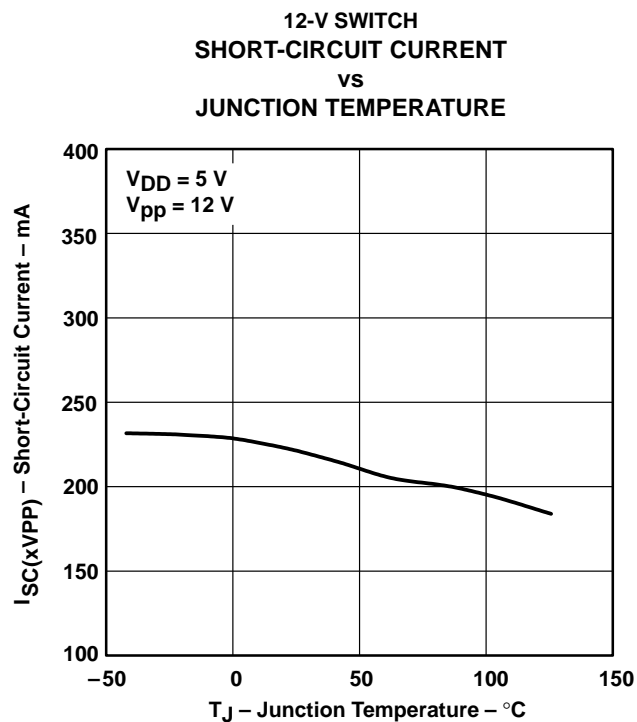
**Figure 20**



**Figure 21**



**Figure 22**



**Figure 23**

† t = pulse tested



## APPLICATION INFORMATION

### overview

PC Cards were initially introduced as a means to add EEPROM (flash memory) to portable computers with limited on-board memory. The idea of add-in cards quickly took hold; modems, wireless LANs, GPS systems, multimedia, and hard-disk versions were soon available. As the number of PC Card applications grew, the engineering community quickly recognized the need for a standard to ensure compatibility across platforms. To this end, the PCMCIA (Personal Computer Memory Card International Association) was established, comprised of members from leading computer, software, PC card, and semiconductor manufacturers. One key goal was to realize the *plug-and-play* concept. Cards and hosts from different vendors should be compatible and able to communicate with one another transparently.

### PC Card power specification

System compatibility also means power compatibility. The most current set of specifications (PC Card Standard) set forth by the PCMCIA committee states that power is to be transferred between the host and the card through eight of the PC Card connector's 68 terminals. This power interface consists of two  $V_{CC}$ , two  $V_{pp}$ , and four ground terminals. Multiple  $V_{CC}$  and ground terminals minimize connector-terminal and line resistance. The two  $V_{pp}$  terminals were originally specified as separate signals but are commonly tied together in the host to form a single node to minimize voltage losses. Card primary power is supplied through the  $V_{CC}$  terminals; flash-memory programming and erase voltage is supplied through the  $V_{pp}$  terminals. As each terminal is rated to 0.5 A,  $V_{CC}$  and  $V_{pp}$  can theoretically supply up to 1 A, assuming equal terminal resistance and no terminal failure. A conservative design would limit current to 500 mA. Some applications, however, require higher  $V_{CC}$  currents. Disk drives, for example, may need as much as 750-mA peak current to create the initial torque necessary to spin up the platter.  $V_{pp}$  currents, on the other hand, are defined by flash-memory programming requirements, typically under 120 mA.

### future power trends

The 1-A physical-terminal current alluded to in the PC Card specification has caused some host-system engineers to believe they are required to deliver 1 A within the voltage tolerance of the card. Future applications, such as RF cards, could use the extra power for their radio transmitters. The 5 W required for these cards require very robust power supplies and special cooling considerations. The limited number of host sockets that are able to support cards makes the market for these high-powered PC Cards uncertain. The vast majority of the cards require less than 600 mA continuous current, and the trend is towards even lower powered PC Cards that assure compatibility with a greater number of host systems. Recognizing the need for power derating, an ad hoc committee of the PCMCIA is currently working to limit the amount of steady-state dc current to the PC Card to something less than the currently implied 1 A. When a system is designed to support 1 A, the switch  $r_{DS(on)}$ , power-supply requirements, and PC Card cooling need to be carefully considered.

### designing around 1-A delivery

Delivering 1 A means minimizing voltage and power losses across the PC Card power interface, which requires that designers trade off switch resistance and the cost associated with large-die (low  $r_{DS(on)}$ ) MOSFET transistors. The PC Card standard requires that 5 V  $\pm 5\%$  or 3.3 V  $\pm 0.3$  V be supplied to the card. The approximate 10% tolerance for the 3.3-V supply makes the 3.3-V  $r_{DS(on)}$  less critical than the 5-V switch. A conservative approach is to allow 2% for voltage-regulator tolerance and 1% for etch- and pin-resistance drops, which leaves 2% (100 mV) for voltage drop at the 5-V switch and at least 6% (198 mV) for the 3.3-V switch.

# TPS2202AI

## DUAL-SLOT PC CARD POWER-INTERFACE SWITCH WITH RESET FOR SERIAL PCMCIA CONTROLLER

SLVS123B – SEPTEMBER 1995 – REVISED JANUARY 2001

---

### APPLICATION INFORMATION

#### designing around 1-A delivery (continued)

Calculating the  $r_{DS(on)}$  necessary to support a 100 mV or 198 mV switch loss, using  $R = E/I$  and setting  $I = 1$  A, the 5-V and 3.3-V switches would need to be 100 m $\Omega$  and 198 m $\Omega$  respectively. One solution would be to pay for a more expensive switch with lower  $r_{DS(on)}$ . A second, less expensive approach is to increase the headroom of the power supply—for example, to increase the 5 V supply 1.5% or to  $5.075 \pm 2\%$ . Working through the numbers once more, the 2% for the regulator plus 1 % for etch and terminal losses leaves 97% or 4.923 V. The allowable voltage loss across the power distribution switch is now 4.923 V minus 4.750 V or 173 mV. Therefore, a switch with 173 m $\Omega$  or less could deliver 1 A or greater. Setting the power supply high is a common practice for delivering voltages to allow for system switch connector and etch losses. This practice has a minimal effect on overall battery life. In the example above, setting the power supply 1.5% high would only decrease a 3-hour battery life by approximately 2.7 minutes, trivial when compared with the decrease in battery life when running a 5-W PC Card.

#### heat dissipation

A greater concern in delivering 1 A or 5 W is the ability of the host to dissipate the heat generated by the PC Card. For desktop computers the solution is simpler: locate the PC Card cage such that it receives convection cooling from the forced air of the fan. Notebooks and other handheld equipment will not be able to rely on convection, but on conduction of heat away from the PC Card through the rails into the card cage. This is difficult because PC Card/card cage heat transfer is very poor. A typical design scenario would require the PC Card to be held at 60°C maximum with the host platform operating as high as 50°C. Preliminary testing reveals that a PC Card can have a 20°C rise, exceeding the 10°C differential in the example, when dissipating less than 2 W of continuous power. Sixty degrees centigrade was chosen because it is the maximum operating temperature allowable by PC Card specification. Power handling requirements and temperature rises are topics of concern and are currently being addressed by the PCMCIA committee.

#### overcurrent and overtemperature protection

PC Cards are inherently subject to damage that can result from mishandling. Host systems require protection against short-circuited cards that could lead to power supply or PCB-trace damage. Even systems sufficiently robust to withstand a short circuit would still undergo rapid battery discharge into the damaged PC Card, resulting in the rather sudden and unacceptable loss of system power. Most hosts include fuses for protection. The reliability of fused systems is poor though, as blown fuses require troubleshooting and repair, usually by the manufacturer.

The TPS2202AI takes a two-pronged approach to overcurrent protection. First, instead of fuses, sense FETs monitor each of the power outputs. Excessive current generates an error signal that linearly limits the output current, preventing host damage or failure. Sense FETs, unlike sense resistors or polyfuses, have an added advantage in that they do not add to the series resistance of the switch and thus produce no additional voltage losses. Second, when an overcurrent condition is detected, the TPS2202AI asserts a signal at  $\overline{OC}$  that can be monitored by the microprocessor to initiate diagnostics and/or send the user a warning message. In the event that an overcurrent condition persists, causing the IC to exceed its maximum junction temperature, thermal-protection circuitry activates, shutting down all power outputs until the device cools to within a safe operating region.



---

## APPLICATION INFORMATION

### 12-V supply not required

Most PC Card switches use the externally supplied 12-V  $V_{pp}$  power for switch-gate drive and other chip functions, which requires that power be present at all times. The TPS2202AI offers considerable power savings by using an internal charge pump to generate the required higher voltages from the 5-V  $V_{DD}$  supply; therefore, the external 12-V supply can be disabled except when needed for flash-memory functions, thereby extending battery lifetime. Do not ground the 12-V inputs when 12-V supply is not in use. Additional power savings are realized by the TPS2202AI during a software shutdown in which quiescent current drops to a maximum of 1  $\mu$ A.

### voltage transitioning requirement

PC Cards, like portables, are migrating from 5 V to 3.3 V to minimize power consumption, optimize board space, and increase logic speeds. The TPS2202AI is designed to meet all combinations of power delivery as currently defined in the PCMCIA standard. The latest protocol accommodates mixed 3.3-V/5-V systems by first powering the card with 5 V, then polling it to determine its 3.3-V compatibility. The PCMCIA specification requires that the capacitors on 3.3-V-compatible cards be discharged to below 0.8 V before applying 3.3-V power. This ensures that sensitive 3.3-V circuitry is not subjected to any residual 5-V charge and functions as a power reset. The TPS2202AI offers a selectable  $V_{CC}$  and  $V_{pp}$  ground state, in accordance with PCMCIA 3.3-V/5-V switching specifications, to fully discharge the card capacitors while switching between  $V_{CC}$  voltages.

### output ground switches

Several PCMCIA power-distribution switches on the market do not have an active-grounding FET switch. These devices do not meet the PC Card specification requiring a discharge of  $V_{CC}$  within 100 ms. PC Card resistance can not be relied on to provide a discharge path for voltages stored on PC Card capacitance because of possible high-impedance isolation by power-management schemes. A method commonly shown to alleviate this problem is to add to the switch output an external 100-k $\Omega$  resistor in parallel with the PC Card. Considering that this is the only discharge path to ground, a timing analysis will reveal that the RC time constant delays the required discharge time to more than 2 seconds. The only way to ensure timing compatibility with PC Card standards is to use a power-distribution switch that has an internal ground switch, like that of the TPS22xx family, or add an external ground FET to each of the output lines with the control logic necessary to select it.

In summary, the TPS2202AI is a complete single-chip dual-slot PC Card power interface. It meets all currently defined PCMCIA specifications for power delivery in 5-V, 3.3-V, and mixed systems, and offers a serial controller interface. The TPS2202AI offers functionality, power savings, overcurrent and thermal protection, and fault reporting in one 30-pin SSOP surface-mount package for maximum value added to new portable designs.

### power-supply considerations

The TPS2202AI has multiple pins for each of its 3.3-V, 5-V, and 12-V power inputs and for the switched  $V_{CC}$  outputs. Any individual pin can conduct the rated input or output current. Unless all pins are connected in parallel, the series resistance is significantly higher than that specified, resulting in increased voltage drops and lost power. Both 12-V inputs must be connected for proper  $V_{pp}$  switching; it is recommended that all input and output power pins be paralleled for optimum operation. The  $V_{DD}$  input lead must be connected to the 5-V input leads.

Although the TPS2202AI is fairly immune to power input fluctuations and noise, it is generally considered good design practice to bypass power supplies typically with a 1- $\mu$ F electrolytic or tantalum capacitor paralleled by a 0.047- $\mu$ F to 0.1- $\mu$ F ceramic capacitor. It is strongly recommended that the switched  $V_{CC}$  and  $V_{pp}$  outputs be bypassed with a 0.1- $\mu$ F or larger capacitor; doing so improves the immunity of the TPS2202AI to electrostatic discharge (ESD). Care should be taken to minimize the inductance of PCB traces between the TPS2202AI and the load. High switching currents can produce large negative-voltage transients, which forward biases substrate diodes, resulting in unpredictable performance.

# TPS2202AI

## DUAL-SLOT PC CARD POWER-INTERFACE SWITCH WITH RESET FOR SERIAL PCMCIA CONTROLLER

SLVS123B – SEPTEMBER 1995 – REVISED JANUARY 2001

---

### APPLICATION INFORMATION

#### power-supply considerations (continued)

The TPS2202AI, unlike other PC Card power-interface switches, does not use the 12-V power supply for switching or other chip functions. Instead, an internal charge pump generates the necessary voltage from  $V_{DD}$ , allowing the 12-V input supply to be shut down except when the  $V_{pp}$  programming or erase voltage is needed. Careful system design using this feature reduces power consumption and extends battery lifetime.

The 3.3-V power input should not be taken higher than the 5-V input. Though doing so is nondestructive, this results in high current flow into the device and could result in abnormal operation. In any case, this occurrence indicates a malfunction of one input voltage or both, which should be investigated.

Similarly, no pin should be taken below  $-0.3$  V; forward biasing the parasitic-substrate diode results in substrate currents and unpredictable performance.

#### RESET or $\overline{\text{RESET}}$ inputs

To ensure that cards are in a known state after power brownouts or system initialization, the PC Cards should be reset at the same time as the host by applying a low impedance to the  $V_{CC}$  and  $V_{pp}$  terminals. A low-impedance output state allows discharging of residual voltage remaining on PC Card filter capacitance, permitting the system (host and PC Cards) to be powered up concurrently. The RESET or  $\overline{\text{RESET}}$  input will close internal switches S1, S4, S7, and S10 with all other switches left open (see TPS2202AI control-logic table). The TPS2202AI remains in the low-impedance output state until the signal is deasserted and further data is clocked in and latched. RESET or  $\overline{\text{RESET}}$  is provided for direct compatibility with systems that use either an active-low or active-high reset voltage supervisor. The unused pin is internally pulled up or down and should be left unconnected.

#### overcurrent and thermal protection

The TPS2202AI uses sense FETs to check for overcurrent conditions in each of the  $V_{CC}$  and  $V_{pp}$  outputs. Unlike sense resistors or polyfuses, these FETs do not add to the series resistance of the switch; therefore, voltage and power losses are reduced. Overcurrent sensing is applied to each output separately. When an overcurrent condition is detected, only the power output affected is limited; all other power outputs continue to function normally. The  $\overline{\text{OC}}$  indicator, normally a logic high, is a logic low when any overcurrent condition is detected, providing for initiation of system diagnostics and/or sending a warning message to the user.

During power up, the TPS2202AI controls the rise time of the  $V_{CC}$  and  $V_{pp}$  outputs and limits the current into a faulty card or connector. If a short circuit is applied after power is established (e.g., hot insertion of a bad card), current is initially limited only by the impedance between the short and the power supply. In extreme cases, as much as 10 A to 15 A may flow into the short before the current limiting of the TPS2202AI engages. If the  $V_{CC}$  or  $V_{pp}$  outputs are driven below ground, the TPS2202AI may latch nondestructively in an off state. Cycling power will reestablish normal operation.

Overcurrent limiting for the  $V_{CC}$  outputs is designed to activate, if powered up, into a short in the range of 0.75 A to 1.9 A, typically at about 1.3 A. The  $V_{pp}$  outputs limit from 120 mA to 400 mA, typically around 200 mA. The protection circuitry acts by linearly limiting the current passing through the switch rather than initiating a full shutdown of the supply. Shutdown occurs only during thermal limiting.

Thermal limiting prevents destruction of the IC from overheating if the package power-dissipation ratings are exceeded. Thermal limiting disables all power outputs (both A and B slots) until the device has cooled.



POST OFFICE BOX 655303 • DALLAS, TEXAS 75265



---

## APPLICATION INFORMATION

### calculating junction temperature

The switch resistance,  $r_{DS(on)}$ , is dependent on the junction temperature,  $T_J$ , of the die. The junction temperature is dependent on both  $r_{DS(on)}$  and the current through the switch. To calculate  $T_J$ , first find  $r_{DS(on)}$  from Figures 16, 17, and 18 using an initial temperature estimate about 50°C above ambient. Then calculate the power dissipation for each switch, using the formula:

$$P_D = r_{DS(on)} \times I^2$$

Next, sum the power dissipation and calculate the junction temperature:

$$T_J = \left( \sum P_D \times R_{\theta JA} \right) + T_A, \quad R_{\theta JA} = 108^\circ\text{C/W}$$

Compare the calculated junction temperature with the initial temperature estimate. If the temperatures are not within a few degrees of each other, recalculate using the calculated temperature as the initial estimate.

### logic input and outputs

The serial interface consists of DATA, CLOCK, and LATCH leads. The data is clocked in on the positive leading edge of the clock (see Figure 2). The 9-bit (D0 through D8) serial data word is loaded during the positive edge of the latch signal. The latch signal should occur before the next positive leading edge of the clock.

The shutdown bit of the data word places all  $V_{CC}$  and  $V_{pp}$  outputs in a high-impedance state and reduces chip quiescent current to 1  $\mu\text{A}$  to conserve battery power.

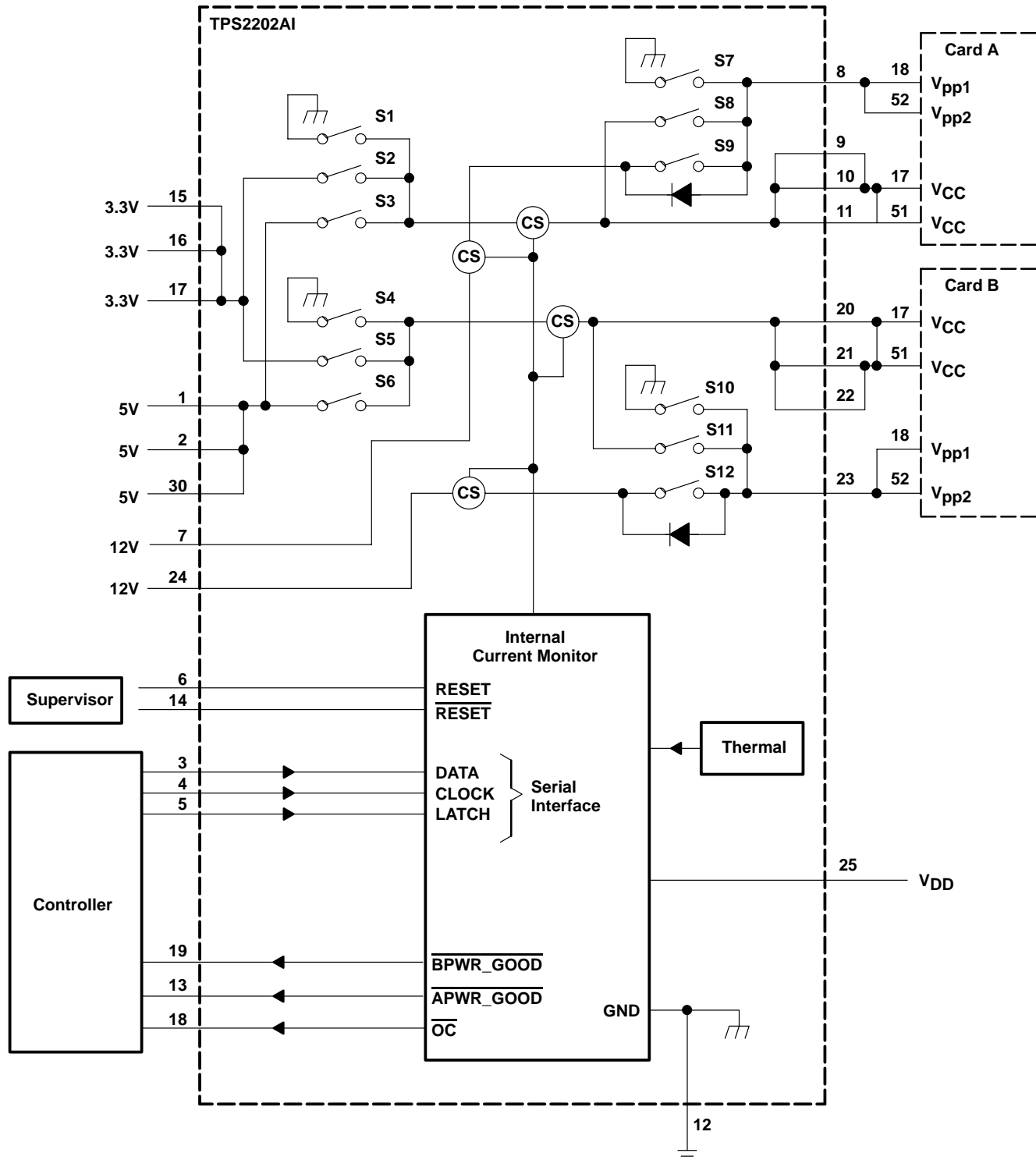
The TPS2202AI serial interface is designed to be compatible with serial-interface PCMCIA controllers and current PCMCIA and Japan Electronic Industry Development Association (JEIDA) standards.

An overcurrent output ( $\overline{OC}$ ) is provided to indicate an overcurrent condition in any of the  $V_{CC}$  or  $V_{pp}$  outputs as previously discussed.

**TPS2202AI**  
**DUAL-SLOT PC CARD POWER-INTERFACE SWITCH**  
**WITH RESET FOR SERIAL PCMCIA CONTROLLER**

SLVS123B – SEPTEMBER 1995 – REVISED JANUARY 2001

**APPLICATION INFORMATION**



**Figure 24. Internal Switching Matrix**

**TPS2202AI**  
**DUAL-SLOT PC CARD POWER-INTERFACE SWITCH**  
**WITH RESET FOR SERIAL PCMCIA CONTROLLER**

SLVS123B – SEPTEMBER 1995 – REVISED JANUARY 2001

**APPLICATION INFORMATION**

**TPS2202AI control logic**

**AVPP**

CONTROL SIGNALS			INTERNAL SWITCH SETTINGS			OUTPUT
D8 SHDN	D0 A_VPP_PGM	D1 A_VPP_VCC	S7	S8	S9	VAVPP
1	0	0	CLOSED	OPEN	OPEN	0 V
1	0	1	OPEN	CLOSED	OPEN	VCC†
1	1	0	OPEN	OPEN	CLOSED	VPP(12 V)
1	1	1	OPEN	OPEN	OPEN	Hi-Z
0	X	X	OPEN	OPEN	OPEN	Hi-Z

**BVPP**

CONTROL SIGNALS			INTERNAL SWITCH SETTINGS			OUTPUT
D8 SHDN	D4 B_VPP_PGM	D5 B_VPP_VCC	S10	S11	S12	VBVPP
1	0	0	CLOSED	OPEN	OPEN	0 V
1	0	1	OPEN	CLOSED	OPEN	VCC‡
1	1	0	OPEN	OPEN	CLOSED	VPP(12 V)
1	1	1	OPEN	OPEN	OPEN	Hi-Z
0	X	X	OPEN	OPEN	OPEN	Hi-Z

**AVCC**

CONTROL SIGNALS			INTERNAL SWITCH SETTINGS			OUTPUT
D8 SHDN	D3 A_VCC3	D2 A_VCC5	S1	S2	S3	VAVCC
1	0	0	CLOSED	OPEN	OPEN	0 V
1	0	1	OPEN	CLOSED	OPEN	3.3 V
1	1	0	OPEN	OPEN	CLOSED	5 V
1	1	1	CLOSED	OPEN	OPEN	0 V
0	X	X	OPEN	OPEN	OPEN	Hi-Z

**BVCC**

CONTROL SIGNALS			INTERNAL SWITCH SETTINGS			OUTPUT
D8 SHDN	D6 B_VCC3	D7 B_VCC5	S4	S5	S6	VBVCC
1	0	0	CLOSED	OPEN	OPEN	0 V
1	0	1	OPEN	CLOSED	OPEN	3.3 V
1	1	0	OPEN	OPEN	CLOSED	5 V
1	1	1	CLOSED	OPEN	OPEN	0 V
0	X	X	OPEN	OPEN	OPEN	Hi-Z

† Output depends on AVCC

‡ Output depends on BVCC

**ESD protection**

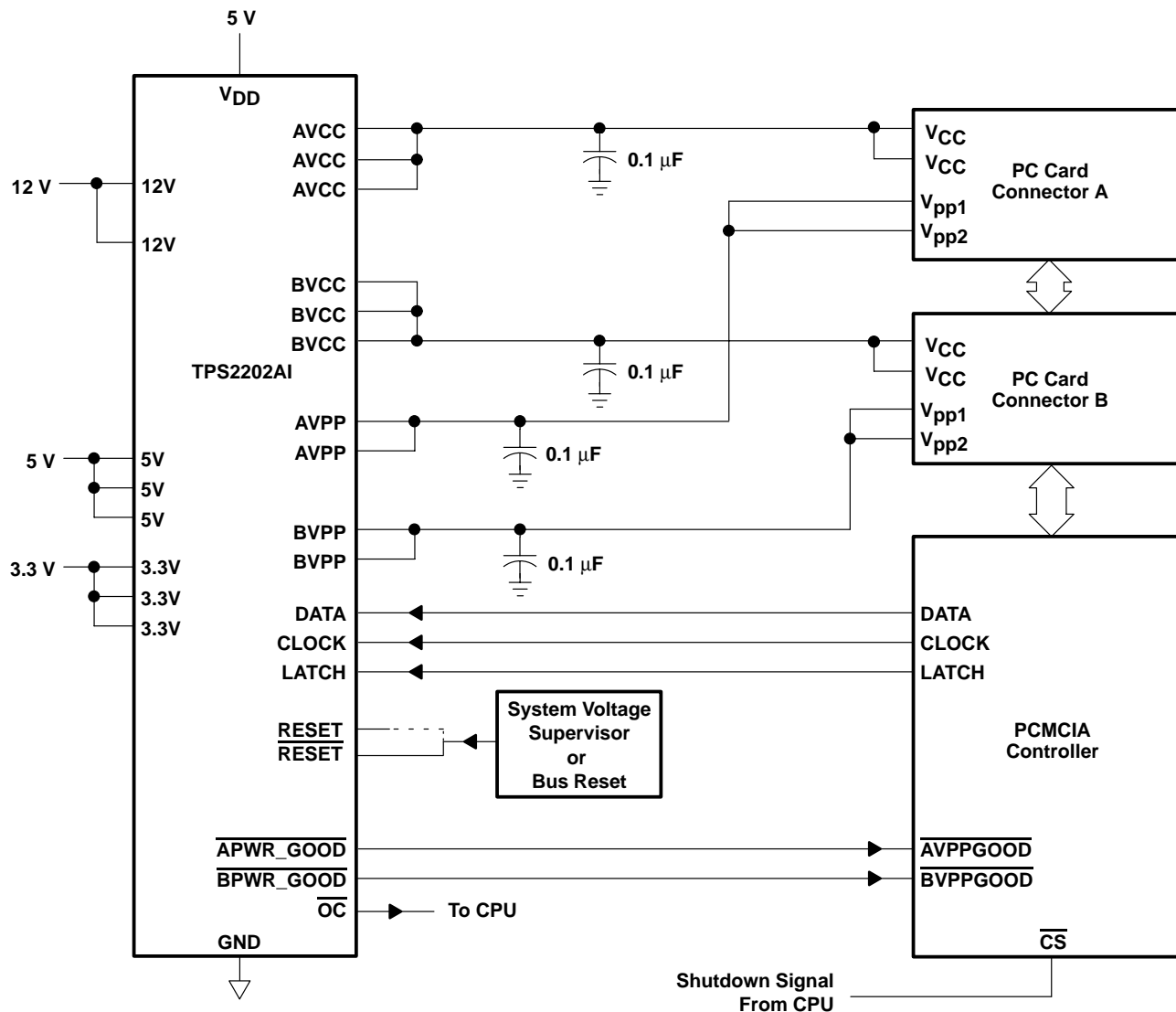
All TPS2202AI inputs and outputs incorporate ESD-protection circuitry designed to withstand a 2-kV human-body-model discharge as defined in MIL-STD-883C, Method 3015. The V<sub>CC</sub> and V<sub>pp</sub> outputs can be exposed to potentially higher discharges from the external environment through the PC Card connector. Bypassing the outputs with 0.1-μF capacitors protects the devices from discharges up to 10 kV.



**TPS2202AI**  
**DUAL-SLOT PC CARD POWER-INTERFACE SWITCH**  
**WITH RESET FOR SERIAL PCMCIA CONTROLLER**

SLVS123B – SEPTEMBER 1995 – REVISED JANUARY 2001

**APPLICATION INFORMATION**



**Figure 25. Detailed Interconnections and Capacitor Recommendations**

**PACKAGING INFORMATION**

Orderable Device	Status <sup>(1)</sup>	Package Type	Package Drawing	Pins	Package Qty	Eco Plan <sup>(2)</sup>	Lead/ Ball Finish	MSL Peak Temp <sup>(3)</sup>	Samples (Requires Login)
TPS2202AIDB	ACTIVE	SSOP	DB	30	50	Green (RoHS & no Sb/Br)	CU NIPDAU	Level-1-260C-UNLIM	
TPS2202AIDBG4	ACTIVE	SSOP	DB	30	50	Green (RoHS & no Sb/Br)	CU NIPDAU	Level-1-260C-UNLIM	
TPS2202AIDBLE	OBSOLETE	SSOP	DB	30		TBD	Call TI	Call TI	
TPS2202AIDBR	ACTIVE	SSOP	DB	30	2000	Green (RoHS & no Sb/Br)	CU NIPDAU	Level-1-260C-UNLIM	
TPS2202AIDBRG4	ACTIVE	SSOP	DB	30	2000	Green (RoHS & no Sb/Br)	CU NIPDAU	Level-1-260C-UNLIM	
TPS2202AIDF	OBSOLETE	SSOP	DF	30		TBD	Call TI	Call TI	
TPS2202AIDFLE	OBSOLETE	SSOP	DF	30		TBD	Call TI	Call TI	

<sup>(1)</sup> The marketing status values are defined as follows:

**ACTIVE:** Product device recommended for new designs.

**LIFEBUY:** TI has announced that the device will be discontinued, and a lifetime-buy period is in effect.

**NRND:** Not recommended for new designs. Device is in production to support existing customers, but TI does not recommend using this part in a new design.

**PREVIEW:** Device has been announced but is not in production. Samples may or may not be available.

**OBSOLETE:** TI has discontinued the production of the device.

<sup>(2)</sup> Eco Plan - The planned eco-friendly classification: Pb-Free (RoHS), Pb-Free (RoHS Exempt), or Green (RoHS & no Sb/Br) - please check <http://www.ti.com/productcontent> for the latest availability information and additional product content details.

**TBD:** The Pb-Free/Green conversion plan has not been defined.

**Pb-Free (RoHS):** TI's terms "Lead-Free" or "Pb-Free" mean semiconductor products that are compatible with the current RoHS requirements for all 6 substances, including the requirement that lead not exceed 0.1% by weight in homogeneous materials. Where designed to be soldered at high temperatures, TI Pb-Free products are suitable for use in specified lead-free processes.

**Pb-Free (RoHS Exempt):** This component has a RoHS exemption for either 1) lead-based flip-chip solder bumps used between the die and package, or 2) lead-based die adhesive used between the die and leadframe. The component is otherwise considered Pb-Free (RoHS compatible) as defined above.

**Green (RoHS & no Sb/Br):** TI defines "Green" to mean Pb-Free (RoHS compatible), and free of Bromine (Br) and Antimony (Sb) based flame retardants (Br or Sb do not exceed 0.1% by weight in homogeneous material)

<sup>(3)</sup> MSL, Peak Temp. -- The Moisture Sensitivity Level rating according to the JEDEC industry standard classifications, and peak solder temperature.

**Important Information and Disclaimer:** The information provided on this page represents TI's knowledge and belief as of the date that it is provided. TI bases its knowledge and belief on information provided by third parties, and makes no representation or warranty as to the accuracy of such information. Efforts are underway to better integrate information from third parties. TI has taken and continues to take reasonable steps to provide representative and accurate information but may not have conducted destructive testing or chemical analysis on incoming materials and chemicals. TI and TI suppliers consider certain information to be proprietary, and thus CAS numbers and other limited information may not be available for release.

In no event shall TI's liability arising out of such information exceed the total purchase price of the TI part(s) at issue in this document sold by TI to Customer on an annual basis.

**TAPE AND REEL INFORMATION**
**REEL DIMENSIONS**

**TAPE DIMENSIONS**


A0	Dimension designed to accommodate the component width
B0	Dimension designed to accommodate the component length
K0	Dimension designed to accommodate the component thickness
W	Overall width of the carrier tape
P1	Pitch between successive cavity centers

**TAPE AND REEL INFORMATION**

\*All dimensions are nominal

Device	Package Type	Package Drawing	Pins	SPQ	Reel Diameter (mm)	Reel Width W1 (mm)	A0 (mm)	B0 (mm)	K0 (mm)	P1 (mm)	W (mm)	Pin1 Quadrant
TPS2202AIDBR	SSOP	DB	30	2000	330.0	16.4	8.2	10.5	2.5	12.0	16.0	Q1

**TAPE AND REEL BOX DIMENSIONS**



\*All dimensions are nominal

Device	Package Type	Package Drawing	Pins	SPQ	Length (mm)	Width (mm)	Height (mm)
TPS2202AIDBR	SSOP	DB	30	2000	367.0	367.0	38.0



## IMPORTANT NOTICE

Texas Instruments Incorporated and its subsidiaries (TI) reserve the right to make corrections, enhancements, improvements and other changes to its semiconductor products and services per JESD46C and to discontinue any product or service per JESD48B. Buyers should obtain the latest relevant information before placing orders and should verify that such information is current and complete. All semiconductor products (also referred to herein as "components") are sold subject to TI's terms and conditions of sale supplied at the time of order acknowledgment.

TI warrants performance of its components to the specifications applicable at the time of sale, in accordance with the warranty in TI's terms and conditions of sale of semiconductor products. Testing and other quality control techniques are used to the extent TI deems necessary to support this warranty. Except where mandated by applicable law, testing of all parameters of each component is not necessarily performed.

TI assumes no liability for applications assistance or the design of Buyers' products. Buyers are responsible for their products and applications using TI components. To minimize the risks associated with Buyers' products and applications, Buyers should provide adequate design and operating safeguards.

TI does not warrant or represent that any license, either express or implied, is granted under any patent right, copyright, mask work right, or other intellectual property right relating to any combination, machine, or process in which TI components or services are used. Information published by TI regarding third-party products or services does not constitute a license to use such products or services or a warranty or endorsement thereof. Use of such information may require a license from a third party under the patents or other intellectual property of the third party, or a license from TI under the patents or other intellectual property of TI.

Reproduction of significant portions of TI information in TI data books or data sheets is permissible only if reproduction is without alteration and is accompanied by all associated warranties, conditions, limitations, and notices. TI is not responsible or liable for such altered documentation. Information of third parties may be subject to additional restrictions.

Resale of TI components or services with statements different from or beyond the parameters stated by TI for that component or service voids all express and any implied warranties for the associated TI component or service and is an unfair and deceptive business practice. TI is not responsible or liable for any such statements.

Buyer acknowledges and agrees that it is solely responsible for compliance with all legal, regulatory and safety-related requirements concerning its products, and any use of TI components in its applications, notwithstanding any applications-related information or support that may be provided by TI. Buyer represents and agrees that it has all the necessary expertise to create and implement safeguards which anticipate dangerous consequences of failures, monitor failures and their consequences, lessen the likelihood of failures that might cause harm and take appropriate remedial actions. Buyer will fully indemnify TI and its representatives against any damages arising out of the use of any TI components in safety-critical applications.

In some cases, TI components may be promoted specifically to facilitate safety-related applications. With such components, TI's goal is to help enable customers to design and create their own end-product solutions that meet applicable functional safety standards and requirements. Nonetheless, such components are subject to these terms.

No TI components are authorized for use in FDA Class III (or similar life-critical medical equipment) unless authorized officers of the parties have executed a special agreement specifically governing such use.

Only those TI components which TI has specifically designated as military grade or "enhanced plastic" are designed and intended for use in military/aerospace applications or environments. Buyer acknowledges and agrees that any military or aerospace use of TI components which have **not** been so designated is solely at the Buyer's risk, and that Buyer is solely responsible for compliance with all legal and regulatory requirements in connection with such use.

TI has specifically designated certain components which meet ISO/TS16949 requirements, mainly for automotive use. Components which have not been so designated are neither designed nor intended for automotive use; and TI will not be responsible for any failure of such components to meet such requirements.

### Products

Audio	<a href="http://www.ti.com/audio">www.ti.com/audio</a>
Amplifiers	<a href="http://amplifier.ti.com">amplifier.ti.com</a>
Data Converters	<a href="http://dataconverter.ti.com">dataconverter.ti.com</a>
DLP® Products	<a href="http://www.dlp.com">www.dlp.com</a>
DSP	<a href="http://dsp.ti.com">dsp.ti.com</a>
Clocks and Timers	<a href="http://www.ti.com/clocks">www.ti.com/clocks</a>
Interface	<a href="http://interface.ti.com">interface.ti.com</a>
Logic	<a href="http://logic.ti.com">logic.ti.com</a>
Power Mgmt	<a href="http://power.ti.com">power.ti.com</a>
Microcontrollers	<a href="http://microcontroller.ti.com">microcontroller.ti.com</a>
RFID	<a href="http://www.ti-rfid.com">www.ti-rfid.com</a>
OMAP Mobile Processors	<a href="http://www.ti.com/omap">www.ti.com/omap</a>
Wireless Connectivity	<a href="http://www.ti.com/wirelessconnectivity">www.ti.com/wirelessconnectivity</a>

### Applications

Automotive and Transportation	<a href="http://www.ti.com/automotive">www.ti.com/automotive</a>
Communications and Telecom	<a href="http://www.ti.com/communications">www.ti.com/communications</a>
Computers and Peripherals	<a href="http://www.ti.com/computers">www.ti.com/computers</a>
Consumer Electronics	<a href="http://www.ti.com/consumer-apps">www.ti.com/consumer-apps</a>
Energy and Lighting	<a href="http://www.ti.com/energy">www.ti.com/energy</a>
Industrial	<a href="http://www.ti.com/industrial">www.ti.com/industrial</a>
Medical	<a href="http://www.ti.com/medical">www.ti.com/medical</a>
Security	<a href="http://www.ti.com/security">www.ti.com/security</a>
Space, Avionics and Defense	<a href="http://www.ti.com/space-avionics-defense">www.ti.com/space-avionics-defense</a>
Video and Imaging	<a href="http://www.ti.com/video">www.ti.com/video</a>

**TI E2E Community** [e2e.ti.com](http://e2e.ti.com)



**Стандарт  
Электрон  
Связь**

Мы молодая и активно развивающаяся компания в области поставок электронных компонентов. Мы поставляем электронные компоненты отечественного и импортного производства напрямую от производителей и с крупнейших складов мира.

Благодаря сотрудничеству с мировыми поставщиками мы осуществляем комплексные и плановые поставки широчайшего спектра электронных компонентов.

Собственная эффективная логистика и склад в обеспечивает надежную поставку продукции в точно указанные сроки по всей России.

Мы осуществляем техническую поддержку нашим клиентам и предпродажную проверку качества продукции. На все поставляемые продукты мы предоставляем гарантию .

Осуществляем поставки продукции под контролем ВП МО РФ на предприятия военно-промышленного комплекса России , а также работаем в рамках 275 ФЗ с открытием отдельных счетов в уполномоченном банке. Система менеджмента качества компании соответствует требованиям ГОСТ ISO 9001.

Минимальные сроки поставки, гибкие цены, неограниченный ассортимент и индивидуальный подход к клиентам являются основой для выстраивания долгосрочного и эффективного сотрудничества с предприятиями радиоэлектронной промышленности, предприятиями ВПК и научно-исследовательскими институтами России.

С нами вы становитесь еще успешнее!

**Наши контакты:**

**Телефон:** +7 812 627 14 35

**Электронная почта:** [sales@st-electron.ru](mailto:sales@st-electron.ru)

**Адрес:** 198099, Санкт-Петербург,  
Промышленная ул, дом № 19, литера Н,  
помещение 100-Н Офис 331