

MAX17502G Evaluation Kit

Evaluates: MAX17502G in TDFN Package

General Description

The MAX17502G EV kit provides a proven design to evaluate the MAX17502G high-efficiency, high-voltage, synchronous step-down DC-DC converter in a TDFN package. The EV kit generates 12V at load currents up to 1A from a 15V to 60V input supply. The EV kit features a 600kHz fixed switching frequency for optimum efficiency and component size. The EV kit features a forced-PWM control scheme that provides constant switching-frequency operation at all load and line conditions.

Features

- ◆ Operates from a 15V to 60V Input Supply
- ◆ 12V Output Voltage
- ◆ 1A Output Current
- ◆ 600kHz Switching Frequency
- ◆ Enable/UVLO Input
- ◆ Resistor-Programmable UVLO Threshold
- ◆ Open-Drain RESET Output
- ◆ Overcurrent and Overtemperature Protection
- ◆ Proven PCB Layout
- ◆ Fully Assembled and Tested

[Ordering Information](#) appears at end of data sheet.

Component List

DESIGNATION	QTY	DESCRIPTION
C1	1	2.2 μ F \pm 10%, 100V X7R ceramic capacitor (1210) Murata GRM32ER72A225KA
C2	1	1 μ F \pm 10%, 6.3V X7R ceramic capacitor (0603) Murata GRM188R70J105K
C3	1	6800pF \pm 10%, 25V X7R ceramic capacitor (0402) Murata GRM155R71E682K
C4	1	10 μ F \pm 10%, 16V X7R ceramic capacitor (1210) Murata GRM32DR71C106K
C5	1	2200pF \pm 10%, 50V X7R ceramic capacitor (0402) Murata GRM155R71H222K
C7	1	33 μ F, 80V aluminum electrolytic (D = 8mm) Panasonic EEEFK1K330P
C8	0	Not installed, ceramic capacitor (1210)

DESIGNATION	QTY	DESCRIPTION
C9	1	12pF \pm 5%, 50V C0G ceramic capacitor (0402) Murata GRM1555C1H120J
JU1	1	3-pin header
L1	1	47 μ H, 2A inductor (10.5mm x 10.2mm x 3.8mm) Coilcraft MSS1038-473ML
R1	1	3.32M Ω \pm 1% resistor (0402)
R2	1	316k Ω \pm 1% resistor (0402)
R3	1	20k Ω \pm 1% resistor (0402)
R4	1	174k Ω \pm 1% resistor (0402)
R5	1	14k Ω \pm 1% resistor (0402)
R6	1	100k Ω \pm 1% resistor (0402)
R7	1	71.5k Ω \pm 1% resistor (0402)
TP1, TP2	0	Not installed, test points
U1	1	Buck converter (10 TDFN-EP*) Maxim MAX17502GATB+
—	1	Shunt
—	1	PCB: MAX17502GT EVALUATION KIT

*EP = Exposed pad.

MAX17502G Evaluation Kit

Evaluates: MAX17502G in TDFN Package

Component Suppliers

SUPPLIER	PHONE	WEBSITE
Coilcraft, Inc.	847-639-6400	www.coilcraft.com
Murata Electronics North America, Inc.	770-436-1300	www.murata-northamerica.com
Panasonic Corp.	800-344-2112	www.panasonic.com

Note: Indicate that you are using the MAX17502 when contacting these component suppliers.

Quick Start

Recommended Equipment

- MAX17502G EV kit
- 15V to 60V, 2A DC input power supply
- Load capable of sinking 1A
- Digital voltmeter (DVM)
- Function generator

Procedure

The EV kit is fully assembled and tested. Follow the steps below to verify the board operation. **Caution: Do not turn on power supply until all connections are completed.**

- 1) Set the power supply at a voltage between 15V and 60V. Disable the power supply.
- 2) Connect the positive terminal of the power supply to the VIN PCB pad and the negative terminal to the nearest PGND PCB pad. Connect the positive terminal of the 1A load to the VOUT PCB pad and the negative terminal to the nearest PGND PCB pad.
- 3) Connect the DVM across the VOUT PCB pad and the nearest PGND PCB pad.
- 4) Turn on the DC power supply.
- 5) Enable the load.
- 6) Verify that the DVM displays 12V.

To turn-on/off the part from EN/UVLO, follow the steps below:

- 1) Remove resistors R1 and R2.
- 2) Connect the power supply to the EV kit and turn on the power supply. Set the power supply at a voltage between 15V and 60V.

- 3) Connect the function generator output to the EN/UVLO test loop.
- 4) EN/UVLO rising threshold is 1.24V and falling threshold is 1.11V. Make sure that the voltage-high and voltage-low levels of the function generator output are greater than 1.24V and less than 1.11V, respectively.
- 5) While powering down the EV kit, first disconnect the function generator output from the EN/UVLO test loop and then turn off the DC power supply.

Detailed Description of Hardware

The MAX17502G EV kit provides a proven design to evaluate the MAX17502G high-efficiency, high-voltage, synchronous step-down DC-DC converter in a TDFN package. The EV kit generates 12V at load currents up to 1A from a 15V to 60V input supply. The EV kit features a 600kHz fixed switching frequency for optimum efficiency and component size. The EV kit features a forced-PWM control scheme that provides constant switching-frequency operation at all load and line conditions.

The EV kit includes an EN/UVLO PCB pad to enable control of the converter output. An additional RESET PCB pad is available for monitoring the open-drain logic output. The VCC PCB pad helps measure the internal LDO voltage.

Soft-Start Input (SS)

The device utilizes an adjustable soft-start function to limit inrush current during startup. The soft-start time is adjusted by the value of C3, the external capacitor from SS to GND. To adjust the soft-start time, determine C3 using the following formula:

$$C3 = 5.55 \times t_{SS}$$

where t_{SS} is the required soft-start time in milliseconds and C3 is in nanofarads.

MAX17502G Evaluation Kit

Evaluates: MAX17502G in TDFN Package

Regulator Enable/Undervoltage-Lockout Level (EN/UVLO)

The device features an EN/UVLO input. For normal operation, no shunts should be installed across pins 1-2 or 2-3 on jumper JU1. To disable the output, install a shunt across pins 2-3 on JU1 and the EN/UVLO pin is pulled to GND. See Table 1 for JU1 settings.

Setting the Undervoltage-Lockout Level

The device offers an adjustable input undervoltage-lockout level. Set the voltage at which the device turns on with a resistive voltage-divider connected from VIN to GND (see Figure 1). Connect the center node of the divider to EN/UVLO.

Choose R1 to be 3.3MΩ and then calculate R2 as follows:

$$R2 = \frac{R1 \times 1.218}{(V_{INU} - 1.218)}$$

where V_{INU} is the voltage at which the device is required to turn on. Ensure that V_{INU} is higher than $0.8 \times V_{OUT}$.

Adjusting the Output Voltage

The device offers an adjustable output voltage. Set the output voltage with a resistive voltage-divider connected from the positive terminal of the output capacitor (V_{OUT}) to GND (see Figure 6). Connect the center node of the voltage-divider to FB.

To choose the values of R4 and R5, select the parallel combination of R4 and R5, with R_P less than 15kΩ. Once R_P is selected, calculate R4 as follows:

$$R4 = \frac{R_P \times V_{OUT}}{0.9}$$

Calculate R5 as follows:

$$R5 = \frac{R4 \times 0.9}{(V_{OUT} - 0.9)}$$

Table 1. Regulator Enable (EN/UVLO) Jumper JU1 Settings

SHUNT POSITION	EN/UVLO PIN	MAX17502G OUTPUT
Not installed*	Connected to the center node of resistor-divider R1 and R2	Enabled, UVLO level set through the R1 and R2 resistor-divider
2-3	Connected to GND	Disabled

*Default position.

EV Kit Performance Report

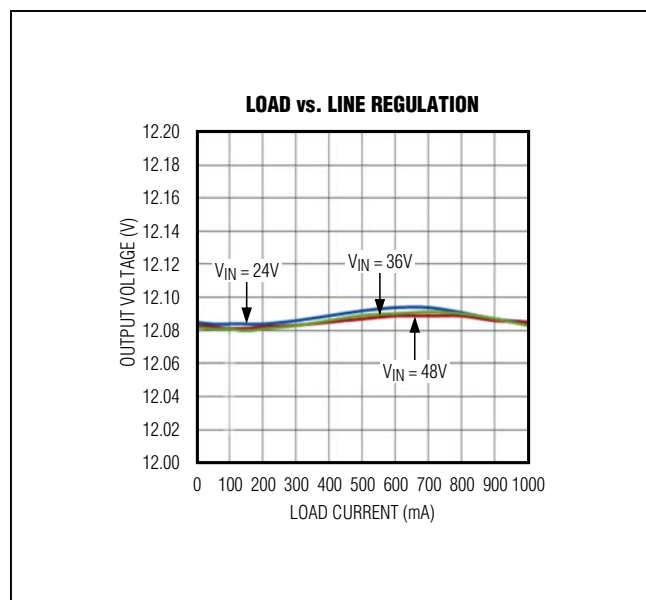

Figure 1. MAX17502G Load and Line Regulation

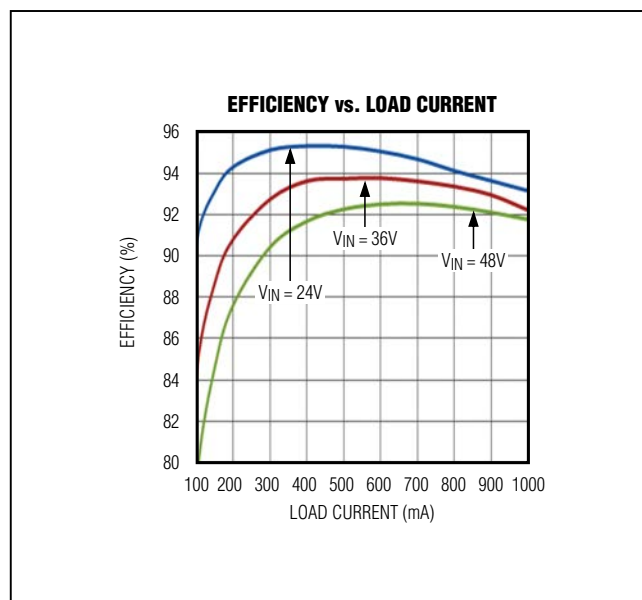

Figure 2. MAX17502G Load and Line Regulation

MAX17502G Evaluation Kit

Evaluates: MAX17502G in TDFN Package

EV Kit Performance Report (continued)

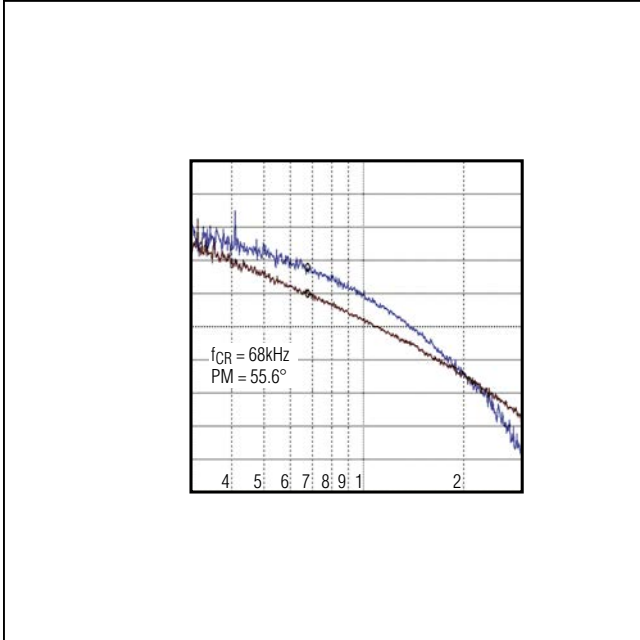

Figure 3. MAX17502G Full-Load Bode Plot ($V_{IN} = 24\text{V}$)

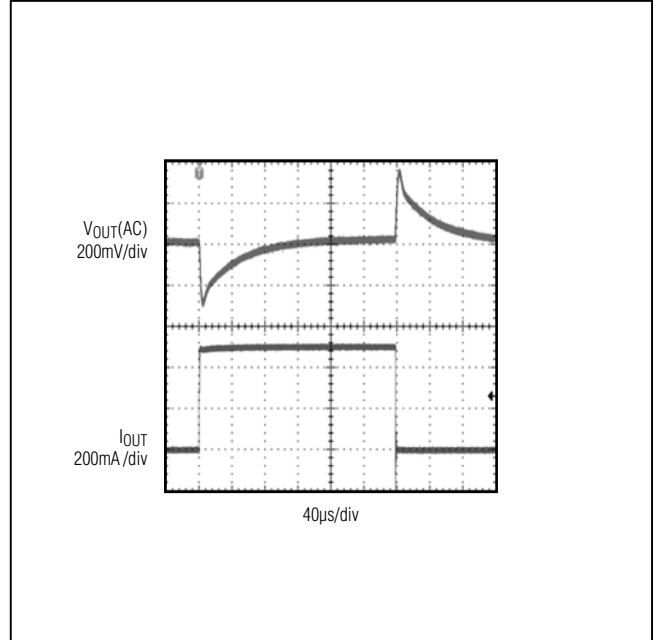

Figure 4. MAX17502G No Load to 500mA Load Transient

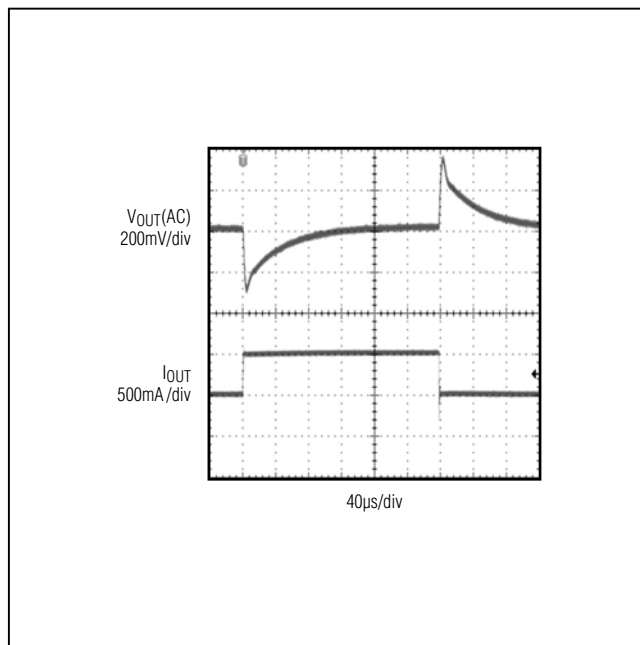

Figure 5. MAX17502G 500mA to 1A Load Transient

MAX17502G Evaluation Kit

Evaluates: MAX17502G in TDFN Package

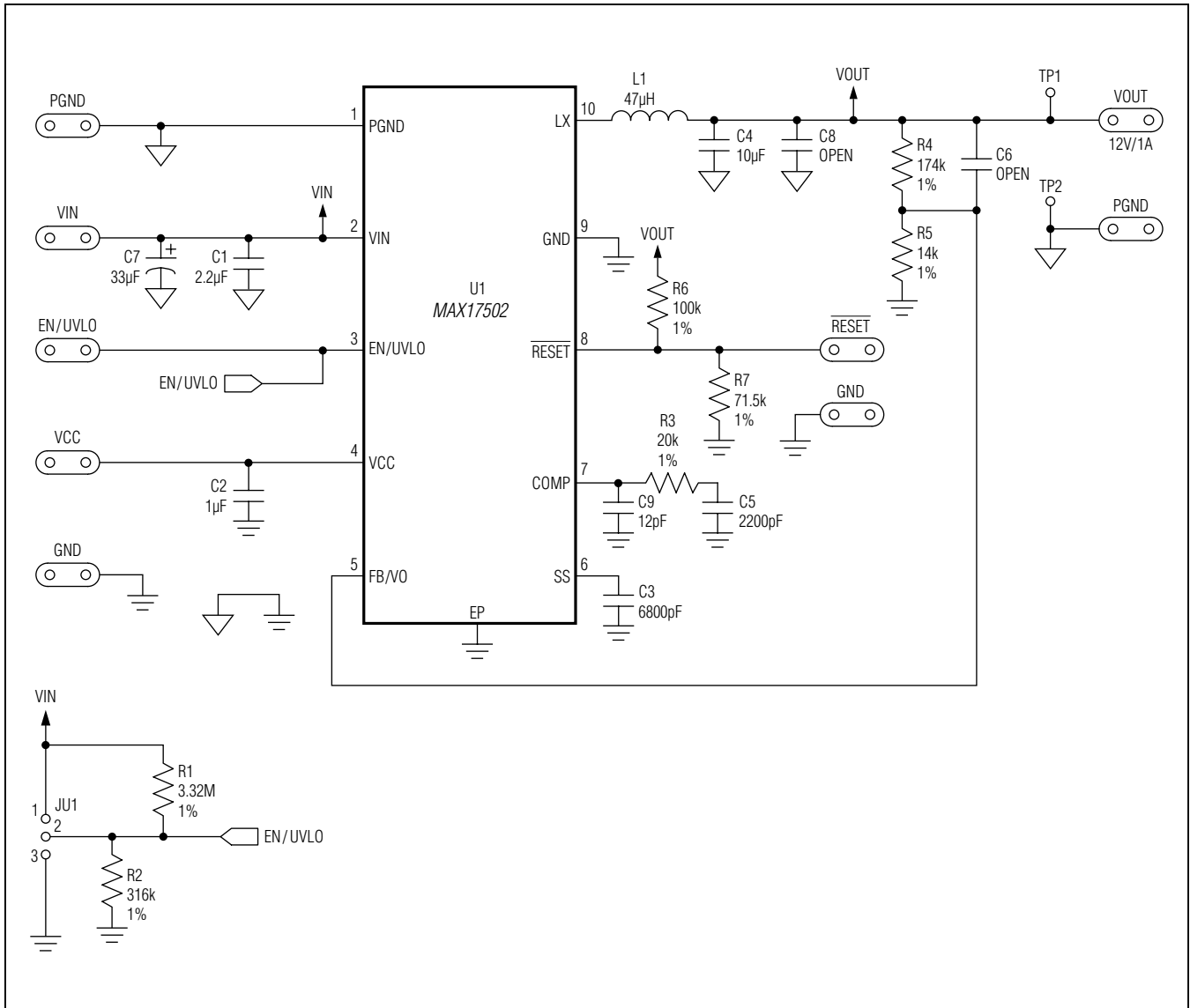

Figure 6. MAX17502G EV Kit Schematic

MAX17502G Evaluation Kit

Evaluates: MAX17502G in TDFN Package

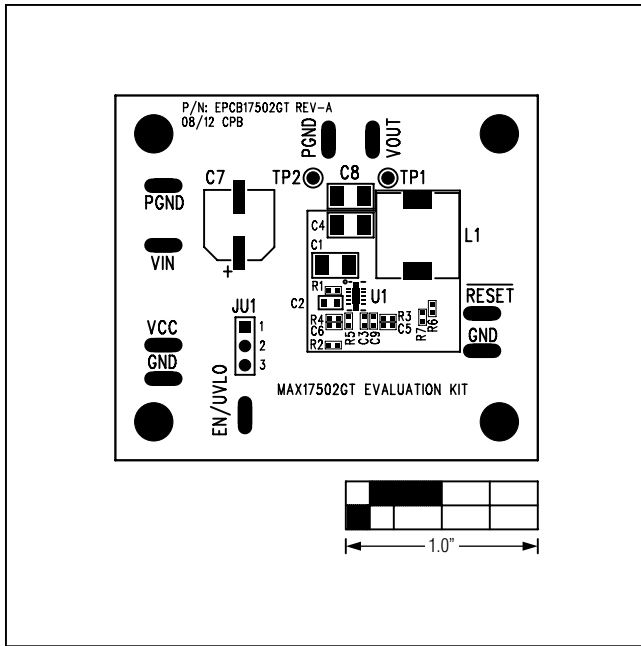

Figure 7. MAX17502G EV Kit Component Placement Guide—Component Side

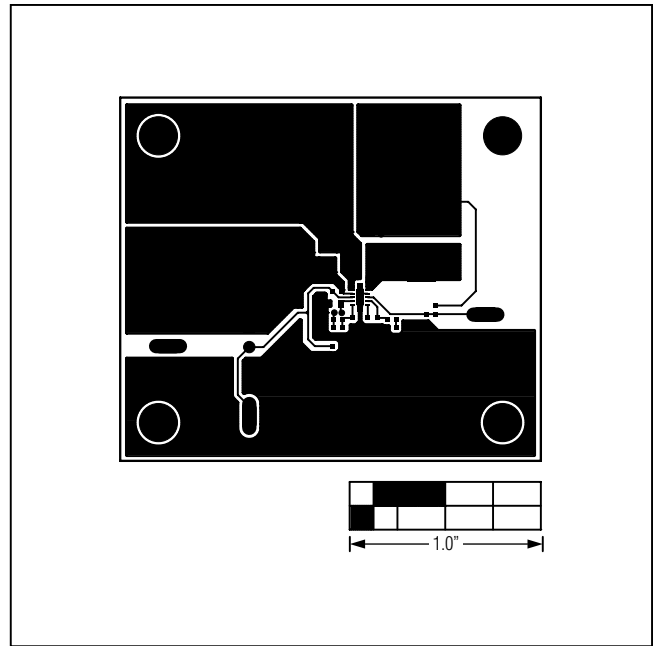

Figure 8. MAX17502G EV Kit PCB Layout—Component Side

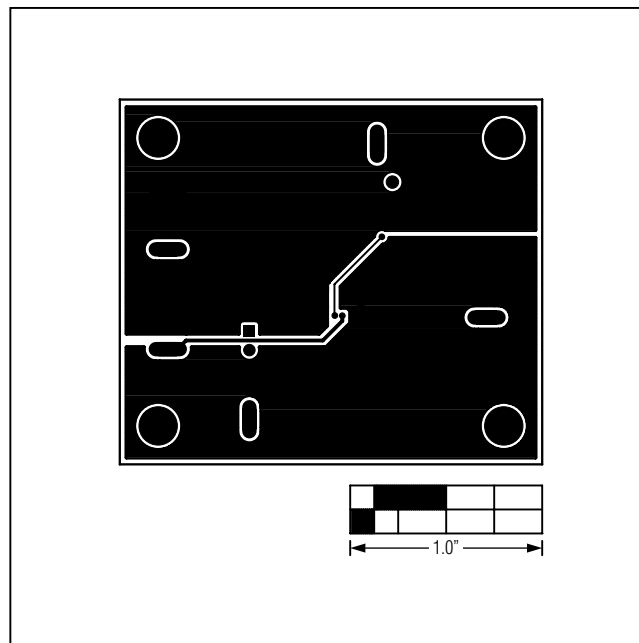

Figure 9. MAX17502G EV Kit PCB Layout—Solder Side

MAX17502G Evaluation Kit

Evaluates: MAX17502G in TDFN Package

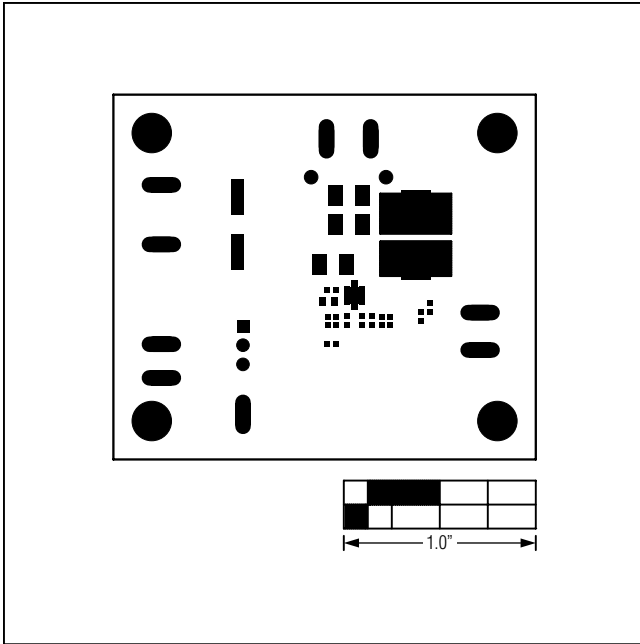

Figure 10. MAX17502G EV Kit Component Placement Guide—Top Solder Mask

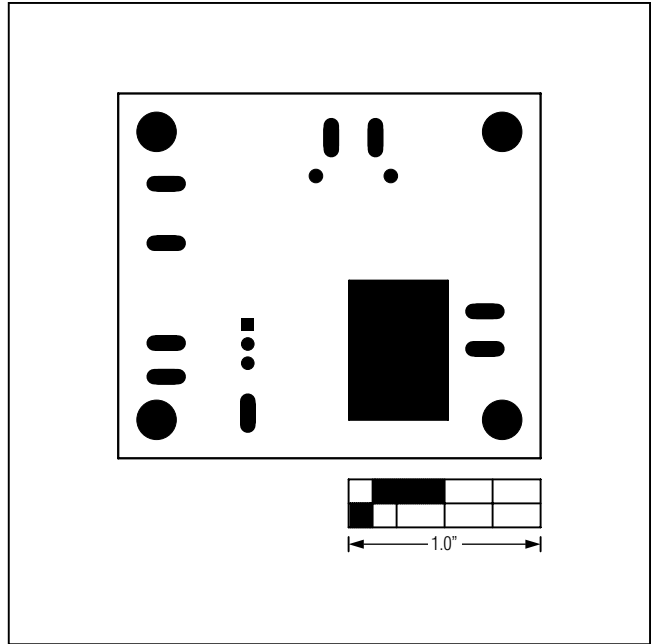

Figure 11. MAX17502G EV Kit Component Placement Guide—Bottom Solder Mask

Ordering Information

PART	TYPE
MAX17502GTEVKIT#	EV Kit

#Denotes RoHS compliant.

MAX17502G Evaluation Kit

Evaluates: MAX17502G in TDFN Package

Revision History

REVISION NUMBER	REVISION DATE	DESCRIPTION	PAGES CHANGED
0	11/12	Initial release	—



Maxim Integrated cannot assume responsibility for use of any circuitry other than circuitry entirely embodied in a Maxim Integrated product. No circuit patent licenses are implied. Maxim Integrated reserves the right to change the circuitry and specifications without notice at any time. The parametric values (min and max limits) shown in the Electrical Characteristics table are guaranteed. Other parametric values quoted in this data sheet are provided for guidance.

Maxim Integrated 160 Rio Robles, San Jose, CA 95134 USA 1-408-601-1000

8



Стандарт Электрон Связь

Мы молодая и активно развивающаяся компания в области поставок электронных компонентов. Мы поставляем электронные компоненты отечественного и импортного производства напрямую от производителей и с крупнейших складов мира.

Благодаря сотрудничеству с мировыми поставщиками мы осуществляем комплексные и плановые поставки широчайшего спектра электронных компонентов.

Собственная эффективная логистика и склад в обеспечивает надежную поставку продукции в точно указанные сроки по всей России.

Мы осуществляем техническую поддержку нашим клиентам и предпродажную проверку качества продукции. На все поставляемые продукты мы предоставляем гарантию .

Осуществляем поставки продукции под контролем ВП МО РФ на предприятия военно-промышленного комплекса России , а также работаем в рамках 275 ФЗ с открытием отдельных счетов в уполномоченном банке. Система менеджмента качества компании соответствует требованиям ГОСТ ISO 9001.

Минимальные сроки поставки, гибкие цены, неограниченный ассортимент и индивидуальный подход к клиентам являются основой для выстраивания долгосрочного и эффективного сотрудничества с предприятиями радиоэлектронной промышленности, предприятиями ВПК и научно-исследовательскими институтами России.

С нами вы становитесь еще успешнее!

Наши контакты:

Телефон: +7 812 627 14 35

Электронная почта: sales@st-electron.ru

Адрес: 198099, Санкт-Петербург,
Промышленная ул, дом № 19, литера Н,
помещение 100-Н Офис 331