

N-Channel MOSFET

Power MOS 8™ is a high speed, high voltage N-channel switch-mode power MOSFET. A proprietary planar stripe design yields excellent reliability and manufacturability. Low switching loss is achieved with low input capacitance and ultra low C_{rss} "Miller" capacitance. The intrinsic gate resistance and capacitance of the poly-silicon gate structure help control slew rates during switching, resulting in low EMI and reliable paralleling, even when switching at very high frequency. Reliability in flyback, boost, forward, and other circuits is enhanced by the high avalanche energy capability.

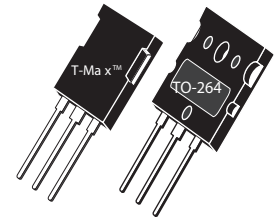

APT28M120B2

APT28M120L

Single die MOSFET

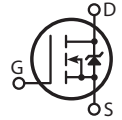

FEATURES

- Fast switching with low EMI/RFI
- Low $R_{DS(on)}$
- Ultra low C_{rss} for improved noise immunity
- Low gate charge
- Avalanche energy rated
- RoHS compliant 

TYPICAL APPLICATIONS

- PFC and other boost converter
- Buck converter
- Two switch forward (asymmetrical bridge)
- Single switch forward
- Flyback
- Inverters

Absolute Maximum Ratings

| Symbol | Parameter | Ratings | Unit |
|----------|--|---------|------|
| I_D | Continuous Drain Current @ $T_C = 25^\circ\text{C}$ | 29 | A |
| | Continuous Drain Current @ $T_C = 100^\circ\text{C}$ | 18 | |
| I_{DM} | Pulsed Drain Current ^① | 104 | |
| V_{GS} | Gate-Source Voltage | ±30 | V |
| E_{AS} | Single Pulse Avalanche Energy ^② | 2165 | mJ |
| I_{AR} | Avalanche Current, Repetitive or Non-Repetitive | 14 | A |

Thermal and Mechanical Characteristics

| Symbol | Characteristic | Min | Typ | Max | Unit |
|-----------------|--|-----|------|------|--------|
| P_D | Total Power Dissipation @ $T_C = 25^\circ\text{C}$ | | | 1135 | W |
| $R_{\theta JC}$ | Junction to Case Thermal Resistance | | | 0.11 | °C/W |
| $R_{\theta CS}$ | Case to Sink Thermal Resistance, Flat, Greased Surface | | 0.11 | | |
| T_J, T_{STG} | Operating and Storage Junction Temperature Range | -55 | | 150 | °C |
| T_L | Soldering Temperature for 10 Seconds (1.6mm from case) | | | 300 | |
| W_T | Package Weight | | 0.22 | | oz |
| | | | | 6.2 | g |
| Torque | Mounting Torque (TO-264 Package), 4-40 or M3 screw | | | 10 | in·lbf |
| | | | | 1.1 | N·m |

Static Characteristics
T_J = 25°C unless otherwise specified
APT28M120B2_L

| Symbol | Parameter | Test Conditions | Min | Typ | Max | Unit |
|--|---|--|------|------|------|-------|
| V _{BR(DSS)} | Drain-Source Breakdown Voltage | V _{GS} = 0V, I _D = 250μA | 1200 | | | V |
| ΔV _{BR(DSS)} /ΔT _J | Breakdown Voltage Temperature Coefficient | Reference to 25°C, I _D = 250μA | | 1.41 | | V/°C |
| R _{DS(on)} | Drain-Source On Resistance ^③ | V _{GS} = 10V, I _D = 14A | | 0.45 | 0.53 | Ω |
| V _{GS(th)} | Gate-Source Threshold Voltage | V _{GS} = V _{DS} , I _D = 2.5mA | 3 | 4 | 5 | V |
| ΔV _{GS(th)} /ΔT _J | Threshold Voltage Temperature Coefficient | | | -10 | | mV/°C |
| I _{DSS} | Zero Gate Voltage Drain Current | V _{DS} = 1200V V _{GS} = 0V | | | 100 | μA |
| | | T _J = 25°C T _J = 125°C | | | 500 | |
| I _{GSS} | Gate-Source Leakage Current | V _{GS} = ±30V | | | ±100 | nA |

Dynamic Characteristics
T_J = 25°C unless otherwise specified

| Symbol | Parameter | Test Conditions | Min | Typ | Max | Unit |
|---------------------------------|--|--|-----|------|-----|------|
| g _{fs} | Forward Transconductance | V _{DS} = 50V, I _D = 14A | | 31 | | S |
| C _{iss} | Input Capacitance | V _{GS} = 0V, V _{DS} = 25V f = 1MHz | | 9670 | | pF |
| C _{rss} | Reverse Transfer Capacitance | | | 115 | | |
| C _{oss} | Output Capacitance | | | 715 | | |
| C _{o(cr)} ^④ | Effective Output Capacitance, Charge Related | V _{GS} = 0V, V _{DS} = 0V to 800V | | 275 | | pF |
| C _{o(er)} ^⑤ | Effective Output Capacitance, Energy Related | | | 140 | | |
| Q _g | Total Gate Charge | V _{GS} = 0 to 10V, I _D = 14A, V _{DS} = 600V | | 300 | | nC |
| Q _{gs} | Gate-Source Charge | | | 50 | | |
| Q _{gd} | Gate-Drain Charge | | | 140 | | |
| t _{d(on)} | Turn-On Delay Time | Resistive Switching V _{DD} = 800V, I _D = 14A R _G = 2.2Ω ^⑥ , V _{GG} = 15V | | 50 | | ns |
| t _r | Current Rise Time | | | 31 | | |
| t _{d(off)} | Turn-Off Delay Time | | | 170 | | |
| t _f | Current Fall Time | | | 48 | | |

Source-Drain Diode Characteristics

| Symbol | Parameter | Test Conditions | Min | Typ | Max | Unit |
|-----------------|---|---|-----|------|-----|------|
| I _S | Continuous Source Current (Body Diode) | MOSFET symbol showing the integral reverse p-n junction diode (body diode) | | | 29 | A |
| I _{SM} | Pulsed Source Current (Body Diode) ^① | | | | 104 | |
| V _{SD} | Diode Forward Voltage | I _{SD} = 14A, T _J = 25°C, V _{GS} = 0V | | | 1 | V |
| t _{rr} | Reverse Recovery Time | I _{SD} = 14A ^② | | 1290 | | ns |
| Q _{rr} | Reverse Recovery Charge | di _{SD} /dt = 100A/μs, T _J = 25°C | | 33 | | μC |
| dv/dt | Peak Recovery dv/dt | I _{SD} ≤ 14A, di/dt ≤ 1000A/μs, V _{DD} = 100V, T _J = 125°C | | | 10 | V/ns |

① Repetitive Rating: Pulse width and case temperature limited by maximum junction temperature.

② Starting at T_J = 25°C, L = 22.09mH, R_G = 2.2Ω, I_{AS} = 14A.

③ Pulse test: Pulse Width < 380μs, duty cycle < 2%.

④ C_{o(cr)} is defined as a fixed capacitance with the same stored charge as C_{OSS} with V_{DS} = 67% of V_{(BR)DSS}.

⑤ C_{o(er)} is defined as a fixed capacitance with the same stored energy as C_{OSS} with V_{DS} = 67% of V_{(BR)DSS}. To calculate C_{o(er)} for any value of V_{DS} less than V_{(BR)DSS}, use this equation: C_{o(er)} = -4.40E-7/V_{DS}² + 5.34E-8/V_{DS} + 7.59E-11.

⑥ R_G is external gate resistance, not including internal gate resistance or gate driver impedance. (MIC4452)

Microsemi reserves the right to change, without notice, the specifications and information contained herein.

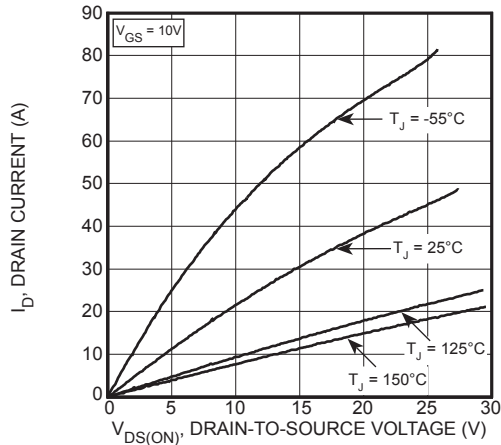

Figure 1, Output Characteristics

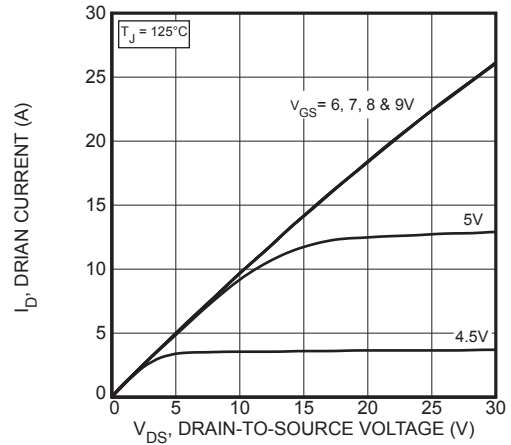

Figure 2, Output Characteristics

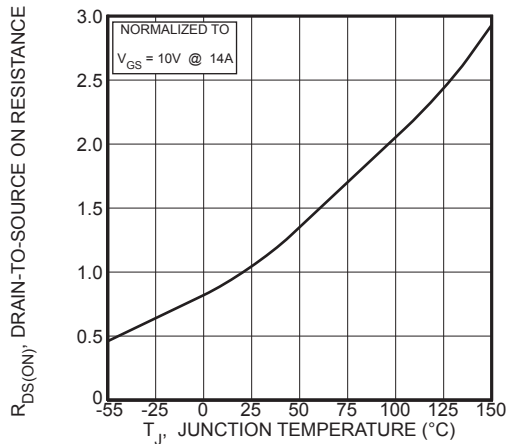

Figure 3, $R_{DS(ON)}$ vs Junction Temperature

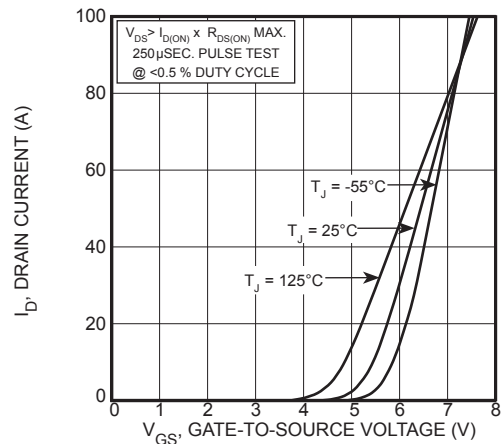

Figure 4, Transfer Characteristics

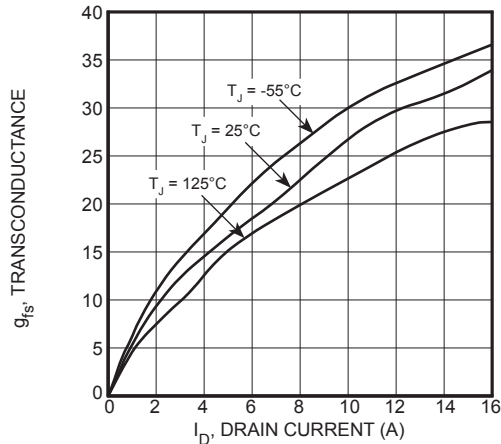

Figure 5, Gain vs Drain Current

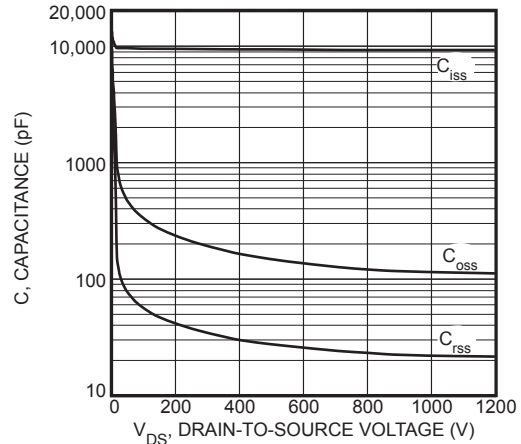

Figure 6, Capacitance vs Drain-to-Source Voltage

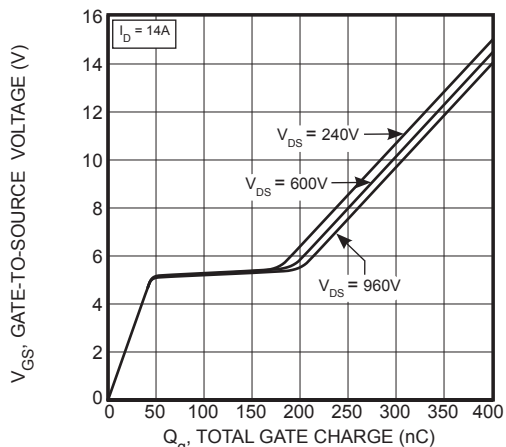

Figure 7, Gate Charge vs Gate-to-Source Voltage

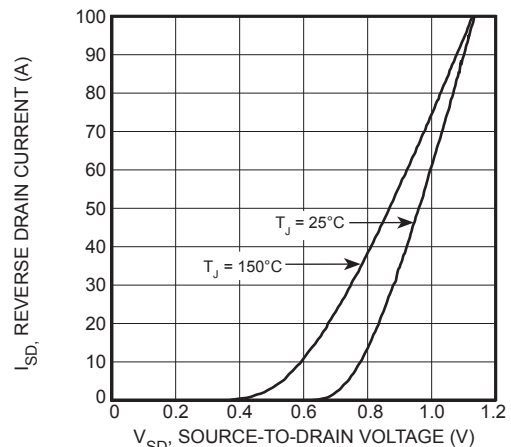
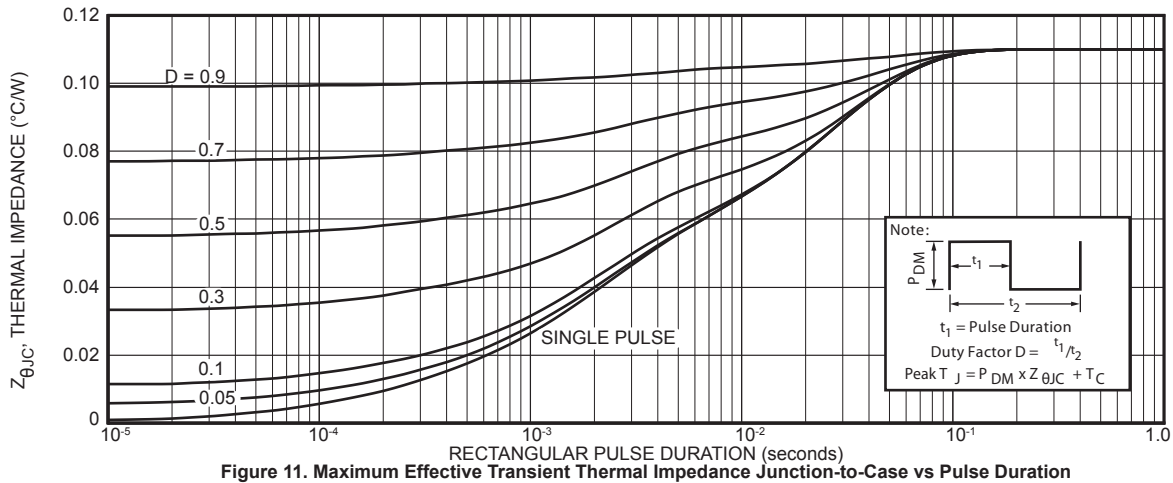
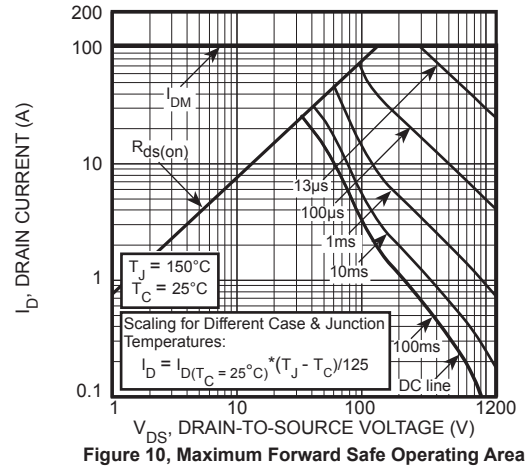
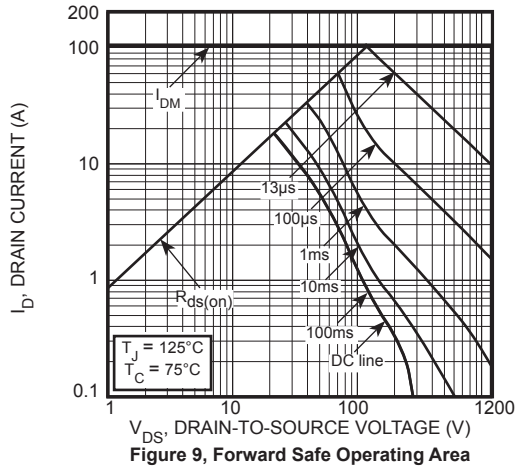

Figure 8, Reverse Drain Current vs Source-to-Drain Voltage



T-MAX® (B2) Package Outline

TO-264 (L) Package Outline

Ⓜ 100% Sn Plated

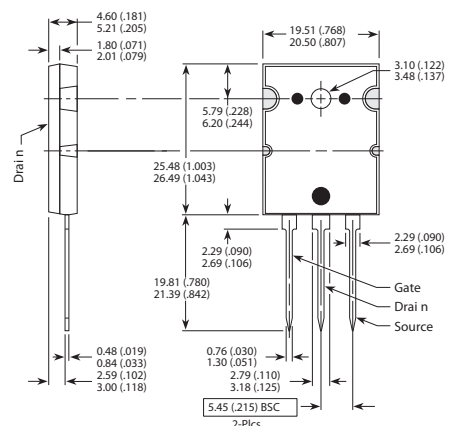
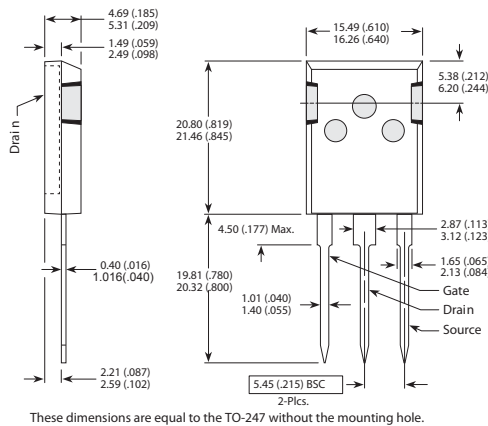

Dimensions in Millimeters (Inches)

Dimensions in Millimeters (Inches)



Стандарт Электрон Связь

Мы молодая и активно развивающаяся компания в области поставок электронных компонентов. Мы поставляем электронные компоненты отечественного и импортного производства напрямую от производителей и с крупнейших складов мира.

Благодаря сотрудничеству с мировыми поставщиками мы осуществляем комплексные и плановые поставки широчайшего спектра электронных компонентов.

Собственная эффективная логистика и склад в обеспечивает надежную поставку продукции в точно указанные сроки по всей России.

Мы осуществляем техническую поддержку нашим клиентам и предпродажную проверку качества продукции. На все поставляемые продукты мы предоставляем гарантию .

Осуществляем поставки продукции под контролем ВП МО РФ на предприятия военно-промышленного комплекса России , а также работаем в рамках 275 ФЗ с открытием отдельных счетов в уполномоченном банке. Система менеджмента качества компании соответствует требованиям ГОСТ ISO 9001.

Минимальные сроки поставки, гибкие цены, неограниченный ассортимент и индивидуальный подход к клиентам являются основой для выстраивания долгосрочного и эффективного сотрудничества с предприятиями радиоэлектронной промышленности, предприятиями ВПК и научно-исследовательскими институтами России.

С нами вы становитесь еще успешнее!

Наши контакты:

Телефон: +7 812 627 14 35

Электронная почта: sales@st-electron.ru

Адрес: 198099, Санкт-Петербург,
Промышленная ул, дом № 19, литера Н,
помещение 100-Н Офис 331