

RSL10 SIP

Bluetooth® 5 System-in-Package (SiP)

Introduction

RSL10 System-In-Package (RSL10 SIP) is a complete solution that provides the easiest way to integrate the industry's lowest power Bluetooth low energy technology into a wireless application.

The RSL10 SIP features an on-board antenna, RSL10 radio SoC, and all necessary passive components in one package to help minimize overall system size. Already fully qualified to FCC, CE, and other regulatory standards; RSL10 SIP removes the need for additional antenna design considerations or RF certifications.

Key Features

- Fully Certified:
 - ◆ Bluetooth 5
 - ◆ QDID
 - ◆ Declaration ID
 - ◆ FCC, CE, IC, MIC, KCC
- Industry's Lowest Power:
 - ◆ Peak Rx Current = 5.6 mA (1.25 V VBAT)
 - ◆ Peak Rx Current = 3.0 mA (3 V VBAT)
 - ◆ Peak Tx Current (0 dBm) = 8.9 mA (1.25 V VBAT)
 - ◆ Peak Tx Current (0 dBm) = 4.6 mA (3 V VBAT)
- Deep Sleep Current Consumption (1.25 V VBAT):
 - ◆ Deep Sleep, IO Wake-up: 50 nA
 - ◆ Deep Sleep, 8 kB RAM Retention: 300 nA
- Current Consumption (3 V VBAT):
 - ◆ Deep Sleep, IO Wake-up: 25 nA
 - ◆ Deep Sleep, 8 kB RAM Retention: 100 nA
- EEMBC ULPMark Core Profile (3 V): 1090
- EEMBC ULPMark Core Profile (2.1 V): 1360
- Advanced Wireless:
 - ◆ Supports Bluetooth Low Energy Technology and 2.4 GHz Custom Protocols
 - ◆ Supports FOTA (Firmware Over-The-Air) Updates
 - ◆ Rx Sensitivity (Bluetooth Low Energy Mode, 1 Mbps): -93 dB
 - ◆ Transmitting Power: -17 to 0 dBm
 - ◆ Range up to 100 Meters

Other Key Features

- Arm® Cortex®-M3 Processor Clocked at up to 48 MHz
- Supply Voltage Range: 1.1 – 3.3 V
- 384 kB of Flash Memory
- 76 kB of Program Memory
- 88 kB of Data Memory



ON Semiconductor®

www.onsemi.com

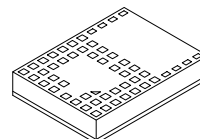

SIP51 8x6
CASE 127EY



(SIP51)

XXXXXX = Specific Device Code
A = Assembly Location
WL = Wafer Lot
Y = Year
WW = Work Week
G or ■ = Pb-Free Package

ORDERING INFORMATION

Device	Package	Shipping†
NCH-RSL10-101S51-ACG	SIP51 (Pb-Free)	2500 / Tape & Reel

†For information on tape and reel specifications, including part orientation and tape sizes, please refer to our Tape and Reel Packaging Specification Brochure, BRD8011/D.

FEATURES

- **Arm Cortex–M3 Processor:** A 32–bit core for real–time applications, specifically developed to enable high–performance low–cost platforms for a broad range of low–power applications.
- **LPDSP32:** A 32–bit Dual Harvard DSP core that efficiently supports intensive signal processing applications. Various codecs are available to customers through libraries that are included in RSL10’s development tools.
- **Radio Frequency Front–End:** Based on a 2.4 GHz RF transceiver, the RFFE implements the physical layer of the Bluetooth low energy technology standard and other proprietary or custom protocols.
- **Protocol Baseband Hardware:** Bluetooth 5 certified and includes support for a 2 Mbps RF link and custom protocol options. The RSL10 baseband stack is supplemented by support structures that enable implementation of ON Semiconductor and customer designed custom protocols.
- **Highly–Integrated SoC:** The dual–core architecture is complemented by high–efficiency power management units, oscillators, flash and RAM memories, a DMA controller, along with a full complement of peripherals and interfaces.
- **Deep Sleep Mode:** RSL10 can be put into a Deep Sleep Mode when no operations are required. Various Deep Sleep Mode configurations are available, including:
 - ◆ “IO wake–up” configuration. The power consumption in deep sleep mode is 50 nA (1.25 V VBAT).
 - ◆ Embedded 32 kHz oscillator running with interrupts from timer or external pin. The total current drain is 90 nA (1.25 V VBAT).
 - ◆ As above with 8 kB RAM data retention. The total current drain is 300 nA (1.25 V VBAT).
 - ◆ With the exception of IO wake up only configuration, the on–chip buck converter can also be enabled to reduce current consumption in Deep Sleep Mode (at higher VBAT voltages).
- **Standby Mode:** Can be used to reduce the average power consumption for off–duty cycle operation, ranging typically from a few ms to a few hundreds of ms. The typical chip power consumption is 30 μ A in Standby Mode.
- **Multi–Protocol Support:** Using the flexibility provided by LPDSP32, the Arm Cortex–M3 processor, and the RF front–end; proprietary protocols and other custom protocols are supported.
- **Flexible Supply Voltage:** RSL10 integrates high–efficiency power regulators and has a VBAT range of 1.1 to 3.3 V.
- **Highly Configurable Interfaces:** , UART, two SPI interfaces, PCM interface, multiple GPIOs. It also supports a digital microphone interface (DMIC) and an output driver (OD).
- **Flexible Clocking Scheme:** RSL10 must be clocked from the XTAL/PLL of the radio front–end at 48 MHz when transmitting or receiving RF traffic. When RSL10 is not transmitting/receiving RF traffic, it can run off the 48 MHz XTAL, the internal RC oscillators, the 32 kHz oscillator, or an external clock. A low frequency RTC clock at 32 kHz can also be used in Deep Sleep Mode. It can be sourced from either the internal XTAL, the RC oscillator, or a digital input pad.
- **Diverse Memory Architecture:** 76 kB of SRAM program memory and 88 kB of SRAM data memory are available. A total of 384 kB of flash is available to store the Bluetooth stack and other applications. The Arm Cortex–M3 processor can execute from SRAM and/or flash.
- **IP Protection Feature:** Ensures that the customer’s flash contents cannot be copied by a third party. It prevents any core or memory from being accessed externally after the chip has booted.
- **Ultra–Low Power Consumption Application Examples:**
 - ◆ Low Duty Cycle Advertising: IDD 1.1 μ A for advertising at all three channels at 5 second intervals @ VBAT 3 V, DCDC converter enabled.
- **RoHS Compliant Device**

RSL10 SIP

Notice

All specifications for the RSL10 System-in-Package are based on the RSL10 radio SoC. The RSL10 SIP data sheet only contains key parameters. For a full list of RSL10 parameters and specifications, refer to the RSL10 data sheet.

Application Board Connection

The RSL10 SIP is designed to be reflowed onto low-cost printed circuit boards. The RSL10 SIP connects to the application board via solder pads located on the bottom.

To properly operate the RSL10 SIP an external PCB connection between the RF and ANT pads is required. This connection connects the RF pin on RSL10 to the antenna

inside the SiP. If an external antenna is used instead of the antenna internal to the SiP, this external antenna needs to be connected to PIN E1.

Additionally, an external PCB connection between the VDDO and VBAT pads is required. This connection ensures that the logic high level for the digital I/O (DIO) pads is equal to VBAT.

Figures 1 and 2 show proposed layout patterns for the RSL10 SIP. The specific layout pattern used in the application may have to be adjusted to meet certain needs of the PCB manufacturer or assembly house. PCB design files for the RSL10 SIP are available at www.onsemi.com.

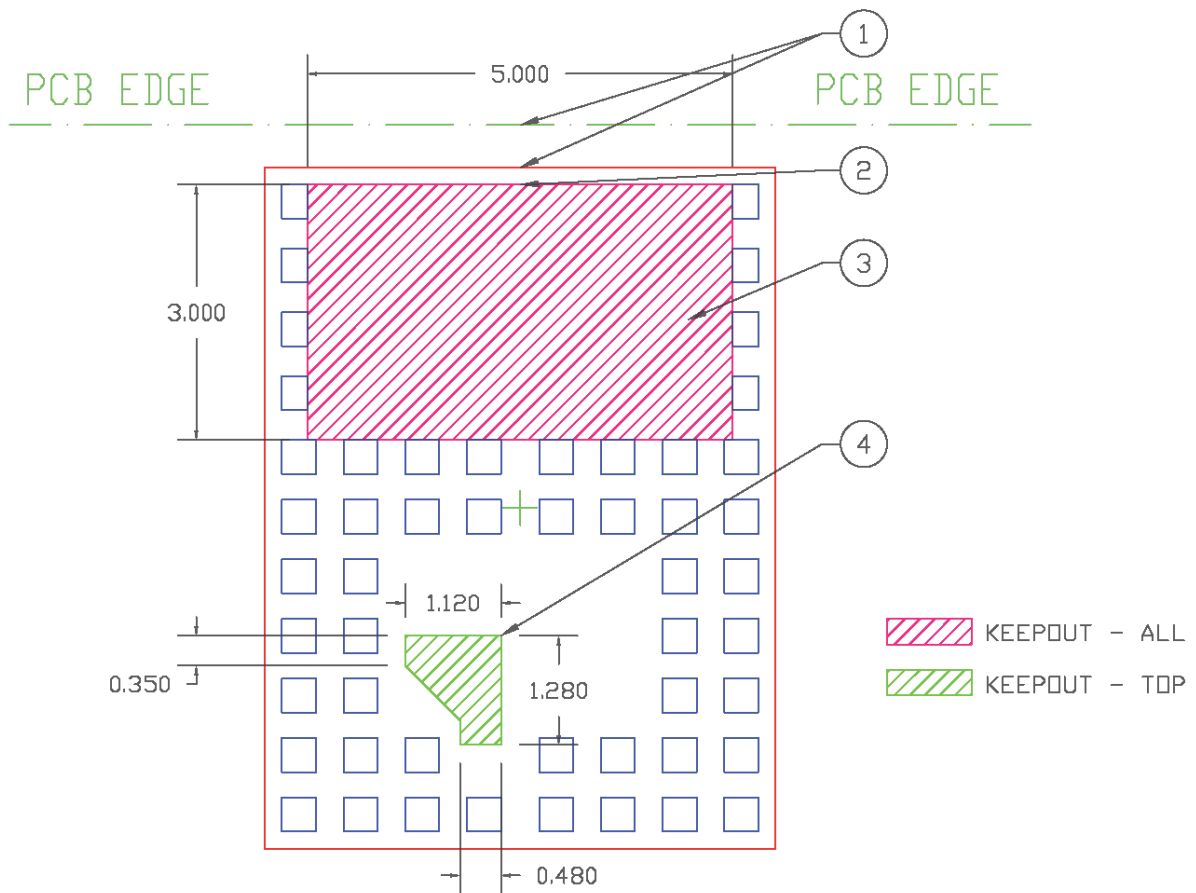

Notes:

1. Align component edge to PCB edge if possible.
2. Extend keepout area to PCB edge.
3. Keepout area- All layers.
4. Keepout area- Top layer only.
5. Units = mm.

Figure 1. RSL10 SIP Keepout Area Requirements

RSL10 SIP

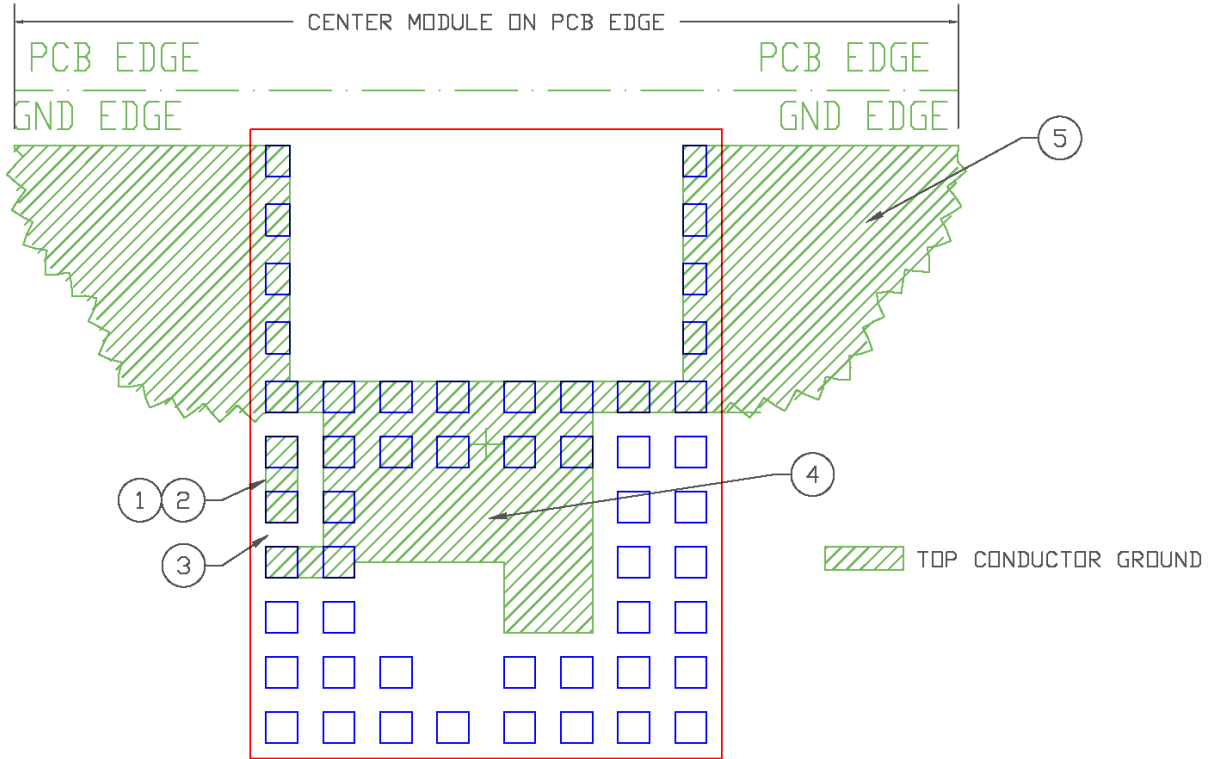

Notes:

1. When incorporating internal antenna, join landing pads using 0.40 x 1.10 shape.
2. Establish 50 Ω impedance to underlying reference plane.
3. Maintain minimum 300 μm distance from ground plane.
4. Area for several vias.
5. Refer to radiation efficiency data for applicable ground plane sizing.
6. Units = mm.

Figure 2. Minimum Top Layer Ground Structure

RSL10 SIP

RSL10 SIP Schematic

The schematic for the RSL10 SIP is shown in Figure 3.

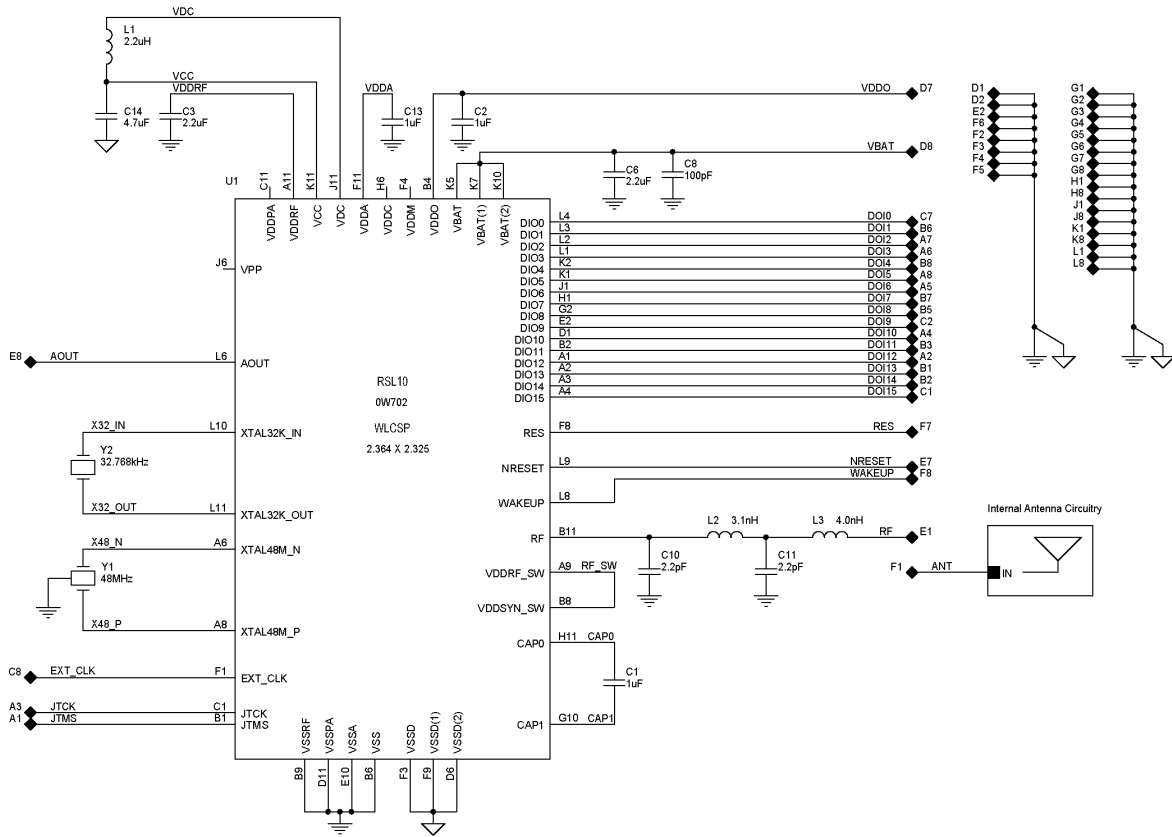

Figure 3. RSL10 SIP Schematic

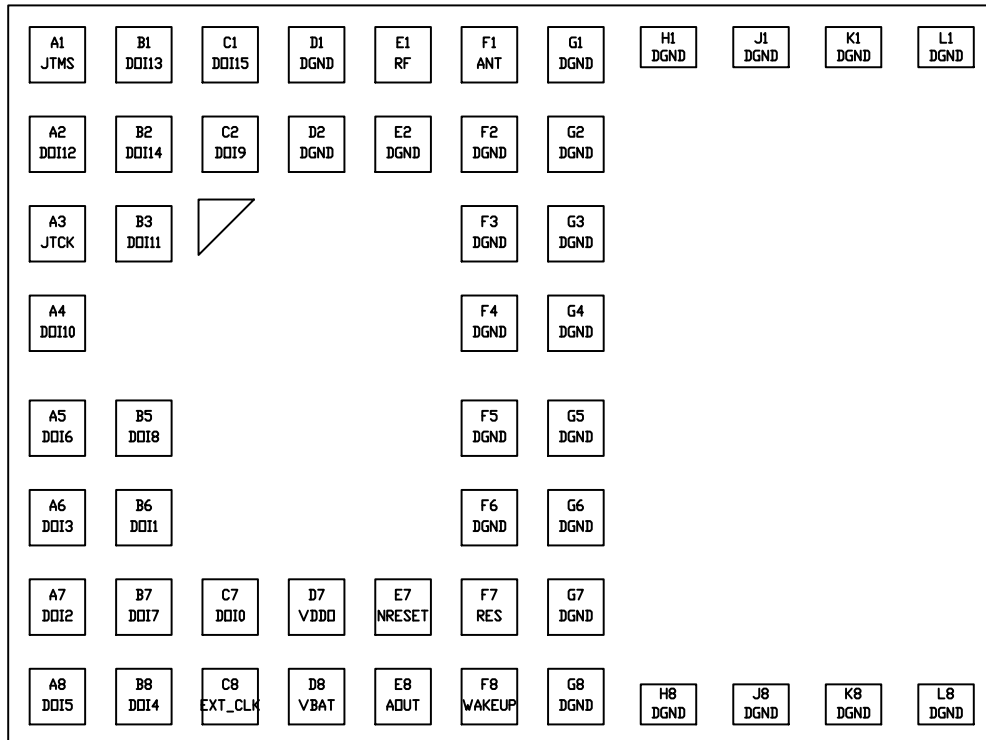

Figure 4. Pin Connection Diagram

RSL10 SIP

PAD FUNCTION DESCRIPTION

For detailed pad function information see the RSL10 data sheet.

Table 1. PAD LIST

Pad Identifier	Pad Name	I/O	A/D	Pull	Description
A1	JTMS	I/O	D	U	CM3–JTAG Test Mode State
A2	DOI12	I/O	D	U/D	Digital input output 12
A3	JTCK	I/O	D	U	CM3–JTAG Test Clock
A4	DOI10	I/O	D	U/D	Digital input output 10
A5	DOI6	I/O	D	U/D	Digital input output 6
A6	DOI3	I/O	A/D	U/D	Digital input output 3 / ADC 3
A7	DOI2	I/O	A/D	U/D	Digital input output 2 / ADC 2
A8	DOI5	I/O	D	U/D	Digital input output 5
B1	DOI13	I/O	D	U/D	Digital input output/CM3–JTAG Test Reset
B2	DOI14	I/O	D	U/D	Digital input output/CM3–JTAG Test Data In
B3	DOI11	I/O	D	U/D	Digital input output 11
B5	DOI8	I/O	D	U/D	Digital input output 8
B6	DOI1	I/O	A/D	U/D	Digital input output 1 / ADC 1
B7	DOI7	I/O	D	U/D	Digital input output 7
B8	DOI4	I/O	D	U/D	Digital input output 4
C1	DOI15	I/O	D	U/D	Digital input output/CM3–JTAG Test Data Out
C2	DOI9	I/O	D	U/D	Digital input output 9
C7	DOI0	I/O	A/D	U/D	Digital input output 0 / ADC 0
C8	EXT_CLK	I	D	U	External clock input
D1	DGND	I/O	P		Ground
D2	DGND	I/O	P		Ground
D7	VDDO	I	P		Digital O/I voltage supply
D8	VBAT	I	P		Battery input voltage
E1	RF	I/O	A		RF signal input/output
E2	DGND	I/O	P		Ground
E7	NRESET	I	D	U	Reset pin
E8	AOUT	O	A		Analog test pin
F1	ANT	I/O	A		Antenna
F2	DGND	I/O	P		Ground
F3	DGND	I/O	P		Ground
F4	DGND	I/O	P		Ground
F5	DGND	I/O	P		Ground
F6	DGND	I/O	P		Ground
F7	RES	I	D	D	RESERVED
F8	WAKEUP	I	A		Wake–up pin for power modes
G1	DGND	I/O	P		Ground
G2	DGND	I/O	P		Ground
G3	DGND	I/O	P		Ground
G4	DGND	I/O	P		Ground
G5	DGND	I/O	P		Ground

RSL10 SIP

Table 1. PAD LIST (continued)

Pad Identifier	Pad Name	I/O	A/D	Pull	Description
G6	DGND	I/O	P		Ground
G7	DGND	I/O	P		Ground
G8	DGND	I/O	P		Ground
H1	DGND	I/O	P		Ground
H8	DGND	I/O	P		Ground
J1	DGND	I/O	P		Ground
J8	DGND	I/O	P		Ground
K1	DGND	I/O	P		Ground
K8	DGND	I/O	P		Ground
L1	DGND	I/O	P		Ground
L8	DGND	I/O	P		Ground

Table 2. ABSOLUTE MAXIMUM RATINGS

Symbol	Parameter	Min	Max	Unit
VBAT	Power supply voltage	-	3.63	V
VDDO	I/O supply voltage	-	3.63	V
VSSRF	RF front-end ground	-0.3	-	V
VSSA	Analog ground	-0.3	-	V
VSSD	Digital core and I/O ground	-0.3	-	V
V _{in}	Voltage at any input pin	VSSD-0.3	VDDO+0.3	V
T functional	Functional temperature range	-40	85	°C
T storage	Storage temperature range	-40	85	°C

Caution: Class 2 ESD Sensitivity, JESD22-A114-B (2000 V)
The QFN package meets 450 V CDM level

Stresses exceeding those listed in the Maximum Ratings table may damage the device. If any of these limits are exceeded, device functionality should not be assumed, damage may occur and reliability may be affected.

Table 3. RECOMMENDED OPERATING CONDITIONS

Description	Symbol	Conditions	Min	Typ	Max	Units
Supply voltage operating range	VBAT	Input supply voltage on VBAT pin (Note 1)	1.18	1.25	3.3	V

Functional operation above the stresses listed in the Recommended Operating Ranges is not implied. Extended exposure to stresses beyond the Recommended Operating Ranges limits may affect device reliability.

1. In order to be able to use a VBAT Min of 1.1 V, the following reduced operating conditions should be observed:

- Maximum Tx power 0 dBm.
- SYSCLK ≤ 24 MHz.
- Functional temperature range limited to 0-50 deg C

The following trimming parameters should be used:

- VCC = 1.10 V
- VDDC = 0.92 V
- VDDM = 1.05 V, will be limited by VCC at end of battery life
- VDDRF = 1.05 V, will be limited by VCC at end of battery life. VDDPA should be disabled

RSL10 should enter in end-of-battery-life operating mode if VCC falls below 1.03 V. VCC will remain above 1.03 V if VBAT ≥ 1.10 V under the restricted operating conditions described above.

RSL10 SIP

Table 4. ELECTRICAL PERFORMANCE SPECIFICATIONS

Unless otherwise noted, the specifications mentioned in the table below are valid at 25°C at VBAT = VDDO = 1.25 V.

Description	Symbol	Conditions	Min	Typ	Max	Units
OVERALL						
Current consumption RX, V _{BAT} = 1.25 V, low latency	I _{VBAT}		–	1.8	–	mA
Current consumption TX, V _{BAT} = 1.25 V, low latency	I _{VBAT}		–	1.8	–	mA
Current consumption RX, V _{BAT} = 1.25 V	I _{VBAT}		–	1.15	–	mA
Deep sleep current, example 1, V _{BAT} = 1.25 V	I _{ds1}	Wake up from wake up pin.	–	50	–	nA
Deep sleep current, example 2, V _{BAT} = 1.25 V	I _{ds2}	Embedded 32 kHz oscillator running with interrupts from timer or external pin.	–	90	–	nA
Deep sleep current, example 3, V _{BAT} = 1.25 V	I _{ds3}	As I _{ds2} but with 8 kB RAM data retention.	–	300	–	nA
Standby Mode current, V _{BAT} = 1.25 V	I _{stb}	Digital blocks and memories are not clocked and are powered at a reduced voltage.	–	30	–	μA
Current consumption RX, V _{BAT} = 3 V	I _{VBAT}		–	0.9	–	mA
Current consumption TX, V _{BAT} = 3 V	I _{VBAT}		–	0.9	–	mA
Deep sleep current, example 1, V _{BAT} = 3 V	I _{ds1}	Wake up from wake up pin.	–	25	–	nA
Deep sleep current, example 2, V _{BAT} = 3 V	I _{ds2}	Embedded 32 kHz oscillator running with interrupts from timer or external pin.	–	40	–	nA
Deep sleep current, example 3, V _{BAT} = 3 V	I _{ds3}	As I _{ds2} but with 8 kB RAM data retention.	–	100	–	nA
Standby Mode current, V _{BAT} = 3 V	I _{stb}	Digital blocks and memories are not clocked and are powered at a reduced voltage.	–	17	–	μA

EEMBC ULPMark BENCHMARK, CORE PROFILE

ULPMark CP 3.0 V		Arm Cortex–M3 processor running from RAM, V _{BAT} = 3.0 V, IAR C/C++ Compiler for ARM 8.20.1.14183	–	1090	–	ULP Mark
ULPMark CP 2.1 V		Arm Cortex–M3 processor running from RAM, V _{BAT} = 2.1 V, IAR C/C++ Compiler for ARM 8.20.1.14183	–	1260	–	ULP Mark

EEMBC CoreMark BENCHMARK for the Arm Cortex–M3 Processor and the LPDSP32 DSP

Arm Cortex–M3 processor running from RAM		At 48 MHz SYSCLK. Using the IAR 8.10.1 C compiler, certified	–	159	–	Core Mark
LPDSP32 running from RAM		At 48 MHz SYSCLK Using the 2017.03–SP3–2 release of the Synopsys LPDSP32 C compiler	–	133	–	Core Mark
Arm Cortex–M3 processor and LPDSP32 running from RAM, V _{BAT} = 1.25 V		At 48 MHz SYSCLK	–	108	–	Core Mark/ mA
Arm Cortex–M3 processor and LPDSP32 running from RAM, V _{BAT} = 3 V		At 48 MHz SYSCLK	–	257	–	Core Mark/ mA

INTERNALLY GENERATED VDDC: Digital Block Supply Voltage

Supply voltage: operating range	VDDC		0.92	1.15	1.32 (Note 2)	V
Supply voltage: trimming range	VDDC _{RANGE}		0.75	–	1.38	V

RSL10 SIP

Table 4. ELECTRICAL PERFORMANCE SPECIFICATIONS (continued)

Unless otherwise noted, the specifications mentioned in the table below are valid at 25°C at VBAT = VDDO = 1.25 V.

Description	Symbol	Conditions	Min	Typ	Max	Units
INTERNALLY GENERATED VDDC: Digital Block Supply Voltage						
Supply voltage: trimming step	VDDC _{STEP}		–	10	–	mV
INTERNALLY GENERATED VDDM: Memories Supply Voltage						
Supply voltage: operating range	VDDM		1.05	1.15	1.32 (Note 3)	V
Supply voltage: trimming range	VDDM _{RANGE}		0.75	–	1.38	V
Supply voltage: trimming step	VDDM _{STEP}		–	10	–	mV
INTERNALLY GENERATED VDDRF: Radio Front end supply voltage						
Supply voltage: operating range	VDDRF		1.00	1.10	1.32 (Notes 4 and 5)	V
Supply voltage: trimming range	VDDRF _{RANGE}		0.75	–	1.38	V
Supply voltage: trimming step	VDDRF _{STEP}		–	10	–	mV
VDDO PAD SUPPLY VOLTAGE: Digital Level High Voltage						
Digital I/O supply	VDDO		1.1	1.25	3.3	V
INDUCTIVE BUCK DC-DC CONVERTER						
VBAT range when the DC-DC converter is active (Note 6)	DCDC IN_RANGE		1.4	–	3.3	V
VBAT range when the LDO is active	LDO IN_RANGE		1.1	–	3.3	V
Output voltage: trimming range	DCDC OUT_RANGE		1.1	1.2	1.32	V
Supply voltage: trimming step	DCDC _{STEP}		–	10	–	mV
POWER-ON RESET						
POR voltage	VBAT _{POR}		0.4	0.8	1.0	V
RADIO FRONT-END: General Specifications						
RF input impedance	Z _{in}	Single ended	–	50	–	Ω
Data rate FSK / MSK / GFSK	R _{FSK}	OQPSK as MSK	62.5	1000	3000	kbps
Data rate 4-FSK			–	–	4000	kbps
On-air data rate	bps	GFSK	250	–	2000	kbps
RADIO FRONT-END: Crystal and Clock Specifications						
Xtal frequency	F _{XTAL}	Fundamental	48			MHz
Settling time			–	0.5	1.5	ms
RADIO FRONT-END: Synthesizer Specifications						
Frequency range	F _{RF}	Supported carrier frequencies	2360	–	2500	MHz
RX frequency step		RX Mode frequency synthesizer resolution	–	–	100	Hz
TX frequency step		TX Mode frequency synthesizer resolution	–	–	600	Hz
PLL Settling time, RX	t _{PLL_RX}	RX Mode	–	15	25	μs
PLL Settling time, TX	t _{PLL_TX}	TX mode, BLE modulation	–	5	10	μs
RADIO FRONT-END: Receive Mode Specifications						
Current consumption at 1 Mbps, V _{BAT} = 1.25 V	IBAT _{RFRX}	VDDRF = 1.1 V, 100% duty cycle	–	5.6	–	mA

RSL10 SIP

Table 4. ELECTRICAL PERFORMANCE SPECIFICATIONS (continued)

Unless otherwise noted, the specifications mentioned in the table below are valid at 25°C at VBAT = VDDO = 1.25 V.

Description	Symbol	Conditions	Min	Typ	Max	Units
RADIO FRONT-END: Receive Mode Specifications						
Current consumption at 2 Mbps, VBAT = 1.25 V	IBAT _{RFRX}	VDDRF = 1.1 V, 100% duty cycle	–	6.2	–	mA
Current consumption at 1 Mbps, VBAT = 3 V, DC-DC	IBAT _{RFRX}	VDDRF = 1.1 V, 100% duty cycle	–	3.0	–	mA
Current consumption at 2 Mbps, VBAT = 3 V, DC-DC	IBAT _{RFRX}	VDDRF = 1.1 V, 100% duty cycle	–	3.4	–	mA
RX Sensitivity, 0.25 Mbps		0.1% BER (Notes 7, 8)	–	–96	–	dBm
RX Sensitivity, 0.5 Mbps		0.1% BER (Notes 7, 8)	–	–95	–	dBm
RX Sensitivity, 1 Mbps, BLE		0.1% BER (Notes 7, 8) Single-ended match to 50 Ω	–	–93	–	dBm
RX Sensitivity, 2 Mbps, BLE		0.1% BER (Notes 7, 8)	–	–91	–	dBm
RSSI effective range		Without AGC	–	60	–	dB
RSSI step size			–	2.4	–	dB
RX AGC range			–	48	–	dB
RX AGC step size		Programmable	–	6	–	dB
Max usable signal level		0.1% BER	–	–10	–	dBm

RADIO FRONT-END: Transmit Mode Specifications

Tx peak power consumption at VBAT = 1.25 V (Note 9)	IBAT _{RFTX}	Tx power 0 dBm, VDDRF = 1.07 V, VDDPA: off, LDO mode	–	8.9	–	mA
Tx peak power consumption at VBAT = 3 V (Note 9)	IBAT _{RFTX}	Tx power 0 dBm, VDDRF = 1.07 V, VDDPA: off, DC-DC mode	–	4.6	–	mA
Transmit power range		BLE or 802.15.4 OQPSK	–17	–	0	dBm
Transmit power step size		Full band.	–	2	–	dB
		Tx power 0 dBm. Full band. Relative to the typical value.	–1.5	–	1.5	dB
Power in 2 nd harmonic		0 dBm mode. 50 Ω for “Typ” value. (Note 10)	–	–62	–	dBm
Power in 3 rd harmonic		0 dBm mode. 50 Ω for “Typ” value. (Note 10)	–	–70	–	dBm
Power in 4 th harmonic		0 dBm mode. 50 Ω for “Typ” value. (Note 10)	–	–82	–	dBm

ADC

Resolution	ADC _{RES}		8	12	14	bits
Input voltage range	ADC _{RANGE}		0	–	2	V
INL	ADC _{INL}		–2	–	+2	mV
DNL	ADC _{DNL}		–1	–	+1	mV
Channel sampling frequency	ADC _{CH_SF}	For the 8 channels sequentially, SLOWCLK = 1 MHz	0.0195	–	6.25	kHz

32 kHz ON-CHIP RC OSCILLATOR

Untrimmed Frequency	Freq _{UNTR}		20	32	50	kHz
Trimming steps	Steps		–	1.5	–	%

3 MHz ON-CHIP RC OSCILLATOR

Untrimmed Frequency	Freq _{UNTR}		2	3	5	MHz
Trimming steps	Steps		–	1.5	–	%

RSL10 SIP

Table 4. ELECTRICAL PERFORMANCE SPECIFICATIONS (continued)

Unless otherwise noted, the specifications mentioned in the table below are valid at 25°C at VBAT = VDDO = 1.25 V.

Description	Symbol	Conditions	Min	Typ	Max	Units
-------------	--------	------------	-----	-----	-----	-------

3 MHz ON-CHIP RC OSCILLATOR

Hi Speed mode	F _{hi}		-	10	-	MHz
---------------	-----------------	--	---	----	---	-----

32 kHz ON-CHIP CRYSTAL OSCILLATOR

Output Frequency	Freq _{32k}	Depends on xtal parameters	-	32768	-	Hz
Startup time			-	1	3	s
Internal load trimming range		Steps of 0.4 pF	0		25.2	pF
Duty Cycle			40	50	60	%

DC CHARACTERISTICS OF THE DIGITAL PADS – With VDDO = 2.97 V – 3.3 V, nominal: 3.0 V Logic

Voltage level for high input	V _{IH}		2	-	VDDO+0.3	V
Voltage level for low input	V _{IL}		VSSD-0.3	-	0.8	V

DC CHARACTERISTICS OF THE DIGITAL PADS – With VDDO = 1.1 V – 1.32 V, nominal: 1.2 V Logic

Voltage level for high Input	V _{IH}		0.65* VDDO	-	VDDO+0.3	V
Voltage level for low input	V _{IL}		VSSD-0.3	-	0.35* VDDO	V

DIO DRIVE STRENGTH

DIO drive strength	IDIO		2	12	12	mA
--------------------	------	--	---	----	----	----

FLASH SPECIFICATIONS

Endurance of the 384 kB of flash			10000	-	-	write/erase cycles
Endurance for sections NVR1, NVR2, and NVR3 (6 kB in total)			1000	-	-	write/erase cycles
Retention			25	-	-	years

Product parametric performance is indicated in the Electrical Characteristics for the listed test conditions, unless otherwise noted. Product performance may not be indicated by the Electrical Characteristics if operated under different conditions.

- The maximum VDDC voltage cannot exceed the VBAT input voltage or the VCC output from the buck converter.
- The maximum VDDM voltage cannot exceed the VBAT input voltage or the VCC output from the buck converter.
- The maximum VDDRF voltage cannot exceed the VBAT input voltage or the VCC output from the buck converter.
- The VDDRF calibrated target is 1.07 V (TX power = 0 dBm).
- The LDO can be used to regulate down from VBAT and generate VCC. For VBAT values higher than 1.5 V, the LDO is less efficient and it is possible to save power by activating the DC-DC converter to generate VCC.
- Signal generated by RF tester.
- Single-ended match to 50 ohms, measured at pin E1 including loss of integrated Tx harmonic filter.
- All values are based on evaluation board performance, including the harmonic filter loss.
- The values shown here are including integrated RF filter.

RSL10 SIP

Table 5. VDDM TARGET TRIMMING VOLTAGE IN FUNCTION OF VDDO VOLTAGE

VDDM Voltage (V)	DIO_PAD_CFG DRIVE	Maximum VDDO Voltage (V)
1.05	1	2.7
1.05	0	3.2
1.10	0	3.3

NOTE: These are trimming targets at room/ATE temperature 25~30°C.

Table 6. VDDC TARGET TRIMMING VOLTAGE IN FUNCTION OF SYSCLK FREQUENCY

VDDC Voltage (V)	Maximum SYSCLK Frequency (MHz)	Restriction
0.92	≤ 24	The ADC will be functional in low frequency mode and between 0 and 85°C only.
1.00	≤ 24	Fully functional
1.05	48	Fully functional

NOTE: These are trimming targets at room/ATE temperature 25~30°C.

RSL10 SIP

ANTENNA SPECIFICATIONS

The antenna performance of the RSL10 SIP depends on the size of the ground plane on which it is mounted. Figure 5 shows an overview of different ground plane sizes with expected antenna return losses shown in Figure 6.

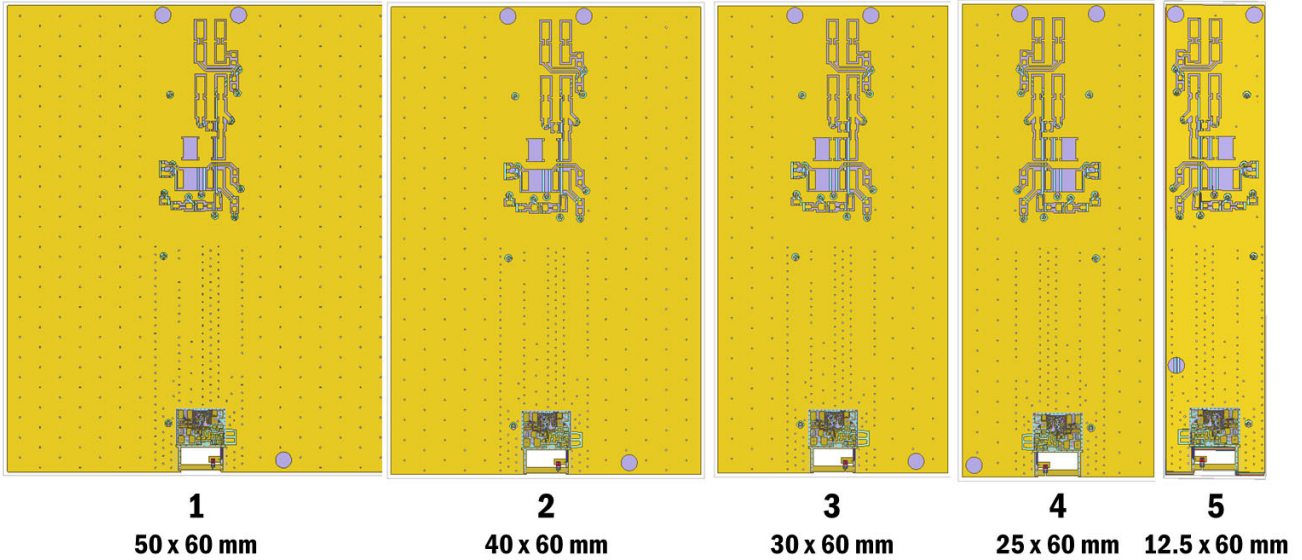

Figure 5. PCB ground planes. 1) 50x60, 2) 40x60, 3) 30x60, 4) 25x60, 5) 12.5x60. All sizes in mm

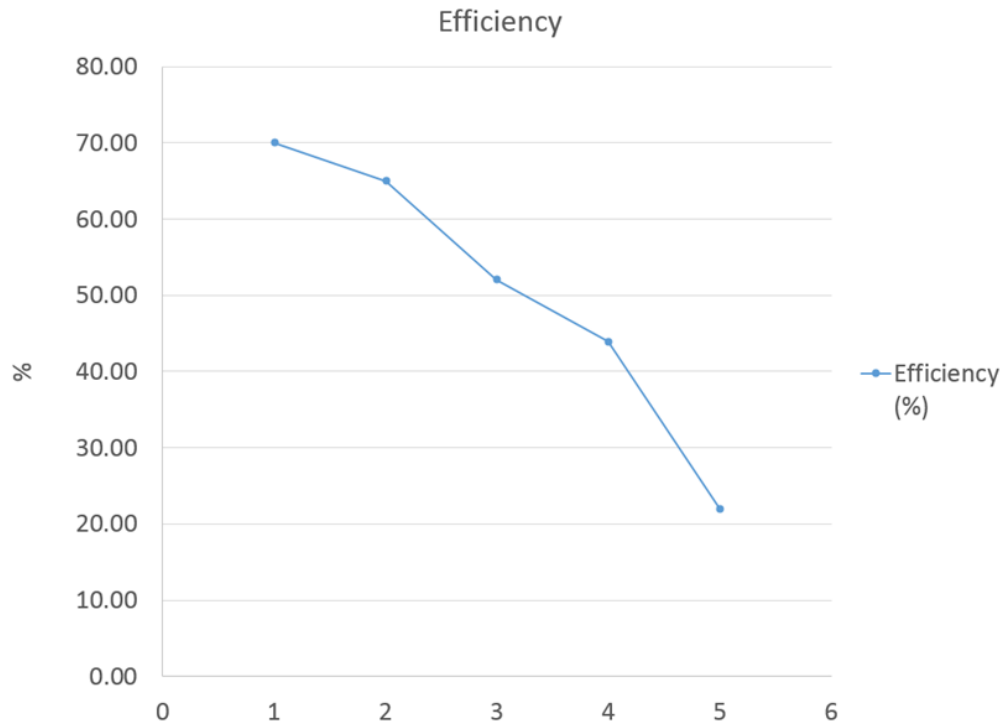

Figure 6. Antenna Efficiency vs. PCB Size

RSL10 SIP

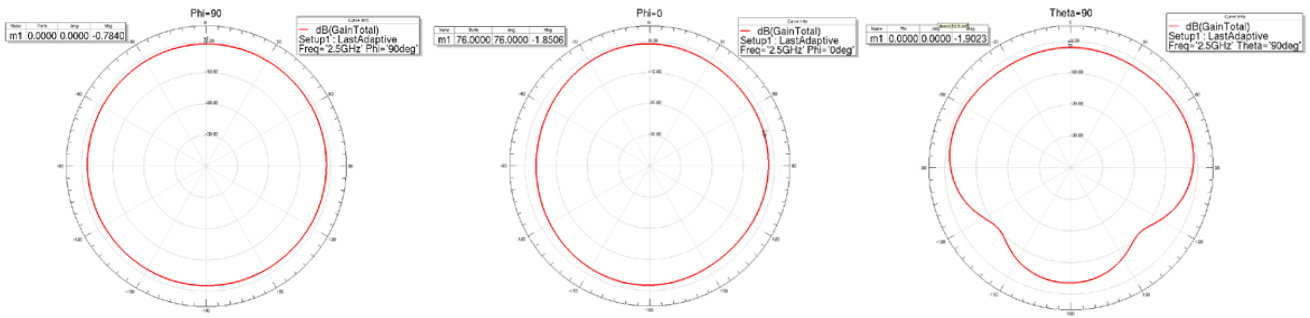

Figure 7. Radiation Pattern for PCB Ground Plane 1 (50 x 60 mm)

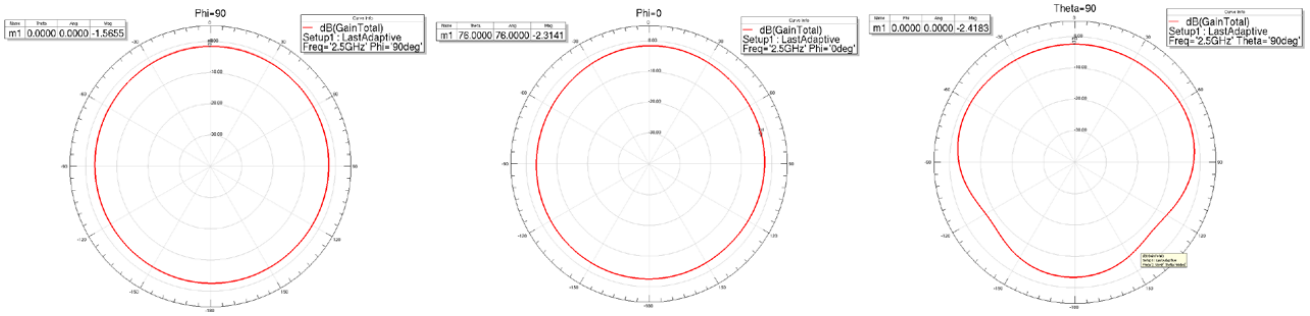

Figure 8. Radiation Pattern for PCB Ground Plane 2 (40 x 60 mm)

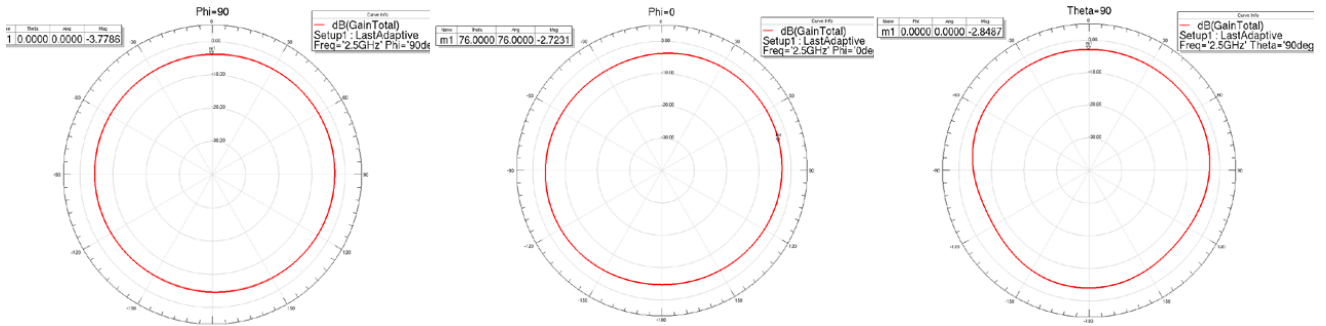

Figure 9. Radiation Pattern for PCB Ground Plane 3 (30 x 60 mm)

RSL10 SIP

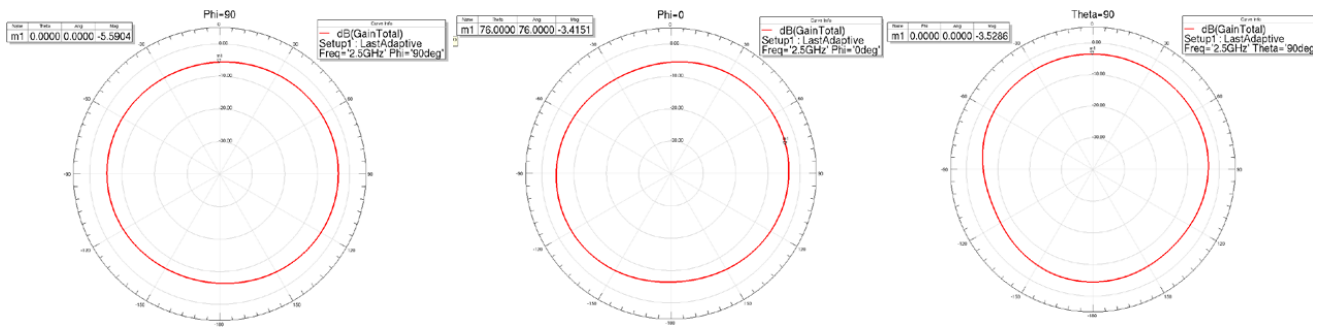

Figure 10. Radiation Pattern for PCB Ground Plane 4 (25 x 60 mm)

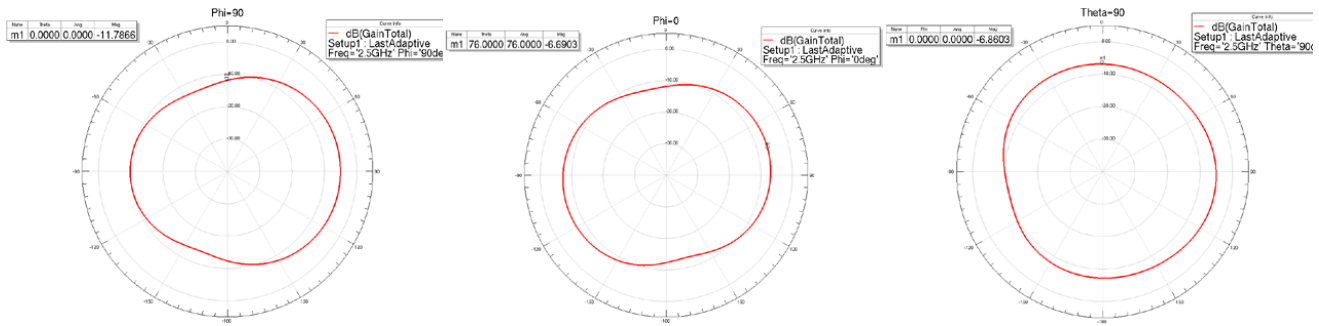

Figure 11. Radiation Pattern for PCB Ground Plane 5 (12.5 x 60 mm)

ENVIRONMENTAL SPECIFICATIONS

Electrostatic Discharge (ESD) Sensitive Device

CAUTION: ESD sensitive device. Permanent damage may occur on devices subjected to high-energy electrostatic discharges.

Proper ESD precautions in handling, packaging and testing are recommended to avoid performance degradation or loss of functionality.

Solder Information

The RSL10 SIP is constructed with all RoHS compliant material and should be reflowed accordingly. This device is Moisture Sensitive Class MSL3 and must be stored and handled accordingly. Re-flow according to IPC/JEDEC standard J-STD-020C, Joint Industry Standard: Re-flow Sensitivity Classification for Nonhermetic Solid State Surface Mount Devices. Hand soldering is not recommended for this part.

For more information, see SOLDERRM/D available from www.onsemi.com.

RSL10 SIP

REGULATORY INFORMATION

FCC Regulatory and User Information

FCC ID: 2APD9–RSL10SIP

This device complies with Part 15 of the FCC Rules. Operation is subject to the following two conditions:

(1) this device may not cause harmful interference, and (2) this device must accept any interference received, including interference that may cause undesired operation.

Any changes or modifications not expressly approved by On Semiconductor could void the user's authority to operate the equipment.

Module Usage Conditions

Manufacturers of products incorporating the RSL10SIP Bluetooth 5 Module are authorized to use the FCC Grant of the RSL10SIP module for their own products according to the conditions referenced in the grant.

A product containing the RSL10SIP module shall bear a label referring to the enclosed module. The label shall use wording such as: "Contains FCC ID:2APD9–RSL10SIP"

The label of the host device shall also contain the following statement. When this is not possible, the information shall be included in the User Manual of the host device:

"This device complies with Part 15 of the FCC Rules. Operation is subject to the following two conditions:

(1) this device may not cause harmful interference, and (2) this device must accept any interference received, including interference that may cause undesired operation.

Any changes or modifications not expressly approved by On Semiconductor could void the user's authority to operate the equipment."

WARNING: RF Exposure Compliance

In order to comply with FCC RF exposure requirements this device must be installed to provide a separation distance of 5 mm or greater between this device and the user.

ISED Regulatory and User Information

ISED ID 23763–RSL10SIP

HVIN RSL10SIP

This device contains licence–exempt transmitter(s)/receiver(s) that comply with Innovation, Science and Economic Development Canada's licence–exempt RSS(s). Operation is subject to the following two conditions:

(1) This device may not cause interference.

(2) This device must accept any interference, including interference that may cause undesired operation of the device.

L'émetteur/récepteur exempt de licence contenu dans le présent appareil est conforme aux CNR d'Innovation, Sciences et Développement économique Canada applicables aux appareils radio exempts de licence. L'exploitation est autorisée aux deux conditions suivantes: (1) L'appareil ne doit pas produire de brouillage; (2) L'appareil doit accepter tout brouillage radioélectrique subi, même si le brouillage est susceptible d'en compromettre le fonctionnement.

Module Usage Conditions

A product containing the RSL10SIP module shall bear a label referring to the enclosed module. The label shall use wording such as: "Contains IC: 23763–RSL10SIP"

The label of the host device shall also contain the following statement. When this is not possible, the information shall be included in the User Manual of the host device:

"This device contains licence–exempt transmitter(s)/receiver(s) that comply with Innovation, Science and Economic Development Canada's licence–exempt RSS(s). Operation is subject to the following two conditions:

(1) This device may not cause interference.

(2) This device must accept any interference, including interference that may cause undesired operation of the device."

The transmitter module may not be co-located with any other transmitter or antenna.

Un produit contenant le module RSL10SIP devra porter une étiquette du dispositif qui fait référence au module inclus. L'étiquette du dispositif devra utiliser un libellé tel que: "Contient IC: 23763–RSL10SIP"

L'étiquette du dispositif devra également inclure la déclaration ci-dessous. Si cela n'est pas possible, cette information devra être précisée dans le manuel de l'utilisateur:

L'émetteur/récepteur exempt de licence contenu dans le présent appareil est conforme aux CNR d'Innovation, Sciences et Développement économique Canada applicables aux appareils radio exempts de licence. L'exploitation est autorisée aux deux

RSL10 SIP

conditions suivantes: (1) L'appareil ne doit pas produire de brouillage; (2) L'appareil doit accepter tout brouillage radioélectrique subi, même si le brouillage est susceptible d'en compromettre le fonctionnement.
Le module émetteur peut ne pas être coïmplanté avec un autre émetteur ou antenne.

WARNING: RF Exposure Compliance

In order to comply with ISED RF exposure requirements this device must be installed to provide a separation distance of 7 mm or greater between this device and the user.

Afin de se conformer aux exigences d'exposition ISDE RF, cet appareil doit être installé pour fournir une distance de séparation de 7 mm ou plus entre cet appareil et l'utilisateur.

Korean Regulatory and User Information

특정소출력 무선기기(데이터통신시스템용 무선기기)

제 조 자 (제조사): ON Semiconductor

제 조 국 (원산지): 캐나다

제 품 명 (제품): NCH-RSL10-101S51-ACG

모 델 명 (모델): RSL10SIP

제조년월 (생산일자): 계류 중

이 장치는 이동전화, Wi-Fi 또는 블루투스 장치 등 무선통신장치와 매우 근접한 장소에서 사용할 경우 오작동을 일으킬 가능성이 있습니다.

해당 무선설비는 전파혼신 가능성이 있으므로 인명안전과 관련된 서비스는 할 수 없음.

The following ID information needs to be added to the product package (application and user documentation).

Korean KC Mark and Identifier as shown below. Height of KC mark is 5mm minimum. Colour preference is Navy (5PB 2/8 color according to KS A 0062). Acceptable other colours are black, gold and silver. Other colours may only be used if preferred colours are not legible for the mark. The conformity assessment certification number is to be near the KC mark. (usually below).



R-CRM-oNs-RSL10SIP

European Regulatory and User Information

This device complies with the essential requirements of the Radio Equipment Directive 2014/53/EU. The following ID information needs to be added to the product package (application and user documentation).

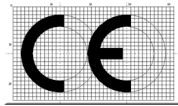

Japanese Regulatory and User Information

The following ID information needs to be added to the product package (application and user documentation).

ID (209-J00320) and must be combined with the Giteki (MIC) Mark as specified below.

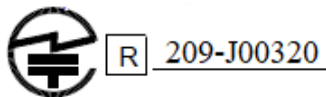

当該機器には電波法に基づく、技術基準適合証明等を受けた特定無線設備を装着している。

Translation: "This equipment contains specified radio equipment that has been certified to the Technical Regulation Conformity Certification under the Radio Law."

RSL10 SIP

Development Tools

RSL10 is supported by a full suite of comprehensive tools including:

- An easy-to-use development board
- Software Development Kit (SDK) including an Oxygen Eclipse-based development environment, Bluetooth protocol stacks, sample code, libraries, and documentation

Company or Product Inquiries

For more information about ON Semiconductor products or services visit our Web site at www.onsemi.com.

For sales or technical support, contact your local representative or authorized distributor.

RSL10 SIP

PACKAGE DIMENSIONS

SIP51 8x6
CASE 127EY
ISSUE A

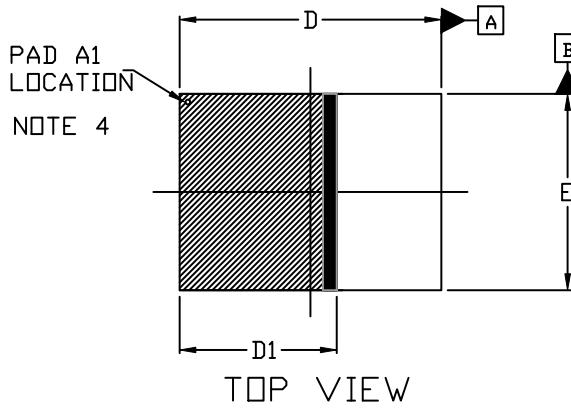

NOTES:

1. DIMENSIONING AND TOLERANCING PER ASME Y14.5M, 1994.
2. CONTROLLING DIMENSION: MILLIMETERS
3. DIMENSION b APPLIES TO PLATED TERMINAL AND IS MEASURED BETWEEN 0.15 AND 0.30 MM FROM THE TERMINAL TIP.
4. PIN 1 IDENTIFIER IS LOCATED HERE MAY APPEAR AS A CHAMFER, INK MARK, METALLIZED MARK, ETC.
5. REFER TO PRODUCT DATASHEET FOR SPECIFIC KEEP-OUT AREA AND GROUND PLANE REQUIREMENTS.

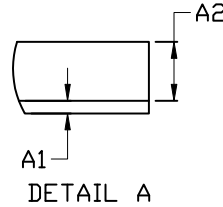
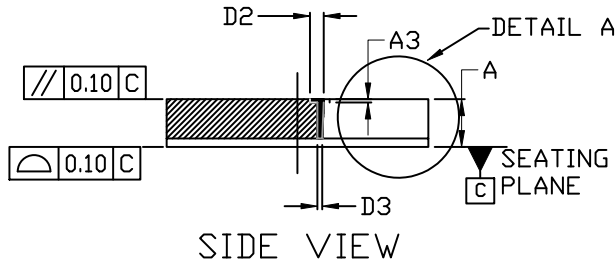

DIM	MILLIMETERS		
	MIN.	NDM.	MAX.
A	1.36	1.46	1.56
A1	0.23	0.26	0.29
A2	1.13	1.20	1.27
A3	0.10 REF		
b	0.35	0.40	0.45
b1	0.225	0.275	0.325
D	7.90	8.00	8.10
D1	4.805 REF		
D2	0.42 REF		
D3	0.15 REF		
E	5.90	6.00	6.10
e	0.70 BSC		
e1	0.75 BSC		
e2	0.725 BSC		
e3	0.85 BSC		
e4	0.60 REF		

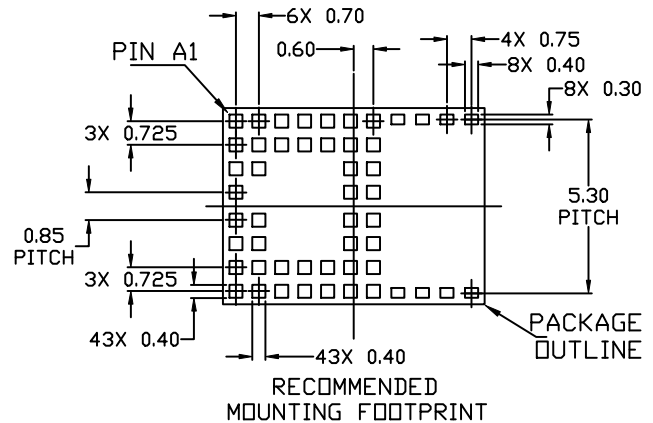
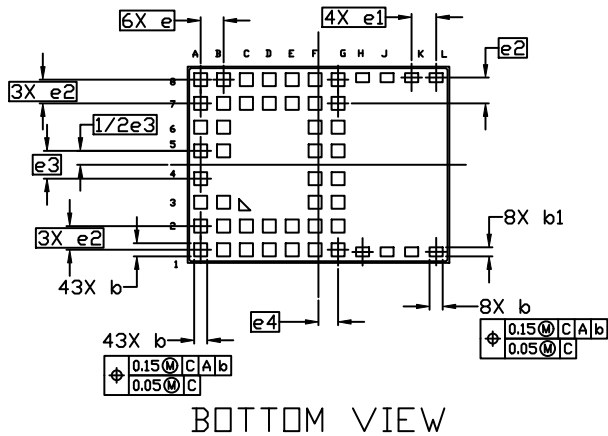

RSL10 SIP

ON Semiconductor is licensed by the Philips Corporation to carry the I²C bus protocol.

Bluetooth is a registered trademark of Bluetooth SIG.

Arm and Cortex are registered trademarks of Arm Limited (or its subsidiaries).

ON Semiconductor and  are trademarks of Semiconductor Components Industries, LLC dba ON Semiconductor or its subsidiaries in the United States and/or other countries. ON Semiconductor owns the rights to a number of patents, trademarks, copyrights, trade secrets, and other intellectual property. A listing of ON Semiconductor's product/patent coverage may be accessed at www.onsemi.com/site/pdf/Patent-Marking.pdf. ON Semiconductor reserves the right to make changes without further notice to any products herein. ON Semiconductor makes no warranty, representation or guarantee regarding the suitability of its products for any particular purpose, nor does ON Semiconductor assume any liability arising out of the application or use of any product or circuit, and specifically disclaims any and all liability, including without limitation special, consequential or incidental damages. Buyer is responsible for its products and applications using ON Semiconductor products, including compliance with all laws, regulations and safety requirements or standards, regardless of any support or applications information provided by ON Semiconductor. "Typical" parameters which may be provided in ON Semiconductor data sheets and/or specifications can and do vary in different applications and actual performance may vary over time. All operating parameters, including "Typicals" must be validated for each customer application by customer's technical experts. ON Semiconductor does not convey any license under its patent rights nor the rights of others. ON Semiconductor products are not designed, intended, or authorized for use as a critical component in life support systems or any FDA Class 3 medical devices or medical devices with a same or similar classification in a foreign jurisdiction or any devices intended for implantation in the human body. Should Buyer purchase or use ON Semiconductor products for any such unintended or unauthorized application, Buyer shall indemnify and hold ON Semiconductor and its officers, employees, subsidiaries, affiliates, and distributors harmless against all claims, costs, damages, and expenses, and reasonable attorney fees arising out of, directly or indirectly, any claim of personal injury or death associated with such unintended or unauthorized use, even if such claim alleges that ON Semiconductor was negligent regarding the design or manufacture of the part. ON Semiconductor is an Equal Opportunity/Affirmative Action Employer. This literature is subject to all applicable copyright laws and is not for resale in any manner.

PUBLICATION ORDERING INFORMATION

LITERATURE FULFILLMENT:

Literature Distribution Center for ON Semiconductor
19521 E. 32nd Pkwy, Aurora, Colorado 80011 USA
Phone: 303-675-2175 or 800-344-3860 Toll Free USA/Canada
Fax: 303-675-2176 or 800-344-3867 Toll Free USA/Canada
Email: orderlit@onsemi.com

N. American Technical Support: 800-282-9855 Toll Free
USA/Canada
Europe, Middle East and Africa Technical Support:
Phone: 421 33 790 2910

ON Semiconductor Website: www.onsemi.com

Order Literature: <http://www.onsemi.com/orderlit>

For additional information, please contact your local Sales Representative



Стандарт Электрон Связь

Мы молодая и активно развивающаяся компания в области поставок электронных компонентов. Мы поставляем электронные компоненты отечественного и импортного производства напрямую от производителей и с крупнейших складов мира.

Благодаря сотрудничеству с мировыми поставщиками мы осуществляем комплексные и плановые поставки широчайшего спектра электронных компонентов.

Собственная эффективная логистика и склад в обеспечивает надежную поставку продукции в точно указанные сроки по всей России.

Мы осуществляем техническую поддержку нашим клиентам и предпродажную проверку качества продукции. На все поставляемые продукты мы предоставляем гарантию .

Осуществляем поставки продукции под контролем ВП МО РФ на предприятия военно-промышленного комплекса России , а также работаем в рамках 275 ФЗ с открытием отдельных счетов в уполномоченном банке. Система менеджмента качества компании соответствует требованиям ГОСТ ISO 9001.

Минимальные сроки поставки, гибкие цены, неограниченный ассортимент и индивидуальный подход к клиентам являются основой для выстраивания долгосрочного и эффективного сотрудничества с предприятиями радиоэлектронной промышленности, предприятиями ВПК и научно-исследовательскими институтами России.

С нами вы становитесь еще успешнее!

Наши контакты:

Телефон: +7 812 627 14 35

Электронная почта: sales@st-electron.ru

Адрес: 198099, Санкт-Петербург,
Промышленная ул, дом № 19, литера Н,
помещение 100-Н Офис 331