

### Related products

- See TSV631, TSV632, TSV634 series for lower minimum supply voltage (1.5 V)
- See LMV821, LMV822, LMV824 series for higher gain bandwidth products (5.5 MHz)

### Applications

- Battery powered applications
- Portable devices
- Automotive signal conditioning
- Active filtering
- Medical instrumentation

### Description

The TSV52x and TSV52xA series of operational amplifiers offer low voltage operation and rail-to-rail input and output. The TSV521 device is the single version, the TSV522 device the dual version, and the TSV524 device the quad version, with pinouts compatible with industry standards.

The TSV52x and TSV52xA series offer an outstanding speed/power consumption ratio, 1.15 MHz gain bandwidth product while consuming only 45  $\mu$ A at 5 V. The devices are housed in the smallest industrial packages.

These features make the TSV52x, TSV52xA family ideal for sensor interfaces, battery supplied and portable applications. The wide temperature range and high ESD tolerance facilitate their use in harsh automotive applications.

### Features

- Gain bandwidth product: 1.15 MHz typ. at 5 V
- Low power consumption: 45  $\mu$ A typ. at 5 V
- Rail-to-rail input and output
- Low input bias current: 1 pA typ.
- Supply voltage: 2.7 to 5.5 V
- Low offset voltage: 800  $\mu$ V max.
- Unity gain stable on 100 pF capacitor
- Automotive grade

### Benefits

- Increased lifetime in battery powered applications
- Easy interfacing with high impedance sensors

**Table 1. Device summary**

|        | Standard $V_{IO}$ | Enhanced $V_{IO}$ |
|--------|-------------------|-------------------|
| Single | TSV521            | TSV521A           |
| Dual   | TSV522            | TSV522A           |
| Quad   | TSV524            | TSV524A           |

# Contents

- 1      Package pin connections ..... 3**
- 2      Absolute maximum ratings and operating conditions ..... 4**
- 3      Electrical characteristics ..... 5**
- 4      Application information ..... 13**
  - 4.1    Operating voltages ..... 13
  - 4.2    Common-mode voltage range ..... 13
  - 4.3    Rail-to-rail input ..... 14
  - 4.4    Rail-to-rail output ..... 14
  - 4.5    Driving resistive and capacitive loads ..... 14
  - 4.6    Input offset voltage drift over temperature ..... 15
  - 4.7    Long term input offset voltage drift ..... 16
  - 4.8    PCB layouts ..... 17
  - 4.9    Macromodel ..... 17
- 5      Package information ..... 18**
  - 5.1    SC705 package information ..... 19
  - 5.2    DFN8 2x2 package information ..... 20
  - 5.3    MiniSO8 package information ..... 22
  - 5.4    QFN16 3x3 package information ..... 23
  - 5.5    TSSOP14 package information ..... 25
- 6      Ordering information ..... 26**
- 7      Revision history ..... 26**

# 1 Package pin connections

Figure 1. Pin connections for each package (top view)

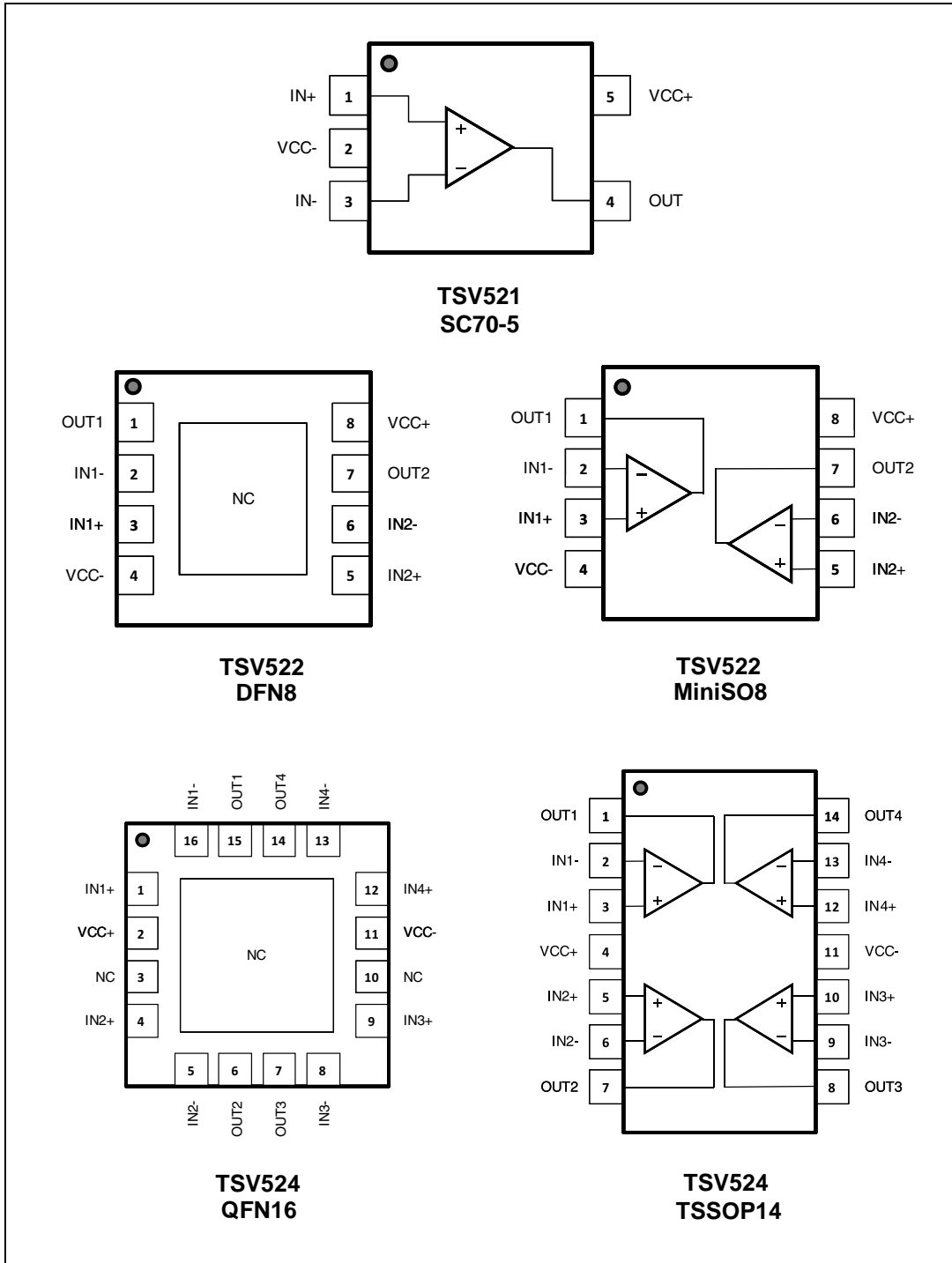

1. The exposed pads of the DFN8 (2x2) and QFN16 (3x3) can be connected to VCC- or left floating.

## 2 Absolute maximum ratings and operating conditions

**Table 2. Absolute maximum ratings (AMR)**

| Symbol     | Parameter   | Value                              | Unit |
|------------|---|------------------------------------|------|
| $V_{CC}$   | Supply voltage <sup>(1)</sup>   | 6                                  | V    |
| $V_{id}$   | Differential input voltage <sup>(2)</sup>   | $\pm V_{CC}$                       |      |
| $V_{in}$   | Input voltage <sup>(3)</sup>  | $V_{CC-} - 0.2$ to $V_{CC+} + 0.2$ |      |
| $I_{in}$   | Input current <sup>(4)</sup>  | 10                                 | mA   |
| $T_{stg}$  | Storage temperature   | -65 to +150                        | °C   |
| $R_{thja}$ | Thermal resistance junction-to-ambient <sup>(5)(6)</sup>                          |                                    | °C/W |
|            | SC70-5  | 205                                |      |
|            | DFN8 2x2  | 57                                 |      |
|            | QFN16 3x3   | 45                                 |      |
|            | MiniSO8   | 190                                |      |
|            | TSSOP14   | 100                                |      |
| $T_j$      | Maximum junction temperature  | 150                                | °C   |
| ESD        | HBM: human body model <sup>(7)</sup>  | 4                                  | kV   |
|            | MM: machine model <sup>(8)</sup>  | 300                                | V    |
|            | CDM: charged device model <sup>(9)</sup><br>(all packages except SC70-5 and DFN8) | 1.5                                | kV   |
|            | CDM: charged device model (SC70-5 and DFN8) <sup>(9)</sup>                        | 1.3                                |      |
|            | Latch-up immunity   | 200                                | mA   |

1. All voltage values, except differential voltages are with respect to network ground terminal.
2. Differential voltages are the non inverting input terminal with respect to the inverting input terminal.
3.  $V_{CC-} - V_{in}$  must not exceed 6 V,  $V_{in}$  must not exceed 6 V.
4. Input current must be limited by a resistor in series with the inputs.
5. Short-circuits can cause excessive heating and destructive dissipation.
6.  $R_{th}$  are typical values.
7. Human body model: 100 pF discharged through a 1.5 kΩ resistor between two pins of the device, done for all couples of pin combinations with other pins floating.
8. Machine model: a 200 pF cap is charged to the specified voltage, then discharged directly between two pins of the device with no external series resistor (internal resistor < 5 Ω), done for all couples of pin combinations with other pins floating.
9. Charged device model: all pins plus package are charged together to the specified voltage and then discharged directly to ground.

**Table 3. Operating conditions**

| Symbol     | Parameter                            | Value                              | Unit |
|------------|--------------------------------------|------------------------------------|------|
| $V_{CC}$   | Supply voltage                       | 2.7 to 5.5                         | V    |
| $V_{icm}$  | Common-mode input voltage range      | $V_{CC-} - 0.1$ to $V_{CC+} + 0.1$ |      |
| $T_{oper}$ | Operating free air temperature range | -40 to +125                        | °C   |

### 3 Electrical characteristics

Table 4. Electrical characteristics at  $V_{CC+} = +2.7\text{ V}$  with  $V_{CC-} = 0\text{ V}$ ,  $V_{icm} = V_{CC}/2$ ,  $T = 25\text{ }^{\circ}\text{C}$ , and  $R_L = 10\text{ k}\Omega$  connected to  $V_{CC}/2$  (unless otherwise specified)

| Symbol                   | Parameter   | Conditions  | Min. | Typ. | Max.        | Unit                           |
|--------------------------|---|---|------|------|-------------|--------------------------------|
| <b>DC performance</b>    |   |   |      |      |             |                                |
| $V_{io}$                 | Offset voltage  | TSV52xA, $T = 25\text{ }^{\circ}\text{C}$   |      |      | 800         | $\mu\text{V}$                  |
|                          |   | TSV52xA, $-40\text{ }^{\circ}\text{C} < T < 125\text{ }^{\circ}\text{C}$                                  |      |      | 2600        |                                |
|                          |   | TSV52x, $T = 25\text{ }^{\circ}\text{C}$  |      |      | 1.5         | $\text{mV}$                    |
|                          |   | TSV52x, $-40\text{ }^{\circ}\text{C} < T < 125\text{ }^{\circ}\text{C}$                                   |      |      | 3.3         |                                |
| $\Delta V_{io}/\Delta T$ | Input offset voltage drift  | $-40\text{ }^{\circ}\text{C} < T < 125\text{ }^{\circ}\text{C}^{(1)}$                                     |      | 3    | 18          | $\mu\text{V}/^{\circ}\text{C}$ |
| $I_{io}$                 | Input offset current<br>( $V_{out} = V_{CC}/2$ )  | $T = 25\text{ }^{\circ}\text{C}$  |      | 1    | $10^{(3)}$  | $\text{pA}$                    |
|                          |   | $-40\text{ }^{\circ}\text{C} < T < 125\text{ }^{\circ}\text{C}$   |      | 1    | $100^{(3)}$ |                                |
| $I_{ib}$                 | Input bias current<br>( $V_{out} = V_{CC}/2$ )  | $T = 25\text{ }^{\circ}\text{C}$  |      | 1    | $10^{(3)}$  |                                |
|                          |   | $-40\text{ }^{\circ}\text{C} < T < 125\text{ }^{\circ}\text{C}$   |      | 1    | $100^{(3)}$ |                                |
| CMR                      | Common-mode rejection ratio $20 \log(\Delta V_{ic}/\Delta V_{io})$<br>$V_{ic} = -0.1\text{ V to } V_{CC} + 0.1\text{ V}$ ,<br>$V_{out} = V_{CC}/2$ , $R_L = 1\text{ M}\Omega$ | $T = 25\text{ }^{\circ}\text{C}$  | 50   | 72   |             | $\text{dB}$                    |
|                          |   | $-40\text{ }^{\circ}\text{C} < T < 125\text{ }^{\circ}\text{C}$   | 46   |      |             |                                |
| $A_{vd}$                 | Large signal voltage gain<br>$V_{out} = 0.5\text{ V to } (V_{CC} - 0.5\text{ V})$ ,<br>$R_L = 1\text{ M}\Omega$   | $T = 25\text{ }^{\circ}\text{C}$  | 90   | 105  |             |                                |
|                          |   | $-40\text{ }^{\circ}\text{C} < T < 125\text{ }^{\circ}\text{C}$   | 60   |      |             |                                |
| $V_{OH}$                 | High level output voltage   | $T = 25\text{ }^{\circ}\text{C}$<br>$-40\text{ }^{\circ}\text{C} < T < 125\text{ }^{\circ}\text{C}$       |      | 3    | 35<br>50    | $\text{mV}$                    |
| $V_{OL}$                 | Low level output voltage  | $T = 25\text{ }^{\circ}\text{C}$<br>$-40\text{ }^{\circ}\text{C} < T < 125\text{ }^{\circ}\text{C}$       |      | 6    | 35<br>50    |                                |
| $I_{out}$                | $I_{sink}$  | $V_{out} = V_{CC}$ , $T = 25\text{ }^{\circ}\text{C}$   | 12   | 22   |             | $\text{mA}$                    |
|                          |   | $V_{out} = V_{CC}$ , $-40\text{ }^{\circ}\text{C} < T < 125\text{ }^{\circ}\text{C}$                      | 8    |      |             |                                |
|                          | $I_{source}$  | $V_{out} = 0\text{ V}$ , $T = 25\text{ }^{\circ}\text{C}$   | 12   | 18   |             |                                |
|                          |   | $V_{out} = 0\text{ V}$ , $-40\text{ }^{\circ}\text{C} < T < 125\text{ }^{\circ}\text{C}$                  | 8    |      |             |                                |
| $I_{CC}$                 | Supply current (per channel)<br>$V_{out} = V_{CC}/2$ , $R_L > 1\text{ M}\Omega$   | $T = 25\text{ }^{\circ}\text{C}$  |      | 30   | 51          | $\mu\text{A}$                  |
|                          |   | $-40\text{ }^{\circ}\text{C} < T < 125\text{ }^{\circ}\text{C}$   |      | 30   | 51          |                                |
| <b>AC performance</b>    |   |   |      |      |             |                                |
| GBP                      | Gain bandwidth product  | $R_L = 10\text{ k}\Omega$ , $C_L = 100\text{ pF}$   | 0.62 | 1    |             | $\text{MHz}$                   |
| $F_u$                    | Unity gain frequency  |   |      | 900  |             | $\text{kHz}$                   |
| $\Phi_m$                 | Phase margin  |   |      | 55   |             | degrees                        |
| $G_m$                    | Gain margin   |   |      | 7    |             | $\text{dB}$                    |
| SR                       | Slew rate   | $R_L = 10\text{ k}\Omega$ , $C_L = 100\text{ pF}$ ,<br>$V_{out} = 0.5\text{ V to } V_{CC} - 0.5\text{ V}$ |      | 0.74 |             | $\text{V}/\mu\text{s}$         |

**Table 4. Electrical characteristics at  $V_{CC+} = +2.7\text{ V}$  with  $V_{CC-} = 0\text{ V}$ ,  $V_{icm} = V_{CC}/2$ ,  $T = 25\text{ }^{\circ}\text{C}$ , and  $R_L = 10\text{ k}\Omega$  connected to  $V_{CC}/2$  (unless otherwise specified) (continued)**

| Symbol | Parameter                         | Conditions   | Min. | Typ.     | Max. | Unit                                 |
|--------|-----------------------------------|--|------|----------|------|--------------------------------------|
| $e_n$  | Equivalent input noise voltage    | $f = 1\text{ kHz}$<br>$f = 10\text{ kHz}$  |      | 61<br>43 |      | $\frac{\text{nV}}{\sqrt{\text{Hz}}}$ |
| THD+N  | Total harmonic distortion + noise | Follower configuration, $f_{in} = 1\text{ kHz}$ ,<br>$R_L = 100\text{ k}\Omega$ , $V_{icm} = V_{CC}/2$ ,<br>$BW = 22\text{ kHz}$ , $V_{out} = 1\text{ V}_{pp}$ |      | 0.003    |      | %                                    |

**Table 5. Electrical characteristics at  $V_{CC+} = +3.3\text{ V}$  with  $V_{CC-} = 0\text{ V}$ ,  $V_{icm} = V_{CC}/2$ ,  $T = 25\text{ }^{\circ}\text{C}$ , and  $R_L = 10\text{ k}\Omega$  connected to  $V_{CC}/2$  (unless otherwise specified)**

| Symbol                   | Parameter  | Conditions  | Min. | Typ. | Max.        | Unit                                      |
|--------------------------|--|---|------|------|-------------|---|
| <b>DC performance</b>    |  |   |      |      |             |   |
| $V_{io}$                 | Offset voltage   | TSV52xA, $T = 25\text{ }^{\circ}\text{C}$   |      |      | 600         | $\mu\text{V}$                             |
|                          |  | TSV52xA, $-40\text{ }^{\circ}\text{C} < T < 125\text{ }^{\circ}\text{C}$                            |      |      | 2400        |   |
|                          |  | TSV52x, $T = 25\text{ }^{\circ}\text{C}$  |      |      | 1.3         | mV  |
|                          |  | TSV52x, $-40\text{ }^{\circ}\text{C} < T < 125\text{ }^{\circ}\text{C}$                             |      |      | 3.1         |   |
| $\Delta V_{io}/\Delta T$ | Input offset voltage drift   | $-40\text{ }^{\circ}\text{C} < T < 125\text{ }^{\circ}\text{C}^{(1)}$                               |      | 3    | 18          | $\mu\text{V}/^{\circ}\text{C}$            |
| $\Delta V_{io}$          | Long term input offset voltage drift   | $T = 25\text{ }^{\circ}\text{C}^{(2)}$  |      | 0.3  |             | $\frac{\mu\text{V}}{\sqrt{\text{month}}}$ |
| $I_{io}$                 | Input offset current ( $V_{out} = V_{CC}/2$ )  | $T = 25\text{ }^{\circ}\text{C}$  |      | 1    | $10^{(3)}$  | pA  |
|                          |  | $-40\text{ }^{\circ}\text{C} < T < 125\text{ }^{\circ}\text{C}$                                     |      | 1    | $100^{(3)}$ |   |
| $I_{ib}$                 | Input bias current ( $V_{out} = V_{CC}/2$ )  | $T = 25\text{ }^{\circ}\text{C}$  |      | 1    | $10^{(3)}$  |   |
|                          |  | $-40\text{ }^{\circ}\text{C} < T < 125\text{ }^{\circ}\text{C}$                                     |      | 1    | $100^{(3)}$ |   |
| CMR                      | Common-mode rejection ratio $20\log(\Delta V_{ic}/\Delta V_{io})$<br>$V_{ic} = -0.1\text{ V to } V_{CC} + 0.1\text{ V}$ ,<br>$V_{out} = V_{CC}/2$ , $R_L = 1\text{ M}\Omega$ | $T = 25\text{ }^{\circ}\text{C}$  | 51   | 73   |             | dB  |
|                          |  | $-40\text{ }^{\circ}\text{C} < T < 125\text{ }^{\circ}\text{C}$                                     | 47   |      |             |   |
| $A_{vd}$                 | Large signal voltage gain<br>$V_{out} = 0.5\text{ V to } (V_{CC} - 0.5\text{ V})$ ,<br>$R_L = 1\text{ M}\Omega$  | $T = 25\text{ }^{\circ}\text{C}$  | 91   | 106  |             |   |
|                          |  | $-40\text{ }^{\circ}\text{C} < T < 125\text{ }^{\circ}\text{C}$                                     | 63   |      |             |   |
| $V_{OH}$                 | High level output voltage  | $T = 25\text{ }^{\circ}\text{C}$<br>$-40\text{ }^{\circ}\text{C} < T < 125\text{ }^{\circ}\text{C}$ |      | 3    | 35<br>50    | mV  |
| $V_{OL}$                 | Low level output voltage   | $T = 25\text{ }^{\circ}\text{C}$<br>$-40\text{ }^{\circ}\text{C} < T < 125\text{ }^{\circ}\text{C}$ |      | 7    | 35<br>50    |   |
| $I_{out}$                | $I_{sink}$   | $V_{out} = V_{CC}$ , $T = 25\text{ }^{\circ}\text{C}$   | 20   | 31   |             | mA  |
|                          |  | $V_{out} = V_{CC}$ , $-40\text{ }^{\circ}\text{C} < T < 125\text{ }^{\circ}\text{C}$                | 17   |      |             |   |
|                          | $I_{source}$   | $V_{out} = 0\text{ V}$ , $T = 25\text{ }^{\circ}\text{C}$   | 19   | 27   |             |   |
|                          |  | $V_{out} = 0\text{ V}$ , $-40\text{ }^{\circ}\text{C} < T < 125\text{ }^{\circ}\text{C}$            | 17   |      |             |   |
| $I_{CC}$                 | Supply current (per channel)<br>$V_{out} = V_{CC}/2$ , $R_L > 1\text{ M}\Omega$  | $T = 25\text{ }^{\circ}\text{C}$  |      | 32   | 55          | $\mu\text{A}$                             |
|                          |  | $-40\text{ }^{\circ}\text{C} < T < 125\text{ }^{\circ}\text{C}$                                     |      | 32   | 55          |   |

**Table 5. Electrical characteristics at  $V_{CC+} = +3.3\text{ V}$  with  $V_{CC-} = 0\text{ V}$ ,  $V_{icm} = V_{CC}/2$ ,  $T = 25\text{ }^{\circ}\text{C}$ , and  $R_L = 10\text{ k}\Omega$  connected to  $V_{CC}/2$  (unless otherwise specified) (continued)**

| Symbol                | Parameter                         | Conditions   | Min. | Typ.     | Max. | Unit                                 |
|-----------------------|-----------------------------------|--|------|----------|------|--------------------------------------|
| <b>AC performance</b> |                                   |  |      |          |      |                                      |
| GBP                   | Gain bandwidth product            | $R_L = 10\text{ k}\Omega$ , $C_L = 100\text{ pF}$  | 0.64 | 1        |      | MHz                                  |
| $F_u$                 | Unity gain frequency              |  |      | 900      |      | kHz                                  |
| $\Phi_m$              | Phase margin                      |  |      | 55       |      | degrees                              |
| $G_m$                 | Gain margin                       |  |      | 7        |      | dB                                   |
| SR                    | Slew rate                         | $R_L = 10\text{ k}\Omega$ , $C_L = 100\text{ pF}$ ,<br>$V_{out} = 0.5\text{ V}$ to $V_{CC} - 0.5\text{ V}$   |      | 0.75     |      | V/ $\mu\text{s}$                     |
| $e_n$                 | Equivalent input noise voltage    | $f = 1\text{ kHz}$<br>$f = 10\text{ kHz}$  |      | 60<br>42 |      | $\frac{\text{nV}}{\sqrt{\text{Hz}}}$ |
| THD+N                 | Total harmonic distortion + noise | Follower configuration, $f_{in} = 1\text{ kHz}$ ,<br>$R_L = 100\text{ k}\Omega$ , $V_{icm} = V_{CC}/2$ ,<br>$BW = 22\text{ kHz}$ , $V_{out} = 1\text{ V}_{pp}$ |      | 0.003    |      | %                                    |

**Table 6. Electrical characteristics at  $V_{CC+} = +5\text{ V}$  with  $V_{CC-} = 0\text{ V}$ ,  $V_{icm} = V_{CC}/2$ ,  $T = 25\text{ }^{\circ}\text{C}$ , and  $R_L = 10\text{ k}\Omega$  connected to  $V_{CC}/2$  (unless otherwise specified)**

| Symbol                   | Parameter   | Conditions   | Min. | Typ. | Max.        | Unit                                      |
|--------------------------|---|--|------|------|-------------|---|
| <b>DC performance</b>    |   |  |      |      |             |   |
| $V_{io}$                 | Offset voltage  | TSV52xA, $T = 25\text{ }^{\circ}\text{C}$                                |      |      | 600         | $\mu\text{V}$                             |
|                          |   | TSV52xA, $-40\text{ }^{\circ}\text{C} < T < 125\text{ }^{\circ}\text{C}$ |      |      | 2400        |   |
|                          |   | TSV52x, $T = 25\text{ }^{\circ}\text{C}$                                 |      |      | 1           | mV  |
|                          |   | TSV52x, $-40\text{ }^{\circ}\text{C} < T < 125\text{ }^{\circ}\text{C}$  |      |      | 2.8         |   |
| $\Delta V_{io}/\Delta T$ | Input offset voltage drift  | $-40\text{ }^{\circ}\text{C} < T < 125\text{ }^{\circ}\text{C}^{(1)}$    |      | 3    | 18          | $\mu\text{V}/^{\circ}\text{C}$            |
| $\Delta V_{io}$          | Long term input offset voltage drift  | $T = 25\text{ }^{\circ}\text{C}^{(2)}$                                   |      | 0.7  |             | $\frac{\mu\text{V}}{\sqrt{\text{month}}}$ |
| $I_{io}$                 | Input offset current<br>( $V_{out} = V_{CC}/2$ )  | $T = 25\text{ }^{\circ}\text{C}$   |      | 1    | $10^{(3)}$  | pA  |
|                          |   | $-40\text{ }^{\circ}\text{C} < T < 125\text{ }^{\circ}\text{C}$          |      | 1    | $100^{(3)}$ |   |
| $I_{ib}$                 | Input bias current<br>( $V_{out} = V_{CC}/2$ )  | $T = 25\text{ }^{\circ}\text{C}$   |      | 1    | $10^{(3)}$  |   |
|                          |   | $-40\text{ }^{\circ}\text{C} < T < 125\text{ }^{\circ}\text{C}$          |      | 1    | $100^{(3)}$ |   |
| CMR1                     | Common-mode rejection ratio $20\log(\Delta V_{ic}/\Delta V_{io})$<br>$V_{ic} = -0.1\text{ V}$ to $V_{CC} + 0.1\text{ V}$ ,<br>$V_{out} = V_{CC}/2$ , $R_L = 1\text{ M}\Omega$ | $T = 25\text{ }^{\circ}\text{C}$   | 54   | 76   |             | dB  |
|                          |   | $-40\text{ }^{\circ}\text{C} < T < 125\text{ }^{\circ}\text{C}$          | 50   |      |             |   |
| CMR2                     | Common-mode rejection ratio $20\log(\Delta V_{ic}/\Delta V_{io})$<br>$V_{ic} = 1\text{ V}$ to $V_{CC} - 1\text{ V}$ ,<br>$V_{out} = V_{CC}/2$ , $R_L = 1\text{ M}\Omega$      | $T = 25\text{ }^{\circ}\text{C}$   | 63   | 84   |             |   |
|                          |   | $-40\text{ }^{\circ}\text{C} < T < 125\text{ }^{\circ}\text{C}$          | 58   |      |             |   |

**Table 6. Electrical characteristics at  $V_{CC+} = +5\text{ V}$  with  $V_{CC-} = 0\text{ V}$ ,  $V_{icm} = V_{CC}/2$ ,  $T = 25\text{ }^{\circ}\text{C}$ , and  $R_L = 10\text{ k}\Omega$  connected to  $V_{CC}/2$  (unless otherwise specified) (continued)**

| Symbol                | Parameter   | Conditions   | Min. | Typ.     | Max.     | Unit                                 |
|-----------------------|---|--|------|----------|----------|--------------------------------------|
| SVR                   | Supply voltage rejection ratio $20 \log(\Delta V_{CC}/\Delta V_{io})$<br>$V_{CC} = 2.7\text{ V to } 5.5\text{ V}$ ,<br>$V_{out} = V_{CC}/2$ | $T = 25\text{ }^{\circ}\text{C}$   | 65   | 87       |          | dB                                   |
|                       |   | $-40\text{ }^{\circ}\text{C} < T < 125\text{ }^{\circ}\text{C}$  | 60   |          |          |                                      |
| $A_{vd}$              | Large signal voltage gain<br>$V_{out} = 0.5\text{ V to } (V_{CC} - 0.5\text{ V})$ ,<br>$R_L = 1\text{ M}\Omega$                             | $T = 25\text{ }^{\circ}\text{C}$   | 94   | 109      |          |                                      |
|                       |   | $-40\text{ }^{\circ}\text{C} < T < 125\text{ }^{\circ}\text{C}$  | 68   |          |          |                                      |
| $V_{OH}$              | High level output voltage   | $T = 25\text{ }^{\circ}\text{C}$<br>$-40\text{ }^{\circ}\text{C} < T < 125\text{ }^{\circ}\text{C}$  |      | 5        | 35<br>50 | mV                                   |
| $V_{OL}$              | Low level output voltage  | $T = 25\text{ }^{\circ}\text{C}$<br>$-40\text{ }^{\circ}\text{C} < T < 125\text{ }^{\circ}\text{C}$  |      | 9        | 35<br>50 |                                      |
| $I_{out}$             | $I_{sink}$  | $V_{out} = V_{CC}$ , $T = 25\text{ }^{\circ}\text{C}$  | 36   | 55       |          | mA                                   |
|                       |   | $V_{out} = V_{CC}$ , $-40\text{ }^{\circ}\text{C} < T < 125\text{ }^{\circ}\text{C}$   | 27   |          |          |                                      |
|                       | $I_{source}$  | $V_{out} = 0\text{ V}$ , $T = 25\text{ }^{\circ}\text{C}$  | 36   | 55       |          |                                      |
|                       |   | $V_{out} = 0\text{ V}$ , $-40\text{ }^{\circ}\text{C} < T < 125\text{ }^{\circ}\text{C}$   | 27   |          |          |                                      |
| $I_{CC}$              | Supply current (per channel)<br>$V_{out} = V_{CC}/2$ , $R_L > 1\text{ M}\Omega$   | $T = 25\text{ }^{\circ}\text{C}$   |      | 45       | 60       | $\mu\text{A}$                        |
|                       |   | $-40\text{ }^{\circ}\text{C} < T < 125\text{ }^{\circ}\text{C}$  |      | 45       | 60       |                                      |
| <b>AC performance</b> |   |  |      |          |          |                                      |
| GBP                   | Gain bandwidth product  | $R_L = 10\text{ k}\Omega$ , $C_L = 100\text{ pF}$  | 0.73 | 1.15     |          | MHz                                  |
| $F_u$                 | Unity gain frequency  | $R_L = 10\text{ k}\Omega$ , $C_L = 100\text{ pF}$  |      | 900      |          | kHz                                  |
| $\Phi_m$              | Phase margin  | $R_L = 10\text{ k}\Omega$ , $C_L = 100\text{ pF}$  |      | 55       |          | degrees                              |
| $G_m$                 | Gain margin   | $R_L = 10\text{ k}\Omega$ , $C_L = 100\text{ pF}$  |      | 7        |          | dB                                   |
| SR                    | Slew rate   | $R_L = 10\text{ k}\Omega$ , $C_L = 100\text{ pF}$ ,<br>$V_{out} = 0.5\text{ V to } V_{CC} - 0.5\text{ V}$  |      | 0.89     |          | $\text{V}/\mu\text{s}$               |
| $\int e_n$            | Low-frequency peak-to-peak input noise  | Bandwidth: $f = 0.1\text{ to } 10\text{ Hz}$   |      | 14       |          | $\mu\text{V}_{pp}$                   |
| $e_n$                 | Equivalent input noise voltage  | $f = 1\text{ kHz}$<br>$f = 10\text{ kHz}$  |      | 57<br>39 |          | $\frac{\text{nV}}{\sqrt{\text{Hz}}}$ |
| THD+N                 | Total harmonic distortion + noise   | Follower configuration, $f_{in} = 1\text{ kHz}$ ,<br>$R_L = 100\text{ k}\Omega$ , $V_{icm} = V_{CC}/2$ ,<br>$BW = 22\text{ kHz}$ , $V_{out} = 1\text{ V}_{pp}$ |      | 0.002    |          | %                                    |

1. See [Section 4.6: Input offset voltage drift over temperature](#).
2. Typical value is based on the  $V_{io}$  drift observed after 1000 h at  $125\text{ }^{\circ}\text{C}$  extrapolated to  $25\text{ }^{\circ}\text{C}$  using the Arrhenius law and assuming an activation energy of  $0.7\text{ eV}$ . The operational amplifier is aged in follower mode configuration.
3. Guaranteed by design.



Figure 2. Supply current vs. supply voltage at  $V_{icm} = V_{CC}/2$



Figure 3. Input offset voltage distribution at  $V_{CC} = 5 V, V_{icm} = 2.5 V$



Figure 4. Input offset voltage temperature coefficient distribution



Figure 5. Input offset voltage vs. input Common-mode voltage at  $V_{CC} = 5 V$



Figure 6. Input offset voltage vs. temperature at  $V_{CC} = 5 V$



Figure 7. Output current vs. output voltage at  $V_{CC} = 2.7 V$



Figure 8. Output current vs. output voltage at  $V_{CC} = 5.5\text{ V}$

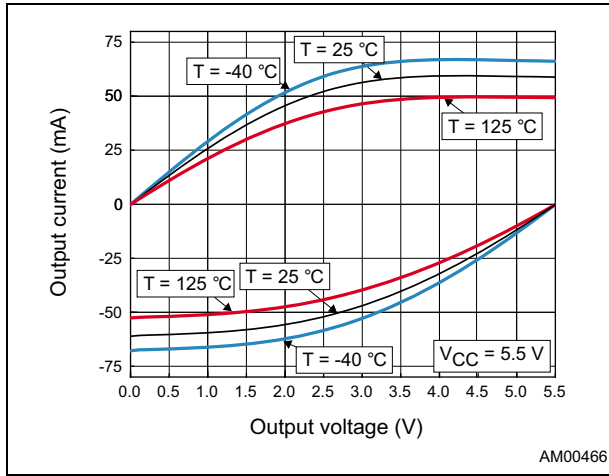

Figure 9. Bode diagram at  $V_{CC} = 2.7\text{ V}$ ,  $R_L = 10\text{ k}\Omega$

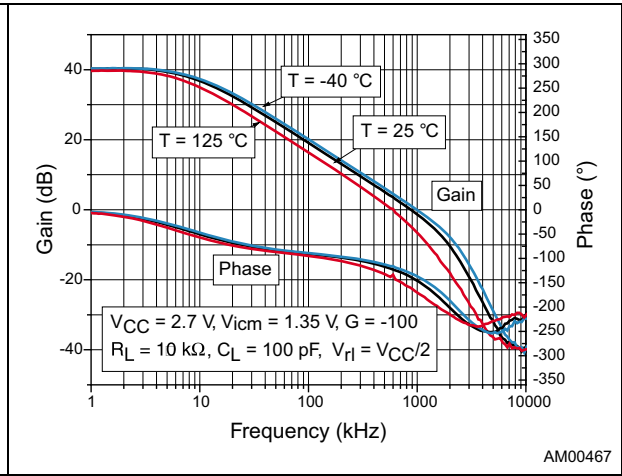

Figure 10. Bode diagram at  $V_{CC} = 2.7\text{ V}$ ,  $R_L = 2\text{ k}\Omega$

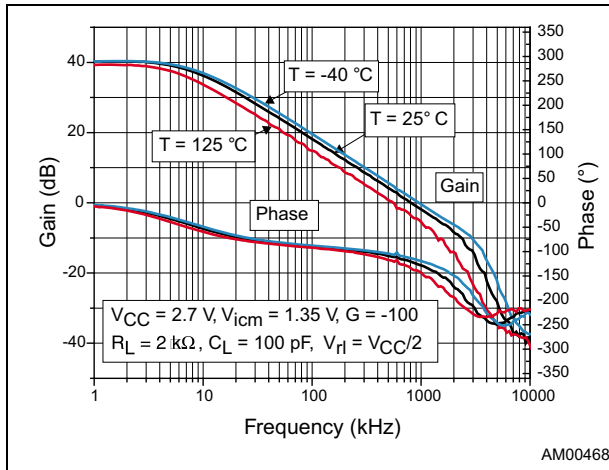

Figure 11. Bode diagram at  $V_{CC} = 5.5\text{ V}$ ,  $R_L = 10\text{ k}\Omega$

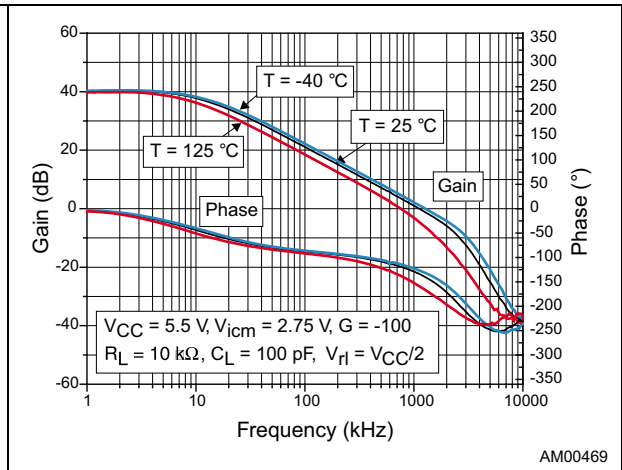

Figure 12. Bode diagram at  $V_{CC} = 5.5\text{ V}$ ,  $R_L = 2\text{ k}\Omega$

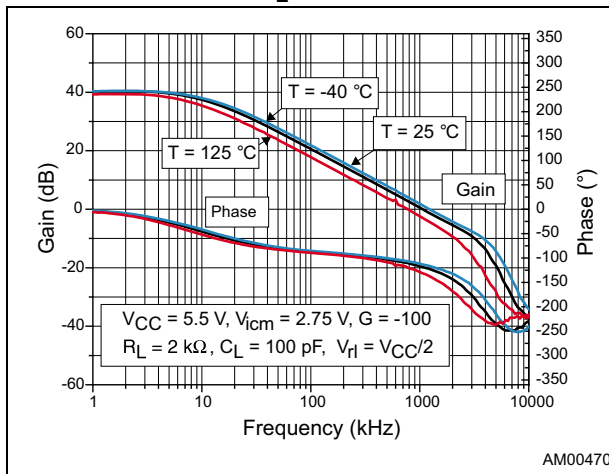

Figure 13. Noise vs. frequency

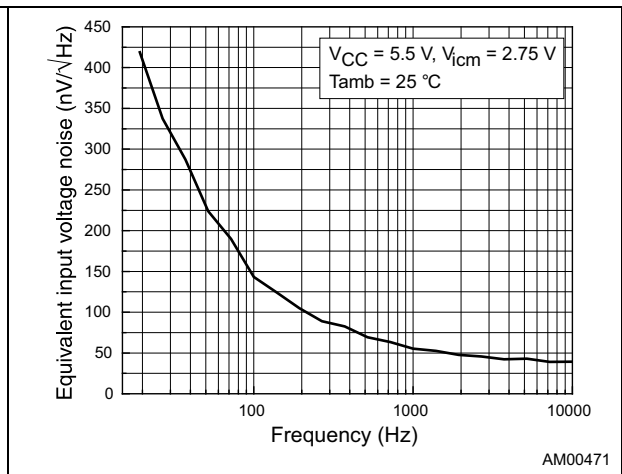

Figure 14. Positive slew rate vs. supply voltage Figure 15. Negative slew rate vs. supply voltage



Figure 16. THD+N vs. frequency at VCC = 2.7 V



Figure 17. THD+N vs. frequency at VCC = 5.5 V



Figure 18. THD+N vs. output voltage at VCC = 2.7 V



Figure 19. THD+N vs. output voltage at VCC = 5.5 V



Figure 20. Output impedance versus frequency in closed-loop configuration

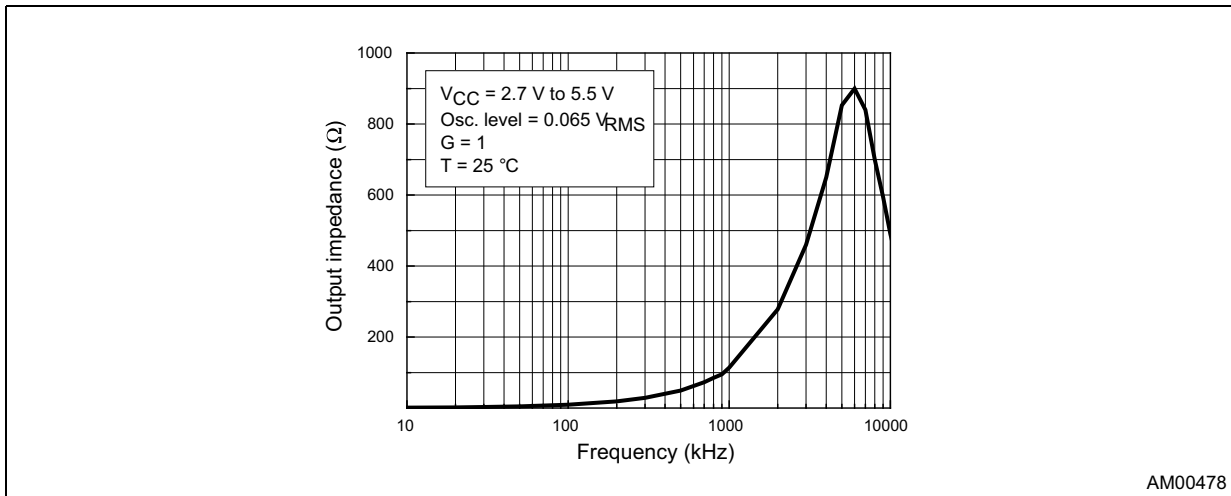

Figure 21. Response to a 100 mV input step for gain = 1 at  $V_{CC} = 5.5 \text{ V}$  rising edge

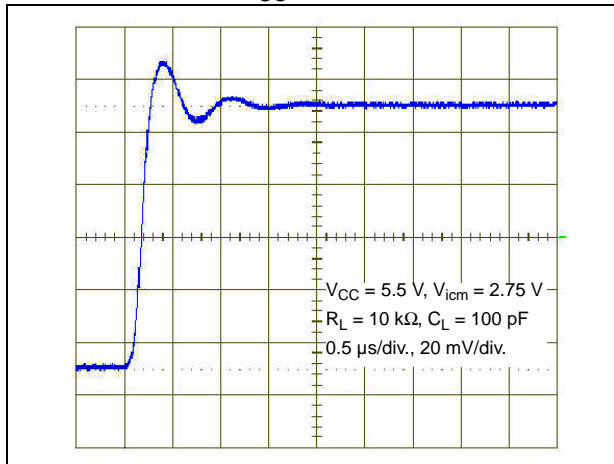

Figure 22. Response to a 100 mV input step for gain = 1 at  $V_{CC} = 5.5 \text{ V}$  falling edge

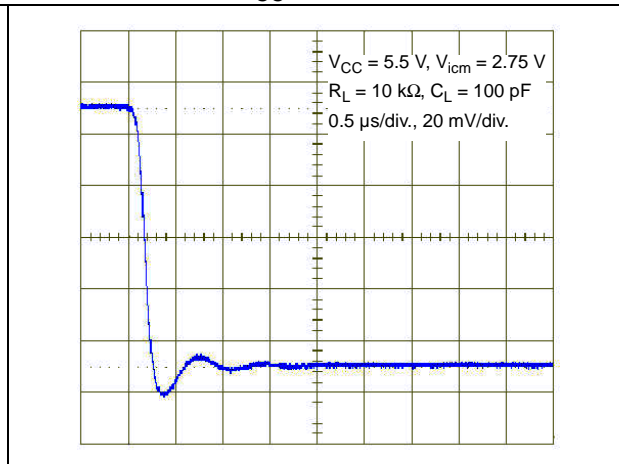

Figure 23. PSRR vs. frequency at  $V_{CC} = 2.7 \text{ V}$

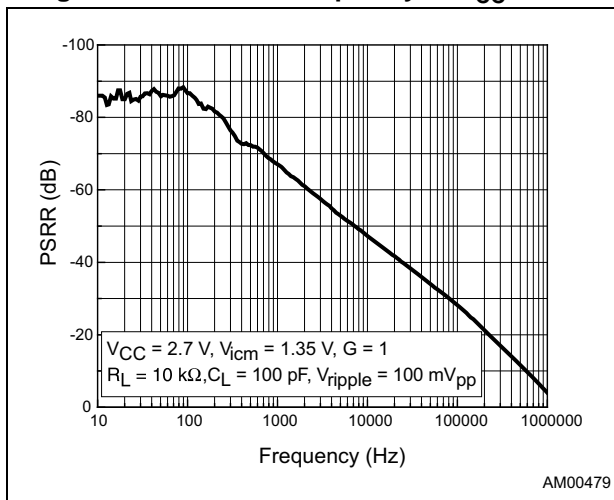
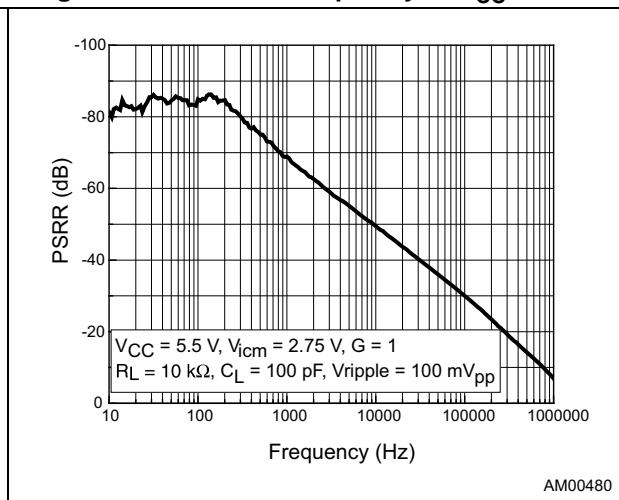

Figure 24. PSRR vs. frequency at  $V_{CC} = 5.5 \text{ V}$



## 4 Application information

### 4.1 Operating voltages

The amplifiers of the TSV52x, TSV52xA series can operate from 2.7 V to 5.5 V. Their parameters are fully specified for 2.7 V, 3.3 V and 5 V power supplies. However, the parameters are very stable in the full  $V_{CC}$  range and several characterization curves show the TSV52x, TSV52xA device characteristics at 2.7 V. Additionally, the main specifications are guaranteed in extended temperature ranges from -40 to +125 °C.

### 4.2 Common-mode voltage range

The TSV52x, TSV52xA devices are built with two complementary PMOS and NMOS input differential pairs. The devices have a rail-to-rail input and the input Common-mode range is extended from  $V_{CC-} - 0.1$  V to  $V_{CC+} + 0.1$  V.

The N channel pair is active for input voltage close to the positive rail typically ( $V_{CC+} - 0.7$  V) to 100 mv above the positive rail.

The P channel pair is active for input voltage close to the negative rail typically 100 mV below the negative rail to  $V_{CC-} + 0.7$  V.

And between  $V_{CC-} + 0.7$  V and  $V_{CC+} - 0.7$  V the both N and P pairs are active.

When the both pairs work together it allows to increase the speed of the TSV52x, TSV52xA devices. This architecture improves the merit factor of the whole device. In the transition region, the performance of CMR, SVR,  $V_{io}$  (Figure 25 and Figure 26) and THD is slightly degraded.

Figure 25. Input offset voltage vs. input common-mode at  $V_{CC} = 2.7$  V



Figure 26. Input offset voltage vs. input common-mode at  $V_{CC} = 5.5$  V

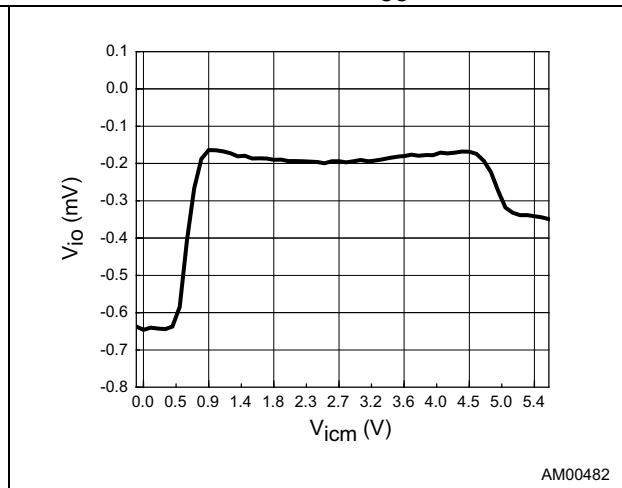

### 4.3 Rail-to-rail input

The TSV52x, TSV52xA series are guaranteed without phase reversal as shown in [Figure 28](#).

It is extremely important that the current flowing in the input pin does not exceed 10 mA. In order to limit this current, a serial resistor can be added on the  $V_{in}$  path.

Figure 27. Phase reversal test schematic



Figure 28. No phase reversal



### 4.4 Rail-to-rail output

The operational amplifier output levels can go close to the rails: 35 mV maximum above and below the rail when connected to a 10 k $\Omega$  resistive load to  $V_{CC}/2$ .

### 4.5 Driving resistive and capacitive loads

To drive high capacitive loads, adding an in series resistor at the output can improve the stability of the device (see [Figure 29](#) for the recommended in series value). Once the in series resistor has been selected, the stability of the circuit should be tested on the bench and simulated with simulation models. The  $R_{load}$  is placed in parallel with the capacitive load. The  $R_{load}$  and the in series resistor create a voltage divider which introduces an error proportional to the ratio  $R_s/R_{load}$ . By keeping  $R_s$  as low as possible, this error is generally negligible.

Figure 29. In series resistor versus capacitive load



### 4.6 Input offset voltage drift over temperature

The maximum input voltage drift over the temperature variation is defined as the offset variation related to offset value measured at 25 °C. The operational amplifier is one of the main circuits of the signal conditioning chain, and the amplifier input offset is a major contributor to the chain accuracy. The signal chain accuracy at 25 °C can be compensated during production at application level. The maximum input voltage drift over temperature enables the system designer to anticipate the effect of temperature variations.

The maximum input voltage drift over temperature is computed using [Equation 1](#).

#### Equation 1

$$\frac{\Delta V_{io}}{\Delta T} = \max \left| \frac{V_{io}(T) - V_{io}(25^\circ\text{C})}{T - 25^\circ\text{C}} \right|$$

with T = -40 °C and 125 °C.

The datasheet maximum value is guaranteed by a measurement on a representative sample size ensuring a C<sub>pk</sub> (process capability index) greater than 1.33.

## 4.7 Long term input offset voltage drift

To evaluate product reliability, two types of stress acceleration are used:

- Voltage acceleration, by changing the applied voltage
- Temperature acceleration, by changing the die temperature (below the maximum junction temperature allowed by the technology) with the ambient temperature.

The voltage acceleration has been defined based on JEDEC results, and is defined using [Equation 2](#).

### Equation 2

$$A_{FV} = e^{\beta \cdot (V_S - V_U)}$$

Where:

$A_{FV}$  is the voltage acceleration factor

$\beta$  is the voltage acceleration constant in  $1/V$ , constant technology parameter ( $\beta = 1$ )

$V_S$  is the stress voltage used for the accelerated test

$V_U$  is the voltage used for the application

The temperature acceleration is driven by the Arrhenius model, and is defined in [Equation 3](#).

### Equation 3

$$A_{FT} = e^{\frac{E_a}{k} \cdot \left( \frac{1}{T_U} - \frac{1}{T_S} \right)}$$

Where:

$A_{FT}$  is the temperature acceleration factor

$E_a$  is the activation energy of the technology based on the failure rate

$k$  is the Boltzmann constant ( $8.6173 \times 10^{-5} \text{ eV} \cdot \text{K}^{-1}$ )

$T_U$  is the temperature of the die when  $V_U$  is used (K)

$T_S$  is the temperature of the die under temperature stress (K)

The final acceleration factor,  $A_F$ , is the multiplication of the voltage acceleration factor and the temperature acceleration factor ([Equation 4](#)).

### Equation 4

$$A_F = A_{FT} \times A_{FV}$$

$A_F$  is calculated using the temperature and voltage defined in the mission profile of the product. The  $A_F$  value can then be used in [Equation 5](#) to calculate the number of months of use equivalent to 1000 hours of reliable stress duration.



**Equation 5**

$$\text{Months} = A_F \times 1000 \text{ h} \times 12 \text{ months} / (24 \text{ h} \times 365.25 \text{ days})$$

To evaluate the op-amp reliability, a follower stress condition is used where  $V_{CC}$  is defined as a function of the maximum operating voltage and the absolute maximum rating (as recommended by JEDEC rules).

The  $V_{io}$  drift (in  $\mu\text{V}$ ) of the product after 1000 h of stress is tracked with parameters at different measurement conditions (see [Equation 6](#)).

**Equation 6**

$$V_{CC} = \max V_{op} \text{ with } V_{icm} = V_{CC} / 2$$

The long term drift parameter ( $\Delta V_{io}$ ), estimating the reliability performance of the product, is obtained using the ratio of the  $V_{io}$  (input offset voltage value) drift over the square root of the calculated number of months ([Equation 7](#)).

**Equation 7**

$$\Delta V_{io} = \frac{V_{io} \text{ drift}}{\sqrt{(\text{months})}}$$

where  $V_{io}$  drift is the measured drift value in the specified test conditions after 1000 h stress duration.

**4.8 PCB layouts**

For correct operation, it is advised to add 10 nF decoupling capacitors as close as possible to the power supply pins.

**4.9 Macromodel**

Accurate macromodels of the TSV52x, TSV52xA devices are available on STMicroelectronics™ website at [www.st.com](http://www.st.com). These models are a trade-off between accuracy and complexity (that is, time simulation) of the TSV52x, TSV52xA operational amplifiers. They emulate the nominal performance of a typical device within the specified operating conditions mentioned in the datasheet. They also help to validate a design approach and to select the appropriate operational amplifier, *but they do not replace on-board measurements*.

## 5 Package information

In order to meet environmental requirements, ST offers these devices in different grades of ECOPACK<sup>®</sup> packages, depending on their level of environmental compliance. ECOPACK specifications, grade definitions and product status are available at: [www.st.com](http://www.st.com). ECOPACK is an ST trademark.

### 5.1 SC705 package information

Figure 30. SC70-5 package outline



Table 7. SC70-5 package mechanical data

| Ref      | Dimensions  |      |      |        |       |       |
|----------|-------------|------|------|--------|-------|-------|
|          | Millimeters |      |      | Inches |       |       |
|          | Min.        | Typ. | Max. | Min.   | Typ.  | Max.  |
| A        | 0.80        |      | 1.10 | 0.032  |       | 0.043 |
| A1       | 0           |      | 0.10 |        |       | 0.004 |
| A2       | 0.80        | 0.90 | 1.00 | 0.032  | 0.035 | 0.039 |
| b        | 0.15        |      | 0.30 | 0.006  |       | 0.012 |
| c        | 0.10        |      | 0.22 | 0.004  |       | 0.009 |
| D        | 1.80        | 2.00 | 2.20 | 0.071  | 0.079 | 0.087 |
| E        | 1.80        | 2.10 | 2.40 | 0.071  | 0.083 | 0.094 |
| E1       | 1.15        | 1.25 | 1.35 | 0.045  | 0.049 | 0.053 |
| e        |             | 0.65 |      |        | 0.025 |       |
| e1       |             | 1.30 |      |        | 0.051 |       |
| L        | 0.26        | 0.36 | 0.46 | 0.010  | 0.014 | 0.018 |
| $\alpha$ | 0°          |      | 8°   |        |       |       |

## 5.2 DFN8 2x2 package information

Figure 31. DFN8 2x2x0.6, 8 pitch, 0.5 mm package outline



Table 8. DFN8 2x2x0.6, 8 pitch, 0.5 mm package mechanical data

| Ref. | Dimensions  |      |       |        |       |       |
|------|-------------|------|-------|--------|-------|-------|
|      | Millimeters |      |       | Inches |       |       |
|      | Min.        | Typ. | Max.  | Min.   | Typ.  | Max.  |
| A    | 0.51        | 0.55 | 0.60  | 0.020  | 0.022 | 0.024 |
| A1   |             |      | 0.05  |        |       | 0.002 |
| A3   |             | 0.15 |       |        | 0.006 |       |
| b    | 0.18        | 0.25 | 0.30  | 0.007  | 0.010 | 0.012 |
| D    | 1.85        | 2.00 | 2.15  | 0.073  | 0.079 | 0.085 |
| D2   | 1.45        | 1.60 | 1.70  | 0.057  | 0.063 | 0.067 |
| E    | 1.85        | 2.00 | 2.15  | 0.073  | 0.079 | 0.085 |
| E2   | 0.75        | 0.90 | 1.00  | 0.030  | 0.035 | 0.039 |
| e    |             | 0.50 |       |        | 0.020 |       |
| L    |             |      | 0.425 |        |       | 0.017 |
| ddd  |             |      | 0.08  |        |       | 0.003 |

Figure 32. DFN8 2x2x0.6, 8 pitch, 0.5 mm footprint recommendation



### 5.3 MiniSO8 package information

Figure 33. MiniSO8 package outline



Table 9. MiniSO8 package mechanical data

| Symbol     | Dimensions  |      |      |        |       |       |
|------------|-------------|------|------|--------|-------|-------|
|            | Millimeters |      |      | Inches |       |       |
|            | Min.        | Typ. | Max. | Min.   | Typ.  | Max.  |
| <b>A</b>   |             |      | 1.10 |        |       | 0.043 |
| <b>A1</b>  | 0           |      | 0.15 | 0      |       | 0.006 |
| <b>A2</b>  | 0.75        | 0.85 | 0.95 | 0.030  | 0.033 | 0.037 |
| <b>b</b>   | 0.22        |      | 0.40 | 0.009  |       | 0.016 |
| <b>c</b>   | 0.08        |      | 0.23 | 0.003  |       | 0.009 |
| <b>D</b>   | 2.80        | 3.00 | 3.20 | 0.11   | 0.118 | 0.126 |
| <b>E</b>   | 4.65        | 4.90 | 5.15 | 0.183  | 0.193 | 0.203 |
| <b>E1</b>  | 2.80        | 3.00 | 3.10 | 0.11   | 0.118 | 0.122 |
| <b>e</b>   |             | 0.65 |      |        | 0.026 |       |
| <b>L</b>   | 0.40        | 0.60 | 0.80 | 0.016  | 0.024 | 0.031 |
| <b>L1</b>  |             | 0.95 |      |        | 0.037 |       |
| <b>L2</b>  |             | 0.25 |      |        | 0.010 |       |
| <b>k</b>   | 0°          |      | 8°   | 0°     |       | 8°    |
| <b>ccc</b> |             |      | 0.10 |        |       | 0.004 |

### 5.4 QFN16 3x3 package information

Figure 34. QFN16 3x3x0.9 mm, pad 1.7 package outline



Table 10. QFN16 3x3x0.9 mm, pad 1.7 package mechanical data

| Symbol | Dimensions  |      |      |        |       |       |
|--------|-------------|------|------|--------|-------|-------|
|        | Millimeters |      |      | Inches |       |       |
|        | Nom.        | Min. | Max. | Nom.   | Min.  | Max.  |
| A      | 0.90        | 0.80 | 1.00 | 0.035  | 0.032 | 0.039 |
| A1     |             | 0.00 | 0.05 |        | 0.000 | 0.002 |
| A3     | 0.20        |      |      | 0.008  |       |       |
| b      |             | 0.18 | 0.30 |        | 0.007 | 0.012 |
| D      | 3.00        | 2.90 | 3.10 | 0.118  | 0.114 | 0.122 |
| D2     |             | 1.50 | 1.80 |        | 0.061 | 0.071 |
| E      | 3.00        | 2.90 | 3.10 | 0.118  | 0.114 | 0.122 |
| E2     |             | 1.50 | 1.80 |        | 0.061 | 0.071 |
| e      | 0.50        |      |      | 0.020  |       |       |
| L      |             | 0.30 | 0.50 |        | 0.012 | 0.020 |

Figure 35. QFN16 3x3x0.9 mm, pad 1.7 footprint recommendation





### 5.5 TSSOP14 package information

Figure 36. TSSOP14 body 4.40 mm, lead pitch 0.65 mm package outline

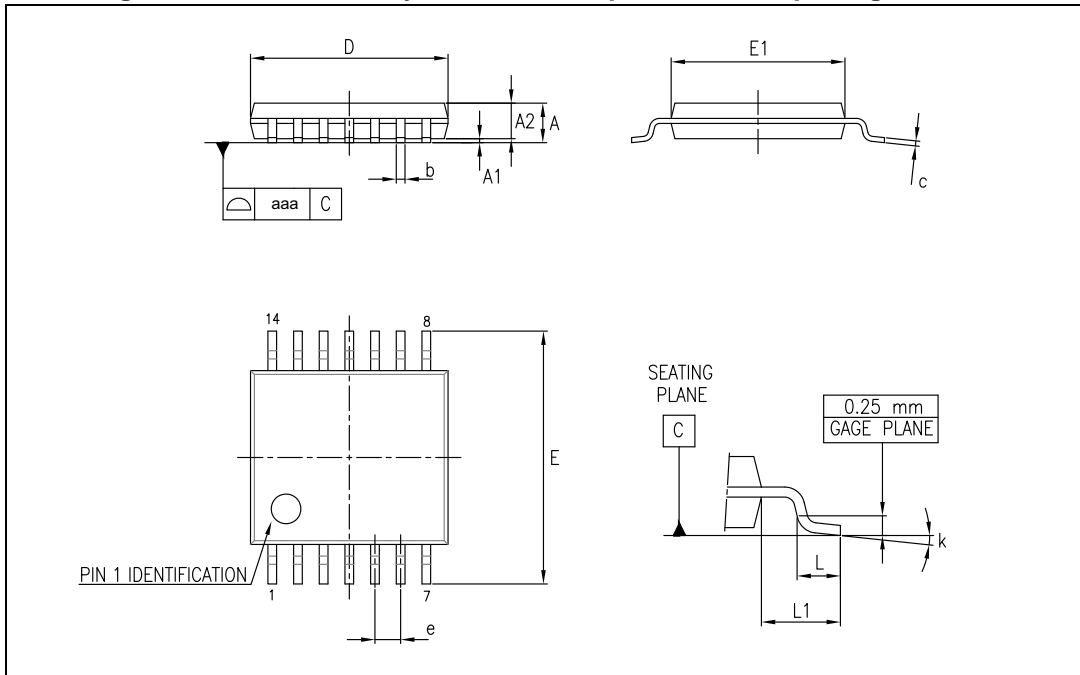

Table 11. TSSOP14 body 4.40 mm, lead pitch 0.65 mm package mechanical data

| Symbol | Dimensions  |      |      |        |            |        |
|--------|-------------|------|------|--------|------------|--------|
|        | Millimeters |      |      | Inches |            |        |
|        | Min.        | Typ. | Max. | Min.   | Typ.       | Max.   |
| A      |             |      | 1.20 |        |            | 0.047  |
| A1     | 0.05        |      | 0.15 | 0.002  | 0.004      | 0.006  |
| A2     | 0.80        | 1.00 | 1.05 | 0.031  | 0.039      | 0.041  |
| b      | 0.19        |      | 0.30 | 0.007  |            | 0.012  |
| c      | 0.09        |      | 0.20 | 0.004  |            | 0.0089 |
| D      | 4.90        | 5.00 | 5.10 | 0.193  | 0.197      | 0.201  |
| E      | 6.20        | 6.40 | 6.60 | 0.244  | 0.252      | 0.260  |
| E1     | 4.30        | 4.40 | 4.50 | 0.169  | 0.173      | 0.176  |
| e      |             | 0.65 |      |        | 0.0256 BSC |        |
| L      | 0.45        | 0.60 | 0.75 |        |            |        |
| L1     |             | 1.00 |      |        |            |        |
| k      | 0°          |      | 8°   | 0°     |            | 8°     |
| aaa    |             |      | 0.10 | 0.018  | 0.024      | 0.030  |

## 6 Ordering information

Table 12. Order codes

| Order code  | Temperature range                                | Package     | Packing       | Marking  |
|-------------|--|-------------|---------------|----------|
| TSV521ICT   | -40 to 125 °C                                    | SC70-5      | Tape and reel | K1G      |
| TSV522IQ2T  |  | DFN8 2 x 2  |               | K1G      |
| TSV522IST   |  | MiniSO8     |               | K1G      |
| TSV524IQ4T  |  | QFN16 3 x 3 |               | K1G      |
| TSV524IPT   |  | TSSOP14     |               | TSV524   |
| TSV522IYST  | -40 to 125 °C<br>Automotive grade <sup>(1)</sup> | MiniSO8     |               | K1H      |
| TSV524IYPT  |  | TSSOP14     |               | TSV524Y  |
| TSV521AICT  | -40 to 125 °C                                    | SC70-5      |               | K1K      |
| TSV522AIQ2T |  | DFN8 2 x 2  |               | K1K      |
| TSV522AIST  |  | MiniSO8     |               | K1K      |
| TSV524AIQ4T |  | QFN16 3 x 3 |               | K1K      |
| TSV524AIPT  |  | TSSOP14     |               | TSV524A  |
| TSV522AIYST | -40 to 125 °C<br>Automotive grade <sup>(1)</sup> | MiniSO8     |               | K1L      |
| TSV524AIYPT |  | TSSOP14     |               | TSV524AY |

1. Qualification and characterization according to AEC Q100 and Q003 or equivalent, advanced screening according to AEC Q001 and Q 002 or equivalent.

## 7 Revision history

Table 13. Document revision history

| Date        | Revision | Changes   |
|-------------|----------|---|
| 19-Jun-2012 | 1        | Initial release.  |
| 31-Jan-2014 | 2        | Updated information of “ <i>Related products</i> ”<br>“ <i>Figure 1: Pin connections for each package (top view)</i> ”: added footnote 1.<br>“ <i>Section 4: Application information</i> ”: updated text to make it more readable<br>“ <i>Table 12</i> ”: updated automotive footnotes. |
| 12-Apr-2017 | 3        | Updated <a href="#">Table 8</a> : “L” dimension changed from 0.5 mm to 0.425 mm.  |

**IMPORTANT NOTICE – PLEASE READ CAREFULLY**

STMicroelectronics NV and its subsidiaries ("ST") reserve the right to make changes, corrections, enhancements, modifications, and improvements to ST products and/or to this document at any time without notice. Purchasers should obtain the latest relevant information on ST products before placing orders. ST products are sold pursuant to ST's terms and conditions of sale in place at the time of order acknowledgement.

Purchasers are solely responsible for the choice, selection, and use of ST products and ST assumes no liability for application assistance or the design of Purchasers' products.

No license, express or implied, to any intellectual property right is granted by ST herein.

Resale of ST products with provisions different from the information set forth herein shall void any warranty granted by ST for such product.

ST and the ST logo are trademarks of ST. All other product or service names are the property of their respective owners.

Information in this document supersedes and replaces information previously supplied in any prior versions of this document.

© 2017 STMicroelectronics – All rights reserved



## Стандарт Электрон Связь

Мы молодая и активно развивающаяся компания в области поставок электронных компонентов. Мы поставляем электронные компоненты отечественного и импортного производства напрямую от производителей и с крупнейших складов мира.

Благодаря сотрудничеству с мировыми поставщиками мы осуществляем комплексные и плановые поставки широчайшего спектра электронных компонентов.

Собственная эффективная логистика и склад в обеспечивает надежную поставку продукции в точно указанные сроки по всей России.

Мы осуществляем техническую поддержку нашим клиентам и предпродажную проверку качества продукции. На все поставляемые продукты мы предоставляем гарантию .

Осуществляем поставки продукции под контролем ВП МО РФ на предприятия военно-промышленного комплекса России , а также работаем в рамках 275 ФЗ с открытием отдельных счетов в уполномоченном банке. Система менеджмента качества компании соответствует требованиям ГОСТ ISO 9001.

Минимальные сроки поставки, гибкие цены, неограниченный ассортимент и индивидуальный подход к клиентам являются основой для выстраивания долгосрочного и эффективного сотрудничества с предприятиями радиоэлектронной промышленности, предприятиями ВПК и научно-исследовательскими институтами России.

С нами вы становитесь еще успешнее!

### Наши контакты:

**Телефон:** +7 812 627 14 35

**Электронная почта:** [sales@st-electron.ru](mailto:sales@st-electron.ru)

**Адрес:** 198099, Санкт-Петербург,  
Промышленная ул, дом № 19, литера Н,  
помещение 100-Н Офис 331