

## 5V/1.5A Backup Battery Pack Manager

### FEATURES

- Dedicated Single Chip Solution for Mobile Power With Minimal Component Count
- 5V/1.5A Constant Output Current Limit in Boost Mode
- 1.5A Switching Charger Limit
- Programmable 4.1V to 4.35V Battery Voltage
- 95% Boost Efficiency (Vbat=4.1V)
- Adaptive to 10mA-2400mA Input Sources
- Battery Disconnection at Output Short
- <10 $\mu$ A Low Battery Leakage Current at HZ Mode During Storage
- Boost Auto Turn-off at No Load and Push Button Turn-on
- Battery Over Current, Over Voltage, Over Temperature and Short Circuit Protections
- Boost Auto Startup with Load Detection
- Up to 2.0A Input Current Limit with Prioritized Power Path to Output
- 5V $\pm$ 100mV Output Voltage in Boost Mode
- 1.1MHz/0.55MHz Switching Frequencies
- 2.2 $\mu$ H SMD Inductor and Low Profile Ceramic Capacitor
- 4 LEDs Battery Level and Status Indication
- Battery Impedance Compensation
- Full Cycle of Battery Charge Management Preconditioning, Fast Charge, Top off and End of Charge
- Charge Current Foldback at 110 $^{\circ}$ C Die Temperature
- IC Over Temperature Protection at 160 $^{\circ}$ C
- QFN4x4-24 Package

### APPLICATIONS

- Backup Battery Pack
- Power Bank
- Mobile Power
- Standalone Battery Charger with USB Output

### GENERAL DESCRIPTION

ACT2801/ACT2801B/ACT2801C is a space-saving and high-performance low-profile single-chip solution for backup battery pack and standalone battery charger. ACT2801/ACT2801B/ACT2801C integrates all the functions that a backup battery pack needs, including switching charger, boost converter and LED indication.

ACT2801/ACT2801B/ACT2801C operates at 1.1MHz for switching charger and 0.55MHz for boost converter allowing tiny external inductor and capacitors. ACT2801/ACT2801B/ACT2801C provides a direct power path from input to output with programmable current limit while providing power to switching charger. Output has higher priority than battery charger if the programmed input current limit is reached.

ACT2801/ACT2801B/ACT2801C charges battery with full cycle of preconditioning, fast charge with constant current and constant voltage until end of charge. The battery charger is thermally regulated at 110 $^{\circ}$ C with charge current foldback.

ACT2801/ACT2801B/ACT2801C boost converter steps battery voltage up to 5V. Boost converter features high efficiency, constant current regulation, short circuit protection and over voltage protection.

ACT2801/ACT2801B/ACT2801C provides 3.5mA constant currents to drive 4 LEDs to indicate battery level and charge status. Battery impedance is compensated for battery level indication.

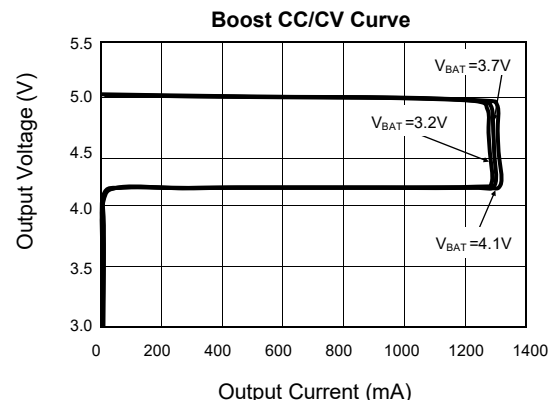
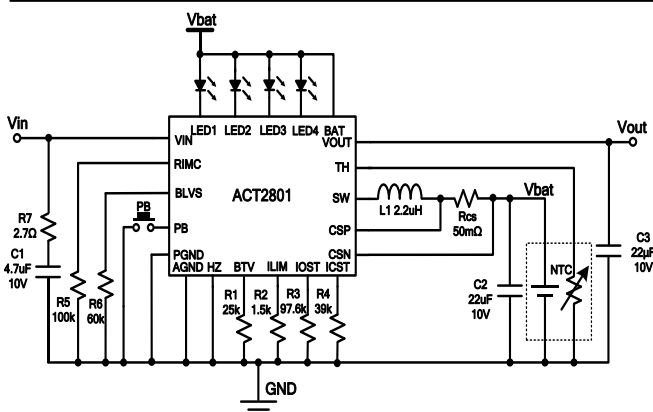

## ORDERING INFORMATION

| PART NUMBER      | OUTPUT  | FLASHLIGHT | PB TURN OFF BOOST | LEDS ALWAYS ON IN BOOST | LATCH OFF AT BOOST UVLO | BOOST LIGHT LOAD OFF TIME | PACKAGE  |
|------------------|---------|------------|-------------------|-------------------------|-------------------------|---------------------------|----------|
| ACT2801QL-T1028  | 5V/1.5A | No         | Yes               | No                      | Yes                     | 16s                       | QFN44-24 |
| ACT2801BQL-T1028 | 5V/1.5A | Yes        | No                | Yes                     | Yes                     | 16s                       | QFN44-24 |
| ACT2801CQL-T1028 | 5V/1.5A | Yes        | No                | No                      | Yes                     | 16s                       | QFN44-24 |

## PIN CONFIGURATION

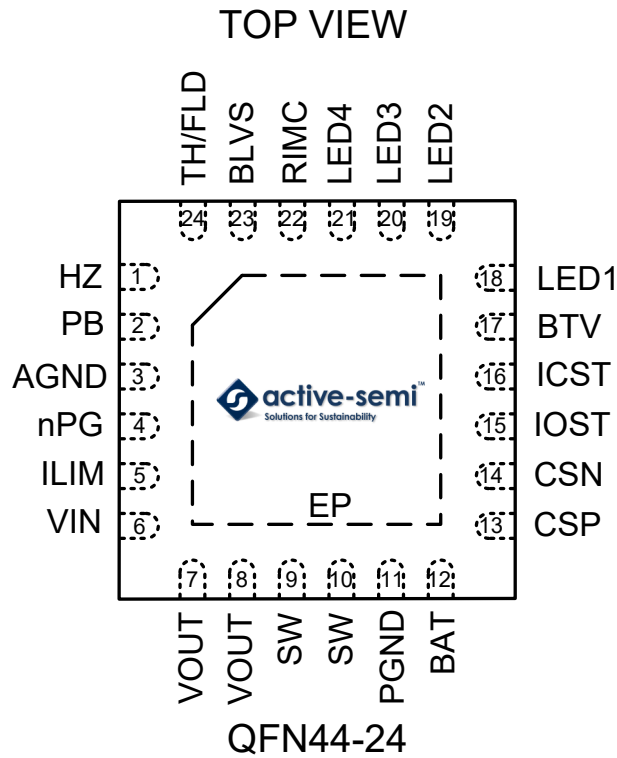

## PIN DESCRIPTIONS

| PIN   | NAME   | DESCRIPTION   |
|-------|--------|---|
| 1     | HZ     | Boost/high-Z mode enable pin, internally pulled up by a 3M $\Omega$ resistor to battery. When HZ pin is pulled ground, boost is enabled if VIN is not present.  |
| 2     | PB     | Push button input, connect a push button from this pin to AGND, internally pulled up by a 3M $\Omega$ resistor to battery. PB starts up boost converter if HZ pin is grounded and VIN is not present. For ACT2801B/ACT2801C, if this pin is pushed for 3s, flashlight is enabled. |
| 3     | AGND   | Logic Ground. AGND must be connected to PGND externally through ground plane.   |
| 4     | nPG    | Drive external P-FET to protect output short circuit and leakage during shutdown. nPG pin is pulled up to VOUT internally. nPG pin is pulled low if VOUT is in the range.   |
| 5     | ILIM   | Input current limit setting pin. Connect a resistor from this pin to AGND to set the input current limit. The current setting ranges from 0.5A-2.0A.  |
| 6     | VIN    | USB or AC adaptor input. When VIN is valid, charge and power path is enabled.   |
| 7, 8  | VOUT   | Output pin. Bypass to PGND with a high quality low ESR and ESL ceramic capacitor placed as close to the IC as possible.   |
| 9, 10 | SW     | Internal switch to output inductor terminal.  |
| 11    | PGND   | Power ground. PGND is connected to the source of low-side N-channel MOSFET and the MOSFET's gate driver. PGND must be connected to AGND externally through ground plane.  |
| 12    | BAT    | Battery input. Connected to the battery pack positive terminal to provide power in High-Z mode. Bypass to PGND with a high quality ceramic capacitor placed as close to the IC as possible.   |
| 13    | CSP    | Positive terminal of charge current sense input. Kevin sense is required with 10nF ceramic capacitor right across CSP and CSN pins.   |
| 14    | CSN    | Negative terminal of charge current sense input.  |
| 15    | IOST   | Output current setting. Connect a resistor from this pin to AGND to set output constant current. The current setting ranges from 0.5A-1.5A.   |
| 16    | ICST   | Fast charge current setting pin. Connect a resistor from this pin to AGND to set the charge current. The current setting ranges from 0.5A-1.5A.   |
| 17    | BTV    | Battery termination voltage setting. Connect a resistor from this pin to AGND to program battery charge termination voltage.  |
| 18    | LED1   | Battery level indicator. An internal 3.5mA sink current limit is built in.  |
| 19    | LED2   | Battery level indicator. An internal 3.5mA sink current limit is built in.  |
| 20    | LED3   | Battery level indicator. An internal 3.5mA sink current limit is built in.  |
| 21    | LED4   | Battery level indicator. An internal 3.5mA sink current limit is built in.  |
| 22    | RIMC   | Battery impedance compensation input. Connect to a resistor from this pin to APNG to program the battery impedance.   |
| 23    | BLVS   | Battery level voltage shift. Connect a resistor from this pin to AGND to shift the battery LED indication thresholds.   |
| 24    | TH/FLD | TH: ACT2801<br>Temperature sensing input. Connect to battery thermistor terminal. If not use, put 10K pull down resistor to AGND.<br>FLD: ACT2801B/ACT2801C<br>Open-drain flashlight driver. A internal switch can handle up to 50mA.   |
| 25    | EP     | Exposed pad. Must be soldered to ground on the PCB.   |

**ABSOLUTE MAXIMUM RATINGS**<sup>①</sup>

| PARAMETER                              | VALUE       | UNIT |
|--|-------------|------|
| All the Pin to PGND and AGND           | -0.3 to 6.5 | V    |
| Junction to Ambient Thermal Resistance | 40          | °C/W |
| Maximum Power Dissipation              | 2.5         | W    |
| Operating Ambient Temperature          | -40 to 85   | °C   |
| Operating Junction Temperature         | -40 to 150  | °C   |
| Storage Junction Temperature           | -40 to 150  | °C   |
| Lead Temperature (Soldering 10 sec.)   | 300         | °C   |

①: Do not exceed these limits to prevent damage to the device. Exposure to absolute maximum rating conditions for long periods may affect device reliability.

## ELECTRICAL CHARACTERISTICS

( $V_{IN} = 5V$ ,  $T_A = 25^\circ C$ , unless otherwise specified.)

| PARAMETER                                      | TEST CONDITIONS   | MIN   | TYP             | MAX  | UNIT       |
|--|---|-------|-----------------|------|------------|
| <b>Input Current Limit</b>                     |   |       |                 |      |            |
| Input Voltage Range                            |   | 4.5   |                 | 5.5  | V          |
| $V_{IN}$ Over Voltage Protection               | $V_{IN}$ rising, $V_{IN\_OVP}$                              | 5.5   | 6.0             | 6.5  | V          |
| Input Voltage Validation Time                  | $V_{IN\_UVLO} < V_{IN} < V_{IN\_OVP}$                       |       | 32              |      | ms         |
| Input Current Limit Setting Range              | $R_{ILIM} = 1.2k\Omega - 4.8k\Omega$                        | 0.5   |                 | 2.0  | A          |
| Input Current Setting                          | $R_{ILIM} = 1.5k\Omega$                                     |       | 1.6             |      | A          |
| Input Current Limit Gain                       |   |       | 2000            |      |            |
| Leakage Current from VOUT to VIN in Boost Mode | $3.0V < V_{BAT} < 4.35V$ , $T_a = 25^\circ C$               |       | 0               | 10   | $\mu A$    |
| Battery Discharge Current in High-Z Mode       | $3.0V < V_{BAT} < 4.35V$ , $T_a = 25^\circ C$               |       | 7.5             | 15   | $\mu A$    |
| <b>Power Switches</b>                          |   |       |                 |      |            |
| VIN-to-VOUT FET on Resistance                  |   |       | 90              |      | m $\Omega$ |
| VOUT-to-SW FET on Resistance                   |   |       | 70              |      | m $\Omega$ |
| SW-to-PGND FET on Resistance                   |   |       | 75              |      | m $\Omega$ |
| <b>Buck Converter</b>                          |   |       |                 |      |            |
| Switching Frequency                            |   | -15%  | 1.1             | +15% | MHz        |
| High Side Switch Peak Current Limit            |   | 4.5   | 6               |      | A          |
| Minimum On-time                                |   |       | 100             |      | ns         |
| Over Temperature Protection (OTP)              | OTP rising  |       | 160             |      | $^\circ C$ |
| OTP Hysteresis                                 | OTP falling   |       | 35              |      | $^\circ C$ |
| <b>Charge Mode</b>                             |   |       |                 |      |            |
| Charge Current Setting Range                   | $R_{CS} = 50m\Omega$ , $R_{ICST} = 20k\Omega - 60.4k\Omega$ | 0.5   |                 | 1.5  | A          |
| Charge Current Setting ( $I_{CHRG}$ )          | $R_{CS} = 50m\Omega$ , $R_{ICST} = 39k\Omega$               | -10%  | 975             | +10% | mA         |
| Thermal Regulation Temperature                 |   |       | 110             |      | $^\circ C$ |
| Battery Adjust Voltage ( $V_{BAJ}$ )           | $R_{btv} = 25k\Omega$                                       |       | 0.1             |      | V          |
| End of Charge (EOC) Voltage                    |   | -0.5% | $4.1 + V_{BAJ}$ | 0.5% | V          |
| EOC Voltage Accuracy                           | $R_{btv} = 0$   |       | 4.1             |      | V          |
| Battery Over Voltage Threshold                 | VBAT rising   |       | 4.6             |      | V          |
| Battery Over Voltage Threshold Hysteresis      | VBAT falling  |       | 200             |      | mV         |

## ELECTRICAL CHARACTERISTICS

( $V_{IN} = 5V$ ,  $T_A = 25^\circ C$ , unless otherwise specified.)

| PARAMETER   | TEST CONDITIONS  | MIN  | TYP        | MAX  | UNIT    |
|---|--|------|------------|------|---------|
| Fast Charge Current                               | $V_{BAT}=3.5V$   |      | $I_{CHRG}$ |      | A       |
| Precondition Charge Current                       | $2.5V \leq V_{BAT} \leq 2.8V$ , Percent of $I_{CHRG}$          |      | 10         |      | %       |
| Precondition Voltage Threshold                    | $V_{BAT}$ rising, $R_{btv}=0$                                  |      | 2.8        |      | V       |
| Precondition Voltage Threshold Hysteresis         |  |      | 130        |      | mV      |
| Low $V_{BAT}$ Charge Current                      | $V_{BAT}=1V$ , $R_{ICST}=39k\Omega$                            |      | 200        |      | mA      |
| EOC Current Threshold                             | Percent of the fast charge current                             |      | 13         |      | %       |
| Charge Restart Voltage Threshold                  |  |      | 200        |      | mV      |
| TH Upper Temperature Voltage Threshold            | Cold detect NTC thermistor, ACT2801                            | 1.45 | 1.5        | 1.55 | V       |
| TH Lower Temperature Voltage Threshold            | Hot detect NTC thermistor, ACT2801                             | 0.28 | 0.3        | 0.32 | V       |
| TH Hysteresis                                     | ACT2801  | 20   | 50         | 80   | mV      |
| TH Internal Pull-up Current                       | ACT2801  |      | 60         |      | $\mu A$ |
| LED Flash Frequency                               | LED flash 1s on and 1s off                                     |      | 0.5        |      | Hz      |
| <b>Charge Current Foldback</b>                    |  |      |            |      |         |
| Charge Current Reduction Threshold1 of $V_{out1}$ | Starting foldback point  | 4.59 | 4.7        | 4.81 | V       |
| Charge Current Reduction Threshold2 of $V_{out1}$ | Stop foldback point, $R_{CS}=50m\Omega$ , $R_{ICST}=39k\Omega$ |      | 4.57       |      | V       |
| <b>Boost Mode</b>                                 |  |      |            |      |         |
| Input Voltage Operation Range                     |  | 3.0  |            | 4.5  | V       |
| Switching Frequency                               |  | -15% | 0.55       | +15% | MHz     |
| Input Voltage UVLO                                | $V_{BAT}$ rising   | 3.15 | 3.3        | 3.45 | V       |
| Input Voltage UVLO Hysteresis                     | $V_{BAT}$ falling  | 300  | 400        | 500  | mV      |
| Output Voltage ( $V_{OUT}$ )                      | $T_a=25^\circ C$   | 4.97 | 5.05       | 5.10 | V       |
| Output Voltage Accuracy                           | All conditions   | -3   | $V_{OUT}$  | 2    | %       |
| Output Voltage Transient Response                 | $V_{bat}=3.7V$ , 80mA-1A-80mA, 0.1A/us                         | 4.75 |            | 5.25 | V       |
| Output Over Voltage Protection                    | $V_{OUT}$ rising   |      | 5.7        |      | V       |
| Output Over Voltage Protection Hysteresis         | $V_{OUT}$ falling  |      | 300        |      | mV      |
| Output Current Regulation Range                   | $R_{cs}=50m\Omega$ , $R_{IOST}=37.5k\Omega-113k\Omega$         | 0.5  |            | 1.5  | A       |

## ELECTRICAL CHARACTERISTICS

 ( $V_{IN} = 5V$ ,  $T_A = 25^\circ C$ , unless otherwise specified.)

| PARAMETER  | TEST CONDITIONS   | MIN  | TYP  | MAX  | UNIT       |
|--|---|------|------|------|------------|
| Output Current Setting                                     | $R_{CS}=50m\Omega$ , $R_{I_{OST}}=97.6k\Omega$                  | -10% | 1.3  | +10% | A          |
| The Maximum Voltage Across VRcs                            | All conditions  |      | 200  |      | mV         |
| Minimum On-Time  |   |      | 100  |      | ns         |
| Low Side Switch Peak Current Limit                         | $V_{BAT}=3.2V$ , $V_{OUT}=5V$                                   | 4.0  | 5.6  |      | A          |
| Soft-Startup Time  |   |      | 400  |      | $\mu s$    |
| Under Voltage Protection (UVP Threshold)                   | VOUT falling  |      | 4.25 |      | V          |
|  | VOUT rising   |      | 4.6  |      | V          |
| UVP Blanking Time During Startup                           |   |      | 3    |      | ms         |
| UVP Sense Detection Time                                   | VOUT falling  |      | 20   |      | $\mu s$    |
| Restart After UVP  | Hiccup mode   |      | 2    |      | s          |
| Light Load Current Shut off Threshold                      | $V_{BAT}=3.7V$ , $R_{CS}=50m\Omega$ , $R_{I_{OST}}=97.6k\Omega$ |      | 40   | 100  | mA         |
| Light Load Current Detect Time                             |   |      | 16   |      | s          |
| HZ Pin High Voltage  | HZ voltage rising   |      | 0.9  | 1.4  | V          |
| HZ Pin Low Voltage   | HZ voltage falling  | 0.4  | 0.75 |      | V          |
| HZ Internal Pull-up Resistor                               |   |      | 3    |      | M $\Omega$ |
| PB Turn off Boost Time                                     | ACT2801   |      | 1.5  |      | s          |
| PB Turn on Boost Time                                      | All condition   |      | 30   |      | ms         |
| LED Indication Time  | PB is pushed and released, ACT2801/<br>ACT2801C                 |      | 5    |      | s          |
| <b>Mode Transition</b>                                     |   |      |      |      |            |
| Transition Waiting Time between Charge Mode and Boost Mode | TRANTIME  |      | 2    |      | s          |
| <b>Battery Level Indication</b>                            |   |      |      |      |            |
| Battery Impedance Compensation Range                       |   | 40   |      | 500  | m $\Omega$ |
| Battery Impedance Compensation                             | $R_{CS}=50m\Omega$ , $R_{IMC}=100k\Omega$                       |      | 200  |      | m $\Omega$ |
| PB High Input Voltage                                      | PB voltage rising   |      | 0.9  | 1.4  | V          |
| PB Low Input Voltage                                       | PB voltage falling  | 0.4  | 0.75 |      | V          |
| PB Internal Pull-up Resistor                               |   |      | 3    |      | M $\Omega$ |

## ELECTRICAL CHARACTERISTICS

( $V_{IN} = 5V$ ,  $T_A = 25^\circ C$ , unless otherwise specified.)

| PARAMETER                         | TEST CONDITIONS                           | MIN | TYP | MAX | UNIT |
|-----------------------------------|---|-----|-----|-----|------|
| <b>Flashlight Driver</b>          |   |     |     |     |      |
| Flashlight Voltage UVLO           | Flashlight rising, ACT2801B/ACT2801C      |     | 3.3 |     | V    |
| Flashlight Voltage UVLO Threshold | Flashlight falling, ACT2801B/ACT2801C     |     | 2.9 |     | V    |
| Flashlight Driver Current         | the current at FLD pin, ACT2801B/ACT2801C |     | 50  |     | mA   |
| PB Turn on Flashlight Time        | ACT2801B/ACT2801C                         |     | 3.0 |     | s    |
| PB Turn off Flashlight Time       | ACT2801B/ACT2801C                         |     | 3.0 |     | s    |



**FUNCTIONAL BLOCK DIAGRAM FOR ACT2801**

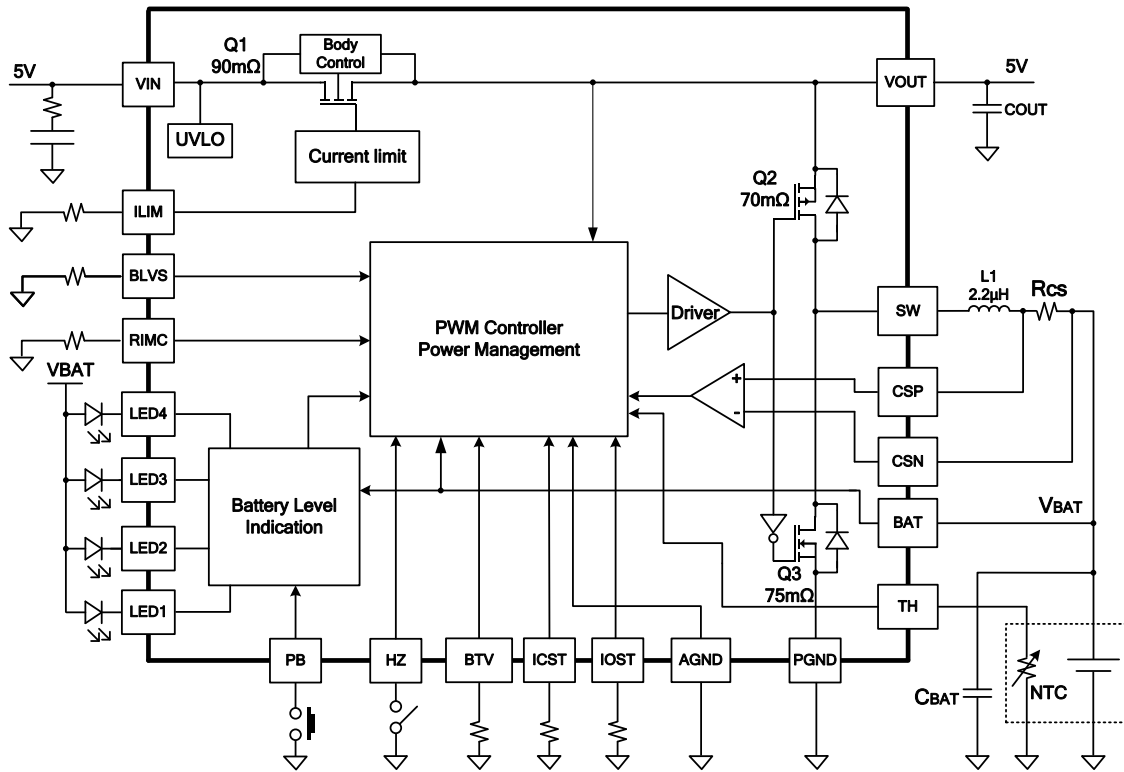

**FUNCTIONAL BLOCK DIAGRAM FOR ACT2801B/ACT2801C**

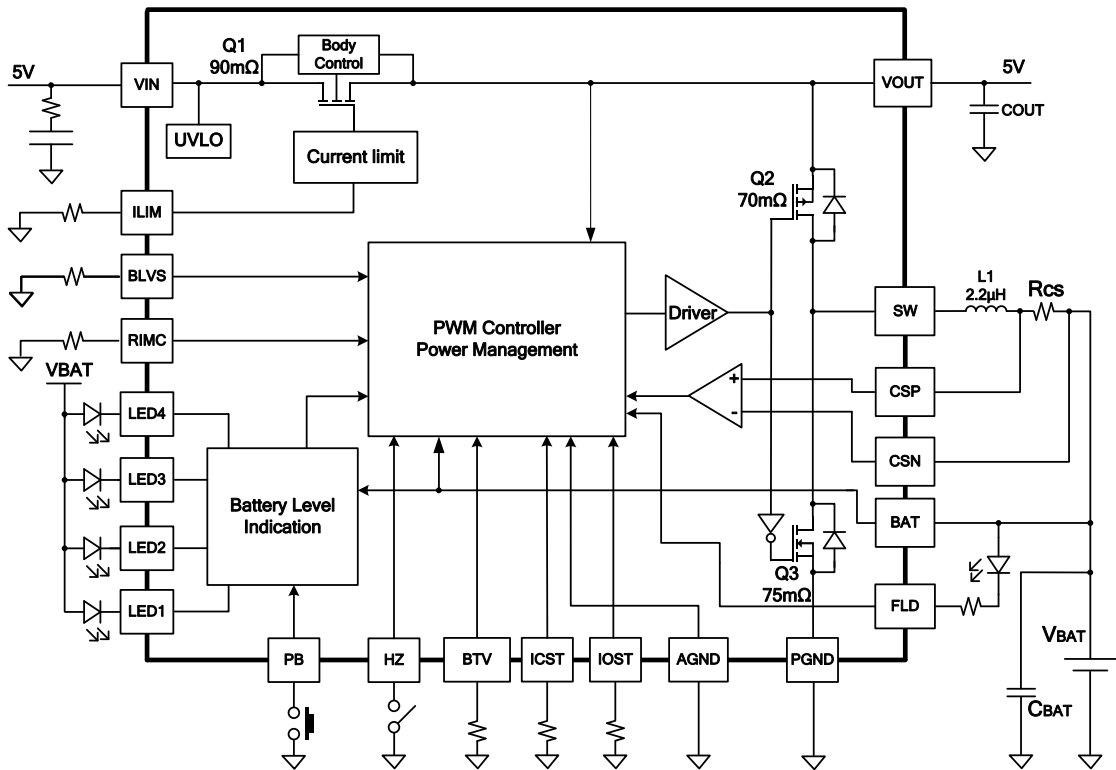

## FUNCTIONAL DESCRIPTION

ACT2801/ACT2801B/ACT2801C is a complete battery charging and discharging power management solution for applications of single-cell lithium-based backup battery pack or power bank. There is a power path from input to output with programmable input current limit. When output is over loaded, the input switch Q1 starts going into linear mode and thus output voltage starts to drop. If output voltage drops below 4.25V, the input switch Q1 turns off and restart in 2 seconds.

With the advanced ACT2801/ACT2801B/ACT2801C architecture, a synchronous buck/boost converter is connected from VOUT to switching node (SW). With the bidirectional architecture, the converter could be configured as either buck to charge battery or boost to discharge battery. With switching charger and discharger, the higher charge current and higher conversion efficiency are achieved.

### Modes of Operation

ACT2801/ACT2801B/ACT2801C has 3 operation modes: charge mode, boost mode and high-impedance (HZ) mode. In charge mode, the input current limit Q1 is enabled and Q2 and Q3 operate as a buck converter to charge battery. In boost mode, Q2 and Q3 operate as boost converter to step battery voltage up to +5V at VOUT, and the current limit switch Q1 is turned off, and the reverse current from VOUT to VIN is blocked. In HZ mode, all the switches are turned off and the drainage current from battery is very low. ACT2801 system

operation flow chart as shown in Figure 1, and ACT2801B system operation flow chart as shown in Figure 2.

Any transitions between boost mode and charge mode go through HZ mode by turning off all the switches Q1-Q3 into HZ mode for 2 seconds before enabling the other mode.

The modes are determined by HZ pin and VIN pin as shown in the table 1. A valid VIN voltage forces ACT2801/ACT2801B/ACT2801C into charge mode. Boost mode is enabled if HZ pin is pulled low and VIN is invalid or not present. For ACT2801/ACT2801B, when HZ=0, if PB is pulled low for more than 30ms, boost converter is enabled. For ACT2801, during boost on, if PB is pressed more than 1.5s, boost converter will be off.

Table 1: Mode Selection

| HZ PIN    | 0     | 0      | 1  | 1      |
|-----------|-------|--------|----|--------|
| VIN Valid | 0     | 1      | 0  | 1      |
| Mode      | Boost | Charge | HZ | Charge |

### Flashlight

ACT2801B has an flashlight function. Once PB is pressed for 3 seconds, the flashlight is switched on. The driver will deliver up to 50mA current to the flashlight. During flashlight on, if PB is pressed for 3 seconds, flashlight will be switched off.

**Figure 1:**  
**ACT2801 System Operation Flow Chart**

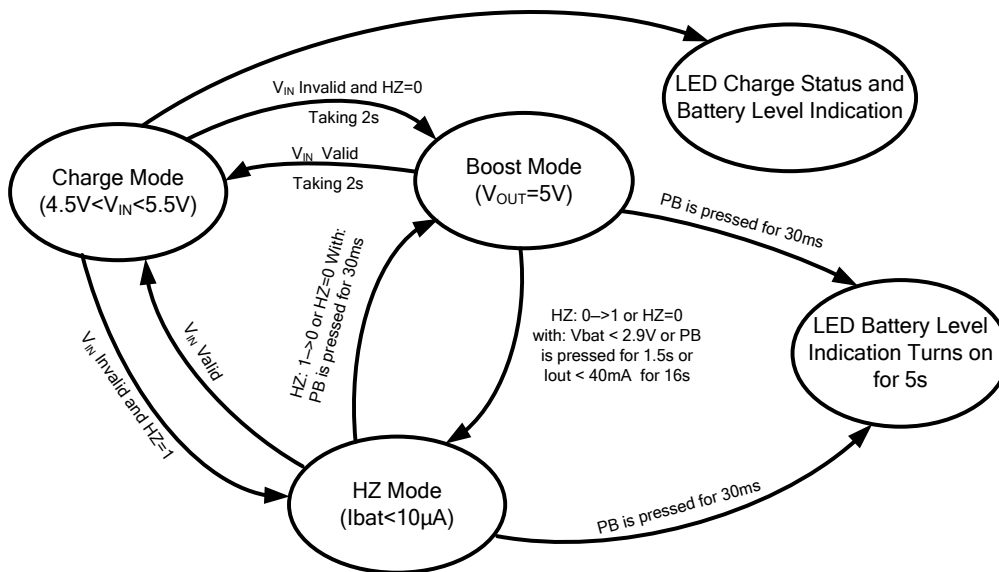

## FUNCTIONAL DESCRIPTION

**Figure 2:**  
**ACT2801B/ACT2801C System Operation Flow Chart**

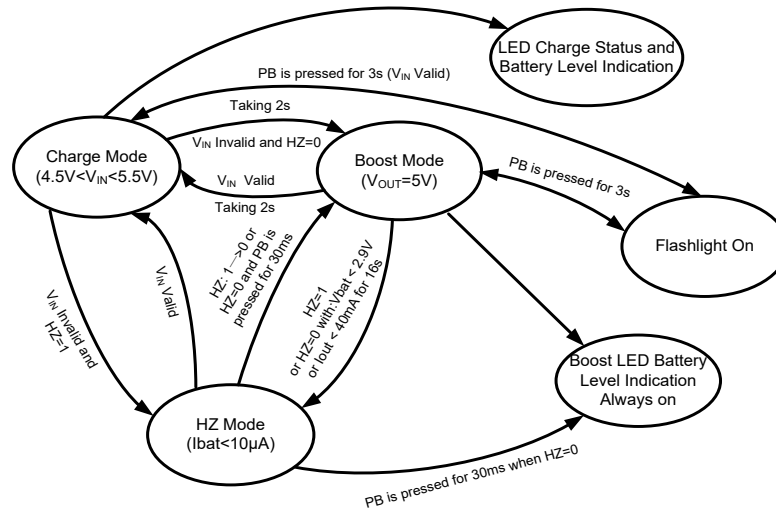

### Latch-Off

ACT2801/ACT2801B has latch off function. If the IC is in boost mode and the battery voltage drops below the Boost Mode Input Voltage UVLO voltage (typ 3.3V) minus Boost Mode Input Voltage UVLO Hysteresis (typ 400mV), the IC latches into HZ Mode. This safety feature prevents excessive battery discharge. The IC only exits this mode when input power is recycled.

### Input Current Limit

When the input current reaches the programmed value, switch Q1 goes into linear mode and output voltage starts to drop. When output voltage drops to 4.25V, hiccup mode is triggered and switch Q1 turns off and restart in 2 seconds.

### Switching Battery Charger

ACT2801/ACT2801B is configured in charge mode (buck mode) when  $V_{IN}$  is valid. In this mode, a battery is charged with preconditioning, fast charge, top-off and end of charge (EOC). The typical charge management is shown in Figure 3 and Figure 4.

### CC/CV Regulation Loop

There are CC/CV regulation loops built in ACT2801/ACT2801B, which regulates either current or voltage as necessary to ensure fast and safe charging of the battery. In a normal charge cycle, this loop regulates the current to the value set by the external resistor at the ICST pin. Charging continues at this current until the battery cell voltage reaches the termination voltage. At this point the CV loop takes over, and charge current is allowed to decrease as necessary to maintain charging at the termination voltage.

### Precondition Charge

A new charging cycle begins with the precondition state, and operation continues in this state until  $V_{BAT}$  exceeds the precondition threshold voltage. When operating in precondition state, the cell is charged at a reduced current, 10% of the programmed maximum fast charge constant current. Once  $V_{BAT}$  reaches the precondition threshold voltage the state machine jumps to the fast charge state.

### Fast Charge

If battery voltage is above preconditioning threshold, buck converter charges battery with constant current. In fast charge state, the ACT2801/ACT2801B charges at the current set by the external resistor connected at the ICST pin. During a normal charge cycle fast charge continues in CC mode until  $V_{BAT}$  reaches the charge termination voltage, at which point the ACT2801/ACT2801B charges in top off state.

### Top Off

With the battery voltage approaches the EOC voltage set by the BTV pin. Charge current decreases as charging continues. In the top off state, the cell is charged in constant voltage (CV) mode. During a normal charging cycle charging proceeds until the charge current decreases below the end of charge (EOC) threshold, defined as 13% of fast charge current. When this happens, the state machine terminates the charge cycle and jumps to the EOC state.

**FUNCTIONAL DESCRIPTION**

**End of Charge**

When charges current decreases to 13% of set fast charge current, the buck converter goes into end of charge mode and keep monitoring the battery voltage.

**Recharge**

When battery voltage drops by 200mV below the end of charge voltage, the charger is reinitiated with constant current charge.

**Figure 3.**  
**Typical Li+ Charge Profile and ACT2801/ACT2801B/ACT2801C Charge States**

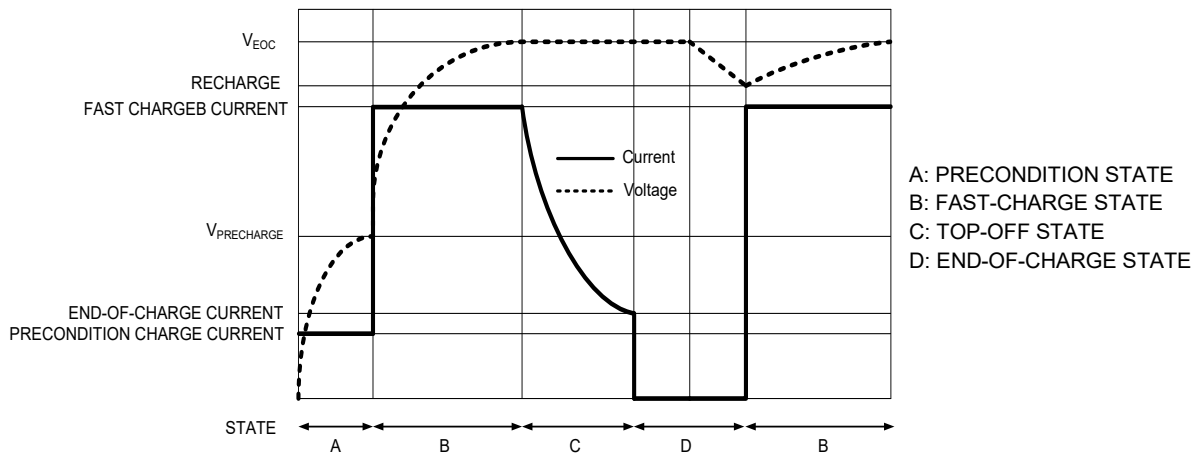

**Figure 4.**  
**Charger State Diagram**

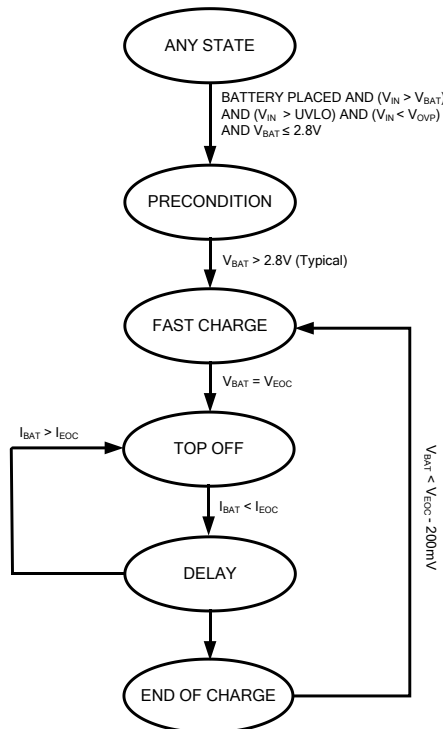

## APPLICATIONS INFORMATION

### Battery Charge Termination Voltage

Battery charge termination voltage is set by a resistor  $R_{btv}$  connected from BTV pin to AGND as shown in Figure 5. The battery charge termination voltage is estimated as the following equation:

$$V_{BAT}(V) = 4.1(V) + R_{btv} \times 4 \times 10^{-6}(V) \quad (1)$$

$R_{btv}$  is selected based on the battery voltage rating. 1% accuracy resistor is recommended for  $R_{btv}$ .

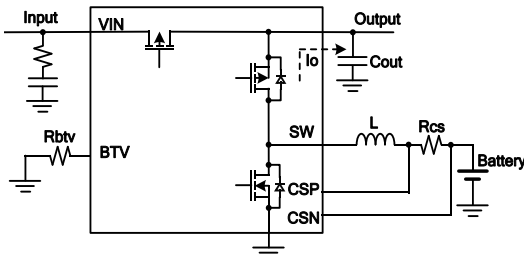

Figure 5. Battery terminal voltage setting circuit

### LED Status Indication

4 LEDs ON/OFF and flash show the charge status and the remained capacity level as shown in the table 2. The LED status is based on battery voltage and operation modes. When battery voltage is low, LED1 is flashing. In charge mode, when a battery is fully charged, flashing stops and all the 4 LEDs are solid on.

### Battery level voltage shift (BLVS pin)

LED1-4 voltage thresholds are adjusted from HZ mode during charging and discharging based on

the compensated impedance. Those thresholds are programmed by a resistor connected from BLVS pin to AGND as shown in Figure 6. The following equation shows the LED4 voltage threshold:

$$V_{BATLED4}(V) = 3.5(V) + 0.01(mA) \times R_{BLVS}(k\Omega) \quad (2)$$

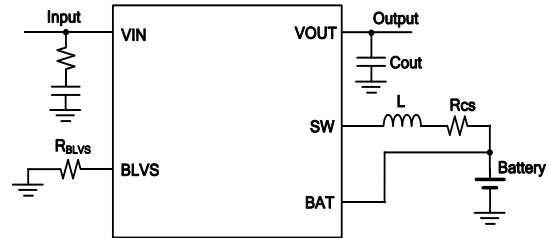

Figure 6. Battery level voltage shift setting circuit

As long as LED4 is set, all the other 3 LED thresholds is fixed as shown in the table 3:

| $R_{BLVS}$ (ohm) | 50K   | 60K   | 70K   | 80K   |
|------------------|-------|-------|-------|-------|
| LED1             | 3.35V | 3.45V | 3.55V | 3.65V |
| LED2             | 3.60V | 3.70V | 3.80V | 3.90V |
| LED3             | 3.75V | 3.85V | 3.95V | 4.05V |
| LED4             | 4.00V | 4.10V | 4.20V | 4.30V |

### Input Current Limit

An external resistor is used to set the input current limit connected from ILIM pin to AGND as shown in Figure 7. Input current limit has built-in soft startup and current foldback control loop. The input current limit is estimated as the following equation:

$$I_{ILIM}(A) = \frac{2.4(V)}{R_{ILIM}(k\Omega)} \quad (3)$$

Table2: LED Indication

| LED                                 | Charge Mode |       |       |       | (Boost or HZ Mode)<br>ACT2801QL-T1028 / ACT2801CQL-T1028 :PB time > 30ms |      |      |      |
|-------------------------------------|-------------|-------|-------|-------|--|------|------|------|
|                                     | LED1        | LED2  | LED3  | LED4  | LED1   | LED2 | LED3 | LED4 |
| $V_{BAT} < 2.9V$                    | Flash       | Off   | Off   | Off   | Off  | Off  | Off  | Off  |
| $2.9V \leq V_{BAT} < LED1$          | Flash       | Off   | Off   | Off   | Flash  | Off  | Off  | Off  |
| $LED1 \leq V_{BAT} < LED2$          | On          | Flash | Off   | Off   | On   | Off  | Off  | Off  |
| $LED2 \leq V_{BAT} < LED3$          | On          | On    | Flash | Off   | On   | On   | Off  | Off  |
| $LED3 \leq V_{BAT} < LED4$          | On          | On    | On    | Flash | On   | On   | On   | Off  |
| $V_{BAT} \geq LED4$                 | On          | On    | On    | Flash | On   | On   | On   | On   |
| $V_{BAT} \geq LED4$ (End of Charge) | On          | On    | On    | On    | On   | On   | On   | On   |

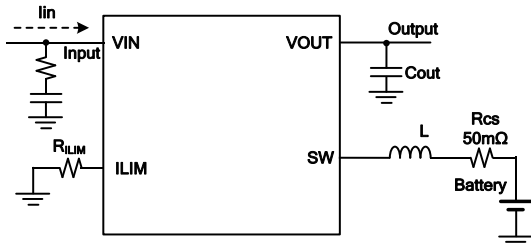

Figure 7. Input current limit setting circuit

Input current limit at various resistor curve is shown in Figure 8.

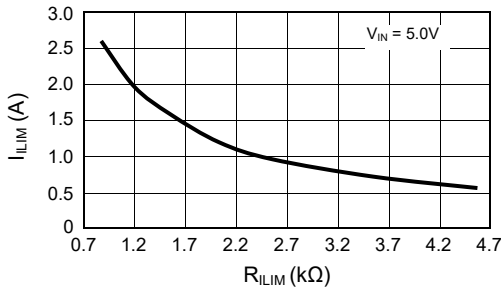

Figure 8. Input current limit setting

The ILIM pin voltage is proportional to input current until input current is limited, as shown in Figure 9.

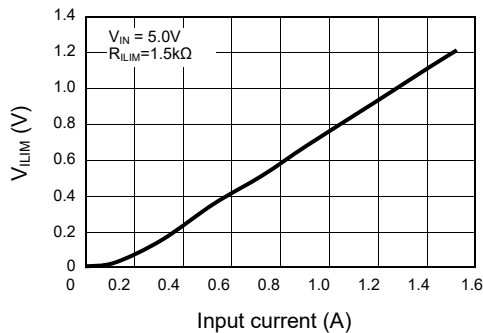

Figure 9. V\_ILIM VS. input current

In application, if fast charge current setting is higher than input current limit, must be parallel a 0.47uF capacitor with R\_ILIM as shown in Figure 10.

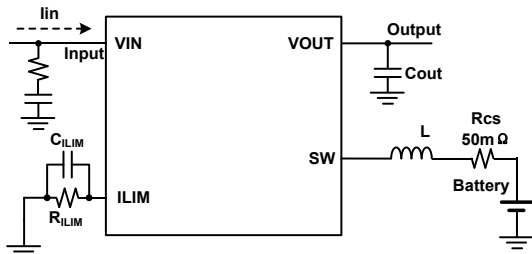

Figure 10. Input current limit smaller than fast charge current

### Battery Fast Charge Current

Battery fast charge current is set by a resistor connected from ICST pin to AGND as shown in

Figure 11. Figure 12 gives out different fast charge current with various R\_ICST. The battery fast charge current is estimated as the following equation:

$$I_c(A) = 1.25(A) \times \frac{R_{ICST}(k\Omega)}{R_{cs}(m\Omega)} \quad (4)$$

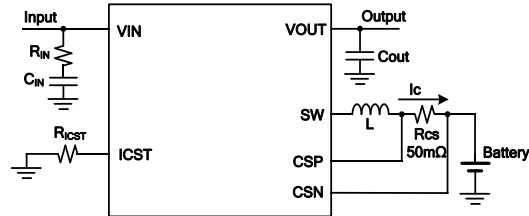

Figure 11. Battery fast charge current setting

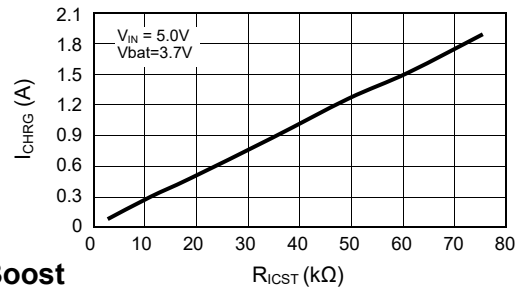

Figure 12. Battery fast charge current setting

### Boost

#### Output Constant Current

Boost output current is set by a resistor connected from IOST pin to AGND as shown in Figure 13. The boost output current is estimated as the following equation:

$$I_{IOST}(A) = \frac{2}{3}(A) \times \frac{R_{IOST}(k\Omega)}{R_{cs}(m\Omega)} \quad (5)$$

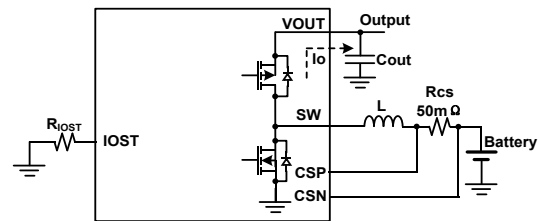

Figure 13. Boost output current setting circuit

Figure 14 gives out boost output current with various R\_IOST.

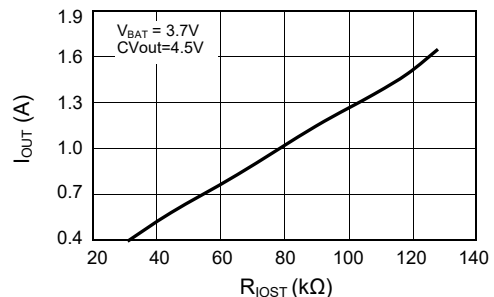

Figure 14. Boost output current setting

The IOST pin voltage is proportional to output current until output current is limited, as shown in Figure 15.

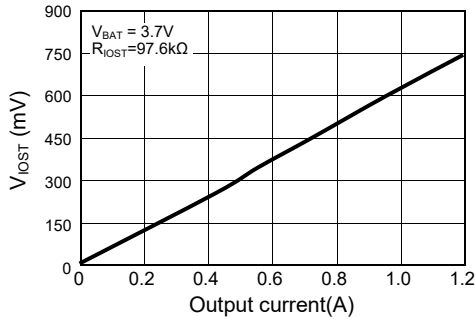

Figure 15.  $V_{IST}$  VS. output current

### Battery Impedance Compensation

An external resistor is used to set the impedance from 40mΩ to 500mΩ as shown in Figure 16. R<sub>IMC</sub> is corresponding to battery impedance. Higher R<sub>IMC</sub> gives higher compensation voltage which is positively proportional to battery charge/discharge current.

Select R<sub>IMC</sub> based on battery impedance:

$$R_{IMC}(k\Omega) = \frac{25 \times R(m\Omega)}{R_{cs}(m\Omega)} \quad (6)$$

$$V_{BAT}(V) = BAT(V) - I_{BAT}(A) \times R(m\Omega) \times 10^{-3} \quad (7)$$

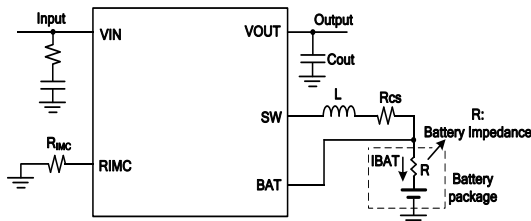

Figure 16. Battery impedance compensation setting circuit

The battery impedance as shown in the table 4 according to the R<sub>IMC</sub> and R<sub>CS</sub>:

Table 4: Battery Impedance

| R <sub>IMC</sub> (KΩ)   |                       | 50  | 100 | 200 |
|-------------------------|-----------------------|-----|-----|-----|
| Battery Impedance R(mΩ) | R <sub>CS</sub> =25mΩ | 50  | 100 | 200 |
|                         | R <sub>CS</sub> =50mΩ | 100 | 200 | 400 |

### Input Over Voltage Surge

In the case of pure ceramic input capacitor is chosen, if the input cable is long, stray inductance may cause over voltage spikes as twice as the steady-state voltage when input source is plugged in. Below input circuit is recommended to avoid input voltage surge. R1 resistor is added in series with capacitor C1 to damp the potential LC resonance as shown in Figure 17.

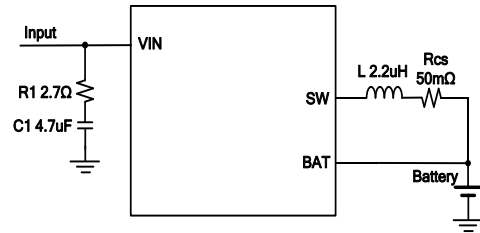

Figure 17. Input over voltage surge protection circuit

### Boost Output Plug-in Auto Detection

Figure 18 provides a solution for auto plug-in detection.

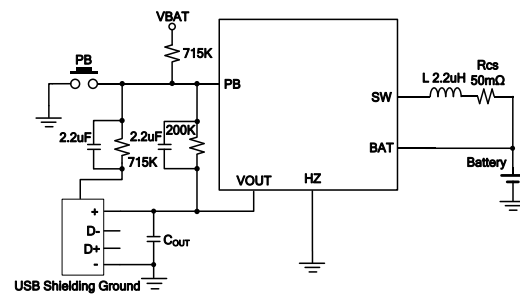

Figure 18. Boost output auto detection circuit

### External Input Over Voltage Protection

Considering the maximum voltage rating at VIN pin, the external OVP circuit as shown in Figure 19 is recommended if input voltage may go higher than 7V. With the enhanced OVP circuit, the design can pass UN38.3.

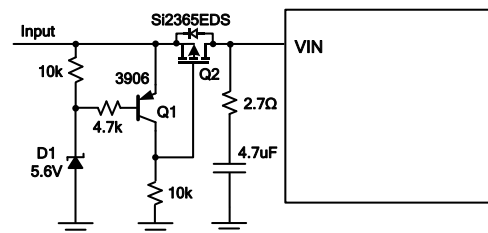

Figure 19. Input over voltage protection

### Inductor and Capacitor Selection

ACT2801/ACT2801B/ACT2801C supports SMD components. 2.2μH inductor is recommended. Input side, 4.7μF ceramic capacitor in series with 2.7Ω resistor are recommended, on battery side, 2\*22μF ceramic capacitors is recommended while on output side, 2\*22μF ceramic capacitors are recommended.

### Battery Temperature Monitoring

ACT2801 continuously monitors the temperature of the battery pack by sensing the resistance of its thermistor, and suspends charging if the temperature of the battery pack exceeds the safety

limits.

In a typical application, the TH pin is connected to the battery pack's thermistor input as shown in Figure 20. The ACT2801 injects a 60µA current out of the TH pin into the thermistor, so that the thermistor resistance is monitored by comparing the voltage at TH to the internal  $V_{THL}$  and  $V_{THH}$  thresholds of 0.3V and 1.5V, respectively. When  $V_{TH} > V_{THH}$  or  $V_{TH} < V_{THL}$  charging and the charge timers are suspended. When  $V_{TH}$  returns to the normal range, charging and the charge timers resume.

The threshold is given by:

$$60\mu\text{A} \times R_{\text{NOM}} \times k_{\text{HOT}} = 0.3\text{V} \rightarrow R_{\text{NOM}} \times k_{\text{HOT}} = 5\text{k}\Omega$$

$$60\mu\text{A} \times R_{\text{NOM}} \times k_{\text{COLD}} = 1.5\text{V} \rightarrow R_{\text{NOM}} \times k_{\text{COLD}} = 25\text{k}\Omega$$

where  $R_{\text{NOM}}$  is the nominal thermistor resistance at room temperature, and  $k_{\text{HOT}}$  and  $k_{\text{COLD}}$  are the ratios of the thermistor's resistance at the desired hot and cold thresholds, respectively.

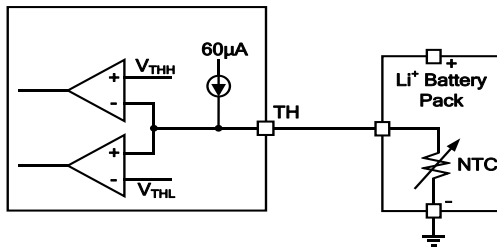

Figure 20. Battery thermal circuit



## PC Board Layout Guidance

When laying out the printed circuit board, the following checklist should be used to ensure proper operation of the IC.

1. Arrange the power components to reduce the AC loop size, VIN pin, Vout pin, SW pin and the schottky diode.
2. Place input decoupling ceramic capacitor C3 and R10 as close to VIN pin as possible. Resistor R10 is added in series with capacitor C3 to damp the potential LC resonance .
3. Use copper plane for power GND for best heat dissipation and noise immunity.
4. Place CSP and CSN capacitor C6 (10nF) close to CSP and CSN pin as possible, use Kevin Sense from sense resistor R2 and R2A to CSP and CSN pins. 22uF decoupling capacitor is added close to BAT pin.
5. Place the ceramic capacitor C2 and D1 as close to VOUT and PGND as possible, SW goes under the C2 (recommnd C2 to use 1206 size). SW pad is a noisy node switching. It should be isolated away from the rest of circuit for good EMI and low noise operation.
6. Thermal pad is connected to GND layer through vias (recommend 4X4 pins and the aperture is 10mil). Ground plane, PGND and AGND is single point connected under the ACT2801/ACT2801B/ACT2801C thermal pad through vias to limited SW area.
7. From BAT pin to the Battery positive terminal, need to lay the divided line to ensure the battery voltage accuracy of sampling.
8. RC snubber is recommended to add across SW to PGND to reduce SW spike below 7V. 2A /20V schottky is added to across V<sub>OUT</sub> and SW pins.

A demo board PCB layout example is shown in the figure 21.

**Figure 21.**  
PCB Layout

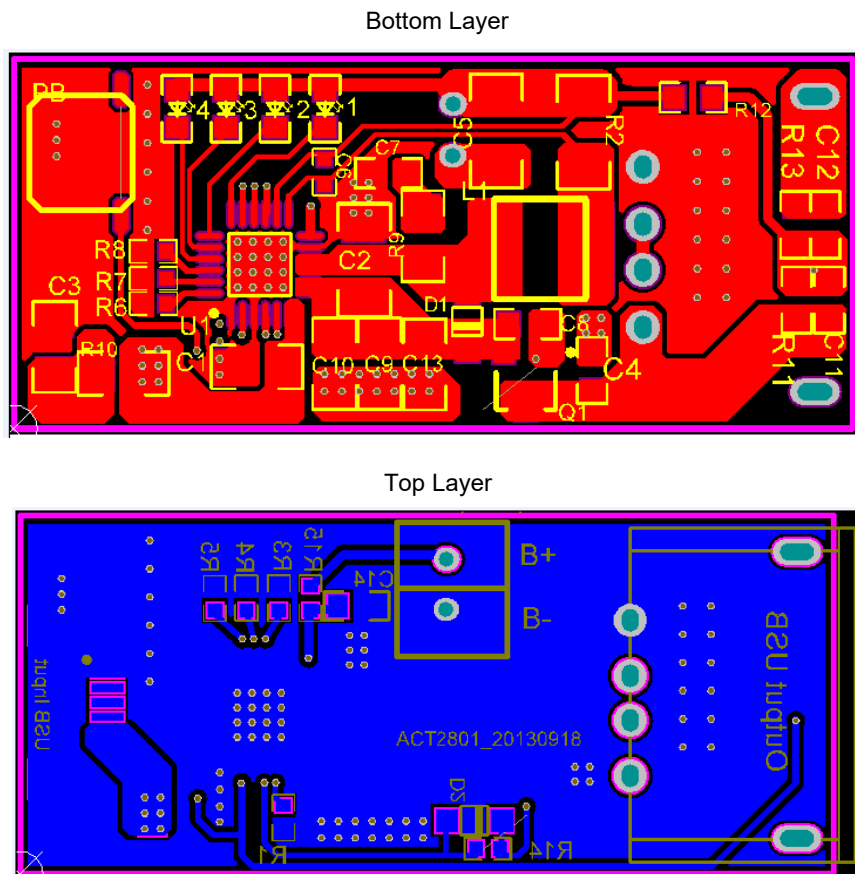

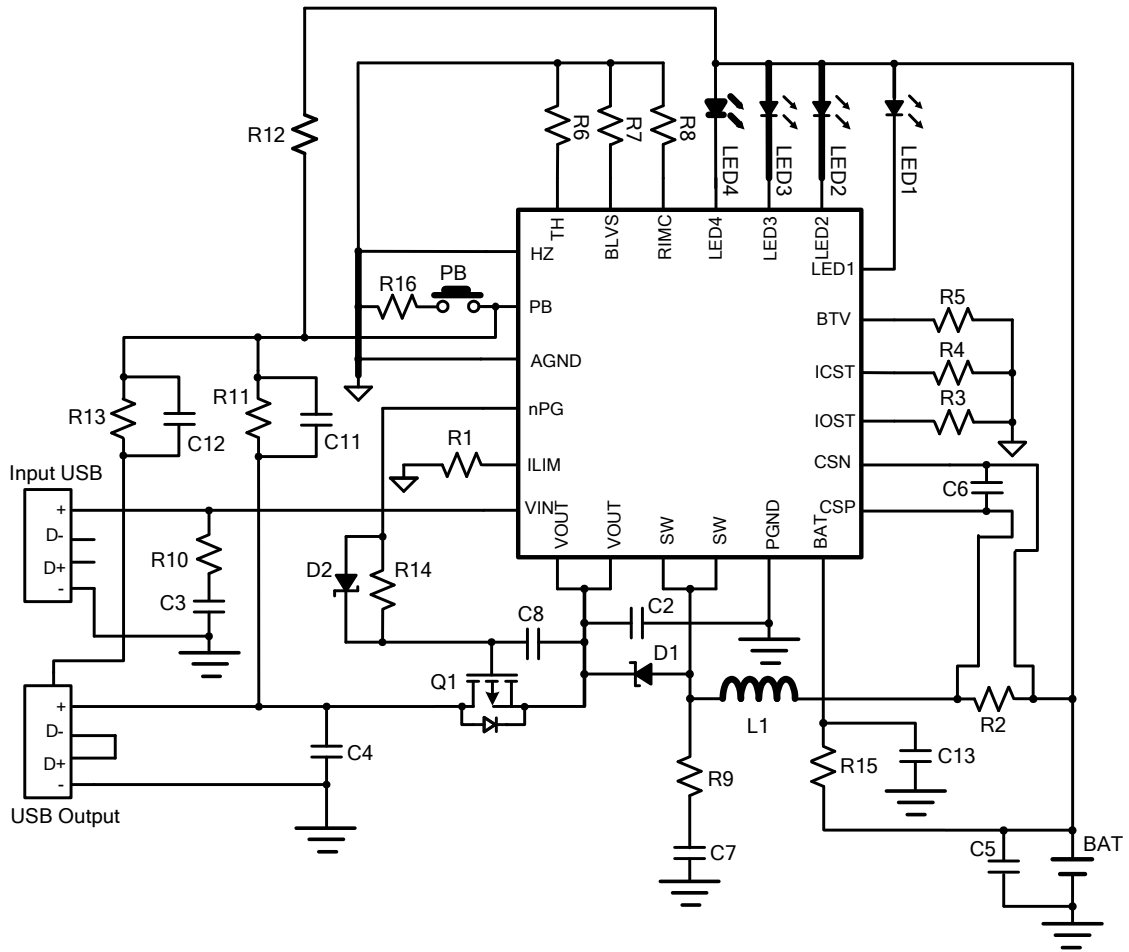

Figure 22. ACT2801 typical application circuit  
(Input current limit 2.0A, fast charge current limit 1.5A, boost output constant current limit 1.3A)

**Table 5: BOM List**

| ITEM | REFERENCE            | DESCRIPTION   | QTY | MANUFACTURER |
|------|----------------------|---|-----|--------------|
| 1    | L1                   | SWPA4020S1R0NT 2.2uH 3.4A (4*4*2mm)                             | 1   | Sunlord      |
| 2    | Q1                   | SI2333DDS, R <sub>dson</sub> =28mΩ at V <sub>GS</sub> = - 4.5 V | 1   | Vishay       |
| 3    | D1                   | MBR1020VL, 20V/1A, Schottky                                     | 1   | Panjit       |
| 4    | D2                   | 1N4148, V <sub>f</sub> =0.7V, 75V Schottky                      | 1   | Murata/TDK   |
| 5    | C2,C5                | Ceramic Capacitor, 22uF/10V, X7R, 1206                          | 2   | Murata/TDK   |
| 6    | C3                   | Ceramic Capacitor, 4.7uF/10V, X7R, 1206                         | 1   | Murata/TDK   |
| 7    | C4                   | Ceramic Capacitor, 0.1uF/10V, X7R, 0603                         | 1   | Murata/TDK   |
| 8    | C6                   | Ceramic Capacitor, 10nF/10V, X7R, 0402                          | 1   | Murata/TDK   |
| 9    | C7                   | Ceramic Capacitor, 4.7nF/10V, X7R, 0603                         | 1   | Murata/TDK   |
| 10   | C8                   | Ceramic Capacitor, 1uF/10V, X7R, 0603                           | 1   | Murata/TDK   |
| 11   | C11,C12              | Ceramic Capacitor, 2.2uF/10V, X7R, 0603                         | 2   | Murata/TDK   |
| 12   | C13                  | Ceramic Capacitor, 4.7uF/10V, X7R, 0603                         | 1   | Murata/TDK   |
| 13   | R1                   | Chip Resistor, 1.2kΩ, 1/16W, 1%, 0402                           | 1   | Murata/TDK   |
| 14   | R2                   | Chip Resistor, 50mΩ, 1/2W, 1%, 1206                             | 1   | SART         |
| 15   | R3                   | Chip Resistor, 97.6kΩ, 1/16W, 1%, 0402                          | 1   | Murata/TDK   |
| 16   | R4                   | Chip Resistor, 60.4kΩ, 1/16W, 1%, 0402                          | 1   | Murata/TDK   |
| 17   | R5                   | Chip Resistor, 25kΩ, 1/16W, 1%, 0402                            | 1   | Murata/TDK   |
| 18   | R6                   | Chip Resistor, 10kΩ, 1/16W, 1%, 0402                            | 1   | Murata/TDK   |
| 19   | R7                   | Chip Resistor, 60kΩ, 1/16W, 1%, 0402                            | 1   | Murata/TDK   |
| 20   | R8                   | Chip Resistor, 100kΩ, 1/16W, 1%, 0402                           | 1   | Murata/TDK   |
| 21   | R9                   | Chip Resistor, 0.47Ω, 1/8W, 5%, 0805                            | 1   | Murata/TDK   |
| 22   | R10                  | Chip Resistor, 2.7Ω, 1/4W, 5%, 1206                             | 1   | Murata/TDK   |
| 23   | R11                  | Chip Resistor, 200kΩ, 1/10W, 5%, 0603                           | 1   | Murata/TDK   |
| 24   | R12,R13              | Chip Resistor, 715kΩ, 1/10W, 5%, 0603                           | 2   | Murata/TDK   |
| 25   | R14                  | Chip Resistor, 100kΩ, 1/10W, 5%, 0603                           | 1   | Murata/TDK   |
| 26   | R15                  | Chip Resistor, 2.2Ω, 1/10W, 5%, 0603                            | 1   | Murata/TDK   |
| 27   | R16                  | Chip Resistor, 100Ω, 1/10W, 5%, 0603                            | 1   | Murata/TDK   |
| 28   | LED1,LED2, LED3,LED4 | LED, 0603, Blue   | 4   | LED Manu     |
| 29   | PB                   | Push Button Switch  | 1   | Nikkai Omron |
| 30   | USB                  | 10.2*14.6*7mm, 4P   | 1   |              |
| 31   | Micro-USB            | MICRO USB 5P/F SMT B  | 1   |              |
| 32   | U1                   | IC, ACT2801QL-T1028, T-QFN 44-24                                | 1   | ACT          |

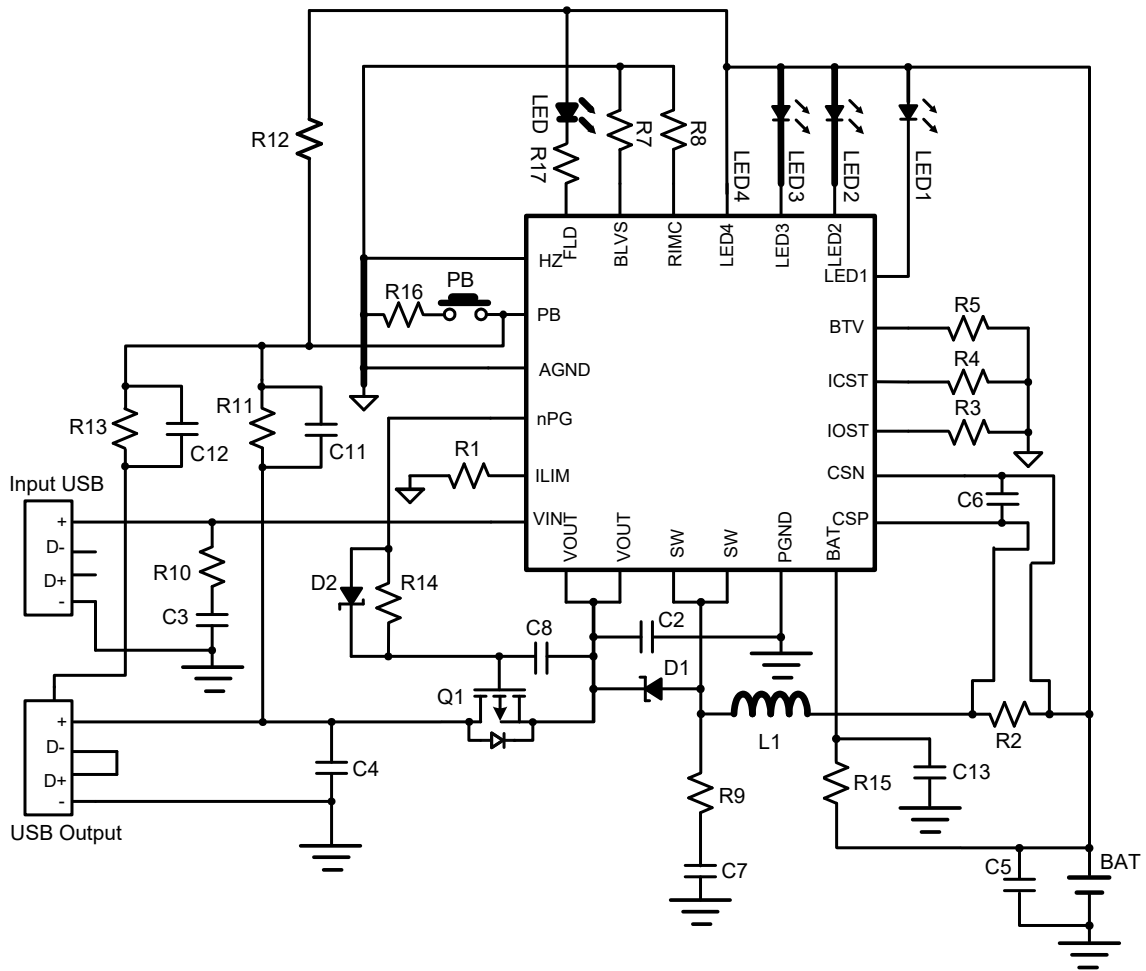

Figure 23. ACT2801B/ACT2801C typical application circuit  
(Input current limit 2.0A, fast charge current limit 1.5A, boost output constant current limit 1.3A)

**Table 6: BOM List**

| ITEM | REFERENCE            | DESCRIPTION   | QTY | MANUFACTURER |
|------|----------------------|---|-----|--------------|
| 1    | L1                   | SWPA4020S1R0NT 2.2uH 3.4A (4*4*2mm)                             | 1   | Sunlord      |
| 2    | Q1                   | SI2333DDS, R <sub>dson</sub> =28mΩ at V <sub>GS</sub> = - 4.5 V | 1   | Vishay       |
| 3    | D1                   | MBR1020VL, 20V/1A, Schottky                                     | 1   | Panjit       |
| 4    | D2                   | 1N4148, V <sub>f</sub> =0.7V, 75V Schottky                      | 1   | Murata/TDK   |
| 5    | C2,C5                | Ceramic Capacitor, 22uF/10V, X7R, 1206                          | 2   | Murata/TDK   |
| 6    | C3                   | Ceramic Capacitor, 4.7uF/10V, X7R, 1206                         | 1   | Murata/TDK   |
| 7    | C4                   | Ceramic Capacitor, 0.1uF/10V, X7R, 0603                         | 1   | Murata/TDK   |
| 8    | C6                   | Ceramic Capacitor, 10nF/10V, X7R, 0402                          | 1   | Murata/TDK   |
| 9    | C7                   | Ceramic Capacitor, 4.7nF/10V, X7R, 0603                         | 1   | Murata/TDK   |
| 10   | C8                   | Ceramic Capacitor, 1uF/10V, X7R, 0603                           | 1   | Murata/TDK   |
| 11   | C11,C12              | Ceramic Capacitor, 2.2uF/10V, X7R, 0603                         | 2   | Murata/TDK   |
| 12   | C13                  | Ceramic Capacitor, 4.7uF/10V, X7R, 0603                         | 1   | Murata/TDK   |
| 13   | R1                   | Chip Resistor, 1.2kΩ, 1/16W, 1%, 0402                           | 1   | Murata/TDK   |
| 14   | R2                   | Chip Resistor, 50mΩ, 1/2W, 1%, 1206                             | 1   | SART         |
| 15   | R3                   | Chip Resistor, 97.6kΩ, 1/16W, 1%, 0402                          | 1   | Murata/TDK   |
| 16   | R4                   | Chip Resistor, 60.4kΩ, 1/16W, 1%, 0402                          | 1   | Murata/TDK   |
| 17   | R5                   | Chip Resistor, 25kΩ, 1/16W, 1%, 0402                            | 1   | Murata/TDK   |
| 18   | R7                   | Chip Resistor, 60kΩ, 1/16W, 1%, 0402                            | 1   | Murata/TDK   |
| 19   | R8                   | Chip Resistor, 100kΩ, 1/16W, 1%, 0402                           | 1   | Murata/TDK   |
| 20   | R9                   | Chip Resistor, 0.47Ω, 1/8W, 5%, 0805                            | 1   | Murata/TDK   |
| 21   | R10                  | Chip Resistor, 2.7Ω, 1/4W, 5%, 1206                             | 1   | Murata/TDK   |
| 22   | R11                  | Chip Resistor, 200kΩ, 1/10W, 5%, 0603                           | 1   | Murata/TDK   |
| 23   | R12,R13              | Chip Resistor, 715kΩ, 1/10W, 5%, 0603                           | 2   | Murata/TDK   |
| 24   | R14                  | Chip Resistor, 100kΩ, 1/10W, 5%, 0603                           | 1   | Murata/TDK   |
| 25   | R15                  | Chip Resistor, 2.2Ω, 1/10W, 5%, 0603                            | 1   | Murata/TDK   |
| 26   | R16                  | Chip Resistor, 100Ω, 1/10W, 5%, 0603                            | 1   | Murata/TDK   |
| 27   | R17                  | Chip Resistor, 51Ω, 1/8W, 5%, 0805                              | 1   | Murata/TDK   |
| 28   | LED1,LED2, LED3,LED4 | LED, 0603, Blue   | 4   | LED Manu     |
| 29   | LED                  | Flashlight  | 1   | LED Manu     |
| 30   | PB                   | Push Button Switch  | 1   | Nikkai Omron |
| 31   | USB                  | 10.2*14.6*7mm, 4P   | 1   |              |
| 32   | Micro-USB            | MICRO USB 5P/F SMT B  | 1   |              |
| 33   | U1                   | IC, ACT2801B/ACT2801C, T-QFN 44-24                              | 1   | ACT          |

**TYPICAL PERFORMANCE CHARACTERISTICS CONT'D**

(Schematic as show in Figure 22, Ta = 25°C, unless otherwise specified)

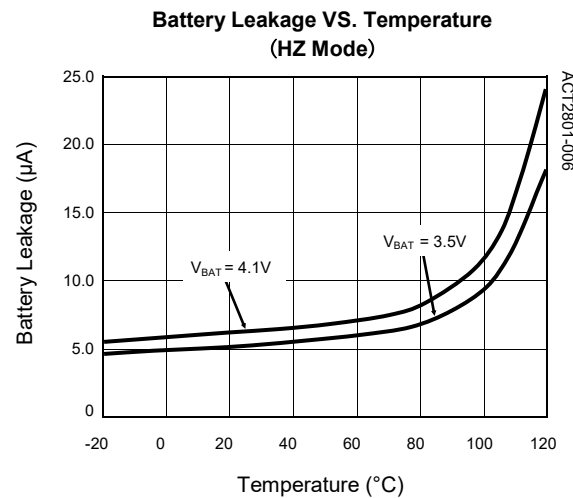
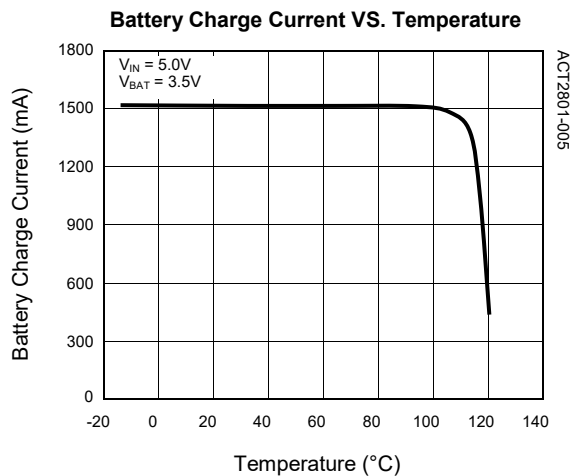
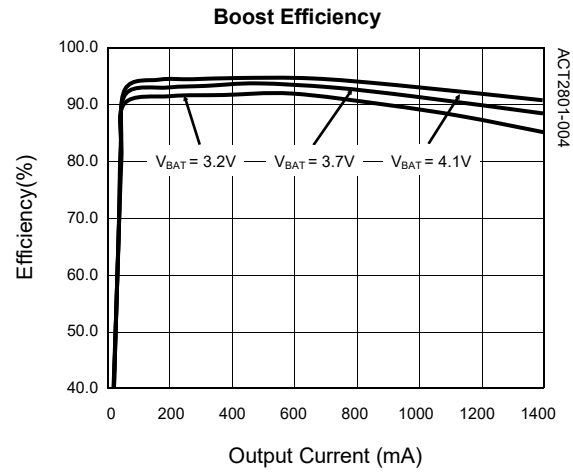
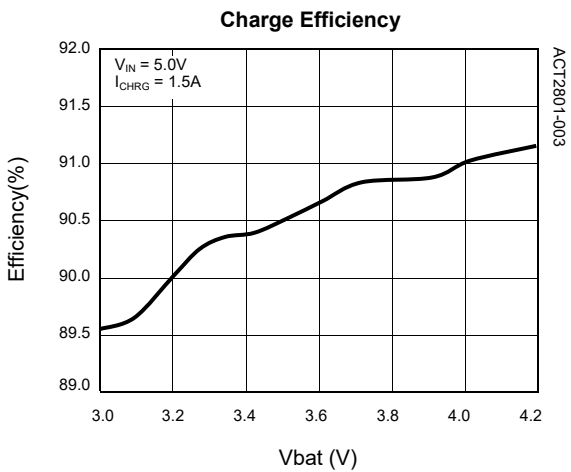
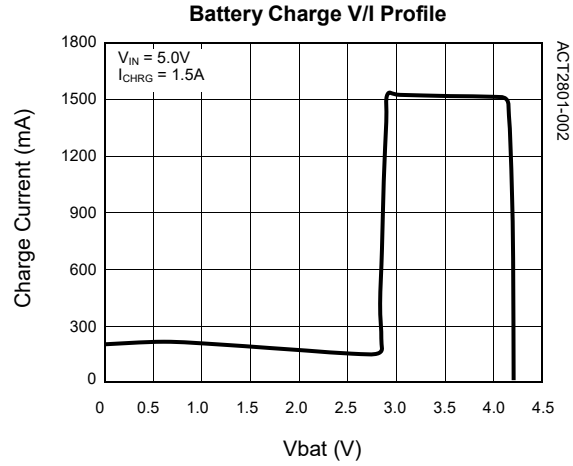
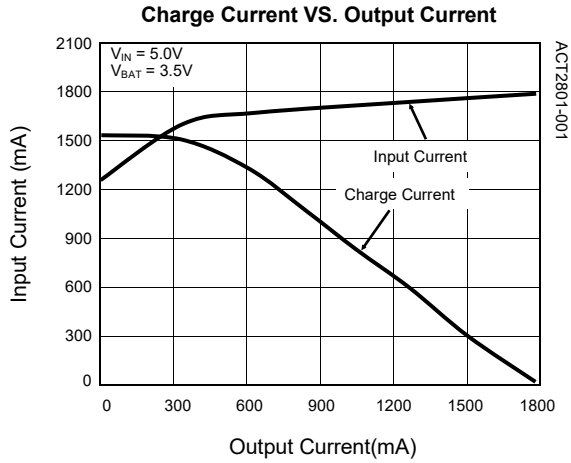

**TYPICAL PERFORMANCE CHARACTERISTICS CONT'D**

(Schematic as show in Figure 22, Ta = 25°C, unless otherwise specified)

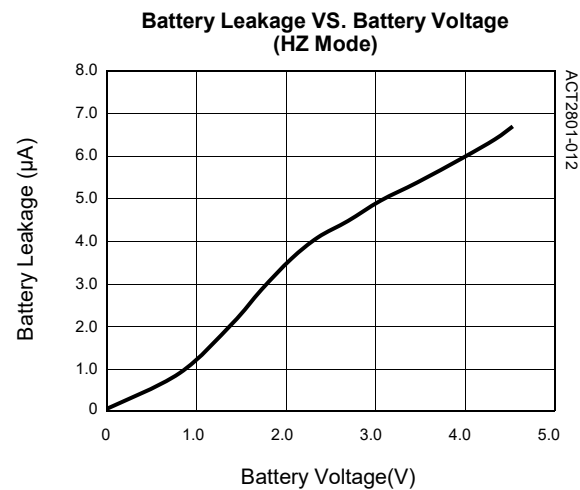
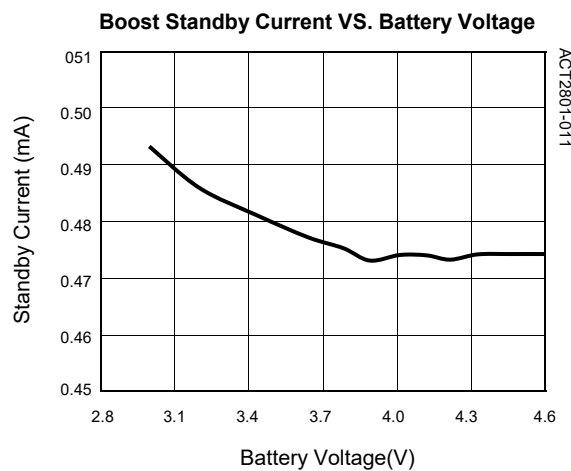
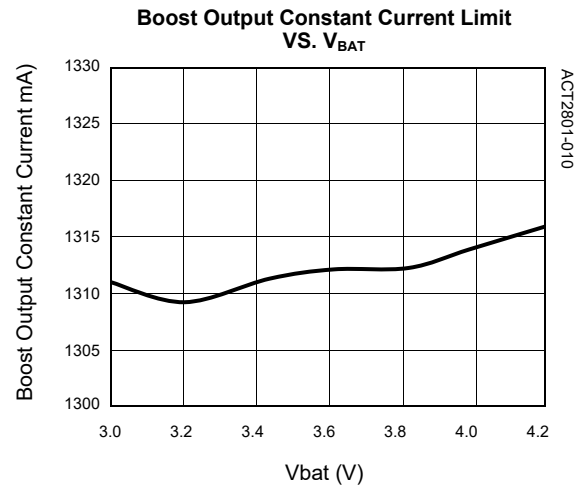
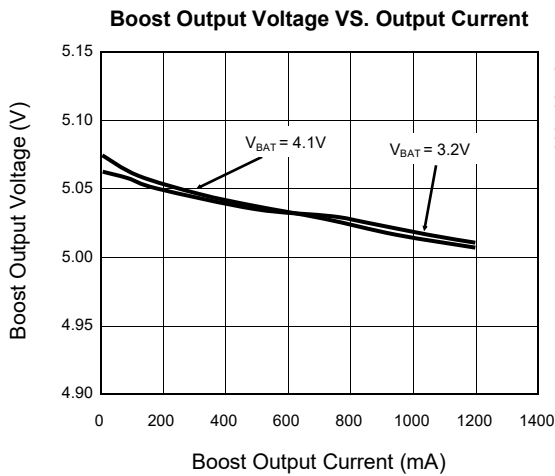
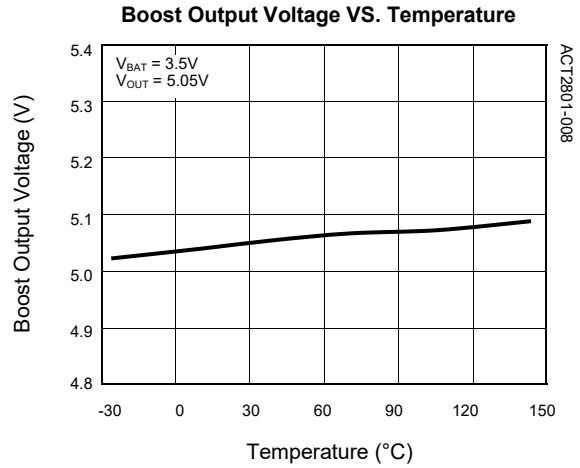
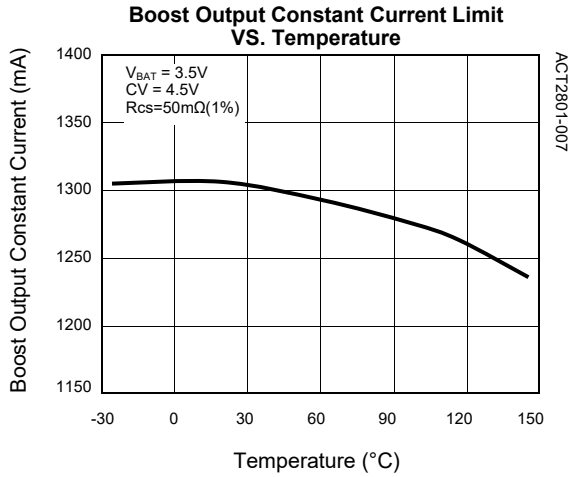

**TYPICAL PERFORMANCE CHARACTERISTICS CONT'D**

(Schematic as show in Figure 22, Ta = 25°C, unless otherwise specified)

**Boost Load Transient (80mA-1A-80mA)**

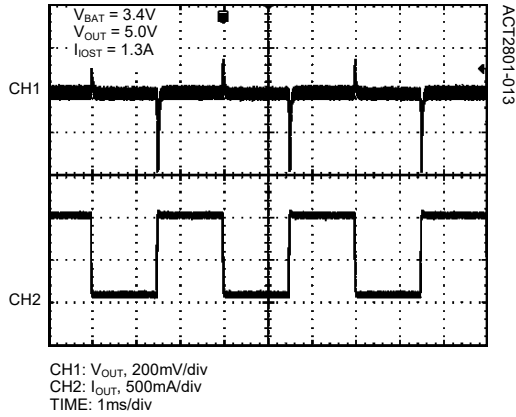

**Boost Load Transient (80mA-1A-80mA)**

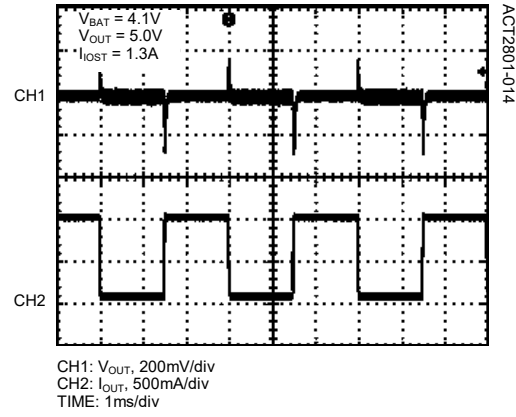

**SW and Output Waveforms in Boost Mode**

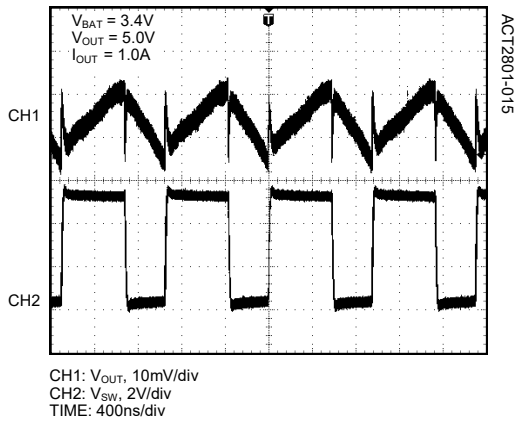

**SW and Output Waveforms in Boost Mode**

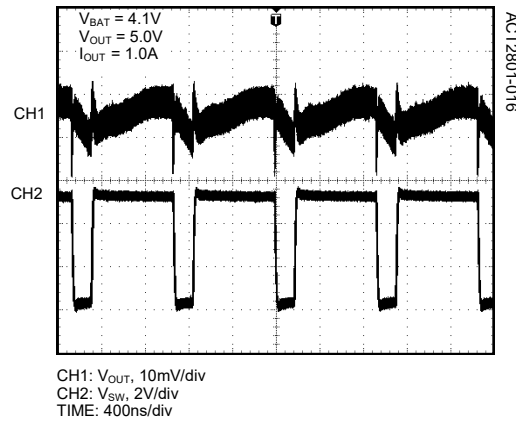

**Transition Between Buck Mode and Boost Mode**

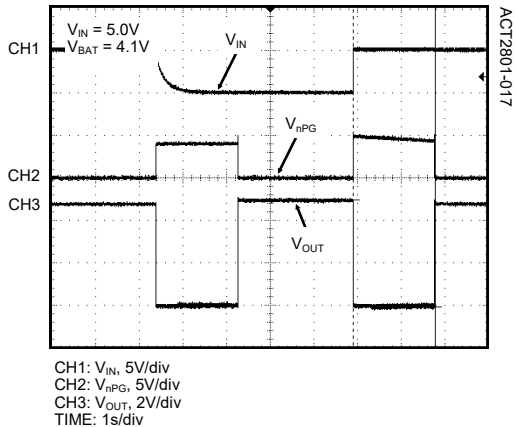



## PACKAGE OUTLINE

### QFN44-24 PACKAGE OUTLINE AND DIMENSIONS

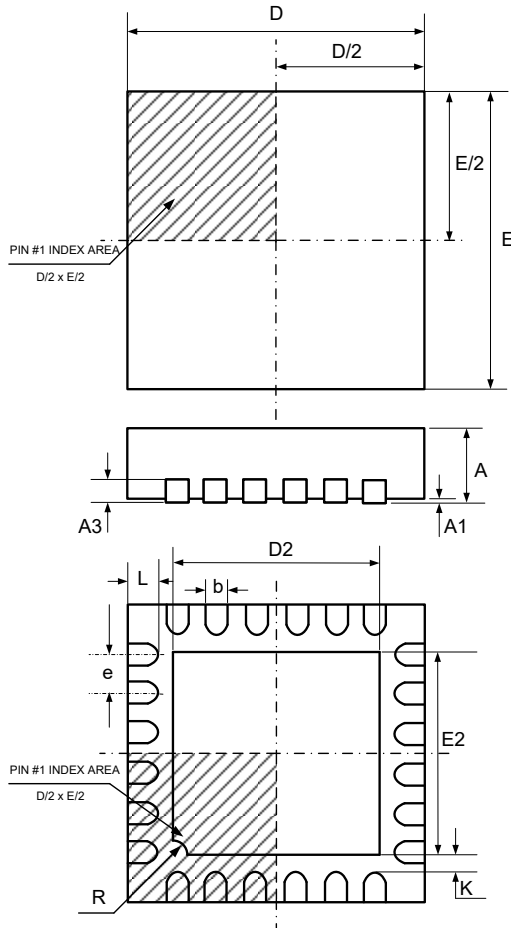

| SYMBOL | DIMENSION IN MILLIMETERS |       | DIMENSION IN INCHES |       |
|--------|--------------------------|-------|---------------------|-------|
|        | MIN                      | MAX   | MIN                 | MAX   |
| A      | 0.800                    | 1.000 | 0.032               | 0.040 |
| A1     | 0.000                    | 0.050 | 0.000               | 0.002 |
| A3     | 0.200 REF                |       | 0.008 REF           |       |
| b      | 0.180                    | 0.300 | 0.007               | 0.012 |
| D      | 4.000 BSC                |       | 0.160 BSC           |       |
| E      | 4.000 BSC                |       | 0.160 BSC           |       |
| D2     | 2.500                    | 2.800 | 0.098               | 0.110 |
| E2     | 2.500                    | 2.800 | 0.098               | 0.110 |
| e      | 0.500 BSC                |       | 0.020 BSC           |       |
| L      | 0.350                    | 0.450 | 0.014               | 0.018 |
| R      | 0.200 TYP                |       | 0.008 TYP           |       |
| K      | 0.200                    | ---   | 0.008               | ---   |

Active-Semi, Inc. reserves the right to modify the circuitry or specifications without notice. Users should evaluate each product to make sure that it is suitable for their applications. Active-Semi products are not intended or authorized for use as critical components in life-support devices or systems. Active-Semi, Inc. does not assume any liability arising out of the use of any product or circuit described in this datasheet, nor does it convey any patent license.

Active-Semi and its logo are trademarks of Active-Semi, Inc. For more information on this and other products, contact [sales@active-semi.com](mailto:sales@active-semi.com) or visit <http://www.active-semi.com>.

 active-semi<sup>®</sup> is a registered trademark of Active-Semi.



## Стандарт Электрон Связь

Мы молодая и активно развивающаяся компания в области поставок электронных компонентов. Мы поставляем электронные компоненты отечественного и импортного производства напрямую от производителей и с крупнейших складов мира.

Благодаря сотрудничеству с мировыми поставщиками мы осуществляем комплексные и плановые поставки широчайшего спектра электронных компонентов.

Собственная эффективная логистика и склад в обеспечивает надежную поставку продукции в точно указанные сроки по всей России.

Мы осуществляем техническую поддержку нашим клиентам и предпродажную проверку качества продукции. На все поставляемые продукты мы предоставляем гарантию .

Осуществляем поставки продукции под контролем ВП МО РФ на предприятия военно-промышленного комплекса России , а также работаем в рамках 275 ФЗ с открытием отдельных счетов в уполномоченном банке. Система менеджмента качества компании соответствует требованиям ГОСТ ISO 9001.

Минимальные сроки поставки, гибкие цены, неограниченный ассортимент и индивидуальный подход к клиентам являются основой для выстраивания долгосрочного и эффективного сотрудничества с предприятиями радиоэлектронной промышленности, предприятиями ВПК и научно-исследовательскими институтами России.

С нами вы становитесь еще успешнее!

### Наши контакты:

**Телефон:** +7 812 627 14 35

**Электронная почта:** [sales@st-electron.ru](mailto:sales@st-electron.ru)

**Адрес:** 198099, Санкт-Петербург,  
Промышленная ул, дом № 19, литера Н,  
помещение 100-Н Офис 331