



- Very low supply current per operator - essentially independent of supply voltage
- Low input bias current: 20 nA (temperature compensated)
- Low input offset voltage: 2 mV
- Low input offset current: 2 nA
- Input common mode voltage range includes ground
- Differential input voltage range equal to the power supply voltage
- Large output voltage swing 0 V to ( $V_{CC}^+$ ) - 1.5 V

### Description

The LM158W, LM258W, and LM358W circuits consist of two independent, high-gain, operational amplifiers (op-amps), which employ an internal frequency compensation and are specifically designed to operate from a single power supply over a wide range of voltages. The low-power supply drain is independent of the power supply voltage magnitude. Application areas include transducer amplifiers, DC gain blocks, and all the conventional op-amp circuits, which can now be more easily implemented in single power supply systems. For example, these circuits can be directly supplied with the standard +5 V, which is used in logic systems and easily provide the required interface electronics with no additional power supply. In linear mode, the input common mode voltage range includes ground. The output voltage can also swing to ground, even though operated from a single power supply voltage.

### Features

- ESD internal protection: 2 kV
- Internal frequency compensation implemented
- Large DC voltage gain: 100 dB
- Wide bandwidth (unity gain): 1.1 MHz (temperature compensated)

---

# Contents

<b>1</b>	<b>Schematic diagram</b> .....	<b>3</b>
<b>2</b>	<b>Absolute maximum ratings and operating conditions</b> .....	<b>4</b>
<b>3</b>	<b>Electrical characteristics</b> .....	<b>6</b>
<b>4</b>	<b>Typical applications</b> .....	<b>11</b>
<b>5</b>	<b>Package information</b> .....	<b>13</b>
5.1	SO8 package information .....	14
5.2	MiniSO8 package information .....	15
5.3	TSSOP8 package information .....	16
<b>6</b>	<b>Ordering information</b> .....	<b>17</b>
<b>7</b>	<b>Revision history</b> .....	<b>18</b>

# 1 Schematic diagram

Figure 1. Schematic diagram (1/2 LM158W/LM258W/LM358W)



## 2 Absolute maximum ratings and operating conditions

Table 1. Absolute maximum ratings

Symbol	Parameter	LM158W/AW	LM258W/AW	LM358W/AW	Unit
$V_{CC}^+$	Supply voltage	+32			V
$V_{in}$	Input voltage	-0.3 to $V_{CC}^+ + 0.3$			
$V_{id}$	Differential input voltage	-0.3 to $V_{CC}^+ + 0.3$			
	Output short-circuit duration <sup>(1)</sup>	Infinite			
$I_{in}$	Input current <sup>(2)</sup>	5 mA in DC or 50 mA in AC (duty cycle=10%, T=1 s)			mA
$T_{oper}$	Operating free-air temperature range	-55 to +125	-40 to +105	0 to +70	°C
$T_{stg}$	Storage temperature range	-65 to +150			
$T_j$	Maximum junction temperature	150			
$R_{thja}$	Thermal resistance junction-to-ambient <sup>(3)</sup>				°C/W
	SO8	125			
	MiniSO8	190			
TSSOP8	120				
$R_{thjc}$	Thermal resistance junction-to-case <sup>(3)</sup>				
	SO8	40			
	MiniSO8	39			
	TSSOP8	37			
ESD	HBM: human body model <sup>(4)</sup>	2			kV
	MM: machine model <sup>(5)</sup>	200			V
	CDM: charged device model <sup>(6)</sup>	1.5			kV

- Short-circuits from the output to  $V_{CC}$  can cause excessive heating if  $V_{CC} > 15$  V. The maximum output current is approximately 40 mA independent of the magnitude of  $V_{CC}$ . Destructive dissipation can result from simultaneous short-circuits on all amplifiers.
- This input current only exists when the voltage at any of the input leads is driven negative. It is due to the collector-base junction of the input PNP transistor becoming forward biased and thereby acting as input diode clamps. In addition to this diode action, there is also NPN parasitic action on the IC chip. This transistor action can cause the output voltages of the op amps to go to the  $V_{CC}$  voltage level (or to ground for a large overdrive) for the time during which an input is driven negative. This is not destructive and normal output will be restored for input voltage higher than -0.3 V.
- Short-circuits can cause excessive heating and destructive dissipation.  $R_{th}$  are typical values.
- Human body model: a 100 pF capacitor is discharged through a 1.5 kΩ resistor between two pins of the device, done for all couples of pin combinations with other pins floating.
- Machine model: a 200 pF capacitor is charged to the specified voltage, then discharged directly between two pins of the device with no external series resistor (internal resistor < 5 Ω), done for all couples of pin combinations with other pins floating.
- Charged device model: all pins plus package are charged together to the specified voltage and then discharged directly to the ground.

Table 2. Operating conditions

Symbol	Parameter	Value	Unit
$V_{CC}^+$	Supply voltage	3 to 30	V
$V_{icm}$	Common mode input voltage range <sup>(1)</sup>	$V_{DD} - 0.3$ to $V_{CC} - 1.5$	
$T_{oper}$	Operating free air temperature range		°C
	LM158W	-55 to +125	
	LM258W LM358W	-40 to +105 0 to +70	

1. When used in comparator, the functionality is guaranteed as long as at least one input remains within the operating common mode voltage range.

### 3 Electrical characteristics

**Table 3.  $V_{CC}^+ = +5\text{ V}$ ,  $V_{CC}^- = \text{ground}$ ,  $V_o = 1.4\text{ V}$ ,  $T_{\text{amb}} = +25\text{ }^\circ\text{C}$   
(unless otherwise specified)**

Symbol	Parameter	Min.	Typ.	Max.	Unit
$V_{io}$	Input offset voltage <sup>(1)</sup>				
	LM158AW		1	2	mV
	LM258AW, LM358AW		1	3	
	LM158W, LM258W		2	5	
LM358W		2	7		
	$T_{\text{min}} \leq T_{\text{amb}} \leq T_{\text{max}}$				
	LM158AW, LM258AW, LM358AW			4	
	LM158W, LM258W			7	
	LM358W			9	
$\Delta V_{io}/\Delta T$	Input offset voltage drift				$\mu\text{V}/^\circ\text{C}$
	LM158AW, LM258AW, LM358AW		7	15	
	LM158W, LM258W, LM358W		7	30	
$I_{io}$	Input offset current				nA
	LM158AW, LM258AW, LM358AW		2	10	
	LM158W, LM258W, LM358W		2	30	
	$T_{\text{min}} \leq T_{\text{amb}} \leq T_{\text{max}}$				
	LM158AW, LM258AW, LM358AW			30	
	LM158W, LM258W, LM358W			40	
$\Delta I_{io}/\Delta T$	Input offset current drift				$\text{pA}/^\circ\text{C}$
	LM158AW, LM258AW, LM358AW		10	200	
	LM158W, LM258W, LM358W		10	300	
$I_{ib}$	Input bias current <sup>(2)</sup>				nA
	LM158AW, LM258AW, LM358AW		20	50	
	LM158W, LM258W, LM358W		20	150	
	$T_{\text{min}} \leq T_{\text{amb}} \leq T_{\text{max}}$				
	LM158AW, LM258AW, LM358AW			100	
	LM158W, LM258W, LM358W			200	
$A_{vd}$	Large signal voltage gain				V/mV
	$V_{CC}^+ = +15\text{ V}$ , $R_L = 2\text{ k}\Omega$ , $V_o = 1.4\text{ V}$ to $11.4\text{ V}$	50	100		
	$T_{\text{min}} \leq T_{\text{amb}} \leq T_{\text{max}}$	25			
SVR	Supply voltage rejection ratio				dB
	$R_s \leq 10\text{ k}\Omega$ , $V_{CC}^+ = 5\text{ V}$ to $30\text{ V}$	65	100		
	$T_{\text{min}} \leq T_{\text{amb}} \leq T_{\text{max}}$	65			
$I_{CC}$	Supply current, all amp, no load				mA
	$T_{\text{min}} \leq T_{\text{amb}} \leq T_{\text{max}}$ , $V_{CC}^+ = +5\text{ V}$		0.7	1.2	
	$T_{\text{min}} \leq T_{\text{amb}} \leq T_{\text{max}}$ , $V_{CC}^+ = +30\text{ V}$			2	

**Table 3.  $V_{CC}^+ = +5\text{ V}$ ,  $V_{CC}^- = \text{ground}$ ,  $V_o = 1.4\text{ V}$ ,  $T_{\text{amb}} = +25\text{ }^\circ\text{C}$   
(unless otherwise specified) (continued)**

Symbol	Parameter	Min.	Typ.	Max.	Unit
$V_{\text{icm}}$	Input common mode voltage range $V_{CC}^+ = +30\text{ V}^{(3)}$ $T_{\text{amb}} = +25\text{ }^\circ\text{C}$ $T_{\text{min}} \leq T_{\text{amb}} \leq T_{\text{max}}$	0 0		$V_{CC}^+ - 1.5$ $V_{CC}^+ - 2$	V
CMR	Common mode rejection ratio $R_s \leq 10\text{ k}\Omega$ $T_{\text{min}} \leq T_{\text{amb}} \leq T_{\text{max}}$	70 60	85		dB
$I_{\text{source}}$	Output current source $V_{CC}^+ = +15\text{ V}$ , $V_o = +2\text{ V}$ , $V_{\text{id}} = +1\text{ V}$	20	40	60	mA
$I_{\text{sink}}$	Output sink current $V_{CC}^+ = +15\text{ V}$ , $V_o = +2\text{ V}$ , $V_{\text{id}} = -1\text{ V}$ $V_{CC}^+ = +15\text{ V}$ , $V_o = +0.2\text{ V}$ , $V_{\text{id}} = -1\text{ V}$	10 12	20 50		mA $\mu\text{A}$
$V_{\text{OH}}$	High level output voltage $R_L = 2\text{ k}\Omega$ , $V_{CC}^+ = 30\text{ V}$ $T_{\text{min}} \leq T_{\text{amb}} \leq T_{\text{max}}$ $R_L = 10\text{ k}\Omega$ , $V_{CC}^+ = 30\text{ V}$ $T_{\text{min}} \leq T_{\text{amb}} \leq T_{\text{max}}$	26 26 27 27	27 28		V
$V_{\text{OL}}$	Low level output voltage $R_L = 10\text{ k}\Omega$ $T_{\text{min}} \leq T_{\text{amb}} \leq T_{\text{max}}$		5	20 20	mV
SR	Slew rate $V_{CC}^+ = 15\text{ V}$ , $V_i = 0.5\text{ to }3\text{ V}$ , $R_L = 2\text{ k}\Omega$ , $C_L = 100\text{ pF}$ , unity gain	0.3	0.6		V/ $\mu\text{s}$
GBP	Gain bandwidth product $V_{CC}^+ = 30\text{ V}$ , $f = 100\text{ kHz}$ , $V_{\text{in}} = 10\text{ mV}$ , $R_L = 2\text{ k}\Omega$ , $C_L = 100\text{ pF}$	0.7	1.1		MHz
THD	Total harmonic distortion $f = 1\text{ kHz}$ , $A_v = 20\text{ dB}$ , $R_L = 2\text{ k}\Omega$ , $V_o = 2\text{ V}_{\text{pp}}$ , $C_L = 100\text{ pF}$ , $V_o = 2\text{ V}_{\text{pp}}$		0.02		%
$e_n$	Equivalent input noise voltage $f = 1\text{ kHz}$ , $R_s = 100\text{ }\Omega$ , $V_{CC}^+ = 30\text{ V}$		55		$\frac{\text{nV}}{\sqrt{\text{Hz}}}$
$V_{o1}/V_{o2}$	Channel separation <sup>(4)</sup> $1\text{ kHz} \leq f \leq 20\text{ kHz}$		120		dB

- $V_o = 1.4\text{ V}$ ,  $R_s = 0\text{ }\Omega$ ,  $5\text{ V} < V_{CC}^+ < 30\text{ V}$ ,  $0 < V_{\text{ic}} < V_{CC}^+ - 1.5\text{ V}$ .
- The direction of the input current is out of the IC. This current is essentially constant, independent of the state of the output so there is no change in the load on the input lines.
- The input common-mode voltage of either input signal voltage should not be allowed to go negative by more than 0.3 V. The upper end of the common-mode voltage range is  $V_{CC}^+ - 1.5\text{ V}$ , but either or both inputs can go to +32 V without damage.
- Due to the proximity of external components ensure that there is no coupling originating via stray capacitance between these external parts. Typically, this can be detected at higher frequencies because then this type of capacitance increases.

Figure 2. Open loop frequency response



Figure 3. Large signal frequency response



Figure 4. Voltage follower pulse response (large signal)

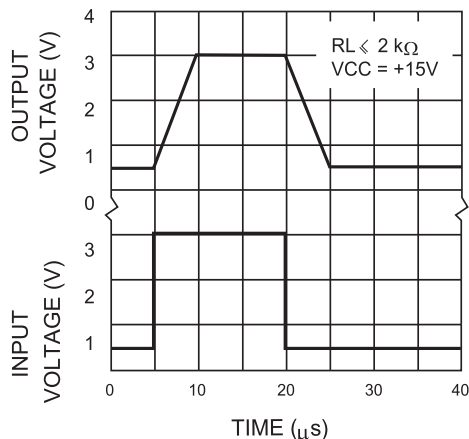


Figure 5. Voltage follower pulse response (small signal)

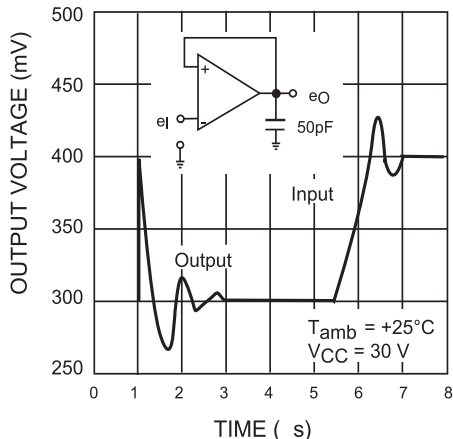


Figure 6. Input bias current vs. temperature

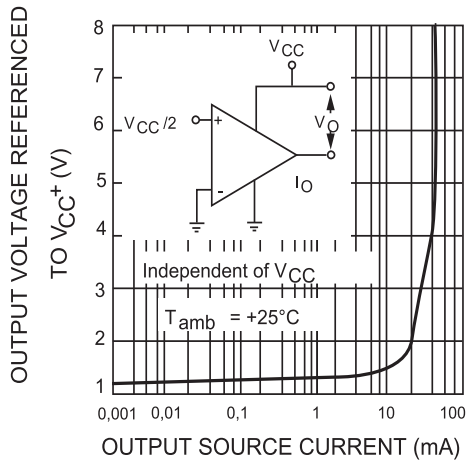


Figure 7. Output characteristics (sink)

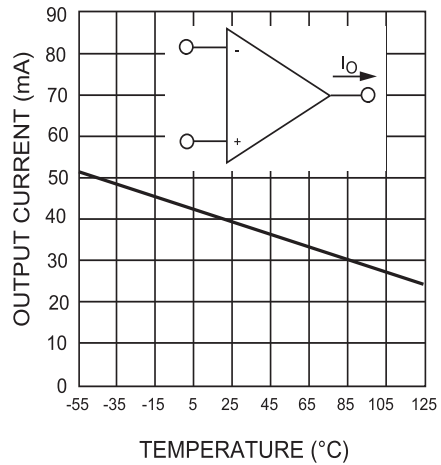




**Figure 8. Output characteristics (source)**



**Figure 9. Current limiting**



**Figure 10. Input voltage range**



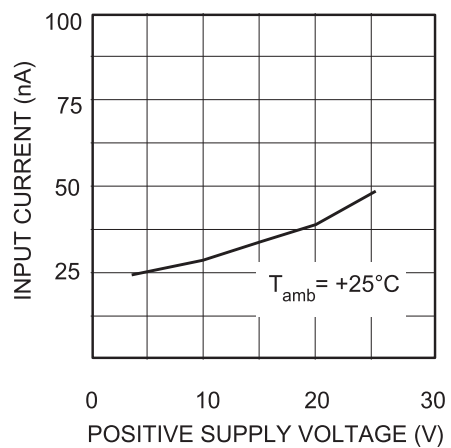
**Figure 11. Open loop gain**

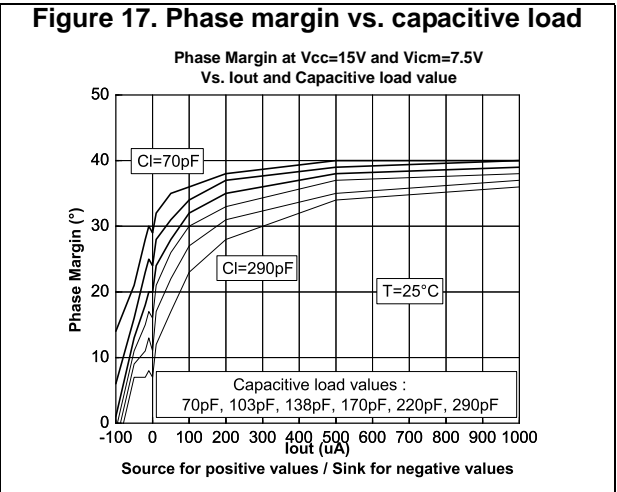
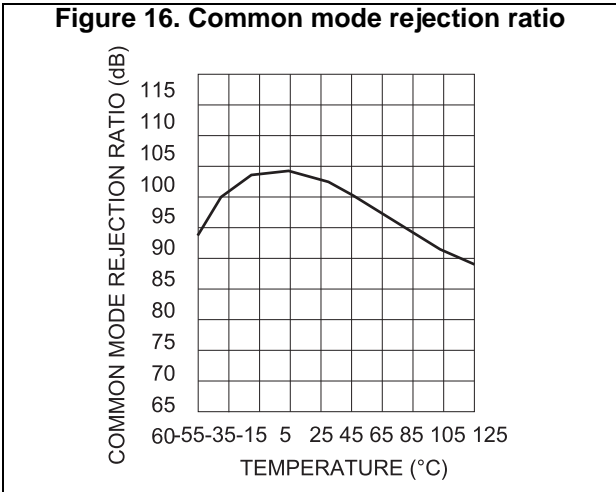


**Figure 12. Supply current**



**Figure 13. Input bias current vs. positive supply voltage**





# 4 Typical applications

Single supply voltage  $V_{CC} = +5 V_{DC}$



**Figure 24. Using symmetrical amplifiers to reduce input current**



**Figure 25. Low drift peak detector**



**Figure 26. Active band-pass filter**



## 5 Package information

In order to meet environmental requirements, ST offers these devices in different grades of ECOPACK packages, depending on their level of environmental compliance. ECOPACK specifications, grade definitions and product status are available at: [www.st.com](http://www.st.com). ECOPACK is an ST trademark.

## 5.1 SO8 package information

Figure 27. SO8 package outline

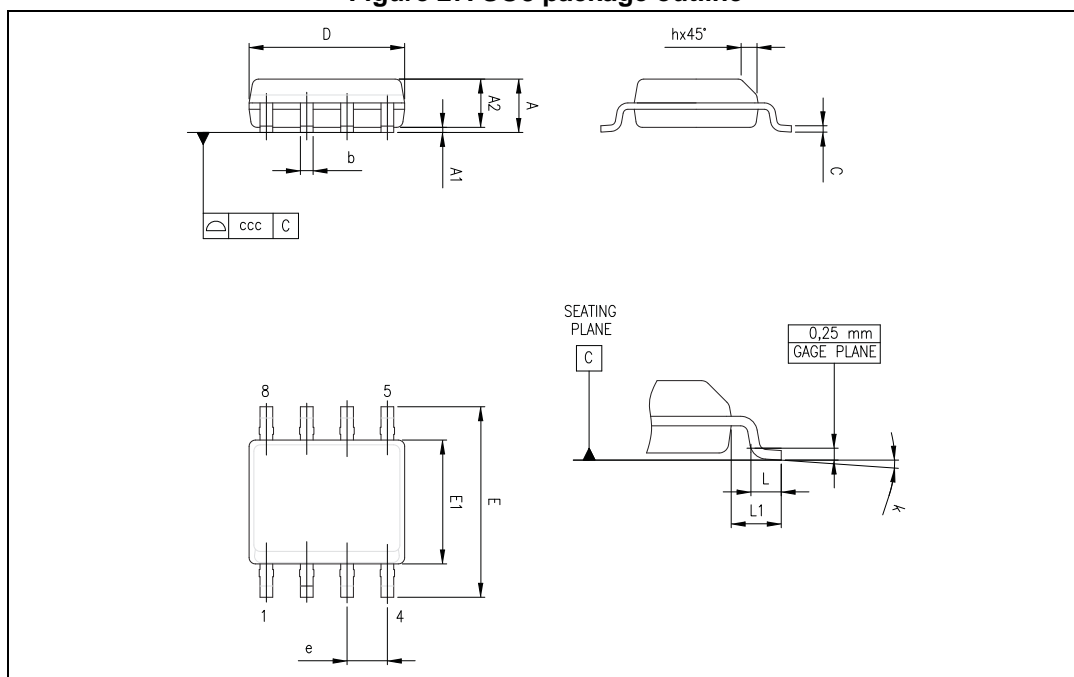


Table 4. SO8 package mechanical data

Ref.	Dimensions					
	Millimeters			Inches		
	Min.	Typ.	Max.	Min.	Typ.	Max.
A			1.75			0.069
A1	0.10		0.25	0.004		0.010
A2	1.25			0.049		
b	0.28		0.48	0.011		0.019
c	0.17		0.23	0.007		0.010
D	4.80	4.90	5.00	0.189	0.193	0.197
E	5.80	6.00	6.20	0.228	0.236	0.244
E1	3.80	3.90	4.00	0.150	0.154	0.157
e		1.27			0.050	
h	0.25		0.50	0.010		0.020
L	0.40		1.27	0.016		0.050
L1		1.04			0.040	
k	1 °		8 °	1 °		8 °
ccc			0.10			0.004

## 5.2 MiniSO8 package information

Figure 28. MiniSO8 package outline



Table 5. MiniSO8 package mechanical data

Ref.	Dimensions					
	Millimeters			Inches		
	Min.	Typ.	Max.	Min.	Typ.	Max.
A			1.1			0.043
A1	0		0.15	0		0.006
A2	0.75	0.85	0.95	0.030	0.033	0.037
b	0.22		0.40	0.009		0.016
c	0.08		0.23	0.003		0.009
D	2.80	3.00	3.20	0.11	0.118	0.126
E	4.65	4.90	5.15	0.183	0.193	0.203
E1	2.80	3.00	3.10	0.11	0.118	0.122
e		0.65			0.026	
L	0.40	0.60	0.80	0.016	0.024	0.031
L1		0.95			0.037	
L2		0.25			0.010	
k	0°		8°	0°		8°
ccc			0.10			0.004

### 5.3 TSSOP8 package information

Figure 29. TSSOP8 package outline



Table 6. TSSOP8 package mechanical data

Ref.	Dimensions					
	Millimeters			Inches		
	Min.	Typ.	Max.	Min.	Typ.	Max.
A			1.2			0.047
A1	0.05		0.15	0.002		0.006
A2	0.80	1.00	1.05	0.031	0.039	0.041
b	0.19		0.30	0.007		0.012
c	0.09		0.20	0.004		0.008
D	2.90	3.00	3.10	0.114	0.118	0.122
E	6.20	6.40	6.60	0.244	0.252	0.260
E1	4.30	4.40	4.50	0.169	0.173	0.177
e		0.65			0.0256	
k	0°		8°	0°		8°
L	0.45	0.60	0.75	0.018	0.024	0.030
L1		1			0.039	
aaa		0.1			0.004	



## 6 Ordering information

Table 7. Order codes

Order code	Temperature range	Package	Packing	Marking		
LM158WDT	-55 °C, +125 °C	SO8	Tape and reel	158W		
LM258AWDT	-40 °C, +105 °C			TSSOP8	258AW	
LM258WDT					258W	
LM258WPT					258W	
LM258WYDT <sup>(1)</sup>					SO8 (automotive grade)	258WY
LM258WYPT					TSSOP8 (automotive grade)	258WY
LM258AWYPT					K410	
LM358WST		0 °C, +70 °C		MiniSO8	K417	
LM358AWDT	SO8			358AW		
LM358AWPT	TSSOP8					
LM358AWST	MiniSO8			K418		
LM358WDT	SO8			358W		

1. Qualification and characterization according to AEC Q100 and Q003 or equivalent, advanced screening according to AEC Q001 & Q 002 or equivalent are qualified.

## 7 Revision history

**Table 8. Document revision history**

Date	Revision	Changes
01-Nov-2002	1	First release.
01-Jul-2005	2	ESD protection inserted in <i>Table 1: Absolute maximum ratings on page 4</i> .
06-Oct-2006	3	ESD tolerance for model HBM improved to 2kV in <i>Table 1: Absolute maximum ratings on page 4</i> . R <sub>thja</sub> and R <sub>thjc</sub> typical values added in <i>Table 1: Absolute maximum ratings on page 4</i> . Added <i>Figure 17: Phase margin vs. capacitive load on page 10</i> .
02-Jan-2007	4	Order codes added (automotive grade level) to <i>Section 6: Ordering information</i> .
15-Mar-2007	5	Previously called revision 4. Footnote for automotive grade order codes added to <i>Section 6: Ordering information</i> .
25-Apr-2007	6	Added missing Revision 4 of January 2007 in revision history. Corrected revision number of March 2007 to Revision 5.
11-Feb-2008	7	Reformatted electrical characteristics table. Reformatted package information. Corrected MiniSO8 package information. Corrected operating temperature range for automotive grade parts.
26-Aug-2008	8	Corrected ESD values in <i>Table 1: Absolute maximum ratings</i> . Added limitations on input current in <i>Table 1: Absolute maximum ratings</i> . Corrected title for <i>Figure 11</i> . Added E and L1 parameters in <i>Table 4: SO8 package mechanical data</i> . Added automotive grade products for MSO8 package in <i>Table 7: Order codes</i> .
03-Jul-2012	9	Automotive grade level updated in <i>Table 7: Order codes</i> . Removed order codes: LM358WYD, LM358AWYD, LM258WYD, LM258AWYD.
09-Jan-2013	10	Small text changes in <i>Features and Description</i> . <i>Figure 1: Schematic diagram (1/2 LM158W/LM258W/LM358W)</i> : replaced. <i>Table 7: Order codes</i> : added order codes LM358WST and LM358AWST.
15-Jul-2013	11	<i>Table 3</i> : replaced DV <sub>io</sub> with $\Delta V_{io}/\Delta T$ and DI <sub>io</sub> with $\Delta I_{io}/\Delta T$ <i>Table 7: Order codes</i> : removed the following order codes: LM158WN, LM158WD, LM258AWYST, LM258WAN, LM258WAD, LM258WD, LM258WYST, LM358WN, LM358WD, LM358AWD, LM358WDT, LM358AWDT, LM358WPT, LM358AWPT, LM358WYDT, LM358AWYDT, LM358AWYPT; updated footnote 1.

Table 8. Document revision history

Date	Revision	Changes
18-Sep-2014	12	Removed DIP8 package <i>Table 7: Order codes:</i> removed the order codes LM258WN, LM258AWYDT, LM258AWPT, LM358AWYST, LM358WYST, and LM358WYPT; added the order codes LM258WYDT, LM358AWDT, LM358AWPT, and LM358WDT.
06-May-2015	13	<i>Section 5: Package information:</i> replaced “package mechanical drawing” with “package outline”. <i>Table 7: Order codes:</i> removed “tube” packaging from all products
31-Jul-2019	14	Updated <a href="#">Table 7: Order codes</a> .

**IMPORTANT NOTICE – PLEASE READ CAREFULLY**

STMicroelectronics NV and its subsidiaries ("ST") reserve the right to make changes, corrections, enhancements, modifications, and improvements to ST products and/or to this document at any time without notice. Purchasers should obtain the latest relevant information on ST products before placing orders. ST products are sold pursuant to ST's terms and conditions of sale in place at the time of order acknowledgement.

Purchasers are solely responsible for the choice, selection, and use of ST products and ST assumes no liability for application assistance or the design of Purchasers' products.

No license, express or implied, to any intellectual property right is granted by ST herein.

Resale of ST products with provisions different from the information set forth herein shall void any warranty granted by ST for such product.

ST and the ST logo are trademarks of ST. For additional information about ST trademarks, please refer to [www.st.com/trademarks](http://www.st.com/trademarks). All other product or service names are the property of their respective owners.

Information in this document supersedes and replaces information previously supplied in any prior versions of this document.

© 2019 STMicroelectronics – All rights reserved



## Стандарт Электрон Связь

Мы молодая и активно развивающаяся компания в области поставок электронных компонентов. Мы поставляем электронные компоненты отечественного и импортного производства напрямую от производителей и с крупнейших складов мира.

Благодаря сотрудничеству с мировыми поставщиками мы осуществляем комплексные и плановые поставки широчайшего спектра электронных компонентов.

Собственная эффективная логистика и склад в обеспечивает надежную поставку продукции в точно указанные сроки по всей России.

Мы осуществляем техническую поддержку нашим клиентам и предпродажную проверку качества продукции. На все поставляемые продукты мы предоставляем гарантию .

Осуществляем поставки продукции под контролем ВП МО РФ на предприятия военно-промышленного комплекса России , а также работаем в рамках 275 ФЗ с открытием отдельных счетов в уполномоченном банке. Система менеджмента качества компании соответствует требованиям ГОСТ ISO 9001.

Минимальные сроки поставки, гибкие цены, неограниченный ассортимент и индивидуальный подход к клиентам являются основой для выстраивания долгосрочного и эффективного сотрудничества с предприятиями радиоэлектронной промышленности, предприятиями ВПК и научно-исследовательскими институтами России.

С нами вы становитесь еще успешнее!

### Наши контакты:

**Телефон:** +7 812 627 14 35

**Электронная почта:** [sales@st-electron.ru](mailto:sales@st-electron.ru)

**Адрес:** 198099, Санкт-Петербург,  
Промышленная ул, дом № 19, литера Н,  
помещение 100-Н Офис 331