

FEATURES

- **-3dB Bandwidth: 150MHz**
- **0.1dB Gain Flatness: 30MHz**
- **Channel-to-Channel Switching Time: 25ns**
- Turn-On/Turn-Off Time: 25ns
- High Slew Rate: 300V/ μ s
- Disabled Output Impedance: 10M Ω
- 50mV Switching Transient
- Channel Separation at 10MHz: >90dB
- Differential Gain: 0.02%
- Differential Phase: 0.02°
- Wide Supply Range: \pm 5V to \pm 15V
- Output Short-Circuit Protected
- Push-Pull Output

APPLICATIONS

- Broadcast Quality Video Multiplexing
- Picture-in-Picture Switching
- HDTV
- Computer Graphics
- Title Generation
- Video Crosspoint Matrices
- Video Routers

DESCRIPTION

The LT1203 is a wideband 2-input video multiplexer designed for pixel switching and broadcast quality routing. The LT1205 is a dual version that is configured as a 4-input, 2-output multiplexer.

These multiplexers act as SPDT video switches with 10ns transition times at toggle rates up to 30MHz. The -3dB bandwidth is 150MHz and 0.1dB gain flatness is 30MHz. Many parts can be tied together at their outputs by using the enable feature which reduces the power dissipation and raises the output impedance to 10M Ω . Output capacitance when disabled is only 3pF and the LT1203 peaks less than 3dB into a 50pF load. Channel crosstalk and disable isolation are greater than 90dB up to 10MHz. An on-chip buffer interfaces to fast TTL or CMOS logic. Switching transients are only 50mV with a 25ns duration. The LT1203 and LT1205 outputs are protected against shorts to ground.

The LT1203/LT1205 are manufactured using Linear Technology's proprietary complementary bipolar process. The LT1203 is available in both the 8-lead PDIP and SO package while the LT1205 is available in the 16-lead narrow body SO package.

TYPICAL APPLICATION

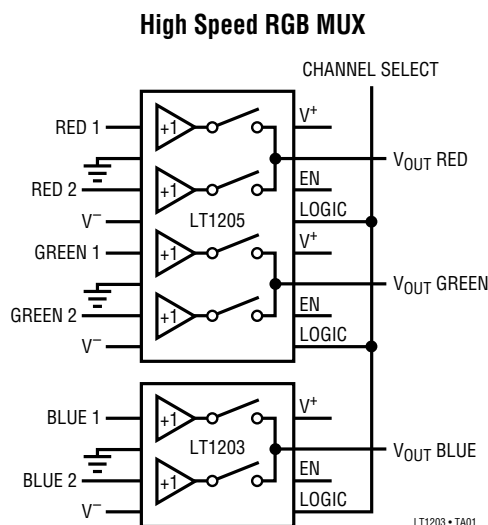

Large-Signal Response

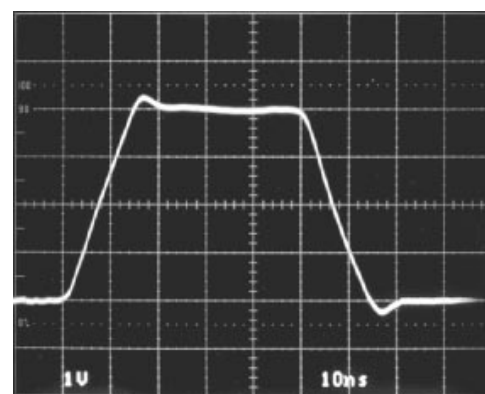

ABSOLUTE MAXIMUM RATINGS

Supply Voltage	±18V	Operating Temperature Range	–40°C to 85°C
Signal Input Current (Note 1)	±20mA	Storage Temperature Range	–65°C to 150°C
Logic Input Current (Note 2)	±50mA	Junction Temperature (Note 5)	150°C
Output Short-Circuit Duration (Note 3)	Continuous	Lead Temperature (Soldering, 10 sec)	300°C
Specified Temperature Range (Note 4)	0°C to 70°C		

PACKAGE/ORDER INFORMATION

<p>N8 PACKAGE 8-LEAD PLASTIC DIP S8 PACKAGE 8-LEAD PLASTIC SOIC</p> <p>$T_{JMAX} = 150^{\circ}C, \theta_{JA} = 100^{\circ}C/W$ (N) $T_{JMAX} = 150^{\circ}C, \theta_{JA} = 150^{\circ}C/W$ (S)</p>	ORDER PART NUMBER	<p>S PACKAGE 16-LEAD PLASTIC SOIC</p> <p>$T_{JMAX} = 150^{\circ}C, \theta_{JA} = 100^{\circ}C/W$</p>	ORDER PART NUMBER
	LT1203CN8* LT1203CS8*		LT1205CS*
	S8 PART MARKING		
	1203		

*See Note 4
Consult factory for Industrial and Military grade parts.

ELECTRICAL CHARACTERISTICS

0°C ≤ T_A ≤ 70°C, ±5V ≤ V_S ≤ ±15V, R_L = 1k, pulse tested, EN pin open or high, unless otherwise noted.

SYMBOL	PARAMETER	CONDITIONS	MIN	TYP	MAX	UNITS	
V _{OS}	Output Offset Voltage	Any Input Selected	●	10	30	mV	
	Output Offset Matching	Between Outputs	●	0.3	5	mV	
ΔV _{OS} /ΔT	Output Offset Drift		●	40		μV/°C	
I _{IN}	Input Current		●	0.6	5	μA	
R _{IN}	Input Resistance	V _S = ±5V, V _{IN} = ±2V	●	1	5	MΩ	
		V _S = ±15V, V _{IN} = ±2V	●	2	5	MΩ	
C _{IN}	Input Capacitance	Input Selected		2.6		pF	
		Input Deselected		2.6		pF	
C _{OUT}	Disabled Output Capacitance	EN Pin Voltage ≤ 0.8V		2.8		pF	
V _{IN}	Input Voltage (Note 1)	V _S = ±5V	●	±2	±2.8	V	
		V _S = ±15V	●	±2	±3.0	V	
PSRR	Power Supply Rejection Ratio	V _S = ±4.5 to ±15V	●	60	70	dB	
		V _S = ±15V, V _{IN} = ±2V, R _L = 1k	●		2	4	%
		V _S = ±15V, V _{IN} = ±2V, R _L = 400Ω	●		6	10	%
		V _S = ±5V, V _{IN} = ±2V, R _L = 1k	●		3	6	%

ELECTRICAL CHARACTERISTICS

0°C ≤ T_A ≤ 70°C, ±5V ≤ V_S ≤ ±15V, R_L = 1k, pulse tested, EN pin open or high, unless otherwise noted.

SYMBOL	PARAMETER	CONDITIONS		MIN	TYP	MAX	UNITS
V _{OUT}	Output Voltage	V _S = ±15V, V _{IN} = ±2V, R _L = 400Ω V _S = ±5V, V _{IN} = ±2V, R _L = 1k	● ●	±1.8 ±1.8	±1.90 ±1.94		V V
	Overload Swing (Note 1)	V _S = ±15V, V _{IN} = ±5V V _S = ±5V, V _{IN} = ±5V	● ●		±0.9 ±0.9	±1.5 ±1.5	V V
I _{OUT}	Output Current	V _S = ±15V, V _{IN} = ±2V, R _L = 400Ω V _S = ±5V, V _{IN} = ±2V, R _L = 1k	● ●	±4.5 ±1.8	±4.75 ±2.00		mA mA
	Enabled Output Resistance Disabled Output Resistance	EN Pin Voltage = 2V, V _{OUT} = ±2V, V _S = ±15V EN Pin Voltage = 0.5V, V _{OUT} = ±2V, V _S = ±15V	● ●		20 10	42	Ω MΩ
I _S	Supply Current (LT1203)	EN Pin Voltage = 2V EN Pin Voltage = 0.5V	● ●		10.0 5.8	14 8	mA mA
	Supply Current (LT1205)	EN Pin Voltage = 2V EN Pin Voltage = 0.5V	● ●		20.0 11.6	28 16	mA mA
V _{IL}	Logic Low	Logic Pin	●			0.8	V
V _{IH}	Logic High	Logic Pin	●	2			V
	Enable Low	EN Pin	●			0.5	V
	Enable High	EN Pin	●	2			V
I _{IL}	Digital Input Current Low	LT1203 Pin 5, LT1205 Pins 9, 13 = 0V	●		1.5	6.5	μA
I _{IH}	Digital Input Current High	LT1203 Pin 5, LT1205 Pins 9, 13 = 5V	●		10	200	nA
I _{EN}	Enable Pin Current	LT1203 Pin 6, LT1205 Pins 10, 14	●		20	80	μA

AC CHARACTERISTICS T_A = 25°C, V_S = ±15V, R_L = 1k, EN pin open or high, unless otherwise noted.

SYMBOL	PARAMETER	CONDITIONS		MIN	TYP	MAX	UNITS
SR	Slew Rate (Note 6)			180	300		V/μs
FPBW	Full Power Bandwidth (Note 7)	V _{OUT} = 2V _{P-P}		28.6	47.7		MHz
t _{SEL}	Channel-to-Channel Select Time (Note 8)	R _L = 10k			25	35	ns
	Enable Time (Note 9)	R _L = 1k			25	35	ns
	Disable Time (Note 9)	R _L = 1k			20	35	ns
t _r , t _f	Small-Signal Rise and Fall Time	V _{OUT} = 250mV _{P-P} , 10% to 90%			2.6		ns
	Propagation Delay	V _{OUT} = 250mV _{P-P}			2.9		ns
	Overshoot	V _{OUT} = 250mV _{P-P}			5		%
	Crosstalk (Note 10)	R _S = 10Ω			90		dB
	Chip Disabled Crosstalk (Note 10)	R _L = 10Ω, EN Pin Voltage ≤ 0.8V			110		dB
	Channel Select Output Transient	All V _{IN} = 0V			50		mV _{P-P}
t _S	Settling Time	1%, V _{OUT} = 1V			30		ns
	Differential Gain (Note 11)	V _S = ±15V, R _L = 10k			0.02		%
	Differential Phase (Note 11)	V _S = ±15V, R _L = 10k			0.02		DEG
	Insertion Loss	R _L = 100k, C _L = 30pF, V _{OUT} = 500mV _{P-P} , f = 1MHz			0.02		dB

The ● denotes specifications which apply over the specified temperature range.

Note 1: The analog inputs (pins 1, 3 for the LT1203, pins 1, 3, 5, 7 for the LT1205) are protected against ESD and overvoltage with internal SCRs.

For inputs ≤ ±2.8V the SCR will not fire. Voltages above 2.8V will fire the SCR and the DC current should be limited to 20mA. To turn off the SCR the pin voltage must be reduced to less than 1V or the current reduced to less than 600μA.

LT1203/LT1205

Note 2: The digital inputs (pins 5, 6 for the LT1203, pins 9, 10, 13, 14 for the LT1205) are protected against ESD and overvoltage with internal SCRs. For inputs $\leq \pm 6V$ the SCR will not fire. Voltages above 6V will fire the SCR and the DC current should be limited to 50mA. To turn off the SCR the pin voltage must be reduced to less than 2V or the current reduced to less than 10mA.

Note 3: A heat sink may be required depending on the power supply voltage.

Note 4: Commercial grade parts are designed to operate over the temperature range of $-40^{\circ}C$ to $85^{\circ}C$ but are neither tested nor guaranteed beyond $0^{\circ}C$ to $70^{\circ}C$. Industrial grade parts specified and tested over $-40^{\circ}C$ to $85^{\circ}C$ are available on special request, consult factory.

Note 5: T_J is calculated from the ambient temperature T_A and the power dissipation P_D according to the following formulas:

$$LT1203CN8: T_J = T_A + (P_D \times 100^{\circ}C/W)$$

$$LT1203CS8: T_J = T_A + (P_D \times 150^{\circ}C/W)$$

$$LT1205CS: T_J = T_A + (P_D \times 100^{\circ}C/W)$$

Note 6: Slew rate is measured at $\pm 2.0V$ on a $\pm 2.5V$ output signal while operating on $\pm 15V$ supplies, $R_L = 1k$.

Note 7: Full power bandwidth is calculated from the slew rate measurement:

$$FPBW = SR/2\pi V_{PEAK}$$

Note 8: For the LT1203, apply 1VDC to pin 1 and measure the time for the appearance of 0.5V at pin 7 when pin 5 goes from 5V to 0V. Apply 1VDC

to pin 1 and measure the time for disappearance of 0.5V at pin 7 when pin 5 goes from 0V to 5V. Apply 1VDC to pin 3 and measure the time for the appearance of 0.5V at pin 7 when pin 5 goes from 0V to 5V. Apply 1VDC to pin 3 and measure the time for disappearance of 0.5V at pin 7 when pin 5 goes from 5V to 0V. For the LT1205 the same test is performed on both MUXs.

Note 9: For the LT1203, apply 1VDC to pin 1 and measure the time for the appearance of 0.5V at pin 7 when pin 6 goes from 0V to 5V. Pin 5 voltage = 0V. Apply 1VDC to pin 1 and measure the time for disappearance of 0.2V at pin 7 when pin 6 goes from 5V to 0V. Pin 5 voltage = 0V. Apply 1VDC to pin 3 and measure the time for the appearance of 0.5V at pin 7 when pin 6 goes from 0V to 5V. Pin 5 voltage = 5V. Apply 1VDC to pin 3 and measure the time for disappearance of 0.2V at pin 7 when pin 5 goes from 5V to 0V. Pin 5 voltage = 5V. For the LT1205 the same test is performed on both MUXs.

Note 10: $V_{IN} = 0dBm$ ($0.223V_{RMS}$) at 10MHz on one input with the other input selected and $R_S = 10\Omega$. For disable crosstalk all inputs are driven simultaneously. In disable the output impedance is very high and signal couples across the package; the load impedance determines the crosstalk.

Note 11: Differential gain and phase are measured using a Tektronix TSG120 YC/NTSC signal generator and a Tektronix 1780R video measurement set. The resolution of this equipment is 0.1% and 0.1°. Ten identical MUXs were cascaded giving an effective resolution of 0.01% and 0.01°.

TRUTH TABLE

LOGIC	EN	V_{OUT}
0	1	V_{IN0}
1	1	V_{IN1}
0	0*	HIGH Z_{OUT}
1	0	HIGH Z_{OUT}

*Must be $\leq 0.5V$

TYPICAL PERFORMANCE CHARACTERISTICS

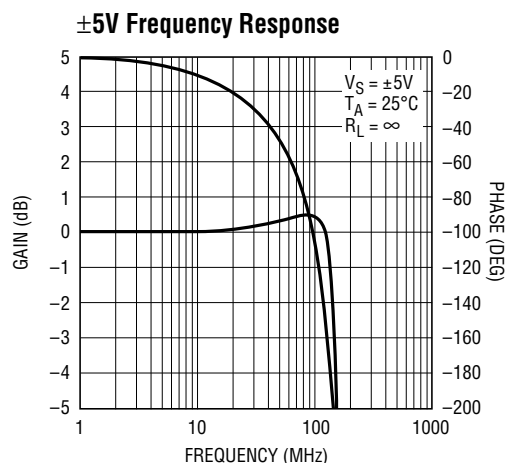

LT1203/05 • TPC01

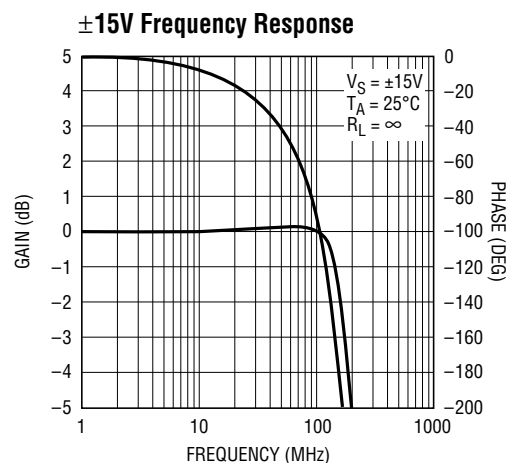

LT1203/05 • TPC02

TYPICAL PERFORMANCE CHARACTERISTICS

-3dB Bandwidth vs Supply Voltage

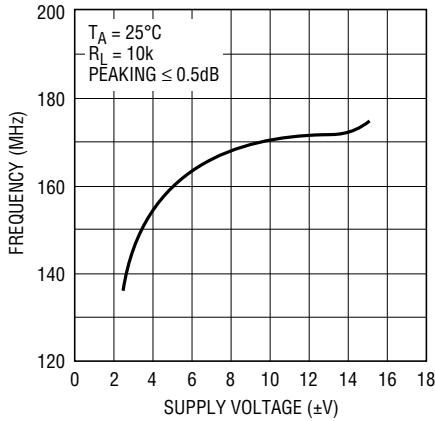

LT1203/05 • TPC03

Frequency Response with Capacitive Loads

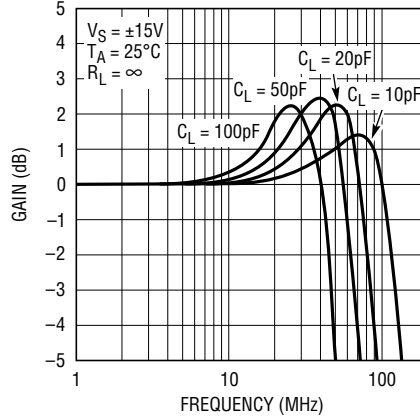

LT1203/05 • TPC04

Crosstalk Rejection vs Frequency

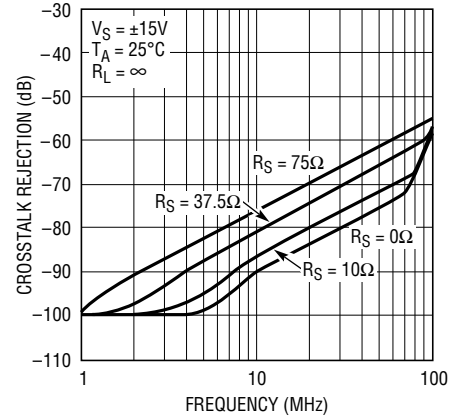

LT1203/05 • TPC05

Crosstalk Rejection vs Frequency

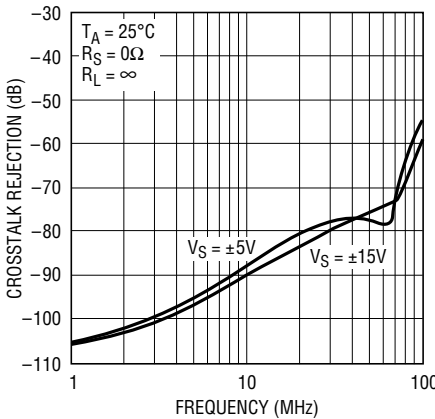

LT1203/05 • TPC06

Disable Rejection vs Frequency

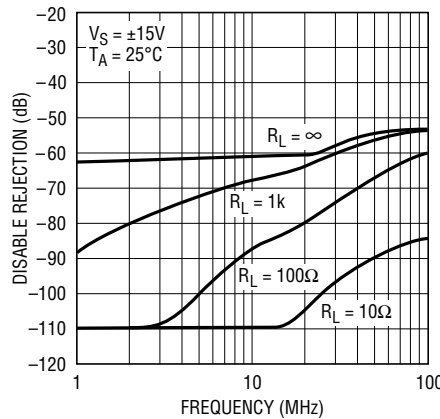

LT1203/05 • TPC07

Power Supply Rejection Ratio vs Frequency

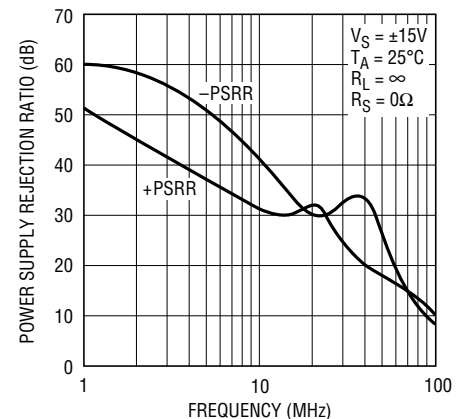

LT1203/05 • TPC08

Output Impedance (Enabled) vs Frequency

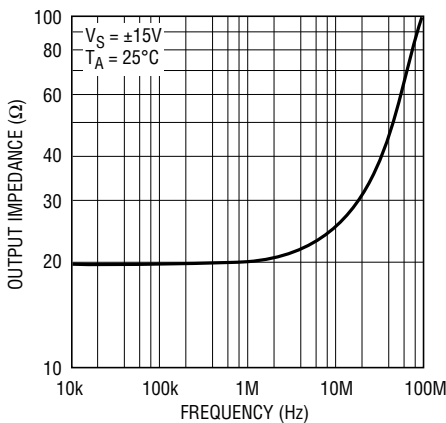

LT1203/05 • TPC09

Supply Current vs Supply Voltage (Enabled)

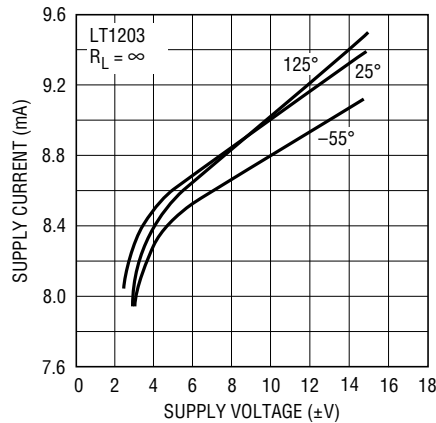

LT1203/05 • TPC10

Supply Current vs Supply Voltage (Disabled)

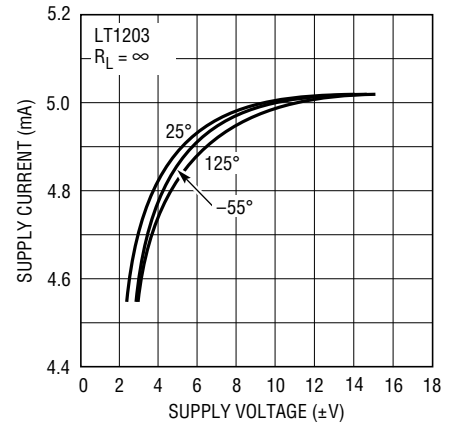

LT1203/05 • TPC11

TYPICAL PERFORMANCE CHARACTERISTICS

Gain Error vs Temperature

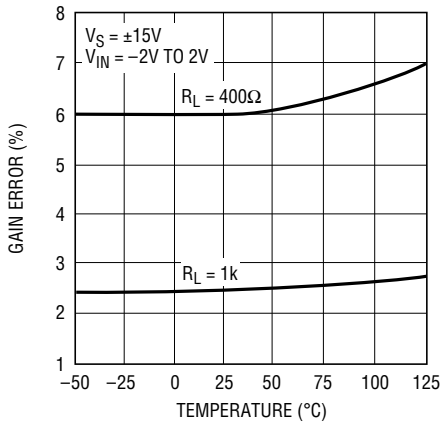

LT1203/05 • TPC12

Input Bias Current vs Input Voltage

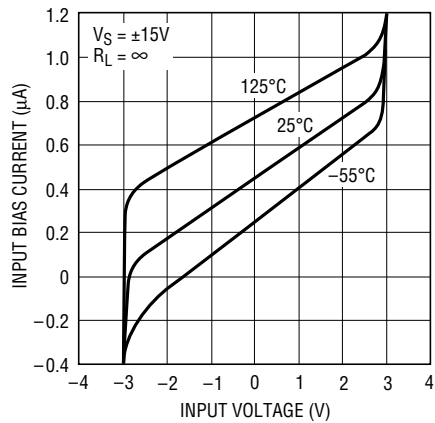

LT1203/05 • TPC13

Output Voltage vs Input Voltage

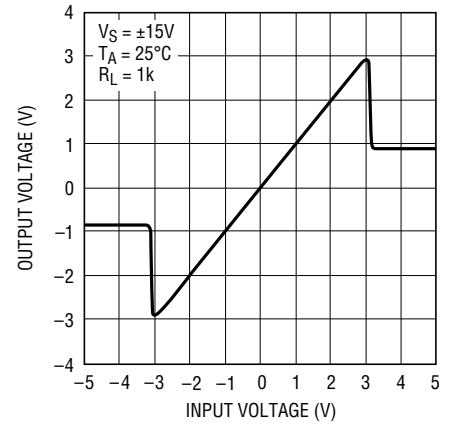

LT1203/05 • TPC14

Settling Time to 1mV and 10mV vs Output Step

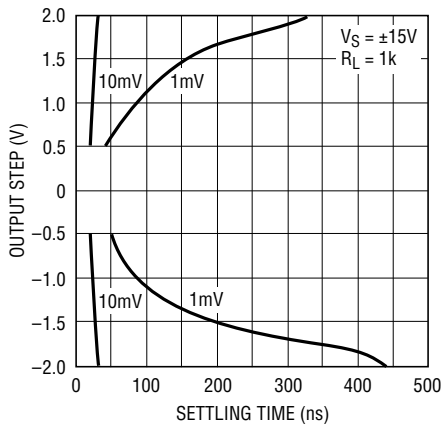

LT1203/05 • TPC15

Small-Signal Rise Time

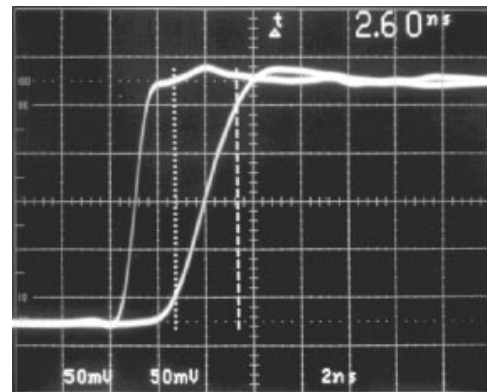

$R_L = 1k$

LT1203/05 • TPC16

V_{IN1} to V_{IN0} Select Time

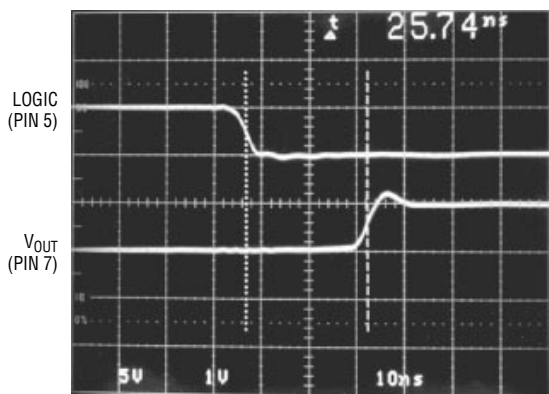

$V_S = \pm 15V$ $V_{IN0} = 1V$
 $R_L = 10k$ $V_{IN1} = 0V$

LT1203/05 • TPC17

V_{IN0} to V_{IN1} Select Time

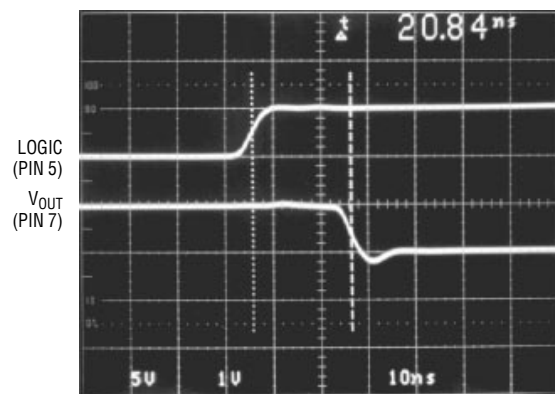

$V_S = \pm 15V$ $V_{IN0} = 1V$
 $R_L = 10k$ $V_{IN1} = 0V$

LT1203/05 • TPC18

TYPICAL PERFORMANCE CHARACTERISTICS

Channel 1 Enable

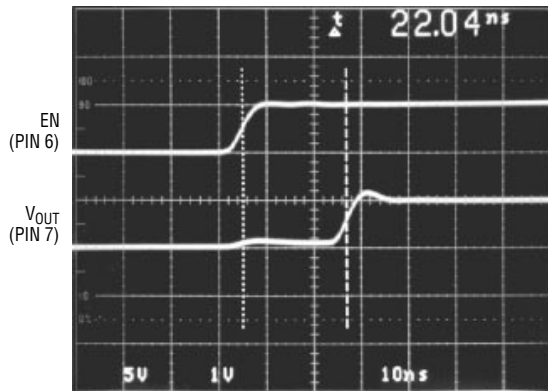

$V_S = \pm 15V$ $V_{IN0} = 1V$
 $R_L = 1k$ $V_{IN1} = 0V$
 LT1203/05 • TPC19

Channel 1 Disable

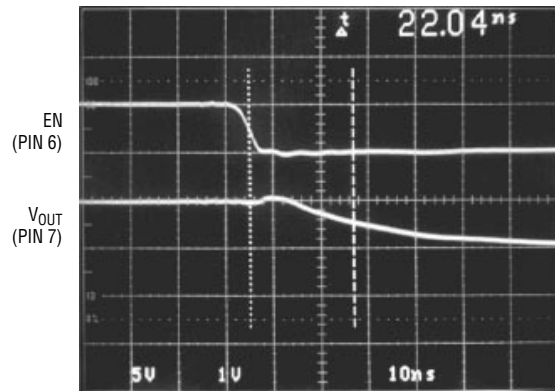

$V_S = \pm 15V$ $V_{IN0} = 1V$
 $R_L = 1k$ $V_{IN1} = 0V$
 LT1203/05 • TPC20

APPLICATIONS INFORMATION

Input Protection

The logic inputs have ESD protection ($\geq 2kV$) and shorting them to 12V or 15V will cause excessive current to flow. Limit the current to less than 50mA when driving the logic above 6V. The analog inputs are protected against ESD and overvoltage with internal SCRs. For inputs $\geq \pm 2.8V$ the SCRs will fire and the DC current should be limited to 20mA.

Power Supplies

The LT1203/LT1205 will operate from $\pm 5V$ (10V total) to $\pm 15V$ (30V total) and is specified over this range. Characteristics change very little over this voltage range. It is not necessary to use equal value supplies however, the output offset voltage will change. The offset will change about $300\mu V$ per volt of supply mismatch. The LT1203/LT1205 have a very wide bandwidth yet are tolerant of power supply bypassing. The power supplies should be bypassed with a $0.1\mu F$ or $0.01\mu F$ ceramic capacitor within 0.5 inch of the part.

Circuit Layout

Use a ground plane to ensure a low impedance ground is available throughout the PCB layout. Separate the inputs

with ground plane to ensure high channel separation. For minimum peaking, maximum bandwidth and maximum gain flatness sockets are not recommended because they can add considerable stray inductance and capacitance. If a socket must be used, use a low profile, low capacitance socket such as the SamTec ISO-308.

Switching Transients

The LT1203/LT1205 use input buffers to ensure switching transients do not couple to other video equipment sharing the input line. Output switching transients are about $50mV_{P-P}$ with a 20ns duration and input transients are

LT1203 Channel-to-Channel Switching Transient

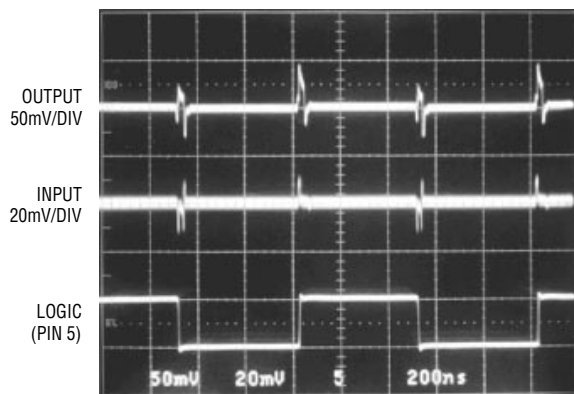

$R_S = 50\Omega$ LT1203/05 • A101

APPLICATIONS INFORMATION

CMOS MUX Channel-to-Channel Switching Transient

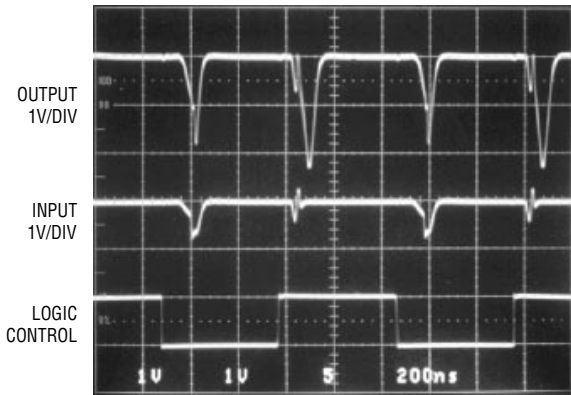

$R_S = 50\Omega$
NOTE: 50 TIMES LARGER THAN LT1203 TRANSIENT

LT1203 Switching Inputs

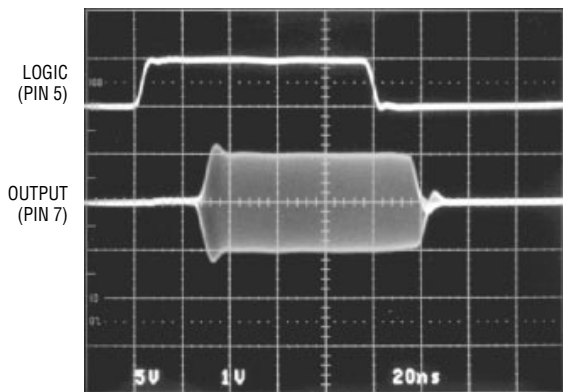

CHANNEL 1 = 0V
CHANNEL 2 = 2MHz SINEWAVE

only 10mV_{P-P}. A photo of the switching transients from a CMOS MUX shows glitches to be 50 times larger than on the LT1203. Also shown is the output of the LT1203 switching on and off a 2MHz sinewave cleanly and without abnormalities.

Pixel Switching

The multiplexers are fabricated on LTC's Complementary Bipolar Process to attain fast switching speed, high bandwidth, and a wide supply voltage range compatible with traditional video systems. Channel-to-channel switching time and Enable time are both 25ns, therefore delay is the same when switching between channels or between ICs. To demonstrate the switching speed of the LT1203/LT1205 the RGB MUX of Figure 1 is used to switch RGB Workstation inputs with a 22ns pixel width. Figure 2a is a photo showing the Workstation output and RGB MUX output. The slight rise time degradation at the RGB MUX output is due to the bandwidth of the LT1260 current feedback amplifier used to drive the 75Ω cable. In Figure 2b, the LT1203 switches to an input at zero at the end of the first pixel and removes the following pixels.

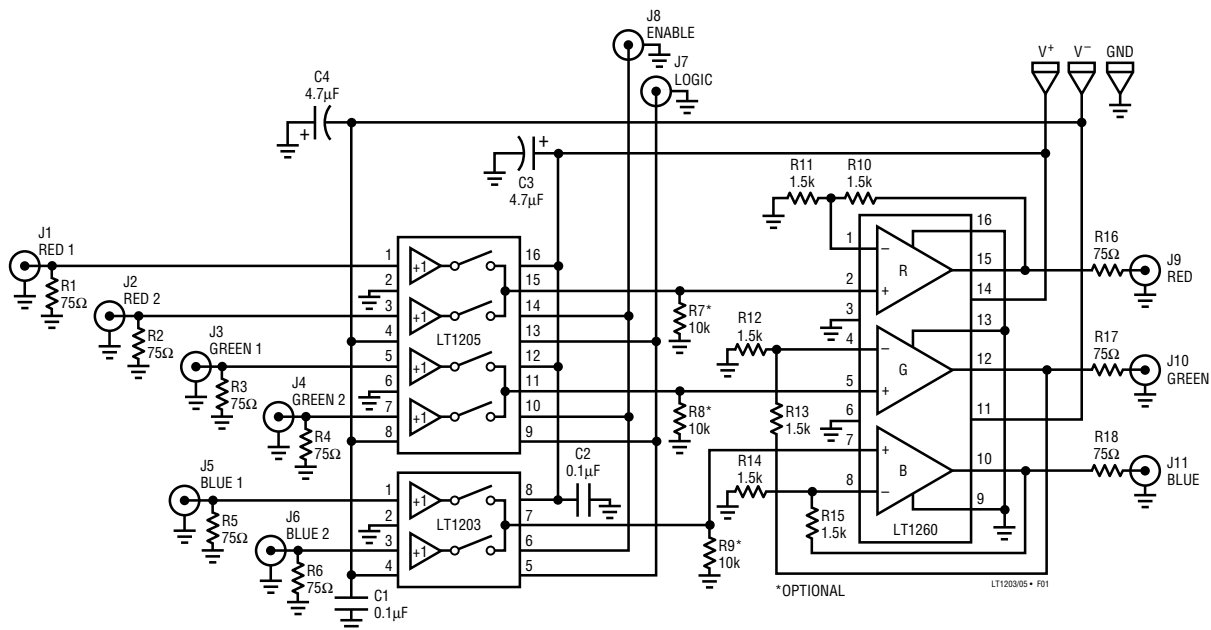
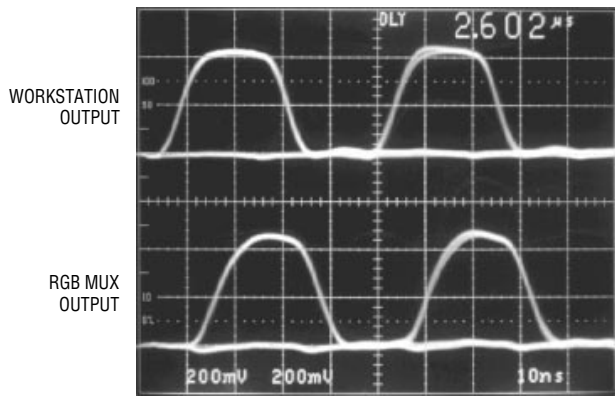

Figure 1. RGB MUX

APPLICATIONS INFORMATION



LT1203/05 • F02a

Figure 2a. Workstation and RGB MUX Output

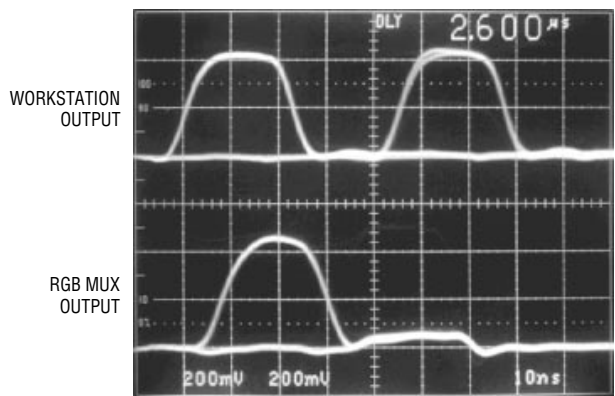

LT1203/05 • F02b

Figure 2b. RGB MUX Output Switched to Ground After One Pixel

Demonstration Board

A Demonstration Board (#041) of the RGB MUX in Figure 1 has been fabricated and its layout is shown in Figure 3. The small-signal bandwidth of the RGB MUX is set by the bandwidth of the LT1260. The stray capacitance of the surface mount feedback resistors R_F and R_G restricts the -3dB bandwidth to about 95MHz. The bandwidth can be improved by about 20% using the through-hole LT1260 and components. A frequency response plot in Figure 4 shows that the R, G, and B amplifiers have slightly different frequency responses. The difference in the G amplifier is due to different output trace routing to feedback resistor R13.

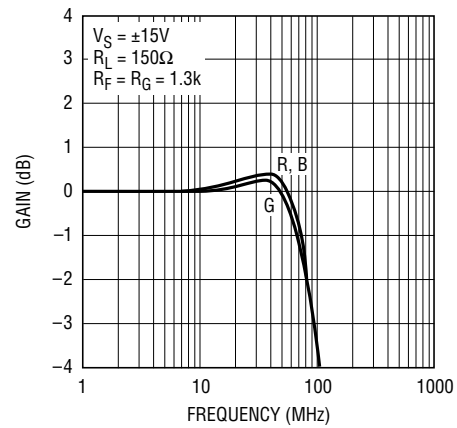

LT1203/05 • F04

Figure 4. RGB MUX Frequency Response of Demonstration Board #041

Input Expansion

The output impedance of the LT1203/LT1205 is typically 20Ω when enabled and $10\text{M}\Omega$ when disabled or not selected. This high disabled output impedance allows the output of many LT1205s to be shorted together to form large crosspoint arrays. With their outputs shorted together, shoot-through current is low because the “on” channel is disabled before the “off” channel is activated.

Timing and Supply Current Waveforms

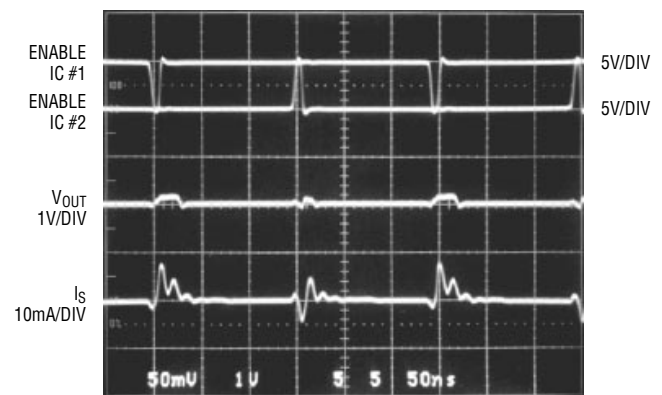

LT1203/05 • A104

Four LT1205s are used in Figure 5 to form a 16-to-1 multiplexer which is very space efficient and uses only six SO packages. In this application 15 switches are turned off and only one is active. An attenuator is formed by the 15 deselected switches and the active device which has an

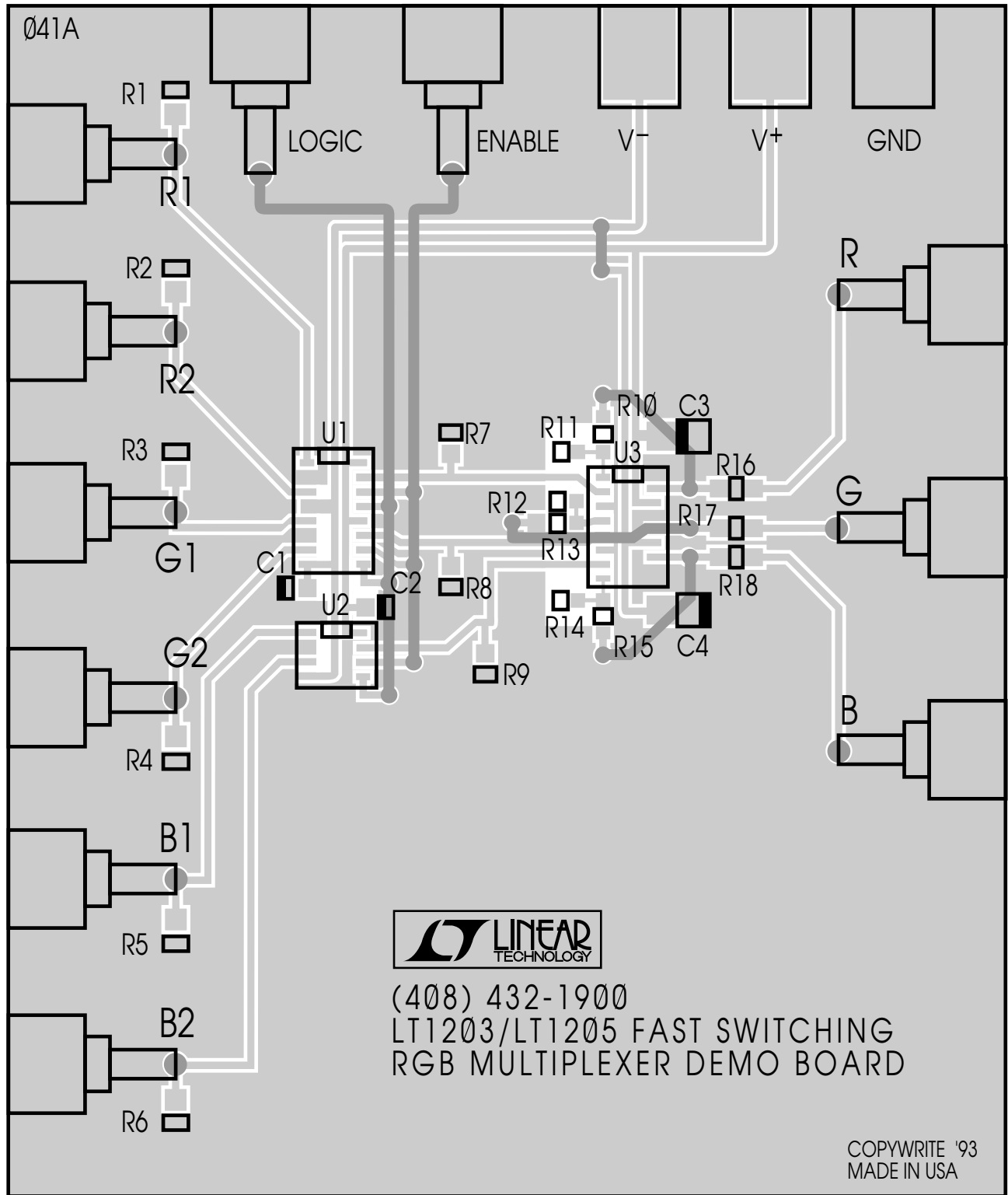

LT1205/03 • F03

Figure 3. Demo Board #041 Layout

APPLICATIONS INFORMATION

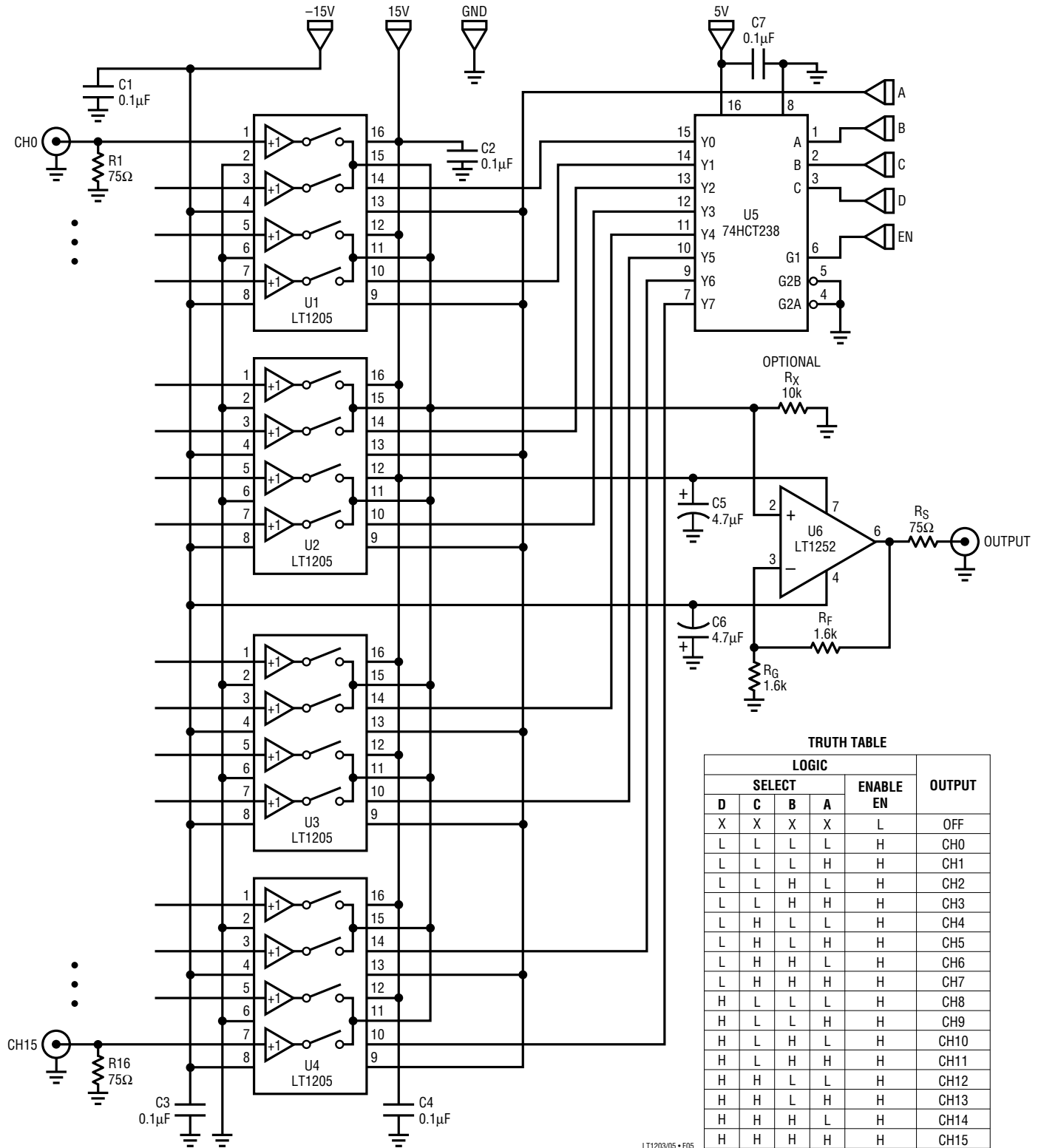

Figure 5. 16-to-1 Multiplexer and Truth Table

APPLICATIONS INFORMATION

output impedance of only 25Ω at 10MHz. This attenuator is responsible for the outstanding All Hostile Crosstalk Rejection of 90dB at 10MHz with 15 input signals.

Several suggestions to attain this high rejection include:

1. Mount the feedback resistors for the surface mount LT1252 on the back side of the PC board.
2. Keep the feedback trace (pin 3) of the LT1252 as short as possible.
3. Route V^+ and V^- for the LT1205s on the component (top) side and under the devices (between inputs and outputs).
4. Use the backside of the PC board as a solid ground plane. Connect the LT1205 device grounds and bypass capacitors grounds as vias to the backside ground plane.

16-to-1 MUX, Switching LT1205 Enable Lines

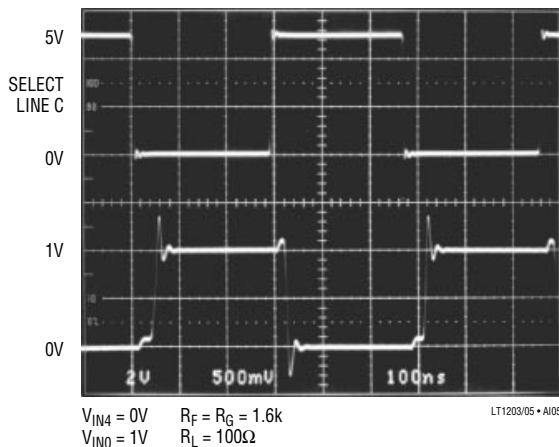

16-to-1 Multiplexer All Hostile Crosstalk Rejection

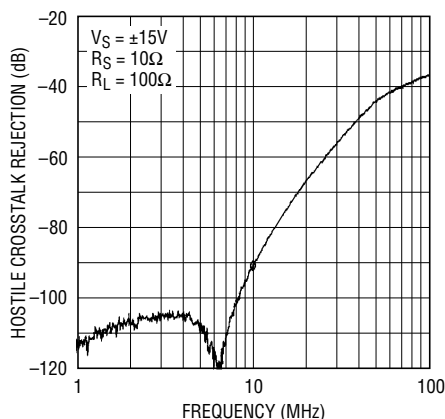

16-to-1 MUX Response

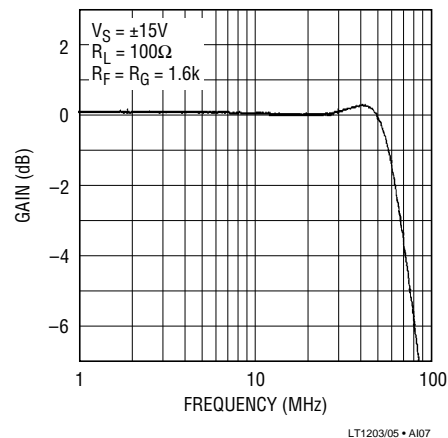

Each “off” switch has 2.8pF of output capacitance and 15 “off” switches tied together represent a 48pF load to the one active switch. In this case the active device will peak about 3dB at 50MHz. An attribute of current feedback amplifiers is that the bandwidth can easily be adjusted by changing the feedback resistors, and in this application the LT1252’s bandwidth is reduced to about 60MHz using 1.6k feedback resistors. This has the effect of reducing the peaking in the MUX to 0.25dB and flattening the response to 0.05dB at 30MHz.

4 × 4 Crosspoint

The compact high performance 4×4 crosspoint shown in Figure 6 uses four LT1205s to route any input to any or all outputs. The complete crosspoint uses only six SO packages and less than six square inches of PC board space. The LT1254 quad current feedback amplifier serves as a cable driver with a gain of 2. A $\pm 5V$ supply is used to ensure that the maximum $150^\circ C$ junction temperature of the LT1254 is not exceeded in the SO package. With this supply voltage the crosspoint can operate at a $70^\circ C$ ambient temperature and drive 2V (peak or DC) into a double-terminated 75Ω video cable. The feedback resistors of these output amplifiers have been optimized for this supply voltage. The $-3dB$ bandwidth of the crosspoint is over 100MHz with only 0.8dB of peaking. All Hostile Crosstalk Rejection is 85dB at 10MHz when a shorted input is routed to all outputs. To obtain this level of performance it is necessary to follow techniques similar to

APPLICATIONS INFORMATION

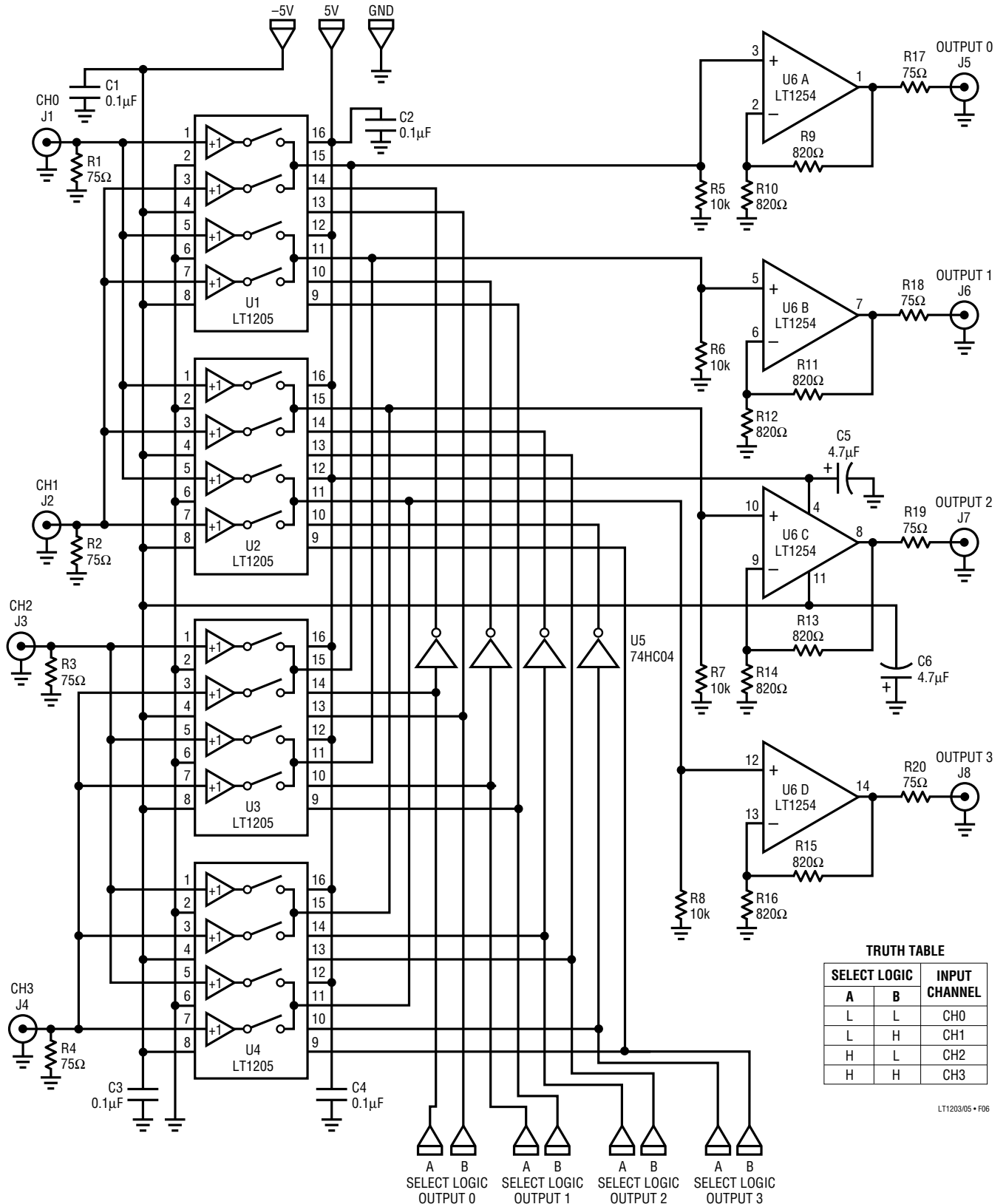

Figure 6. 4 × 4 Crosspoint and Truth Table

APPLICATIONS INFORMATION

those used in the 16-to-1 crosspoint with one additional suggestion: Surround the LT1205 output traces by ground plane and route them away from the (-) inputs of the other three LT1254s.

Each pair of logic inputs labeled Select Logic Output is used to select a particular output. The truth table is used to select the desired input and is applied to each pair of logic inputs. For example, to route Channel 1 Input to

Output 3, the 4th pair of logic inputs labeled Select Logic Output 3 is coded A = Low and B = High. To route Channel 3 Input to all outputs, set all eight logic inputs High. Channel 3 is the default input with all logic inputs open. To shut off all channels a pair of LT1259s can be substituted for the LT1254. The LT1259 is a dual current feedback amplifier with a shutdown pin that reduces the supply current to 0 μ A.

Response of All Four Inputs for the 4 × 4 Crosspoint

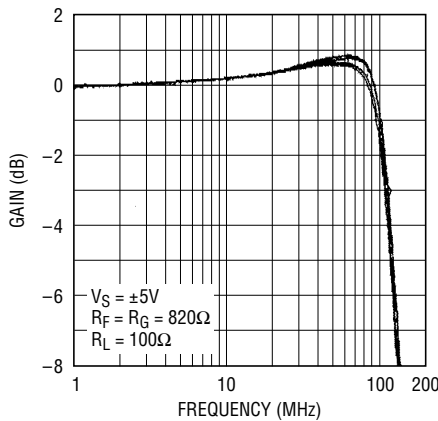

LT1203/05 • A108

4 × 4 Crosspoint, All Hostile Rejection

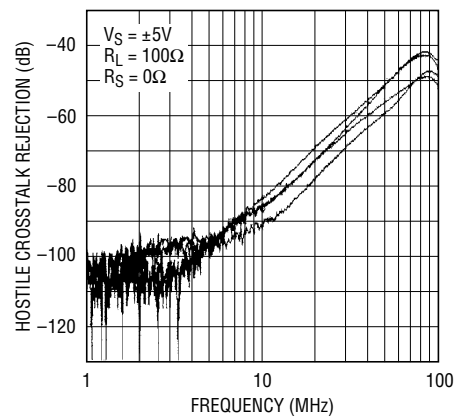

LT1203/05 • A109

4 × 4 Crosspoint, Switching Channel 0 to Channel 2

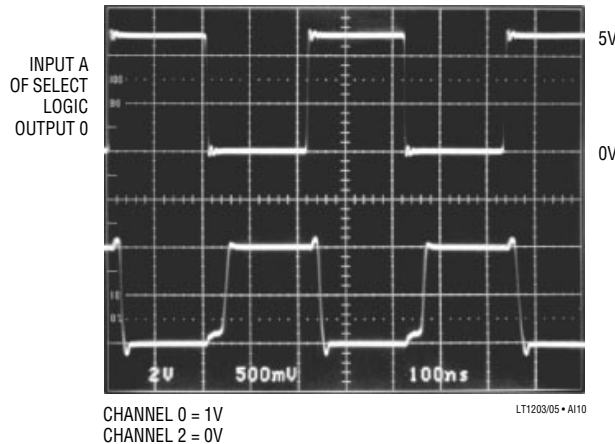

LT1203/05 • A110

SIMPLIFIED SCHEMATIC

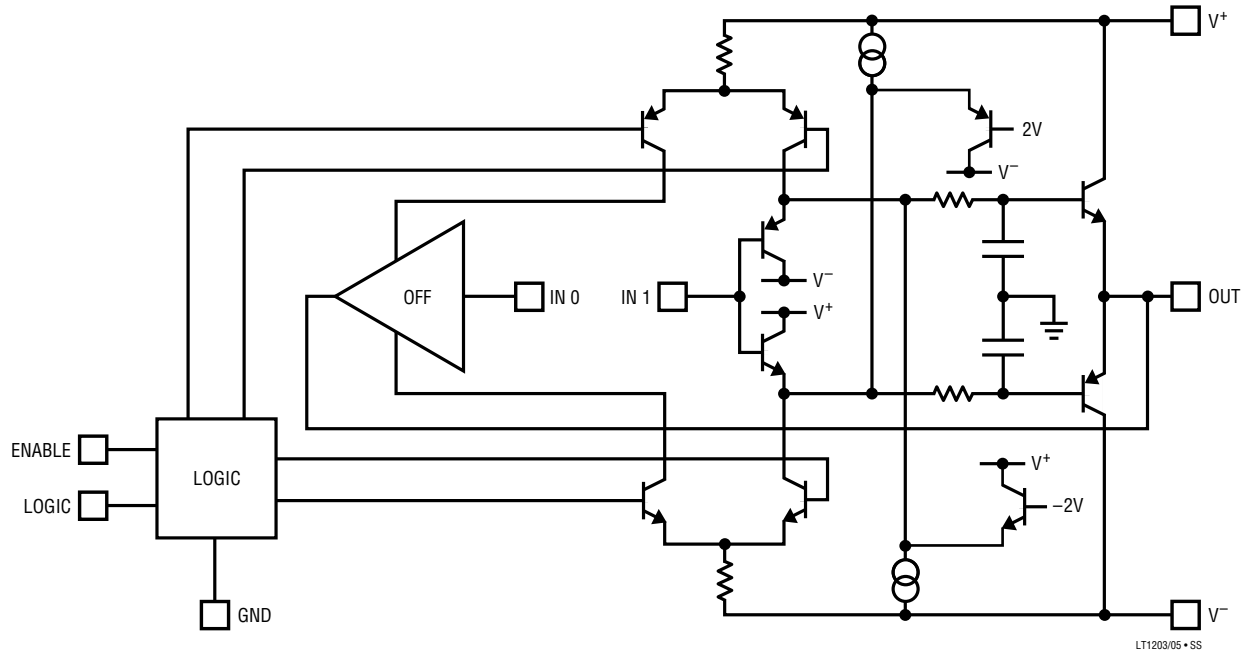

PACKAGE DESCRIPTION Dimensions in inches (millimeters) unless otherwise noted.

N8 Package 8-Lead Plastic DIP

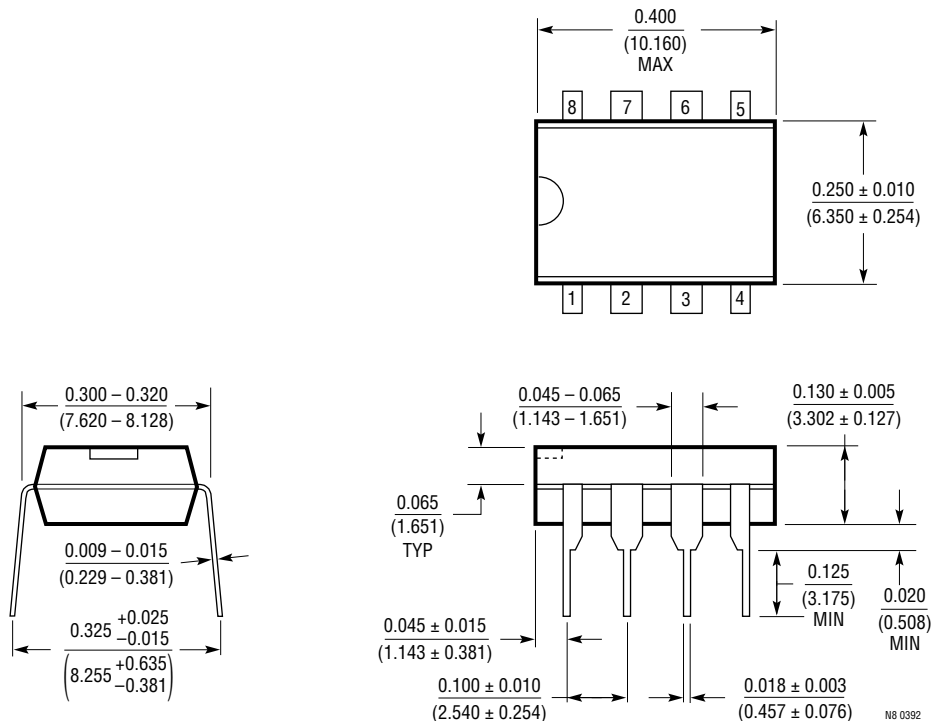

PACKAGE DESCRIPTION Dimensions in inches (millimeters) unless otherwise noted.

**S8 Package
8-Lead Plastic SOIC**

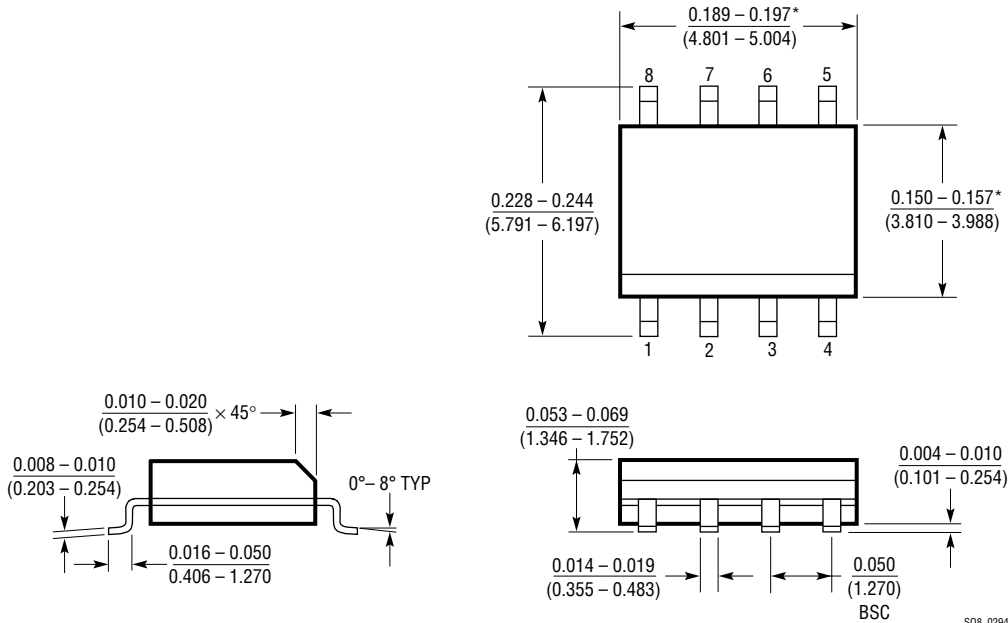

*THESE DIMENSIONS DO NOT INCLUDE MOLD FLASH OR PROTRUSIONS.
MOLD FLASH OR PROTRUSIONS SHALL NOT EXCEED 0.006 INCH (0.15mm).

**S Package
16-Lead Plastic SOIC**

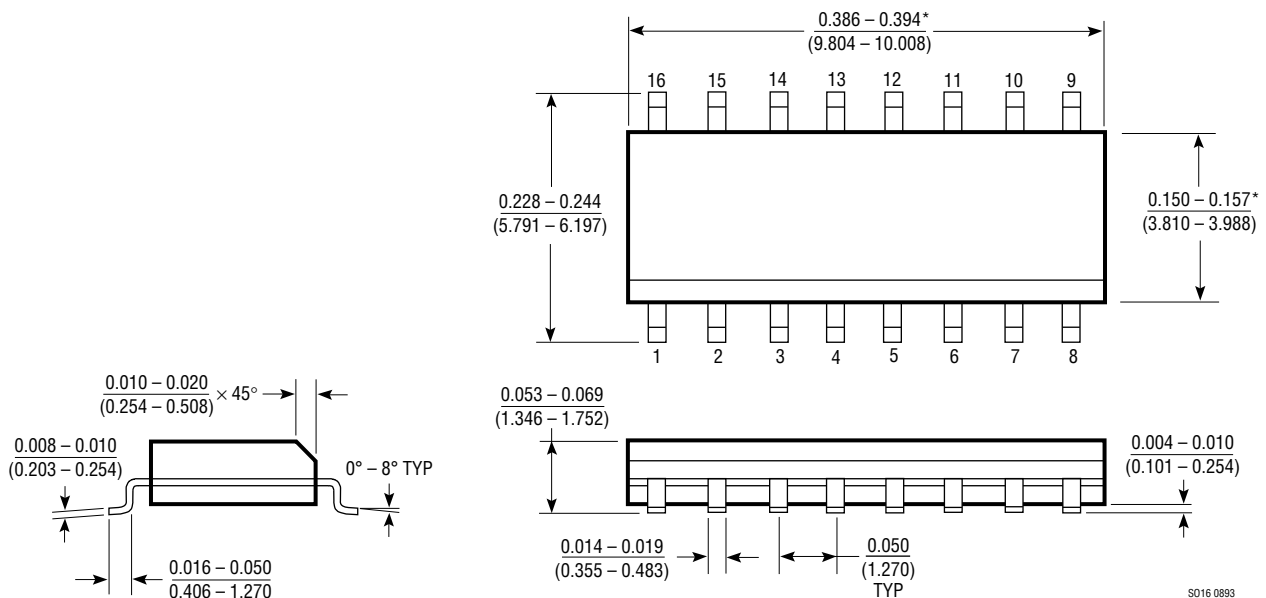

*THESE DIMENSIONS DO NOT INCLUDE MOLD FLASH OR PROTRUSIONS.
MOLD FLASH OR PROTRUSIONS SHALL NOT EXCEED 0.006 INCH (0.15mm).



Стандарт Электрон Связь

Мы молодая и активно развивающаяся компания в области поставок электронных компонентов. Мы поставляем электронные компоненты отечественного и импортного производства напрямую от производителей и с крупнейших складов мира.

Благодаря сотрудничеству с мировыми поставщиками мы осуществляем комплексные и плановые поставки широчайшего спектра электронных компонентов.

Собственная эффективная логистика и склад в обеспечивает надежную поставку продукции в точно указанные сроки по всей России.

Мы осуществляем техническую поддержку нашим клиентам и предпродажную проверку качества продукции. На все поставляемые продукты мы предоставляем гарантию .

Осуществляем поставки продукции под контролем ВП МО РФ на предприятия военно-промышленного комплекса России , а также работаем в рамках 275 ФЗ с открытием отдельных счетов в уполномоченном банке. Система менеджмента качества компании соответствует требованиям ГОСТ ISO 9001.

Минимальные сроки поставки, гибкие цены, неограниченный ассортимент и индивидуальный подход к клиентам являются основой для выстраивания долгосрочного и эффективного сотрудничества с предприятиями радиоэлектронной промышленности, предприятиями ВПК и научно-исследовательскими институтами России.

С нами вы становитесь еще успешнее!

Наши контакты:

Телефон: +7 812 627 14 35

Электронная почта: sales@st-electron.ru

Адрес: 198099, Санкт-Петербург,
Промышленная ул, дом № 19, литера Н,
помещение 100-Н Офис 331