

# BC847/BC547 series

45 V, 100 mA NPN general-purpose transistors

Rev. 07 — 10 December 2008

Product data sheet

## 1. Product profile

### 1.1 General description

NPN general-purpose transistors in small plastic packages.

Table 1. Product overview

Type number <sup>[1]</sup>	Package			PNP complement
	NXP	JEITA	JEDEC	
BC847	SOT23	-	TO-236AB	BC857
BC847A				BC857A
BC847B				BC857B
BC847B/DG				-
BC847C				BC857C
BC847W	SOT323	SC-70	-	BC857W
BC847AW				BC857AW
BC847BW				BC857BW
BC847BW/DG				-
BC847CW				BC857CW
BC847T	SOT416	SC-75	-	BC857T
BC847AT				BC857AT
BC847AT/DG				-
BC847BT				BC857BT
BC847CT				BC857CT
BC847AM	SOT883	SC-101	-	BC857AM
BC847BM				BC857BM
BC847CM				BC857CM
BC547 <sup>[2]</sup>	SOT54	SC-43A	TO-92	BC557 <sup>[2]</sup>
BC547B <sup>[2]</sup>				BC557B <sup>[2]</sup>
BC547C <sup>[2]</sup>				BC557C <sup>[2]</sup>

[1] /DG: halogen-free

[2] Also available in SOT54A and SOT54 variant packages (see [Section 2](#)).

## 1.2 Features

- Low current
- Low voltage
- Three different gain selections

## 1.3 Applications

- General-purpose switching and amplification

## 1.4 Quick reference data

**Table 2. Quick reference data**

Symbol	Parameter	Conditions	Min	Typ	Max	Unit
$V_{CE0}$	collector-emitter voltage	open base	-	-	45	V
$I_C$	collector current		-	-	100	mA
$h_{FE}$	DC current gain	$V_{CE} = 5\text{ V}; I_C = 2\text{ mA}$	110	-	800	
	$h_{FE}$ group A		110	180	220	
	$h_{FE}$ group B		200	290	450	
	$h_{FE}$ group C		420	520	800	

## 2. Pinning information

**Table 3. Pinning**

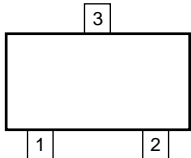
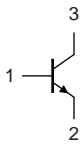
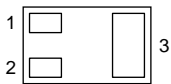
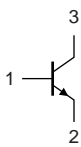
Pin	Description	Simplified outline	Graphic symbol
<b>SOT23, SOT323, SOT416</b>			
1	base	 <p>006aaa144</p>	 <p>sym021</p>
2	emitter		
3	collector		
<b>SOT883</b>			
1	base	 <p>Transparent top view</p>	 <p>sym021</p>
2	emitter		
3	collector		

**Table 3. Pinning ...continued**

Pin	Description	Simplified outline	Graphic symbol
<b>SOT54</b>			
1	emitter	<p>001aab347</p>	<p>sym026</p>
2	base		
3	collector		
<b>SOT54A</b>			
1	emitter	<p>001aab348</p>	<p>sym026</p>
2	base		
3	collector		
<b>SOT54 variant</b>			
1	emitter	<p>001aab447</p>	<p>sym026</p>
2	base		
3	collector		

### 3. Ordering information

**Table 4. Ordering information**

Type number <sup>[1]</sup>	Package		Version
	Name	Description	
BC847	-	plastic surface-mounted package; 3 leads	SOT23
BC847A			
BC847B			
BC847B/DG			
BC847C			
BC847W	SC-70	plastic surface-mounted package; 3 leads	SOT323
BC847AW			
BC847BW			
BC847BW/DG			
BC847CW			

Table 4. Ordering information ...continued

Type number <sup>[1]</sup>	Package		
	Name	Description	Version
BC847T	SC-75	plastic surface-mounted package; 3 leads	SOT416
BC847AT			
BC847AT/DG			
BC847BT			
BC847CT			
BC847AM	SC-101	leadless ultra small plastic package; 3 solder lands; body 1.0 × 0.6 × 0.5 mm	SOT883
BC847BM			
BC847CM			
BC547 <sup>[2]</sup>	SC-43A	plastic single-ended leaded (through hole) package; 3 leads	SOT54
BC547B <sup>[2]</sup>			
BC547C <sup>[2]</sup>			

[1] /DG: halogen-free

[2] Also available in SOT54 and SOT54 variant packages (see [Section 2](#) and [Section 9](#)).

## 4. Marking

Table 5. Marking codes

Type number <sup>[1]</sup>	Marking code <sup>[2]</sup>	Type number <sup>[1]</sup>	Marking code <sup>[2]</sup>
BC847	1H*	BC847AT	1E
BC847A	1E*	BC847AT/DG	B5
BC847B	1F*	BC847BT	1F
BC847B/DG	*BC	BC847CT	1G
BC847C	1G*	BC847AM	D4
BC847W	1H*	BC847BM	D5
BC847AW	1E*	BC847CM	D6
BC847BW	1F*	BC547	C547
BC847BW/DG	G9*	BC547B	C547B
BC847CW	1G*	BC547C	C547C
BC847T	1N	-	-

[1] /DG: halogen-free

[2] \* = -: made in Hong Kong

\* = p: made in Hong Kong

\* = t: made in Malaysia

\* = W: made in China

## 5. Limiting values

**Table 6. Limiting values**

In accordance with the Absolute Maximum Rating System (IEC 60134).

Symbol	Parameter	Conditions	Min	Max	Unit
$V_{CBO}$	collector-base voltage	open emitter	-	50	V
$V_{CEO}$	collector-emitter voltage	open base	-	45	V
$V_{EBO}$	emitter-base voltage	open collector	-	6	V
$I_C$	collector current		-	100	mA
$I_{CM}$	peak collector current	single pulse; $t_p \leq 1$ ms	-	200	mA
$I_{BM}$	peak base current	single pulse; $t_p \leq 1$ ms	-	100	mA
$P_{tot}$	total power dissipation	$T_{amb} \leq 25$ °C			
	SOT23		[1] -	250	mW
	SOT323		[1] -	200	mW
	SOT416		[1] -	150	mW
	SOT883		[2][3] -	250	mW
	SOT54		[1] -	500	mW
$T_j$	junction temperature		-	150	°C
$T_{amb}$	ambient temperature		-65	+150	°C
$T_{stg}$	storage temperature		-65	+150	°C

[1] Device mounted on an FR4 Printed-Circuit Board (PCB), single-sided copper, tin-plated and standard footprint.

[2] Reflow soldering is the only recommended soldering method.

[3] Device mounted on an FR4 PCB with 60 µm copper strip line, standard footprint.

## 6. Thermal characteristics

**Table 7. Thermal characteristics**

Symbol	Parameter	Conditions	Min	Typ	Max	Unit
$R_{th(j-a)}$	thermal resistance from junction to ambient	in free air				
	SOT23		[1] -	-	500	K/W
	SOT323		[1] -	-	625	K/W
	SOT416		[1] -	-	833	K/W
	SOT883		[2][3] -	-	500	K/W
	SOT54		[1] -	-	250	K/W

[1] Device mounted on an FR4 PCB, single-sided copper, tin-plated and standard footprint.

[2] Reflow soldering is the only recommended soldering method.

[3] Device mounted on an FR4 PCB with 60 µm copper strip line, standard footprint.

## 7. Characteristics

**Table 8. Characteristics**
*T<sub>amb</sub> = 25 °C unless otherwise specified.*

Symbol	Parameter	Conditions	Min	Typ	Max	Unit	
I <sub>CBO</sub>	collector-base cut-off current	V <sub>CB</sub> = 30 V; I <sub>E</sub> = 0 A	-	-	15	nA	
		V <sub>CB</sub> = 30 V; I <sub>E</sub> = 0 A; T <sub>j</sub> = 150 °C	-	-	5	μA	
I <sub>EBO</sub>	emitter-base cut-off current	V <sub>EB</sub> = 5 V; I <sub>C</sub> = 0 A	-	-	100	nA	
h <sub>FE</sub>	DC current gain						
	h <sub>FE</sub> group A	V <sub>CE</sub> = 5 V; I <sub>C</sub> = 10 μA	-	90	-		
	h <sub>FE</sub> group B	V <sub>CE</sub> = 5 V; I <sub>C</sub> = 10 μA	-	150	-		
	h <sub>FE</sub> group C	V <sub>CE</sub> = 5 V; I <sub>C</sub> = 10 μA	-	270	-		
	DC current gain	V <sub>CE</sub> = 5 V; I <sub>C</sub> = 2 mA	110	-	800		
	h <sub>FE</sub> group A	V <sub>CE</sub> = 5 V; I <sub>C</sub> = 2 mA	110	180	220		
	h <sub>FE</sub> group B	V <sub>CE</sub> = 5 V; I <sub>C</sub> = 2 mA	200	290	450		
h <sub>FE</sub> group C	V <sub>CE</sub> = 5 V; I <sub>C</sub> = 2 mA	420	520	800			
V <sub>CEsat</sub>	collector-emitter saturation voltage	I <sub>C</sub> = 10 mA; I <sub>B</sub> = 0.5 mA	-	90	200	mV	
		I <sub>C</sub> = 100 mA; I <sub>B</sub> = 5 mA	[1]	200	400	mV	
V <sub>BEsat</sub>	base-emitter saturation voltage	I <sub>C</sub> = 10 mA; I <sub>B</sub> = 0.5 mA	[2]	700	-	mV	
		I <sub>C</sub> = 100 mA; I <sub>B</sub> = 5 mA	[2]	900	-	mV	
V <sub>BE</sub>	base-emitter voltage	I <sub>C</sub> = 2 mA; V <sub>CE</sub> = 5 V	[2]	580	660	700	mV
		I <sub>C</sub> = 10 mA; V <sub>CE</sub> = 5 V	-	-	770	mV	
C <sub>C</sub>	collector capacitance	I <sub>E</sub> = I <sub>e</sub> = 0 A; V <sub>CB</sub> = 10 V; f = 1 MHz	-	-	1.5	pF	
C <sub>e</sub>	emitter capacitance	I <sub>C</sub> = I <sub>c</sub> = 0 A; V <sub>EB</sub> = 0.5 V; f = 1 MHz	-	11	-	pF	
f <sub>T</sub>	transition frequency	I <sub>C</sub> = 10 mA; V <sub>CE</sub> = 5 V; f = 100 MHz	100	-	-	MHz	
NF	noise figure	I <sub>C</sub> = 200 μA; V <sub>CE</sub> = 5 V; R <sub>S</sub> = 2 kΩ; f = 1 kHz; B = 200 Hz	-	2	10	dB	

[1] Pulse test: t<sub>p</sub> ≤ 300 μs; δ ≤ 0.02.

[2] V<sub>BE</sub> decreases by approximately 2 mV/K with increasing temperature.



$V_{CE} = 5\text{ V}$   
 (1)  $T_{amb} = 150\text{ °C}$   
 (2)  $T_{amb} = 25\text{ °C}$   
 (3)  $T_{amb} = -55\text{ °C}$

**Fig 1. Selection A: DC current gain as a function of collector current; typical values**

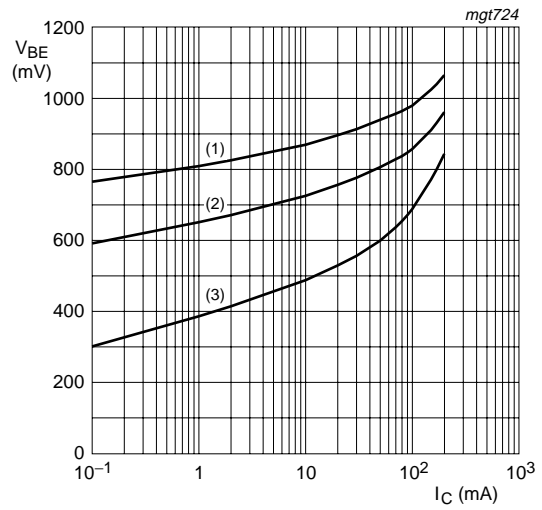

$V_{CE} = 5\text{ V}$   
 (1)  $T_{amb} = -55\text{ °C}$   
 (2)  $T_{amb} = 25\text{ °C}$   
 (3)  $T_{amb} = 150\text{ °C}$

**Fig 2. Selection A: Base-emitter voltage as a function of collector current; typical values**



$I_C/I_B = 20$   
 (1)  $T_{amb} = 150\text{ °C}$   
 (2)  $T_{amb} = 25\text{ °C}$   
 (3)  $T_{amb} = -55\text{ °C}$

**Fig 3. Selection A: Collector-emitter saturation voltage as a function of collector current; typical values**

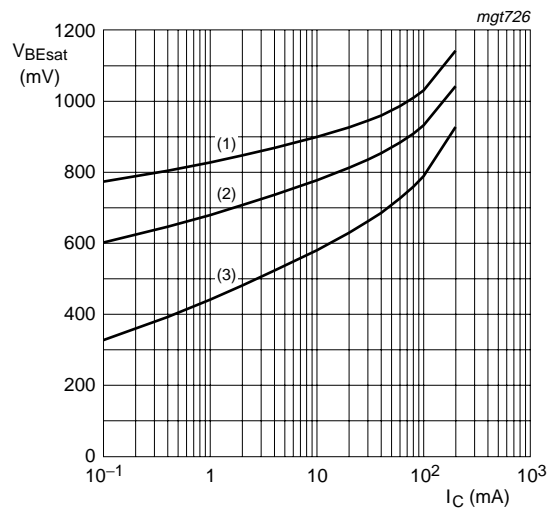

$I_C/I_B = 10$   
 (1)  $T_{amb} = -55\text{ °C}$   
 (2)  $T_{amb} = 25\text{ °C}$   
 (3)  $T_{amb} = 150\text{ °C}$

**Fig 4. Selection A: Base-emitter saturation voltage as a function of collector current; typical values**



$V_{CE} = 5\text{ V}$   
 (1)  $T_{amb} = 150\text{ °C}$   
 (2)  $T_{amb} = 25\text{ °C}$   
 (3)  $T_{amb} = -55\text{ °C}$

**Fig 5. Selection B: DC current gain as a function of collector current; typical values**



$V_{CE} = 5\text{ V}$   
 (1)  $T_{amb} = -55\text{ °C}$   
 (2)  $T_{amb} = 25\text{ °C}$   
 (3)  $T_{amb} = 150\text{ °C}$

**Fig 6. Selection B: Base-emitter voltage as a function of collector current; typical values**



$I_C/I_B = 20$   
 (1)  $T_{amb} = 150\text{ °C}$   
 (2)  $T_{amb} = 25\text{ °C}$   
 (3)  $T_{amb} = -55\text{ °C}$

**Fig 7. Selection B: Collector-emitter saturation voltage as a function of collector current; typical values**

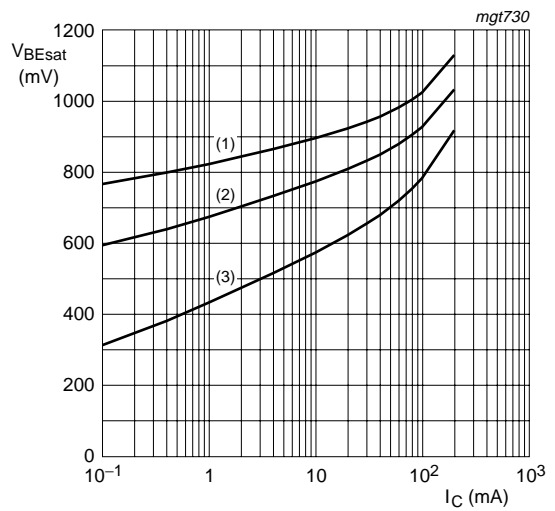

$I_C/I_B = 10$   
 (1)  $T_{amb} = -55\text{ °C}$   
 (2)  $T_{amb} = 25\text{ °C}$   
 (3)  $T_{amb} = 150\text{ °C}$

**Fig 8. Selection B: Base-emitter saturation voltage as a function of collector current; typical values**





$V_{CE} = 5\text{ V}$   
 (1)  $T_{amb} = 150\text{ °C}$   
 (2)  $T_{amb} = 25\text{ °C}$   
 (3)  $T_{amb} = -55\text{ °C}$

**Fig 9. Selection C: DC current gain as a function of collector current; typical values**



$V_{CE} = 5\text{ V}$   
 (1)  $T_{amb} = -55\text{ °C}$   
 (2)  $T_{amb} = 25\text{ °C}$   
 (3)  $T_{amb} = 150\text{ °C}$

**Fig 10. Selection C: Base-emitter voltage as a function of collector current; typical values**



$I_C/I_B = 20$   
 (1)  $T_{amb} = 150\text{ °C}$   
 (2)  $T_{amb} = 25\text{ °C}$   
 (3)  $T_{amb} = -55\text{ °C}$

**Fig 11. Selection C: Collector-emitter saturation voltage as a function of collector current; typical values**

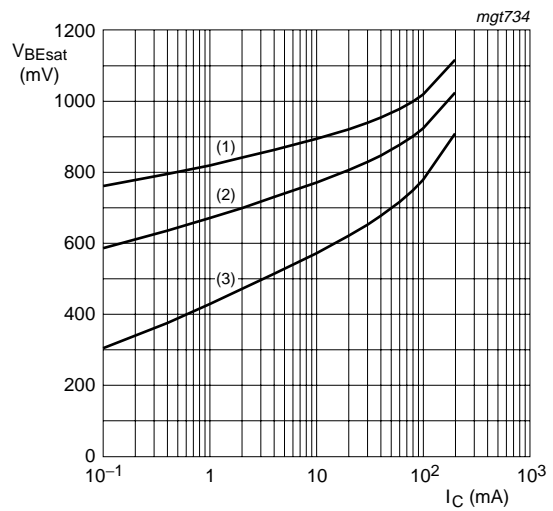

$I_C/I_B = 10$   
 (1)  $T_{amb} = -55\text{ °C}$   
 (2)  $T_{amb} = 25\text{ °C}$   
 (3)  $T_{amb} = 150\text{ °C}$

**Fig 12. Selection C: Base-emitter saturation voltage as a function of collector current; typical values**

**8. Package outline**

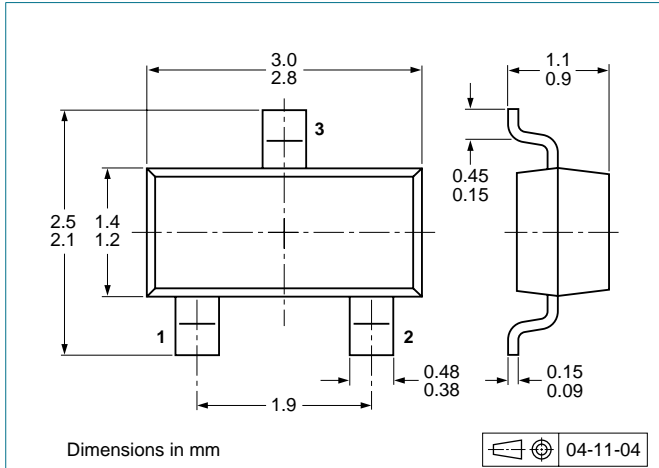

**Fig 13. Package outline SOT23 (TO-236AB)**

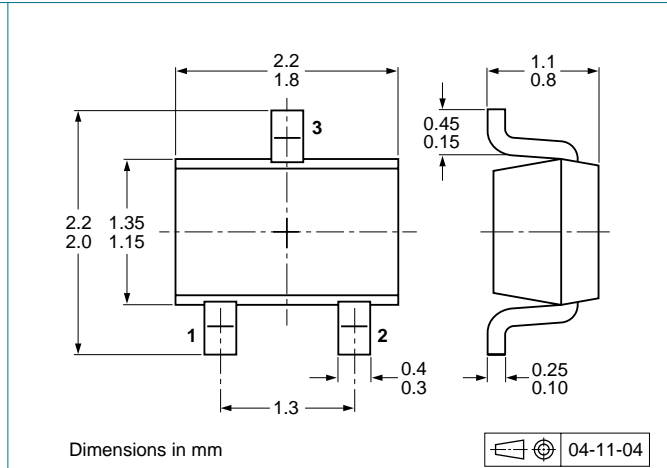

**Fig 14. Package outline SOT323 (SC-70)**

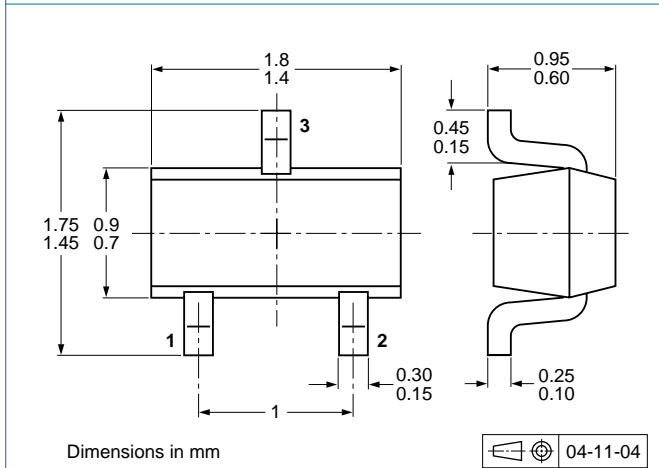

**Fig 15. Package outline SOT416 (SC-75)**

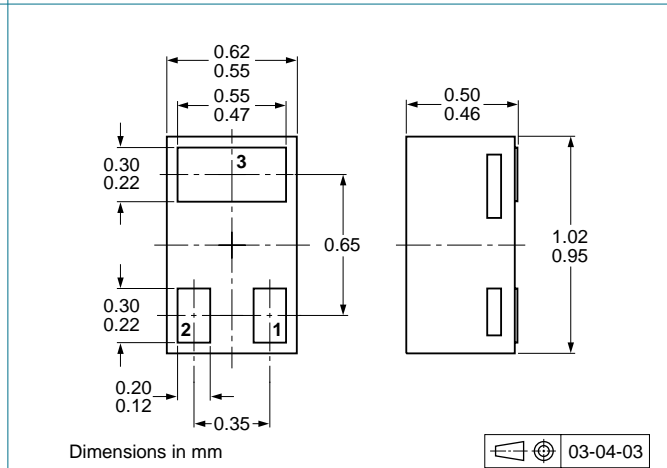

**Fig 16. Package outline SOT883 (SC-101)**

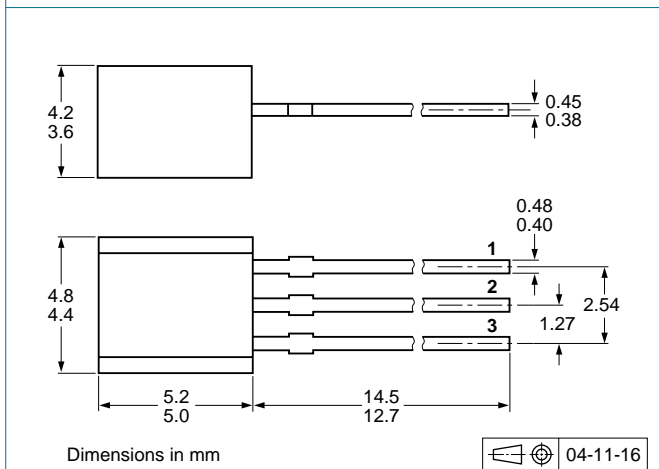

**Fig 17. Package outline SOT54 (SC-43A/TO-92)**

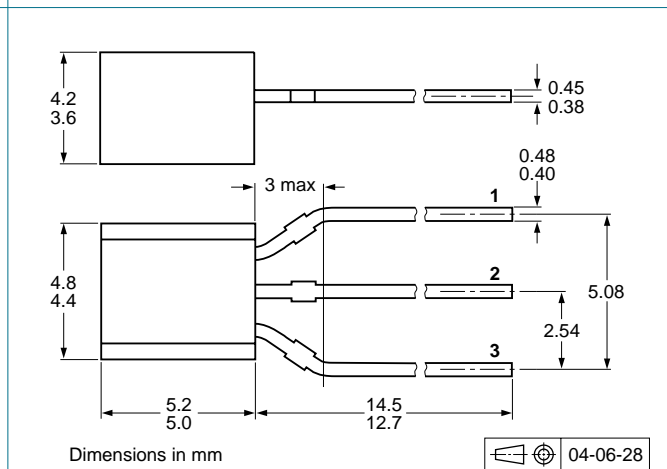

**Fig 18. Package outline SOT54A**

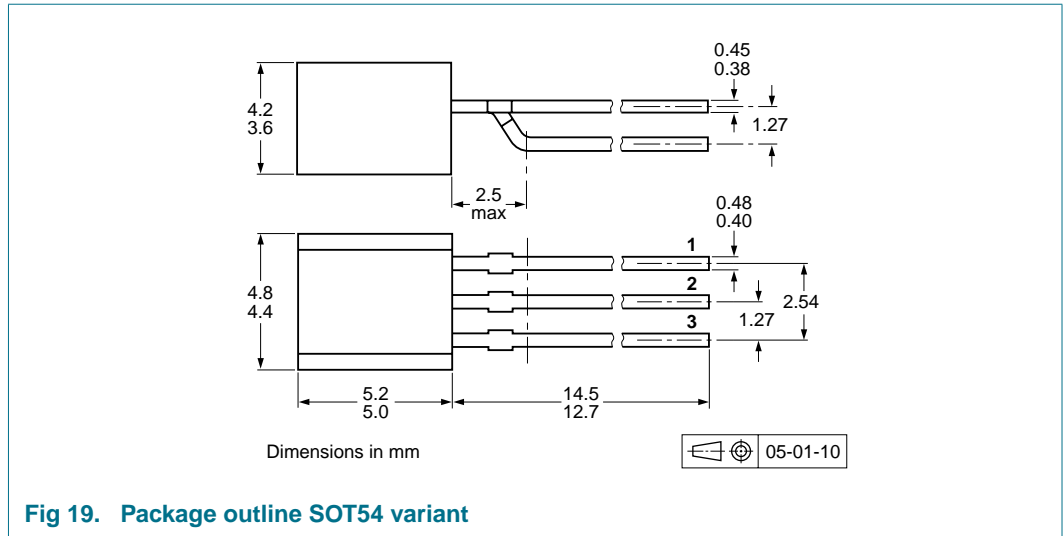

Fig 19. Package outline SOT54 variant

## 9. Packing information

**Table 9. Packing methods**

The indicated -xxx are the last three digits of the 12NC ordering code.<sup>[1]</sup>

Type number <sup>[2]</sup>	Package	Description	Packing quantity		
			3000	5000	10000
BC847	SOT23	4 mm pitch, 8 mm tape and reel	-215	-	-235
BC847A					
BC847B					
BC847B/DG					
BC847C					
BC847W	SOT323	4 mm pitch, 8 mm tape and reel	-115	-	-135
BC847AW					
BC847BW					
BC847BW/DG					
BC847CW					
BC847T	SOT416	4 mm pitch, 8 mm tape and reel	-115	-	-135
BC847AT					
BC847AT/DG					
BC847BT					
BC847CT					
BC847AM	SOT883	2 mm pitch, 8 mm tape and reel	-	-	-315
BC847BM					
BC847CM					
BC547	SOT54	bulk, straight leads	-	-412	-
BC547B					
BC547C					

**Table 9. Packing methods ...continued**

The indicated -xxx are the last three digits of the 12NC ordering code.<sup>[1]</sup>

Type number <sup>[2]</sup>	Package	Description	Packing quantity		
			3000	5000	10000
BC547 BC547B BC547C	SOT54A	tape and reel, wide pitch	-	-	-116
BC547 BC547B BC547C	SOT54A	tape ammopack, wide pitch	-	-	-126
BC547 BC547B BC547C	SOT54 variant	bulk, delta pinning	-	-112	-

[1] For further information and the availability of packing methods, see [Section 12](#).

[2] /DG: halogen-free

## 10. Revision history

**Table 10. Revision history**

Document ID	Release date	Data sheet status	Change notice	Supersedes
BC847_BC547_SER_7	20081210	Product data sheet	-	BC847_BC547_SER_6
Modifications:				
				<ul style="list-style-type: none"> <li>The format of this data sheet has been redesigned to comply with the new identity guidelines of NXP Semiconductors.</li> <li>Legal texts have been adapted to the new company name where appropriate.</li> <li><a href="#">Table 1 "Product overview"</a>: enhanced</li> <li><a href="#">Table 4 "Ordering information"</a>: enhanced</li> <li><a href="#">Table 5 "Marking codes"</a>: enhanced</li> <li><a href="#">Table 6 "Limiting values"</a>: I<sub>EBO</sub> conditions amended</li> <li><a href="#">Table 8 "Characteristics"</a>: symbol N for parameter noise figure redefined to NF</li> <li><a href="#">Table 9 "Packing methods"</a>: enhanced</li> <li><a href="#">Section 11 "Legal information"</a>: updated</li> </ul>
BC847_BC547_SER_6	20050519	Product data sheet	-	BC846_BC847_BC848_5, BC847M_SERIES_2, BC846T_847T_SERIES_3, BC846W_BC847W_BC848W_4, BC546_547_4
BC846_BC847_BC848_5	20040206	Product specification	-	BC846_BC847_BC848_4
BC847M_SERIES_2	20040310	Product specification	-	BC847M_SERIES_1
BC846T_847T_SERIES_3	20001115	Product specification	-	BC846T_847T_2
BC846W_BC847W_ BC848W_4	20020204	Product specification	-	BC846W_847W_3
BC546_547_4	20041125	Product specification	-	BC546_547_3

## 11. Legal information

### 11.1 Data sheet status

Document status <sup>[1][2]</sup>	Product status <sup>[3]</sup>	Definition
Objective [short] data sheet	Development	This document contains data from the objective specification for product development.
Preliminary [short] data sheet	Qualification	This document contains data from the preliminary specification.
Product [short] data sheet	Production	This document contains the product specification.

[1] Please consult the most recently issued document before initiating or completing a design.

[2] The term 'short data sheet' is explained in section "Definitions".

[3] The product status of device(s) described in this document may have changed since this document was published and may differ in case of multiple devices. The latest product status information is available on the Internet at URL <http://www.nxp.com>.

### 11.2 Definitions

**Draft** — The document is a draft version only. The content is still under internal review and subject to formal approval, which may result in modifications or additions. NXP Semiconductors does not give any representations or warranties as to the accuracy or completeness of information included herein and shall have no liability for the consequences of use of such information.

**Short data sheet** — A short data sheet is an extract from a full data sheet with the same product type number(s) and title. A short data sheet is intended for quick reference only and should not be relied upon to contain detailed and full information. For detailed and full information see the relevant full data sheet, which is available on request via the local NXP Semiconductors sales office. In case of any inconsistency or conflict with the short data sheet, the full data sheet shall prevail.

### 11.3 Disclaimers

**General** — Information in this document is believed to be accurate and reliable. However, NXP Semiconductors does not give any representations or warranties, expressed or implied, as to the accuracy or completeness of such information and shall have no liability for the consequences of use of such information.

**Right to make changes** — NXP Semiconductors reserves the right to make changes to information published in this document, including without limitation specifications and product descriptions, at any time and without notice. This document supersedes and replaces all information supplied prior to the publication hereof.

**Suitability for use** — NXP Semiconductors products are not designed, authorized or warranted to be suitable for use in medical, military, aircraft, space or life support equipment, nor in applications where failure or malfunction of an NXP Semiconductors product can reasonably be expected to result in personal injury, death or severe property or environmental

damage. NXP Semiconductors accepts no liability for inclusion and/or use of NXP Semiconductors products in such equipment or applications and therefore such inclusion and/or use is at the customer's own risk.

**Applications** — Applications that are described herein for any of these products are for illustrative purposes only. NXP Semiconductors makes no representation or warranty that such applications will be suitable for the specified use without further testing or modification.

**Limiting values** — Stress above one or more limiting values (as defined in the Absolute Maximum Ratings System of IEC 60134) may cause permanent damage to the device. Limiting values are stress ratings only and operation of the device at these or any other conditions above those given in the Characteristics sections of this document is not implied. Exposure to limiting values for extended periods may affect device reliability.

**Terms and conditions of sale** — NXP Semiconductors products are sold subject to the general terms and conditions of commercial sale, as published at <http://www.nxp.com/profile/terms>, including those pertaining to warranty, intellectual property rights infringement and limitation of liability, unless explicitly otherwise agreed to in writing by NXP Semiconductors. In case of any inconsistency or conflict between information in this document and such terms and conditions, the latter will prevail.

**No offer to sell or license** — Nothing in this document may be interpreted or construed as an offer to sell products that is open for acceptance or the grant, conveyance or implication of any license under any copyrights, patents or other industrial or intellectual property rights.

**Quick reference data** — The Quick reference data is an extract of the product data given in the Limiting values and Characteristics sections of this document, and as such is not complete, exhaustive or legally binding.

### 11.4 Trademarks

Notice: All referenced brands, product names, service names and trademarks are the property of their respective owners.

## 12. Contact information

For more information, please visit: <http://www.nxp.com>

For sales office addresses, please send an email to: [salesaddresses@nxp.com](mailto:salesaddresses@nxp.com)

**13. Contents**

**1 Product profile . . . . . 1**

1.1 General description . . . . . 1

1.2 Features . . . . . 2

1.3 Applications . . . . . 2

1.4 Quick reference data . . . . . 2

**2 Pinning information . . . . . 2**

**3 Ordering information . . . . . 3**

**4 Marking . . . . . 4**

**5 Limiting values . . . . . 5**

**6 Thermal characteristics . . . . . 5**

**7 Characteristics . . . . . 6**

**8 Package outline . . . . . 10**

**9 Packing information . . . . . 11**

**10 Revision history . . . . . 13**

**11 Legal information . . . . . 14**

11.1 Data sheet status . . . . . 14

11.2 Definitions . . . . . 14

11.3 Disclaimers . . . . . 14

11.4 Trademarks . . . . . 14

**12 Contact information . . . . . 14**

**13 Contents . . . . . 15**

Please be aware that important notices concerning this document and the product(s) described herein, have been included in section 'Legal information'.



© NXP B.V. 2008.

All rights reserved.

For more information, please visit: <http://www.nxp.com>

For sales office addresses, please send an email to: [salesaddresses@nxp.com](mailto:salesaddresses@nxp.com)

Date of release: 10 December 2008

Document identifier: BC847\_BC547\_SER\_7



## Стандарт Электрон Связь

Мы молодая и активно развивающаяся компания в области поставок электронных компонентов. Мы поставляем электронные компоненты отечественного и импортного производства напрямую от производителей и с крупнейших складов мира.

Благодаря сотрудничеству с мировыми поставщиками мы осуществляем комплексные и плановые поставки широчайшего спектра электронных компонентов.

Собственная эффективная логистика и склад в обеспечивает надежную поставку продукции в точно указанные сроки по всей России.

Мы осуществляем техническую поддержку нашим клиентам и предпродажную проверку качества продукции. На все поставляемые продукты мы предоставляем гарантию .

Осуществляем поставки продукции под контролем ВП МО РФ на предприятия военно-промышленного комплекса России , а также работаем в рамках 275 ФЗ с открытием отдельных счетов в уполномоченном банке. Система менеджмента качества компании соответствует требованиям ГОСТ ISO 9001.

Минимальные сроки поставки, гибкие цены, неограниченный ассортимент и индивидуальный подход к клиентам являются основой для выстраивания долгосрочного и эффективного сотрудничества с предприятиями радиоэлектронной промышленности, предприятиями ВПК и научно-исследовательскими институтами России.

С нами вы становитесь еще успешнее!

### Наши контакты:

**Телефон:** +7 812 627 14 35

**Электронная почта:** [sales@st-electron.ru](mailto:sales@st-electron.ru)

**Адрес:** 198099, Санкт-Петербург,  
Промышленная ул, дом № 19, литера Н,  
помещение 100-Н Офис 331