



## 50 mΩ, Slew Rate Controlled Load Switch in WCSP

### DESCRIPTION

The SiP32467 and SiP32468 are slew rate controlled integrated high side load switches that operate in the input voltage range from 1.2 V to 5.5 V.

This series of design features slew rate control, reverse blocking when switch is off, output discharge, and control logic pull up. The devices are logic low enabled.

The SiP32467 and SiP32468 are available in compact wafer level WCSP package, WCSP4 0.76 mm x 0.76 mm with 0.4 mm pitch.

### FEATURES

- Low input voltage, 1.2 V to 5.5 V
- Low  $R_{on}$ , 54 mΩ/typ. at 3 V
- Slew rate control
- Compatible with 1.2 V to 3.3 V logic
- Reverse current blocking when switch is off
- Integrated output discharge switch (SiP32468)
- Integrated pull up resistor at "EN"
- For enable "High" see SiP32460, SiP32461, and SiP32462
- 4-bump WCSP package
- Material categorization: For definitions of compliance please see [www.vishay.com/doc?99912](http://www.vishay.com/doc?99912)



### APPLICATIONS

- Smart phones
- GPS and portable media players
- Tablet computers
- Medical and healthcare equipment
- Industrial and instrumentation
- Game consoles

### TYPICAL APPLICATION CIRCUIT

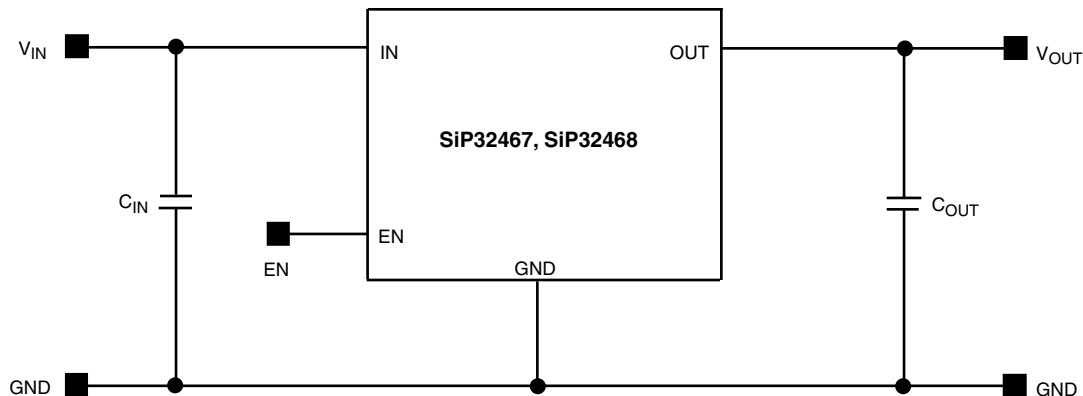


Fig. 1 - Typical Application Circuit

ORDERING INFORMATION					
PART NUMBER	PACKAGE	$t_{on}$ ( $\mu s$ )	$R_{DISCHARGE}$	MARK CODE	TEMPERATURE RANGE
SiP32467DB-T2-GE1	WCSP4 (2x2) 0.4 mm Pitch	300	No	AJ	-40 °C to +85 °C
SiP32468DB-T2-GE1	WCSP4 (2x2) 0.4 mm Pitch	300	Yes	AK	-40 °C to +85 °C

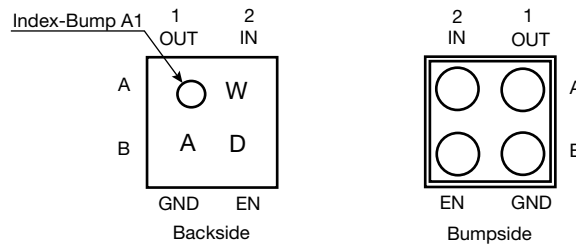
**PIN CONFIGURATION**


Fig. 2 - WCSP 2 x 2 Package

DEVICE MARKING		
Row 1	<b>Dot + W</b>	: Dot is A1 locator plus week code
Row 2	<b>AB</b>	: Mark code for part number
SiP32467 = AJ		
SiP32468 = AK		

PIN DESCRIPTION (WSCP Package)		
PIN#	NAME	FUNCTION
A1	OUT	Switch output
A2	IN	Switch input
B1	GND	Ground connection
B2	EN	Switch on/off control. A pull up resistor is integrated

TRUTH TABLE	
EN	SWITCH
1	OFF
0	ON



ABSOLUTE MAXIMUM RATINGS			
PARAMETER	CONDITIONS	LIMIT	UNIT
Supply Input Voltage $V_{IN}$	Reference to GND	-0.3 to 6.5	V
Output Voltage $V_{OUT}$	Reference to GND	-0.3 to 6.5	
Output Voltage $V_{OUT}$	Pulse at 1 ms reference to GND <sup>(1)</sup>	-1.6	
Enable Input Voltage EN	Reference to GND	-0.3 to 6.5	
Maximum Continuous Switch Current		1.2	A
Maximum Pulse Switch Current	Pulse at 1 ms, 10 % duty cycle	2	
ESD Rating (HBM)		4000	V
Thermal Resistance		205	°C/W
Maximum Power Dissipation	$T_A = 25\text{ °C}$	300	mW
TEMPERATURE			
Operating Temperature		-40 to 85	°C
Operating Junction Temperature		125	
Storage Temperature		-65 to 150	

**Note**

<sup>(1)</sup> Negative current injection up to 300 mA

Stresses beyond those listed under "Absolute Maximum Ratings" may cause permanent damage to the device. These are stress ratings only, and functional operation of the device at these or any other conditions beyond those indicated in the operational sections of the specifications is not implied. Exposure to absolute maximum rating conditions for extended periods may affect device reliability.

RECOMMENDED OPERATING RANGE				
ELECTRICAL PARAMETER	MINIMUM	TYPICAL	MAXIMUM	UNIT
Input Voltage ( $V_{IN}$ )	1.2	-	5.5	V
Output Voltage ( $V_{OUT}$ )	1.2	-	5.5	

SPECIFICATIONS						
PARAMETER	SYMBOL	TEST CONDITION UNLESS OTHERWISE SPECIFIED $V_{IN} = 1.2\text{ V to }5.5\text{ V}, T_A = -40\text{ °C to }85\text{ °C}$	LIMITS			UNIT
			MIN.	TYP.	MAX.	
POWER SUPPLY						
Quiescent Current	$I_Q$	$V_{IN} = 3.3\text{ V}, I_{OUT} = 0\text{ mA}$	-	6	8	$\mu\text{A}$
Shutdown Current	$I_{SD}$	OUT = GND	-	0.01	2	
Off Switch Current	$I_{DS(off)}$	EN = $V_{IN}$ , OUT = GND	-	0.01	2	
Reverse Blocking Current	$I_{(in)RB}$	Out = 5 V, IN = 1.2 V, EN = 1.2 V, (Measured at IN pin)	-	0.01	1	
		Out = 5 V, IN = 0 V, EN = open, (Measured at IN pin)	-	0.01	1	
SWITCH RESISTANCE						
On Resistance	$R_{DS(on)}$	$I_{OUT} = 500\text{ mA}, V_{IN} = 1.2\text{ V}, T_A = 25\text{ °C}$	-	95	150	m $\Omega$
		$I_{OUT} = 500\text{ mA}, V_{IN} = 1.5\text{ V}, T_A = 25\text{ °C}$	-	80	120	
		$I_{OUT} = 500\text{ mA}, V_{IN} = 1.8\text{ V}, T_A = 25\text{ °C}$	-	70	100	
		$I_{OUT} = 500\text{ mA}, V_{IN} = 3\text{ V}, T_A = 25\text{ °C}$	-	54	65	
		$I_{OUT} = 500\text{ mA}, V_{IN} = 5\text{ V}, T_A = 25\text{ °C}$	-	50	65	
Discharge Switch On Resistance	$R_{PD}$	When $V_{IN} = 3\text{ V}$ at 25 °C	-	80	-	$\Omega$
		When $V_{IN} = 1.8\text{ V}$ at 25 °C	-	< 200	-	
EN Pin Pull Up Resistor	$R_{EN}$	EN = 1.2 V	1	2.6	5	M $\Omega$
On Resistance Temperature Coefficient	$TC_{RDS}$		-	2800		ppm/°C

SPECIFICATIONS						
PARAMETER	SYMBOL	TEST CONDITION UNLESS OTHERWISE SPECIFIED $V_{IN} = 1.2\text{ V to }5.5\text{ V}$ , $T_A = -40\text{ }^\circ\text{C to }85\text{ }^\circ\text{C}$	LIMITS			UNIT
			MIN.	TYP.	MAX.	
<b>ON/OFF LOGIC</b>						
EN Input Low Voltage	$V_{IL}$	$V_{IN} = 1.5\text{ V}$	0.4	-	-	V
EN Input High Voltage	$V_{IH}$	$V_{IN} = 5.5\text{ V}$	-	-	1	
<b>SWITCHING SPEED</b>						
Switch Turn-ON Delay Time	$t_{on\_DLY}$	$R_{LOAD} = 500\ \Omega$ , $C_L = 0.1\ \mu\text{F}$ $V_{IN} = 5\text{ V}$	-	130	-	$\mu\text{s}$
Switch Turn-ON Rise Time	$t_r$	$R_{LOAD} = 500\ \Omega$ , $C_L = 0.1\ \mu\text{F}$ $V_{IN} = 5\text{ V}$	-	170	-	
Switch Turn-OFF Delay Time	$t_{off}$	$R_{LOAD} = 500\ \Omega$ , $C_L = 0.1\ \mu\text{F}$ , (50 % $V_{IN}$ to 90 % $V_{OUT}$ )	-	2	-	

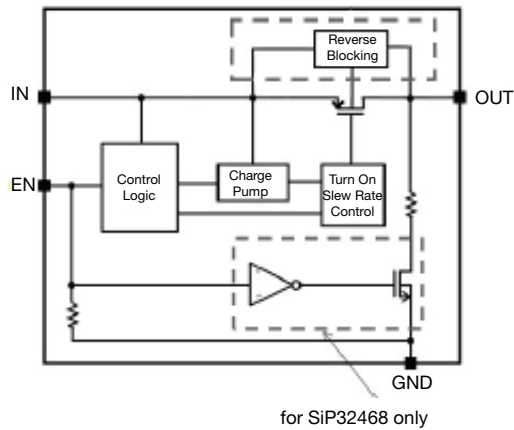
**BLOCK DIAGRAM**


Fig. 3 - Functional Block Diagram



TYPICAL CHARACTERISTICS (T<sub>J</sub> = 25 °C, unless otherwise noted)

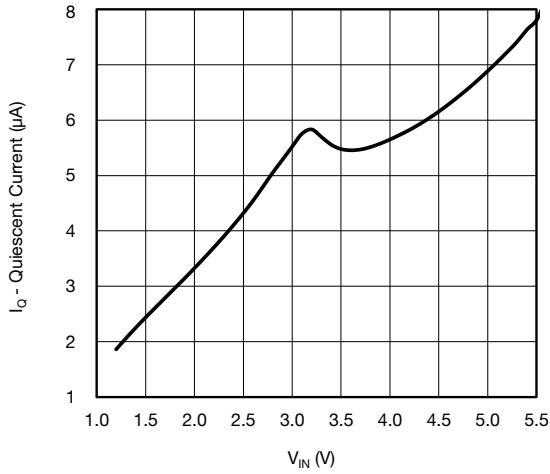


Fig. 4 - Quiescent Current vs. Input Voltage

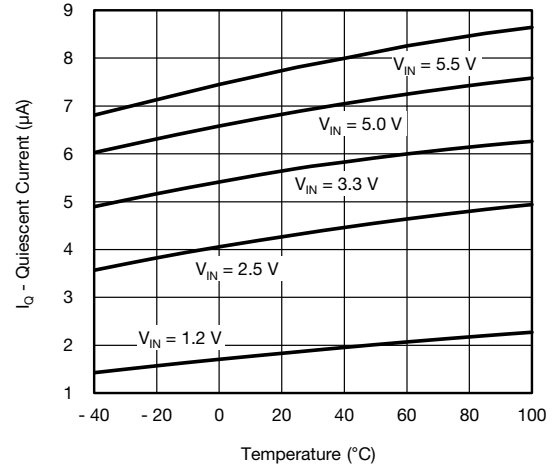


Fig. 7 - Quiescent Current vs. Temperature

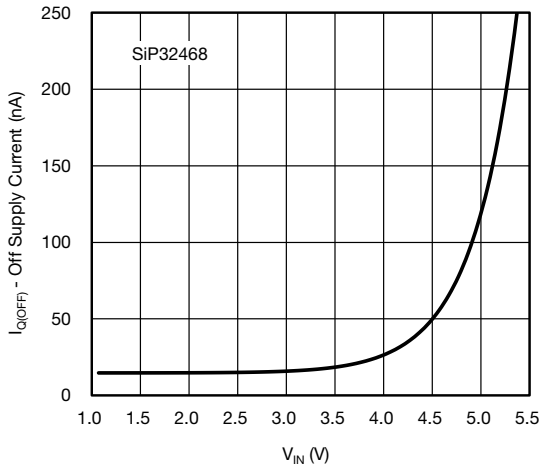


Fig. 5 - Off Supply Current vs. Input Voltage

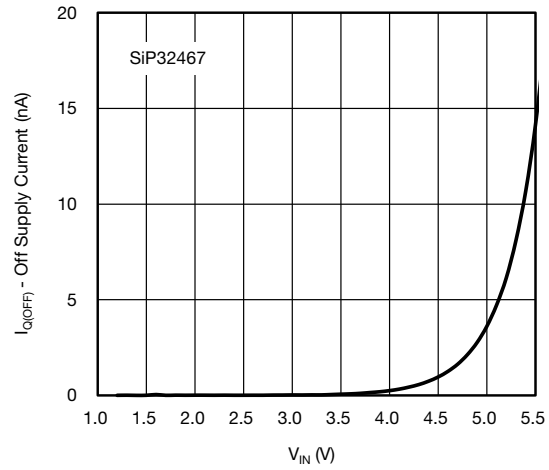


Fig. 8 - Off Supply Current vs. Input Voltage

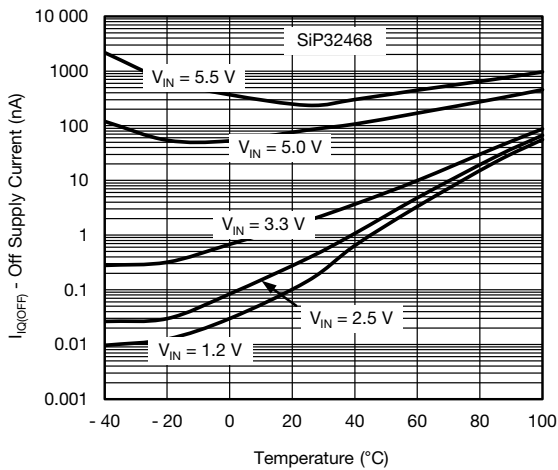


Fig. 6 - Off Supply Current vs. Temperature

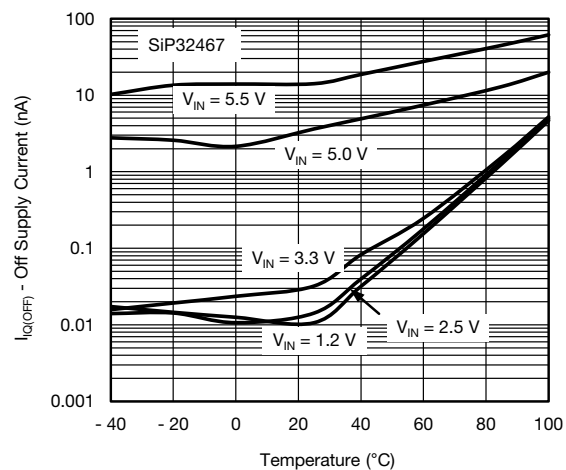


Fig. 9 - Off Supply Current vs. Temperature



TYPICAL CHARACTERISTICS (T<sub>J</sub> = 25 °C, unless otherwise noted)

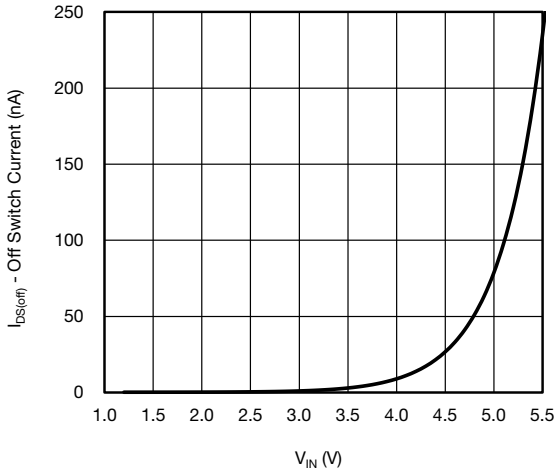


Fig. 10 - Off Switch Current vs. Input Voltage

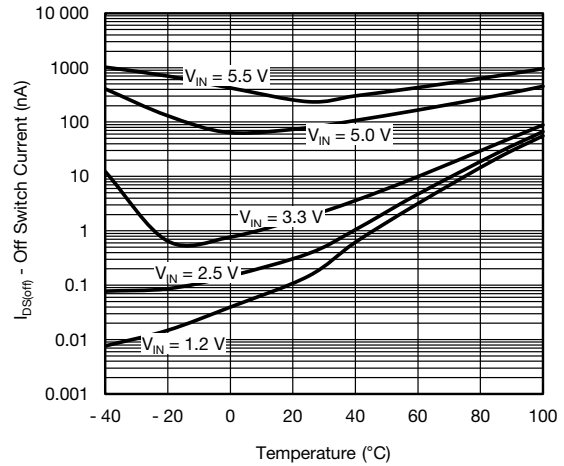


Fig. 13 - Off Switch Current vs. Temperature

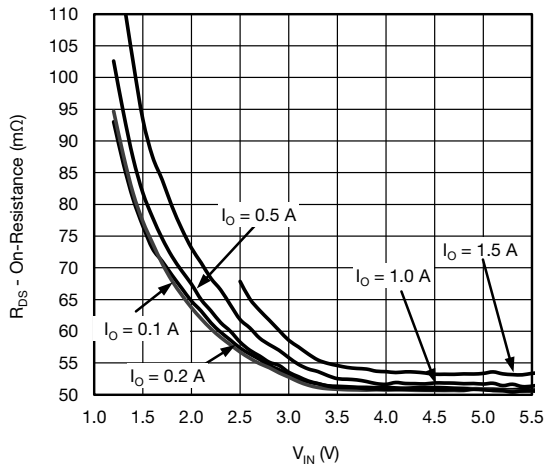


Fig. 11 - R<sub>DS(on)</sub> vs. Input Voltage

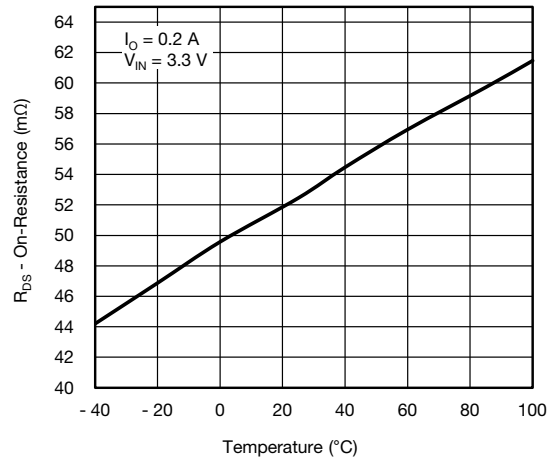


Fig. 14 - R<sub>DS(on)</sub> vs. Temperature

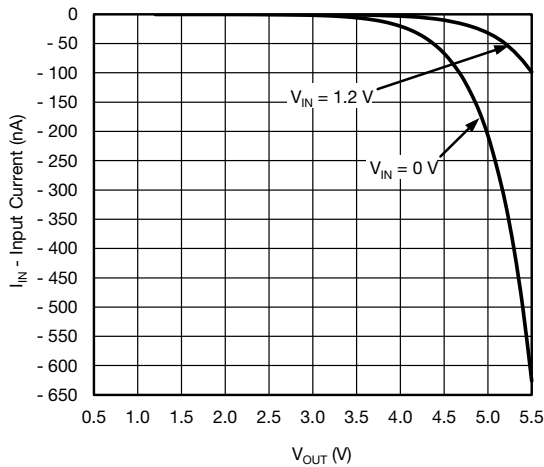


Fig. 12 - Reverse Blocking Current vs. Output Voltage

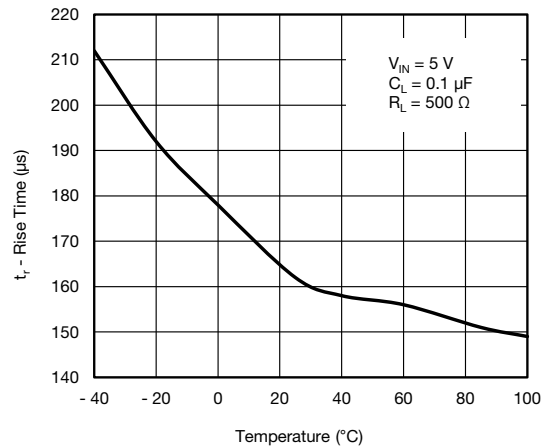


Fig. 15 - Rise Time vs. Temperature

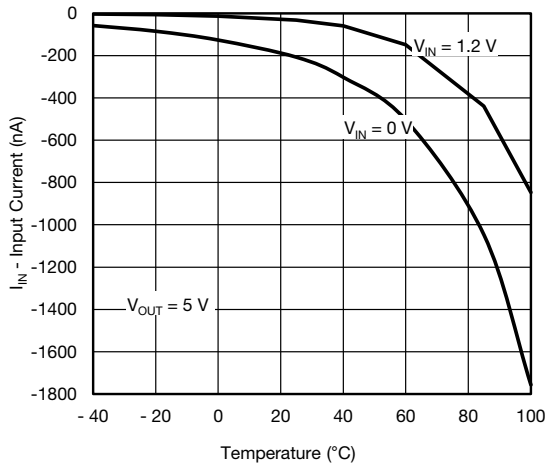
**TYPICAL CHARACTERISTICS** ( $T_J = 25\text{ }^\circ\text{C}$ , unless otherwise noted)


Fig. 16 - Reverse Blocking Current vs. Temperature

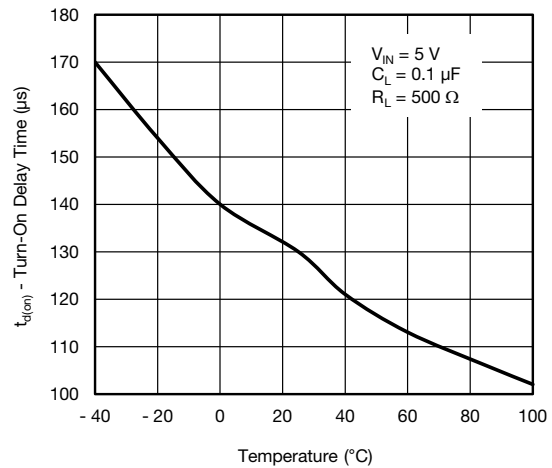


Fig. 19 - Turn-on Delay Time vs. Temperature

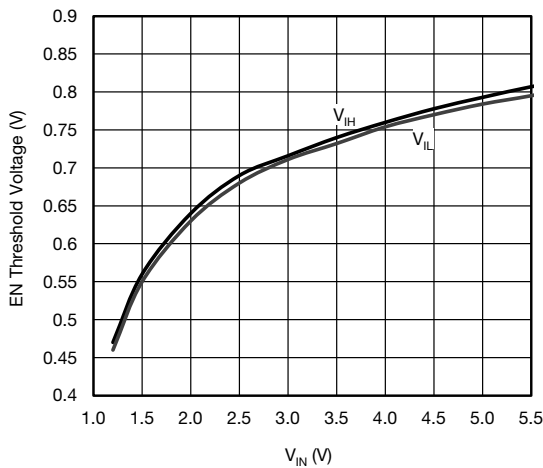


Fig. 17 - EN Threshold Voltage vs. Input Voltage

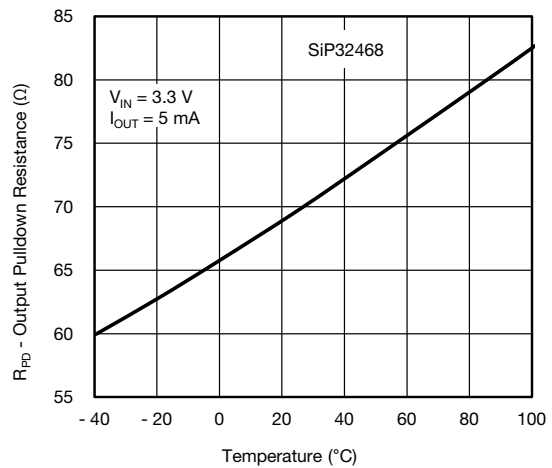


Fig. 20 - Output Pulldown Resistance vs. Temperature

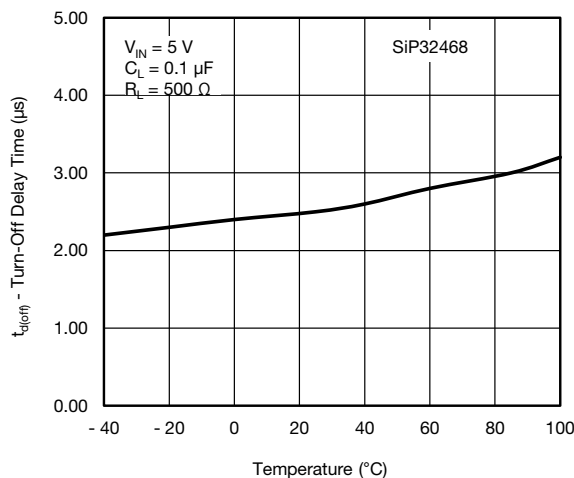


Fig. 18 - Turn-off Delay Time vs. Temperature

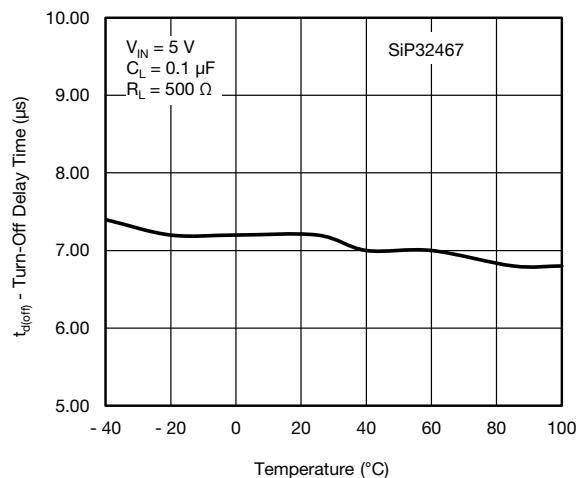


Fig. 21 - Turn-off Delay Time vs. Temperature

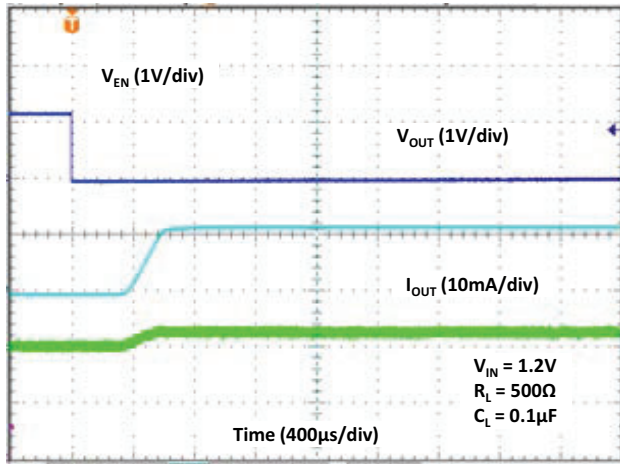
**TYPICAL WAVEFORMS**


Fig. 22 - Turn-on Time

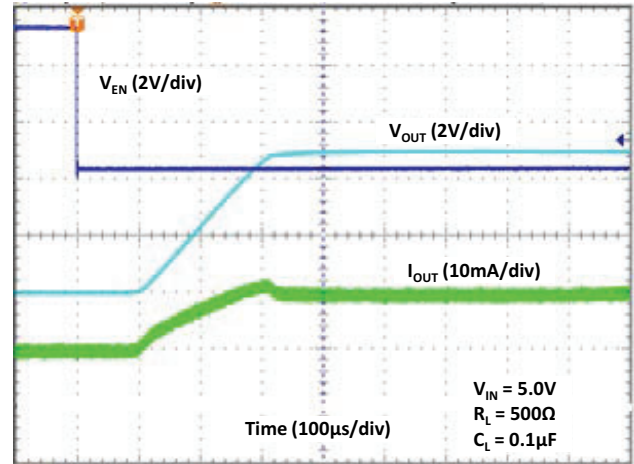


Fig. 25 - Turn-on Time

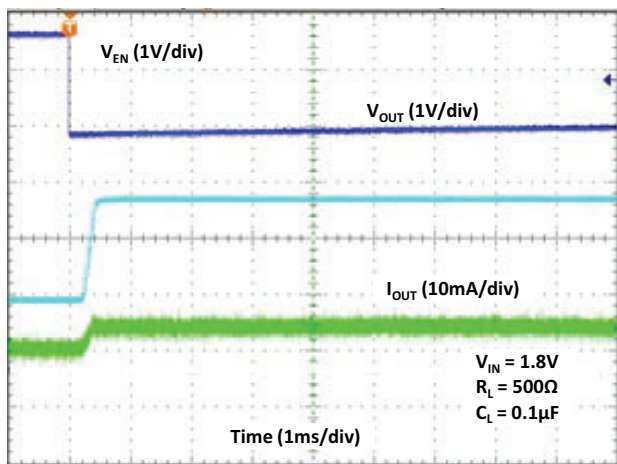


Fig. 23 - Turn-on Time

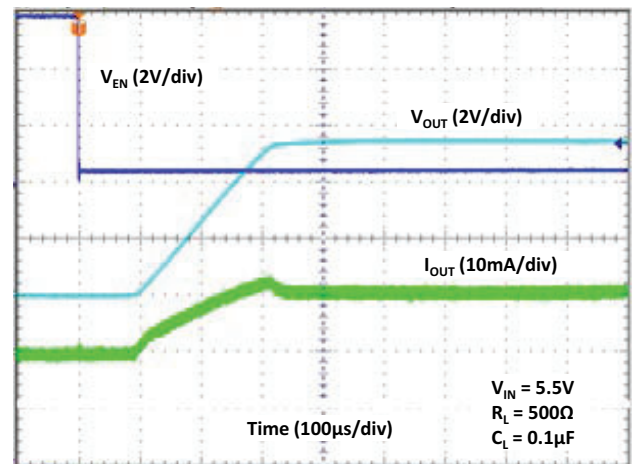


Fig. 26 - Turn-on Time

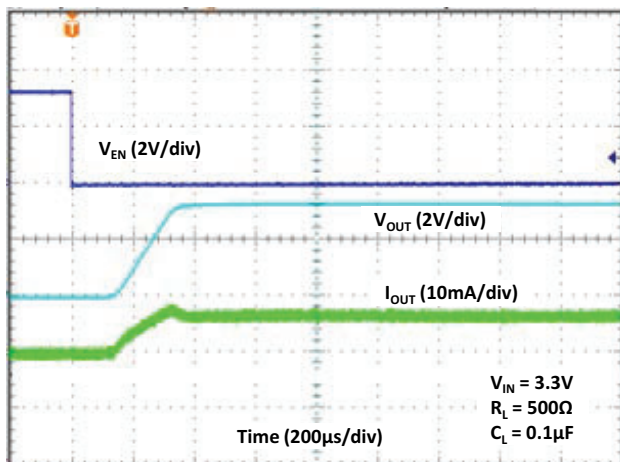


Fig. 24 - Turn-on Time

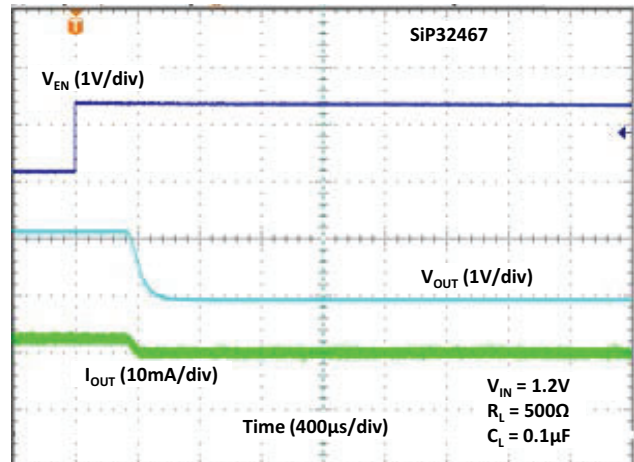


Fig. 27 - Turn-off Time



**TYPICAL WAVEFORMS**

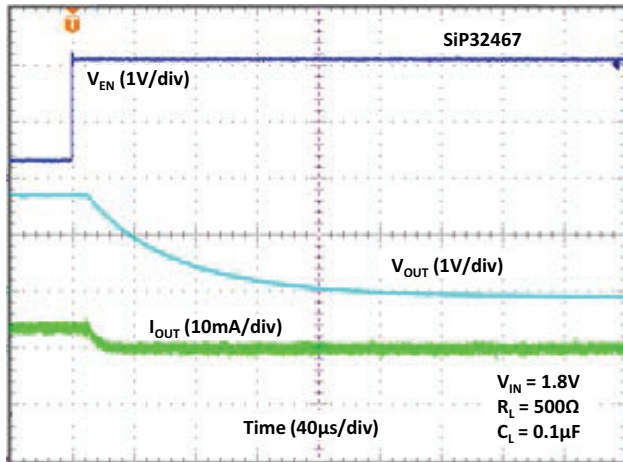


Fig. 28 - Turn-off Time

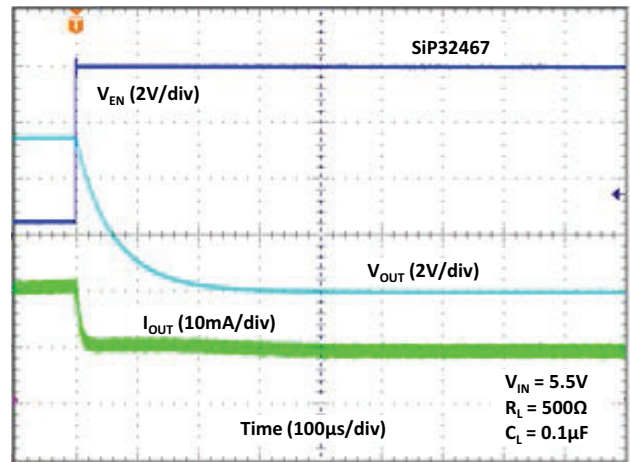


Fig. 31 - Turn-off Time

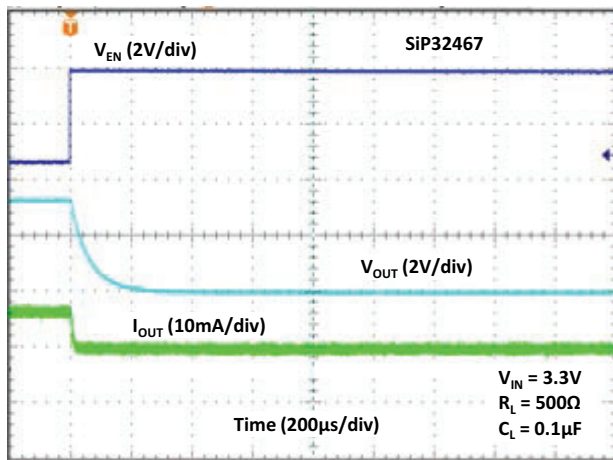


Fig. 29 - Turn-off Time

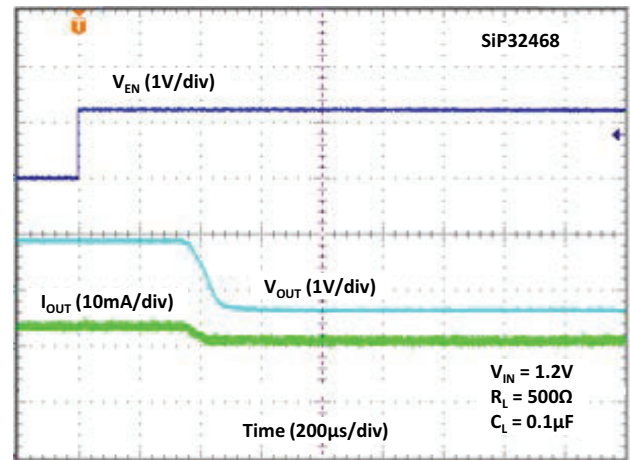


Fig. 32 - Turn-off Time

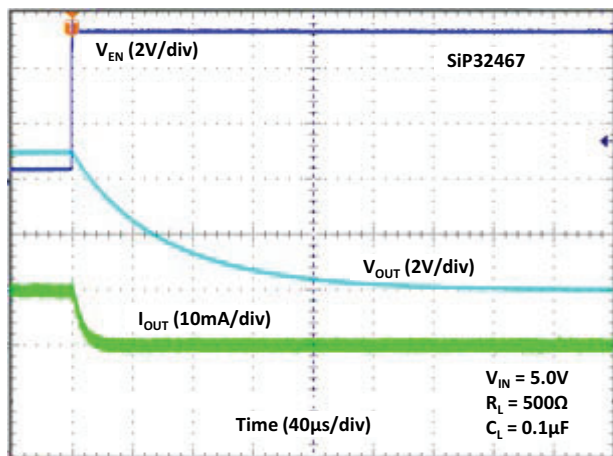


Fig. 30 - Turn-off Time

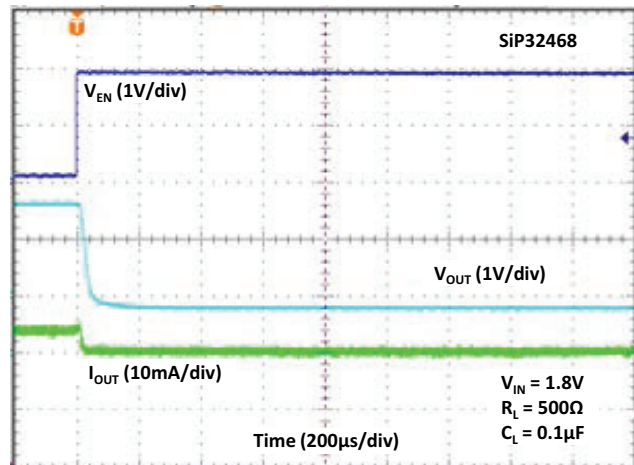


Fig. 33 - Turn-off Time

**TYPICAL WAVEFORMS**

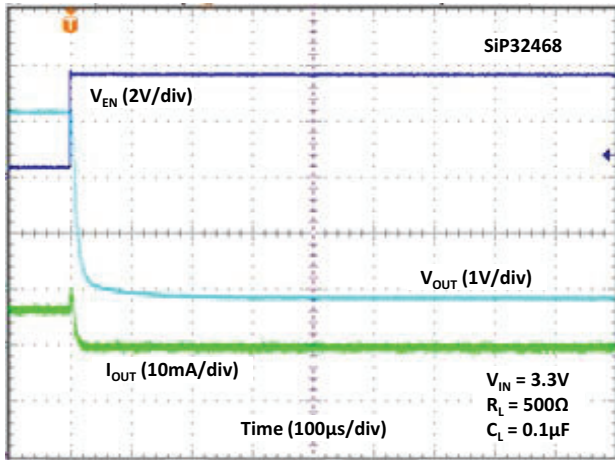


Fig. 34 - Turn-off Time

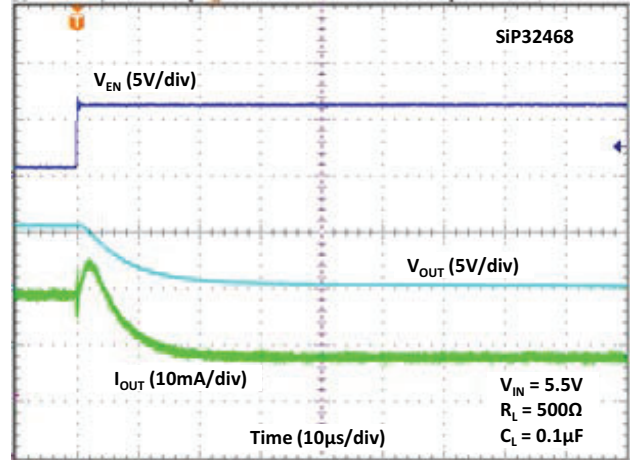


Fig. 36 - Turn-off Time

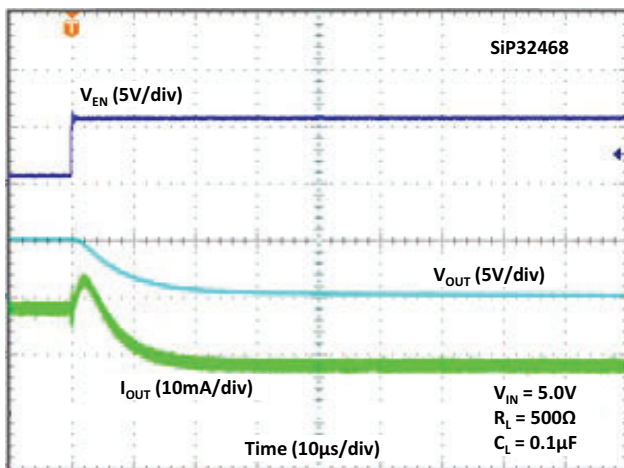


Fig. 35 - Turn-off Time



### DETAILED DESCRIPTION

SiP32467 and SiP32468 are high side, slew rate controlled, load switches. They incorporate a negative charge pump at the gate to keep the gate to source voltage high when turned on. This keeps the on resistance low at lower input voltages. SiP32467 and SiP32468 are designed with slow slew rate to minimize the inrush current during turn on. These devices have a reverse blocking circuit, when disabled, to prevent the current from going back to the input when the output voltage is higher than the input voltage. The SiP32467 can be used as a bi-directional switch and can be turned ON and OFF when power is at either IN or OUT. The SiP32468 has an output pull down resistor to discharge the output capacitance when the device is off.

### APPLICATION INFORMATION

#### Input Capacitor

While a bypass capacitor on the input is not required, a 4.7 μF or larger capacitor for C<sub>IN</sub> is recommended in almost all applications. The bypass capacitor should be placed as physically close as possible to the input pin to be effective in minimizing transients on the input. Ceramic capacitors are recommended over tantalum because of their ability to withstand input current surges from low impedance sources such as batteries in portable devices.

#### Output Capacitor

A 0.1 μF capacitor across V<sub>OUT</sub> and GND is recommended to insure proper slew operation. There is inrush current through the output MOSFET and the magnitude of the inrush current depends on the output capacitor, the bigger the C<sub>OUT</sub> the higher the inrush current. There are no ESR or capacitor type requirement.

#### Enable

The EN pin is compatible with CMOS logic voltage levels. It requires at least 1 V or above to fully shut down the device and 0.4 V or below to fully turn on the device. There is a 2.6 MΩ resistor connected between EN pin and IN pin.

#### Protection Against Reverse Voltage Condition

This device contains a reverse blocking circuit. When disabled (V<sub>EN</sub> greater than 1 V) this circuit keeps the output current from flowing back to the input when the output voltage is higher than the input voltage.

#### Thermal Considerations

Due to physical limitations of the layout and assembly of the device the maximum switch current is 1.2 A as stated in the Absolute Maximum Ratings table. However, another limiting

characteristic for the safe operating load current is the thermal power dissipation of the package.

The maximum power dissipation in any application is dependant on the maximum junction temperature, T<sub>J(max.)</sub> = 125 °C, the junction-to-ambient thermal resistance, θ<sub>J-A</sub> = 205 °C/W, and the ambient temperature, T<sub>A</sub>, which may be expressed as:

$$P \text{ (max.)} = \frac{T_J \text{ (max.)} - T_A}{\theta_{J-A}} = \frac{125 - T_A}{205}$$

It then follows that, assuming an ambient temperature of 70 °C, the maximum power dissipation will be limited to about 268 mW.

So long as the load current is below the 1.2 A limit, the maximum continuous switch current becomes a function two things: the package power dissipation and the R<sub>DS(ON)</sub> at the ambient temperature.

As an example let us calculate the worst case maximum load current at T<sub>A</sub> = 70 °C. The worst case R<sub>DS(ON)</sub> at 25 °C is 120 mΩ at V<sub>IN</sub> = 1.5 V. The R<sub>DS(ON)</sub> at 70 °C can be extrapolated from this data using the following formula:

$$R_{DS(ON)} \text{ (at } 70 \text{ }^\circ\text{C)} = R_{DS(ON)} \text{ (at } 25 \text{ }^\circ\text{C)} \times (1 + T_C \times \Delta T)$$

Where T<sub>C</sub> is 2800 ppm/°C. Continuing with the calculation we have

$$R_{DS(ON)} \text{ (at } 70 \text{ }^\circ\text{C)} = 120 \text{ m}\Omega \times (1 + 0.0028 \times (70 \text{ }^\circ\text{C} - 25 \text{ }^\circ\text{C})) = 135 \text{ m}\Omega$$

The maximum current limit is then determined by

$$I_{LOAD} \text{ (max.)} < \sqrt{\frac{P \text{ (max.)}}{R_{DS(ON)}}}$$

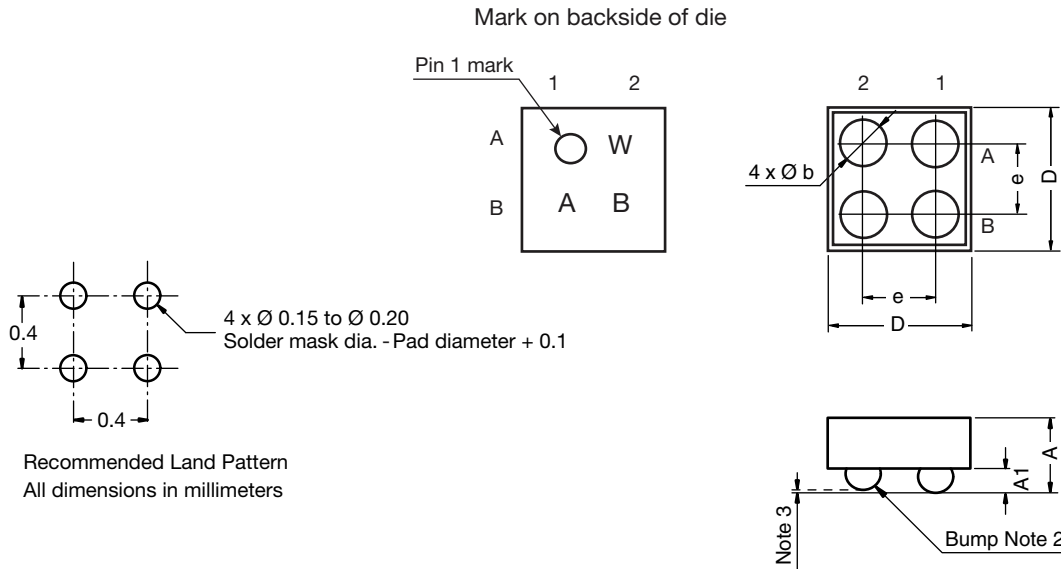
which in this case is 1.99 A. Under the stated input voltage condition, if the 1.99 A current limit is exceeded the internal die temperature will rise and eventually, possibly damage the device.

To avoid possible permanent damage to the device and keep a reasonable design margin, it is recommended to operate the device maximum up to 1.2 A only as listed in the Absolute Maximum Ratings table.

Vishay Siliconix maintains worldwide manufacturing capability. Products may be manufactured at one of several qualified locations. Reliability data for Silicon Technology and Package Reliability represent a composite of all qualified locations. For related documents such as package/tape drawings, part marking, and reliability data, see [www.vishay.com/ppg?67757](http://www.vishay.com/ppg?67757)

## WCSP4: 4 Bumps

(2 x 2, 0.4 mm pitch, 208 μm bump height, 0.8 mm x 0.8 mm die size)



DWG-No: 6004

### Notes

- (1) Laser mark on the backside surface of die
- (2) Bumps are SAC396
- (3) 0.05 max. coplanarity

DIM.	MILLIMETERS <sup>a</sup>			INCHES		
	MIN.	NOM.	MAX.	MIN.	NOM.	MAX.
A	0.515	0.530	0.545	0.0202	0.0208	0.0214
A1	0.208			0.0081		
b	0.250	0.260	0.270	0.0098	0.0102	0.0106
e	0.400			0.0157		
D	0.720	0.760	0.800	0.0182	0.0193	0.0203

### Note

- a. Use millimeters as the primary measurement.



## Disclaimer

ALL PRODUCT, PRODUCT SPECIFICATIONS AND DATA ARE SUBJECT TO CHANGE WITHOUT NOTICE TO IMPROVE RELIABILITY, FUNCTION OR DESIGN OR OTHERWISE.

Vishay Intertechnology, Inc., its affiliates, agents, and employees, and all persons acting on its or their behalf (collectively, "Vishay"), disclaim any and all liability for any errors, inaccuracies or incompleteness contained in any datasheet or in any other disclosure relating to any product.

Vishay makes no warranty, representation or guarantee regarding the suitability of the products for any particular purpose or the continuing production of any product. To the maximum extent permitted by applicable law, Vishay disclaims (i) any and all liability arising out of the application or use of any product, (ii) any and all liability, including without limitation special, consequential or incidental damages, and (iii) any and all implied warranties, including warranties of fitness for particular purpose, non-infringement and merchantability.

Statements regarding the suitability of products for certain types of applications are based on Vishay's knowledge of typical requirements that are often placed on Vishay products in generic applications. Such statements are not binding statements about the suitability of products for a particular application. It is the customer's responsibility to validate that a particular product with the properties described in the product specification is suitable for use in a particular application. Parameters provided in datasheets and/or specifications may vary in different applications and performance may vary over time. All operating parameters, including typical parameters, must be validated for each customer application by the customer's technical experts. Product specifications do not expand or otherwise modify Vishay's terms and conditions of purchase, including but not limited to the warranty expressed therein.

Except as expressly indicated in writing, Vishay products are not designed for use in medical, life-saving, or life-sustaining applications or for any other application in which the failure of the Vishay product could result in personal injury or death. Customers using or selling Vishay products not expressly indicated for use in such applications do so at their own risk. Please contact authorized Vishay personnel to obtain written terms and conditions regarding products designed for such applications.

No license, express or implied, by estoppel or otherwise, to any intellectual property rights is granted by this document or by any conduct of Vishay. Product names and markings noted herein may be trademarks of their respective owners.

## Material Category Policy

**Vishay Intertechnology, Inc. hereby certifies that all its products that are identified as RoHS-Compliant fulfill the definitions and restrictions defined under Directive 2011/65/EU of The European Parliament and of the Council of June 8, 2011 on the restriction of the use of certain hazardous substances in electrical and electronic equipment (EEE) - recast, unless otherwise specified as non-compliant.**

**Please note that some Vishay documentation may still make reference to RoHS Directive 2002/95/EC. We confirm that all the products identified as being compliant to Directive 2002/95/EC conform to Directive 2011/65/EU.**

**Vishay Intertechnology, Inc. hereby certifies that all its products that are identified as Halogen-Free follow Halogen-Free requirements as per JEDEC JS709A standards. Please note that some Vishay documentation may still make reference to the IEC 61249-2-21 definition. We confirm that all the products identified as being compliant to IEC 61249-2-21 conform to JEDEC JS709A standards.**



## Стандарт Электрон Связь

Мы молодая и активно развивающаяся компания в области поставок электронных компонентов. Мы поставляем электронные компоненты отечественного и импортного производства напрямую от производителей и с крупнейших складов мира.

Благодаря сотрудничеству с мировыми поставщиками мы осуществляем комплексные и плановые поставки широчайшего спектра электронных компонентов.

Собственная эффективная логистика и склад в обеспечивает надежную поставку продукции в точно указанные сроки по всей России.

Мы осуществляем техническую поддержку нашим клиентам и предпродажную проверку качества продукции. На все поставляемые продукты мы предоставляем гарантию .

Осуществляем поставки продукции под контролем ВП МО РФ на предприятия военно-промышленного комплекса России , а также работаем в рамках 275 ФЗ с открытием отдельных счетов в уполномоченном банке. Система менеджмента качества компании соответствует требованиям ГОСТ ISO 9001.

Минимальные сроки поставки, гибкие цены, неограниченный ассортимент и индивидуальный подход к клиентам являются основой для выстраивания долгосрочного и эффективного сотрудничества с предприятиями радиоэлектронной промышленности, предприятиями ВПК и научно-исследовательскими институтами России.

С нами вы становитесь еще успешнее!

### Наши контакты:

**Телефон:** +7 812 627 14 35

**Электронная почта:** [sales@st-electron.ru](mailto:sales@st-electron.ru)

**Адрес:** 198099, Санкт-Петербург,  
Промышленная ул, дом № 19, литера Н,  
помещение 100-Н Офис 331