



**Features**

- High Gain: 21dB
- High Linearity and Low Distortion
  - 41dBm OIP3 at 500MHz
  - -60dBc CSO
  - -87dBc CTB
- Single 8V Supply
- Noise Figure: 3dB at 500MHz
- SOT-89 Package

**Applications**

- Broadband 75Ω Gain Block
- CATV Distribution Amplifiers
- Pre-amplifier for CATV Multi-Dwelling Units

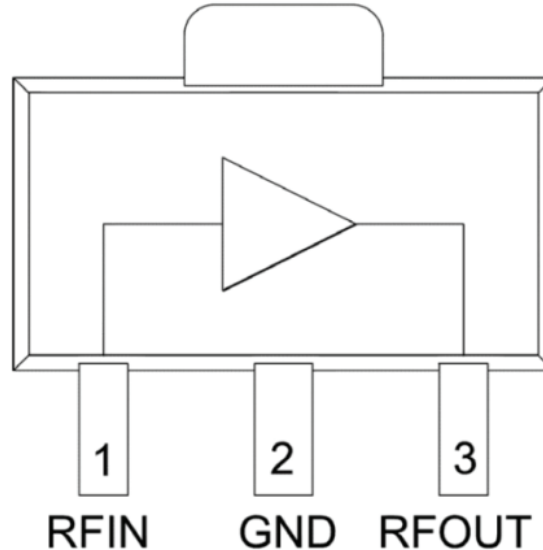

Functional Block Diagram

**Product Description**

RFMD's RFCA3306 is a high performance InGaP HBT MMIC amplifier designed to run from a single +8V supply, without the need for an external dropping resistor. The high gain, high linearity, and low distortion from 50MHz to 1000MHz make this part ideal for broadband cable applications. An integrated active bias circuit provides stable gain over temperature and process variations. It is offered in a small SOT-89 package and is RoHS compliant.

**Ordering Information**

RFCA3306SQ	Sample bag with 25 pieces
RFCA3306SR	7" Reel with 100 pieces
RFCA3306TR13	13" Reel with 2500 pieces
RFCA3306PCK-410	50MHz to 1000MHz PCBA with 5-piece sample bag

## Absolute Maximum Ratings

Parameter	Rating	Unit
Max Device Current ( $I_{CC}$ )	170	mA
Max Device Voltage ( $V_{CC}$ )	9	V
Max CW RF Input Power	15	dBm
Max Operating Junction Temp ( $T_J$ )	170	°C
Operating Temperature Range ( $T_L$ )	-40 to +85	°C
Storage Temperature	-40 to +150	°C
ESD Rating (HBM)	1000V	
Moisture Sensitivity Level	MSL2	



**Caution!** ESD sensitive device.

Exceeding any one or a combination of the Absolute Maximum Rating conditions may cause permanent damage to the device. Extended application of Absolute Maximum Rating conditions to the device may reduce device reliability. Specified typical performance or functional operation of the device under Absolute Maximum Rating conditions is not implied.

The information in this publication is believed to be accurate and reliable. However, no responsibility is assumed by RF Micro Devices, Inc. ("RFMD") for its use, nor for any infringement of patents, or other rights of third parties, resulting from its use. No license is granted by implication or otherwise under any patent or patent rights of RFMD. RFMD reserves the right to change component circuitry, recommended application circuitry and specifications at any time without prior notice.



RFMD Green: RoHS compliant per EU Directive 2002/95/EC, halogen free per IEC 61249-2-21, < 1000ppm each of antimony trioxide in polymeric materials and red phosphorus as a flame retardant, and <2% antimony in solder.

Notes:

1. The maximum ratings must all be met simultaneously.
2.  $P_{DISS} = P_{DC} + P_{RFIN} - P_{RFOUT}$
3.  $T_J = T_L + P_{DISS} * R_{TH}$

## Nominal Operating Parameters

Parameter	Specification			Unit	Condition
	Min.	Typ.	Max.		
<b>Overall (75Ω)</b>					50MHz to 1000MHz Application, $V_{CC} = 8.0V$ , $I_D = 140mA$ , $T_L = 25^\circ C$ , $Z_S = Z_L = 75\Omega$
Frequency Range	50		1000	MHz	
Small Signal Gain		22		dB	50MHz
	20	21		dB	500MHz
		18.5		dB	1000MHz
Gain Flatness		3.5		dB	
P1dB		24.5		dBm	50MHz to 1000MHz
Noise Figure		3		dBm	
Input Return Loss		13		dB	50MHz
		10.5		dB	1000MHz
Output Return Loss		14.5		dB	50MHz
		13.8		dB	1000MHz
Output IP3		43.8		dBm	50MHz, Tone Spacing = 6MHz, $P_{OUT}$ per Tone = +5dBm
	34	36.7		dBm	1000MHz, Tone Spacing = 6MHz, $P_{OUT}$ per Tone = +5dBm
Output IP2		59.5		dBm	50MHz, Tone Spacing = 30MHz, $P_{OUT}$ per Tone = +0dBm
		50.4		dBm	1000MHz, Tone Spacing = 30MHz, $P_{OUT}$ per Tone = +0dBm
CSO		-60		dBc	79 Channels, +29dBmV/ch output
CTB		-87		dBc	
XMOD		-85		dBc	
<b>Power Supply</b>					50MHz to 1000MHz Application, $T_L = 25^\circ C$ , $Z_S = Z_L = 75\Omega$
Device Operating Voltage ( $V_{CC}$ )	7.5	8	8.5	V	
Device Operating Current ( $I_{CC}$ )	125	140	155	mA	Quiescent, $V_{CC} = 8.0V$
Thermal Resistance ( $R_{TH}$ )		53		°C/W	Junction to backside of PCB under the IC, $V_{CC} = 8.0V$

**Typical Performance:  $V_{CC} = 8.0V$**

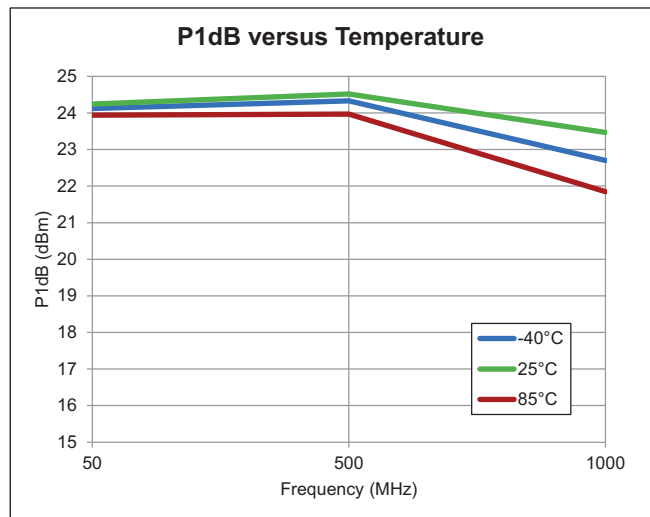
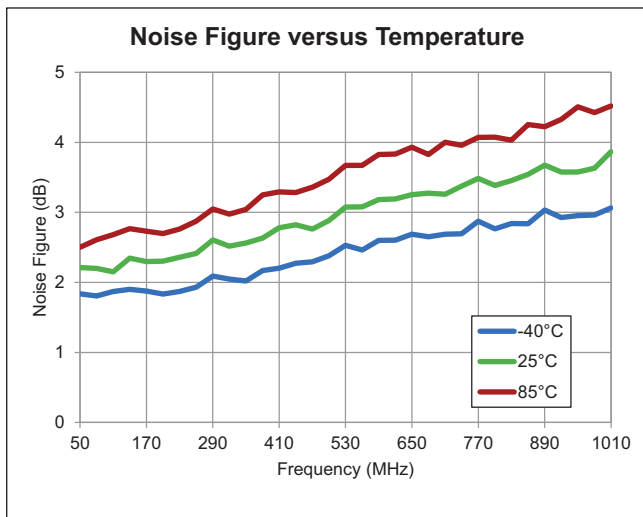
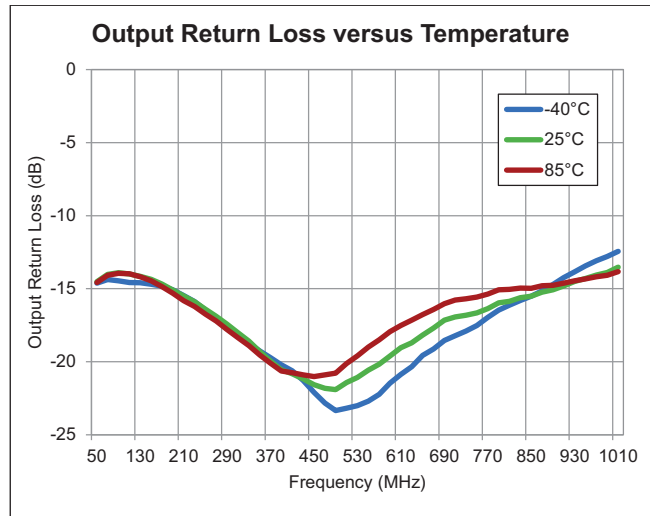
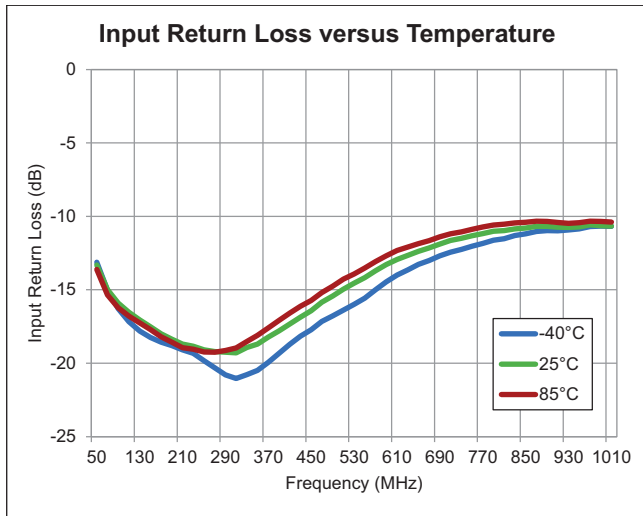
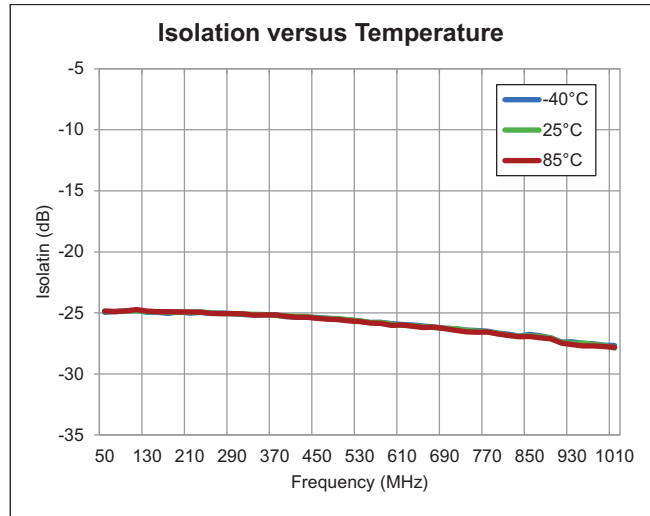
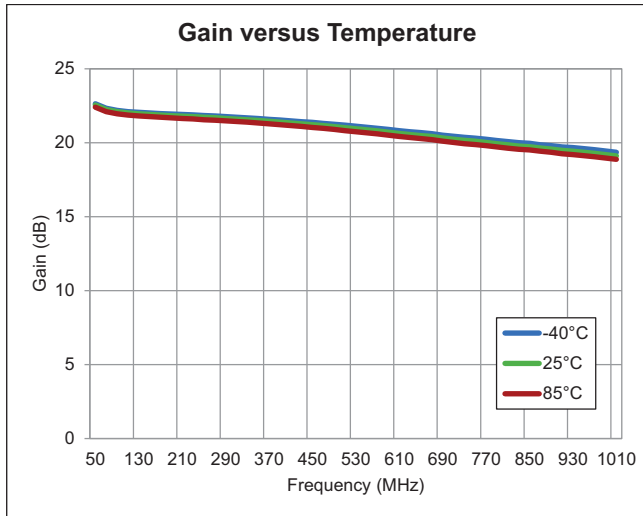

## Typical Performance: $V_{CC} = 8.0V$

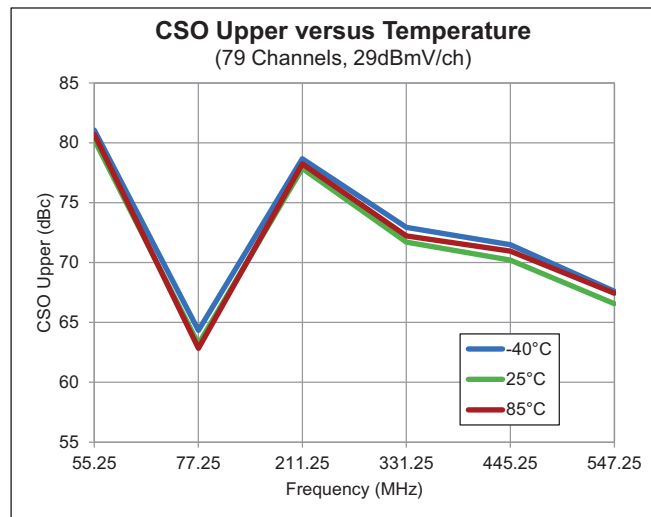
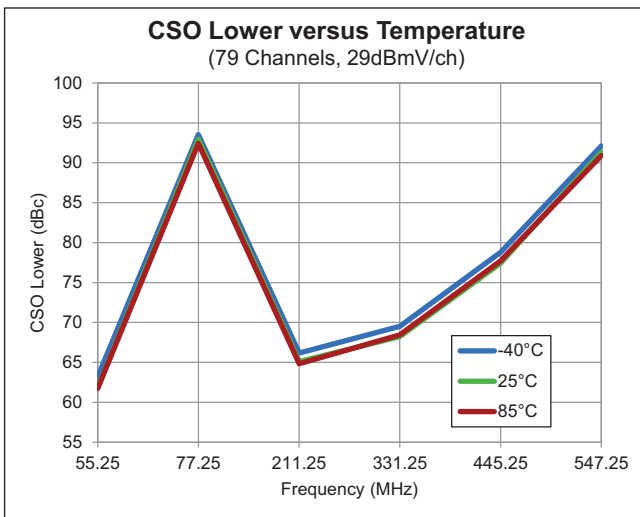
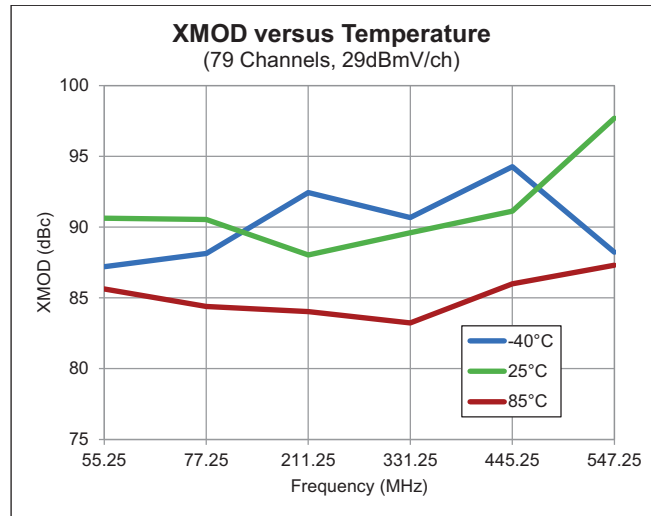
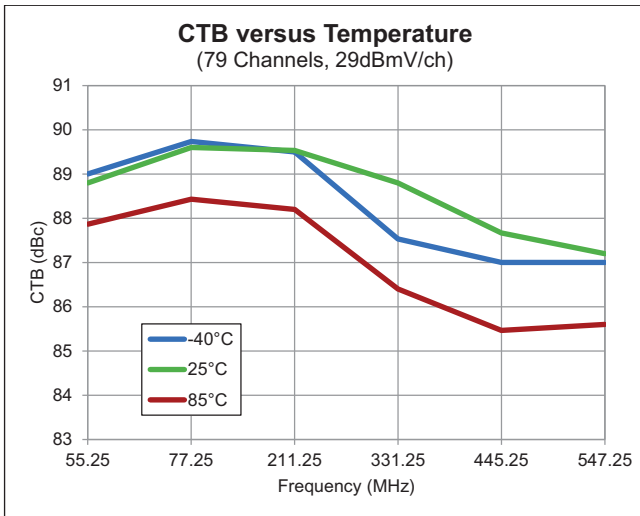
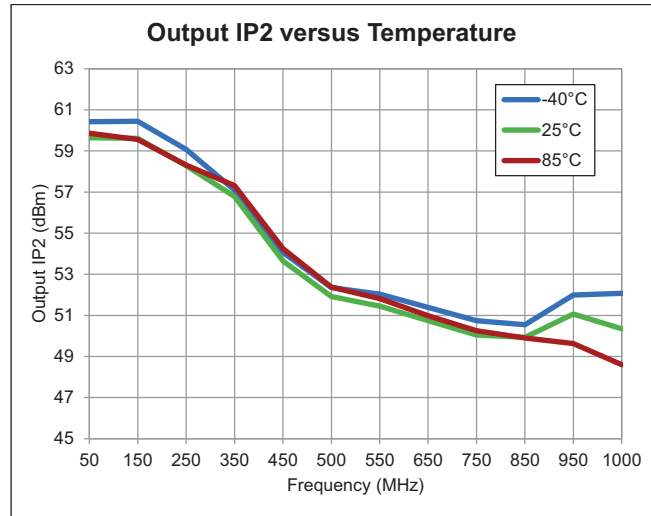
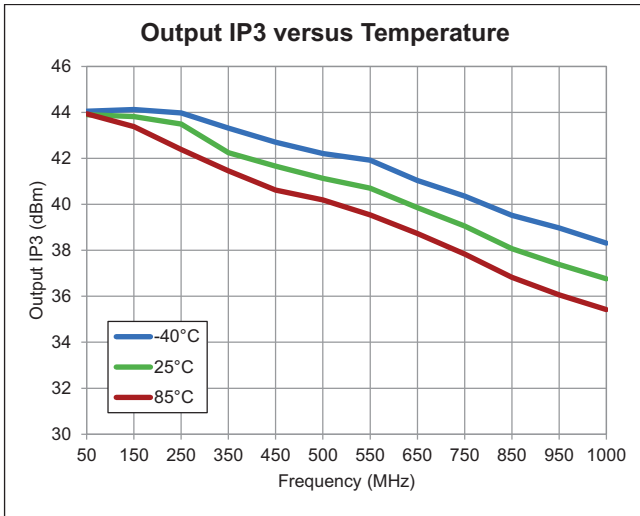

**Evaluation Board Schematic**

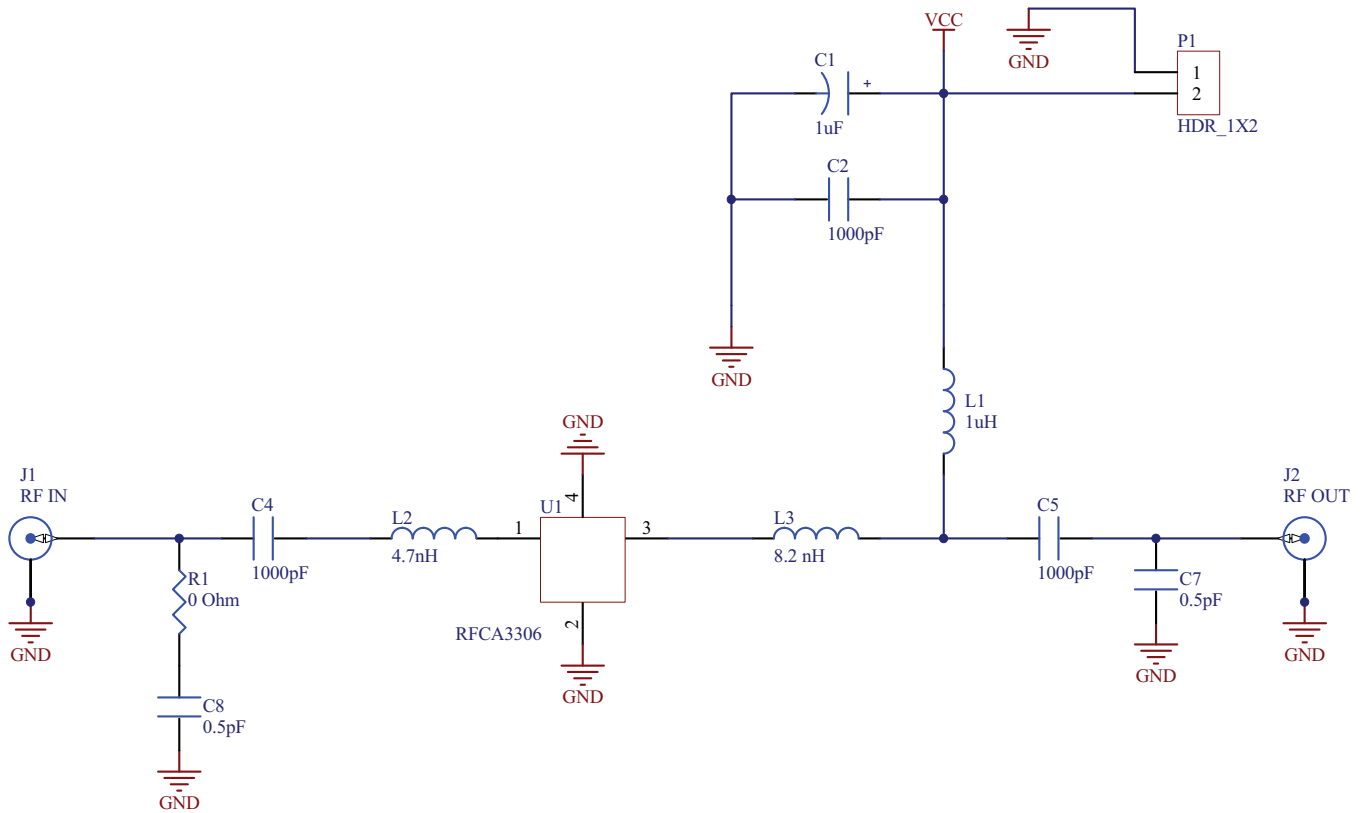

**Evaluation Board Bill of Materials (BOM)**

Description	Reference Designator	Manufacturer	Manufacturer's P/N
CA3310 Evaluation Board		Dynamic Details (DDI) Toronto	RFCA3310-410(A)
DUT	U1	RFMD	RFCA3306SB
CONN, HDR, ST, 2-PIN, 0.100"	P1	SAMTEC INC.	TSW-102-07-G-S
CONN, F FEM EDGE MOUNT, 75Ω, 0.068"	J1-J2	Millimeter Wave Technologies, LLC	MW-846-C-DD-75
IND, 1μH, 5%, W/W, 0805	L1	Coilcraft, Inc.	0805LS-102XJLC
IND, 4.7nH, +/-0.3nH, M/L, 0402	L2	Murata Electronics	LQG15HN4N7S02D
IND, 8.2nH, 5%, M/L, 0402	L3	Murata Electronics	LQG15HN8N2J02D
CAP, 1000pF, 10%, 50V, X7R, 0402	C2, C4-C5	Murata Electronics	GRM155R71H102KA01D
CAP, 1μF, 10%, 16V, X7R, 1206	C1	Murata Electronics	GRM31MR71E105KA01L
CAP, 0.5pF, +/-0.1pF, 50V, HI-Q, 0402	C7-C8	Murata Electronics	GJM1555C1HR50BB01D
RES, 0Ω, 0402	R1	Kamaya, Inc	RMC1/16SJPTH

## Evaluation Assembly Drawing

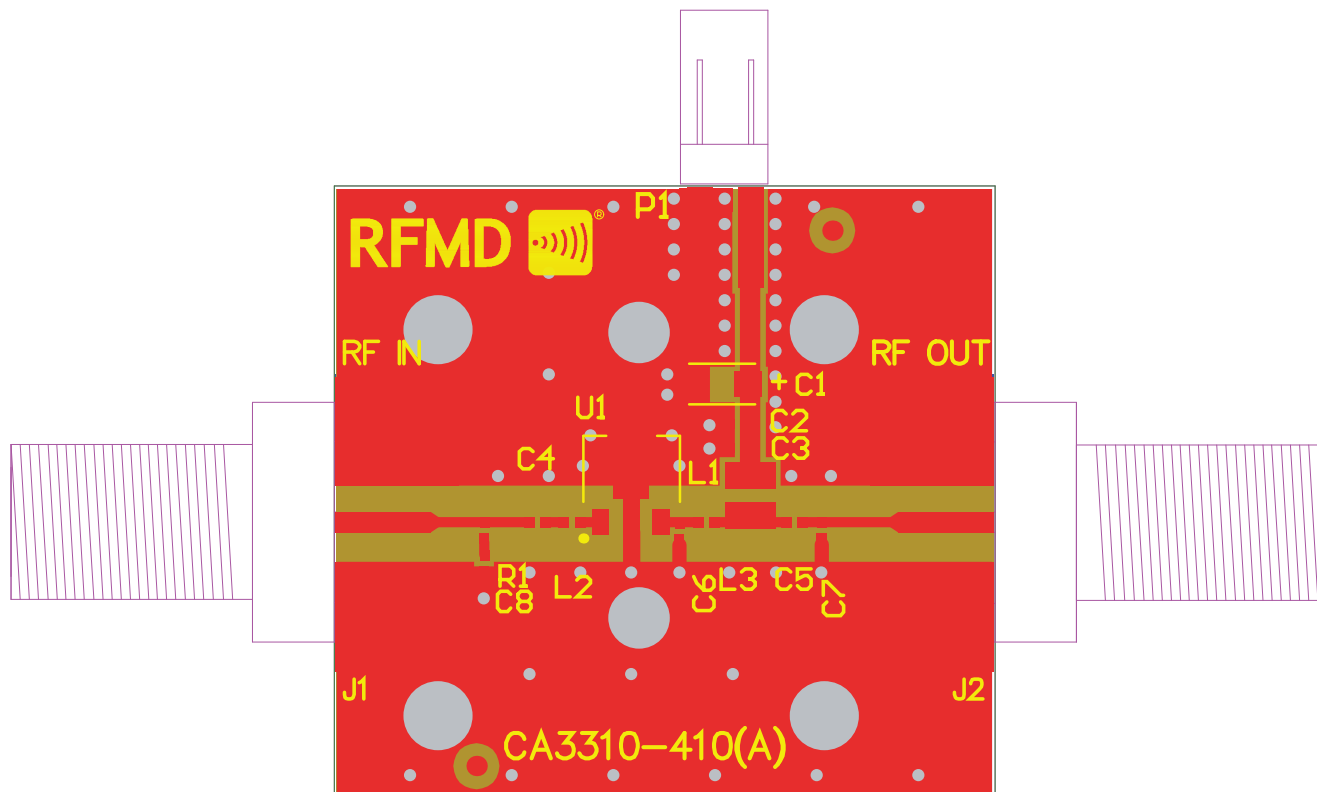

**Pin Names and Descriptions**

Pin	Name	Description
1	<b>RFIN</b>	RF Input. External DC-blocking capacitor is required.
2	<b>GND</b>	Connection to Ground. Use via holes for best performance to reduce lead inductance as close to ground leads as possible.
3	<b>RFOUT/VCC</b>	RF Output, Device Collector. DC voltage is present on this pin, therefore a DC blocking capacitor is necessary for proper operation.
4	<b>GND</b>	Connection to Ground. Use via holes for best performance to reduce lead inductance as close to ground leads as possible.

**Branding Diagram**

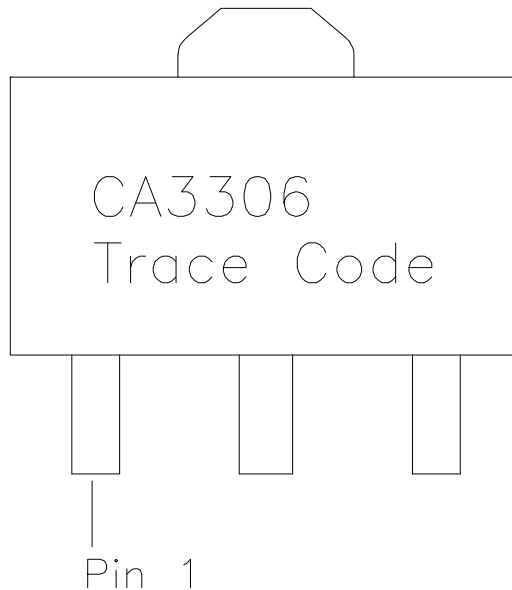

Refer to P.O. for  
Trace Code

## Package Drawing

Dimensions in millimeters

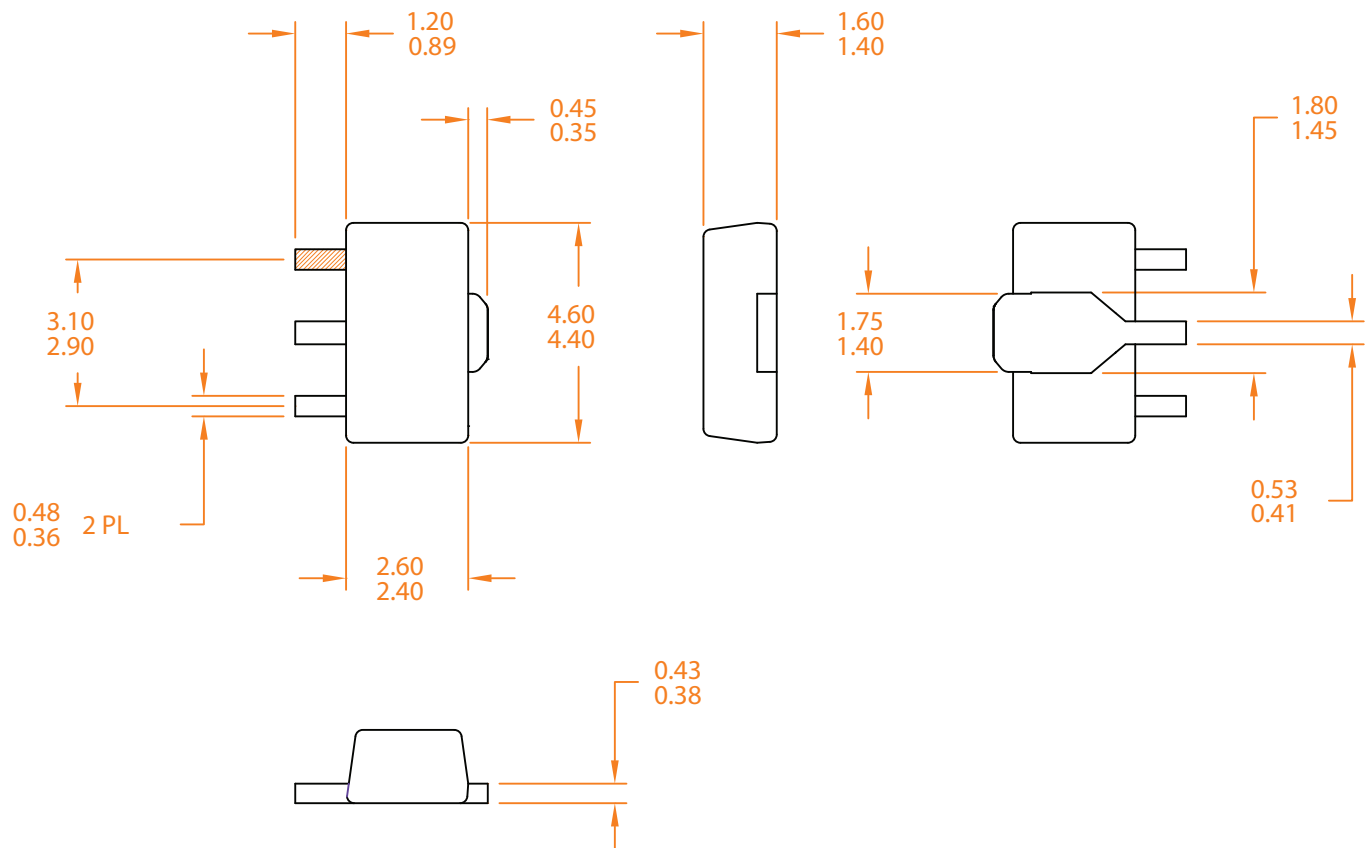





## Стандарт Электрон Связь

Мы молодая и активно развивающаяся компания в области поставок электронных компонентов. Мы поставляем электронные компоненты отечественного и импортного производства напрямую от производителей и с крупнейших складов мира.

Благодаря сотрудничеству с мировыми поставщиками мы осуществляем комплексные и плановые поставки широчайшего спектра электронных компонентов.

Собственная эффективная логистика и склад в обеспечивает надежную поставку продукции в точно указанные сроки по всей России.

Мы осуществляем техническую поддержку нашим клиентам и предпродажную проверку качества продукции. На все поставляемые продукты мы предоставляем гарантию .

Осуществляем поставки продукции под контролем ВП МО РФ на предприятия военно-промышленного комплекса России , а также работаем в рамках 275 ФЗ с открытием отдельных счетов в уполномоченном банке. Система менеджмента качества компании соответствует требованиям ГОСТ ISO 9001.

Минимальные сроки поставки, гибкие цены, неограниченный ассортимент и индивидуальный подход к клиентам являются основой для выстраивания долгосрочного и эффективного сотрудничества с предприятиями радиоэлектронной промышленности, предприятиями ВПК и научно-исследовательскими институтами России.

С нами вы становитесь еще успешнее!

### Наши контакты:

**Телефон:** +7 812 627 14 35

**Электронная почта:** [sales@st-electron.ru](mailto:sales@st-electron.ru)

**Адрес:** 198099, Санкт-Петербург,  
Промышленная ул, дом № 19, литера Н,  
помещение 100-Н Офис 331