

High Efficiency LED, \varnothing 3 mm Tinted Undiffused Package

Description

The TLH.42.. series was developed for standard applications like general indicating and lighting purposes.

It is housed in a 3 mm tinted clear plastic package. The wide viewing angle of these devices provides a high on-off contrast.

Several selection types with different luminous intensities are offered. All LEDs are categorized in luminous intensity groups. The green and yellow LEDs are categorized additionally in wavelength groups.

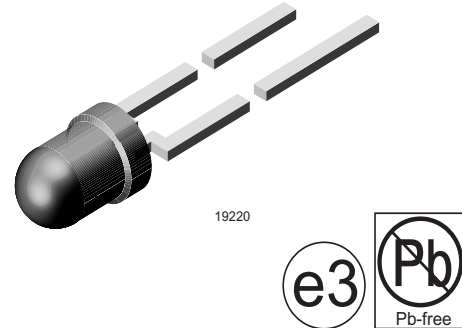

That allows users to assemble LEDs with uniform appearance.

Features

- Choice of five bright colors
- Standard T-1 package
- Small mechanical tolerances
- Suitable for DC and high peak current
- Wide viewing angle
- Luminous intensity categorized
- Yellow and green color categorized
- Lead-free device

Applications

- Status lights
- OFF / ON indicator
- Background illumination
- Readout lights
- Maintenance lights
- Legend light

Parts Table

Part	Color, Luminous Intensity	Angle of Half Intensity ($\pm\phi$)	Technology
TLHR4200	Red, $I_V > 4$ mcd	22 °	GaAsP on GaP
TLHR4201	Red, $I_V > 6.3$ mcd	22 °	GaAsP on GaP
TLHR4205	Red, $I_V > 10$ mcd	22 °	GaAsP on GaP
TLHO4200	Soft orange, $I_V > 4$ mcd	22 °	GaAsP on GaP
TLHO4201	Soft orange, $I_V > 10$ mcd	22 °	GaAsP on GaP
TLHY4200	Yellow, $I_V > 4$ mcd	22 °	GaAsP on GaP
TLHY4201	Yellow, $I_V > 6.3$ mcd	22 °	GaAsP on GaP
TLHY4205	Yellow, $I_V > 10$ mcd	22 °	GaAsP on GaP
TLHG4200	Green, $I_V > 6.3$ mcd	22 °	GaP on GaP
TLHG4201	Green, $I_V > 10$ mcd	22 °	GaP on GaP
TLHG4205	Green, $I_V > 16$ mcd	22 °	GaP on GaP
TLHP4200	Pure green, $I_V > 2.5$ mcd	22 °	GaP on GaP
TLHP4201	Pure green, $I_V > 6.3$ mcd	22 °	GaP on GaP

Absolute Maximum Ratings

$T_{amb} = 25\text{ }^{\circ}\text{C}$, unless otherwise specified

TLHR42.., TLHO42.., TLHY42.., TLHG42.., TLHP42..

Parameter	Test condition	Symbol	Value	Unit
Reverse voltage		V_R	6	V
DC Forward current		I_F	30	mA
Surge forward current	$t_p \leq 10\text{ }\mu\text{s}$	I_{FSM}	1	A
Power dissipation	$T_{amb} \leq 60\text{ }^{\circ}\text{C}$	P_V	100	mW
Junction temperature		T_j	100	$^{\circ}\text{C}$
Operating temperature range		T_{amb}	- 40 to + 100	$^{\circ}\text{C}$
Storage temperature range		T_{stg}	- 55 to + 100	$^{\circ}\text{C}$
Soldering temperature	$t \leq 5\text{ s}$, 2 mm from body	T_{sd}	260	$^{\circ}\text{C}$
Thermal resistance junction/ ambient		R_{thJA}	400	K/W

Optical and Electrical Characteristics

$T_{amb} = 25\text{ }^{\circ}\text{C}$, unless otherwise specified

Red

TLHR42..

Parameter	Test condition	Part	Symbol	Min	Typ.	Max	Unit
Luminous intensity ¹⁾	$I_F = 10\text{ mA}$	TLHR4200	I_V	4	8		mcd
		TLHR4201	I_V	6.3	10		mcd
		TLHR4205	I_V	10	15		mcd
Dominant wavelength	$I_F = 10\text{ mA}$		λ_d	612		625	nm
Peak wavelength	$I_F = 10\text{ mA}$		λ_p		635		nm
Angle of half intensity	$I_F = 10\text{ mA}$		φ		± 22		deg
Forward voltage	$I_F = 20\text{ mA}$		V_F		2	3	V
Reverse voltage	$I_R = 10\text{ }\mu\text{A}$		V_R	6	15		V
Junction capacitance	$V_R = 0$, $f = 1\text{ MHz}$		C_j		50		pF

¹⁾ in one Packing Unit $I_{Vmin}/I_{Vmax} \leq 0.5$

Soft Orange

TLHO42..

Parameter	Test condition	Part	Symbol	Min	Typ.	Max	Unit
Luminous intensity ¹⁾	$I_F = 10\text{ mA}$	TLHO4200	I_V	4	10		mcd
		TLHO4201	I_V	10	18		mcd
Dominant wavelength	$I_F = 10\text{ mA}$		λ_d	598		611	nm
Peak wavelength	$I_F = 10\text{ mA}$		λ_p		605		nm
Angle of half intensity	$I_F = 10\text{ mA}$		φ		± 22		deg
Forward voltage	$I_F = 20\text{ mA}$		V_F		2.4	3	V
Reverse current	$V_R = 6\text{ V}$		I_R			10	μA
Junction capacitance	$V_R = 0$, $f = 1\text{ MHz}$		C_j		50		pF

¹⁾ in one Packing Unit $I_{Vmin}/I_{Vmax} \leq 0.5$



Yellow

TLHY42..

Parameter	Test condition	Part	Symbol	Min	Typ.	Max	Unit
Luminous intensity ¹⁾	$I_F = 10 \text{ mA}$	TLHY4200	I_V	4	10		mcd
		TLHY4201	I_V	6.3	15		mcd
		TLHY4205	I_V	10	20		mcd
Dominant wavelength	$I_F = 10 \text{ mA}$		λ_d	581		594	nm
Peak wavelength	$I_F = 10 \text{ mA}$		λ_p		585		nm
Angle of half intensity	$I_F = 10 \text{ mA}$		ϕ		± 22		deg
Forward voltage	$I_F = 20 \text{ mA}$		V_F		2.4	3	V
Reverse voltage	$I_R = 10 \text{ }\mu\text{A}$		V_R	6	15		V
Junction capacitance	$V_R = 0, f = 1 \text{ MHz}$		C_j		50		pF

¹⁾ in one Packing Unit $I_{Vmin}/I_{Vmax} \leq 0.5$

Green

TLHG42..

Parameter	Test condition	Part	Symbol	Min	Typ.	Max	Unit
Luminous intensity ¹⁾	$I_F = 10 \text{ mA}$	TLHG4200	I_V	6.3	10		mcd
		TLHG4201	I_V	10	15		mcd
		TLHG4205	I_V	16	20		mcd
Dominant wavelength	$I_F = 10 \text{ mA}$		λ_d	562		575	nm
Peak wavelength	$I_F = 10 \text{ mA}$		λ_p		565		nm
Angle of half intensity	$I_F = 10 \text{ mA}$		ϕ		± 22		deg
Forward voltage	$I_F = 20 \text{ mA}$		V_F		2.4	3	V
Reverse voltage	$I_R = 10 \text{ }\mu\text{A}$		V_R	6	15		V
Junction capacitance	$V_R = 0, f = 1 \text{ MHz}$		C_j		50		pF

¹⁾ in one Packing Unit $I_{Vmin}/I_{Vmax} \leq 0.5$

Pure green

TLHP42..

Parameter	Test condition	Part	Symbol	Min	Typ.	Max	Unit
Luminous intensity ¹⁾	$I_F = 10 \text{ mA}$	TLHP4200	I_V	2.5	7		mcd
		TLHP4201	I_V	6.3		20	mcd
Dominant wavelength	$I_F = 10 \text{ mA}$		λ_d	555		565	nm
Peak wavelength	$I_F = 10 \text{ mA}$		λ_p		555		nm
Angle of half intensity	$I_F = 10 \text{ mA}$		ϕ		± 22		deg
Forward voltage	$I_F = 20 \text{ mA}$		V_F		2.4	3	V
Reverse voltage	$I_R = 10 \text{ }\mu\text{A}$		V_R	6	15		V
Junction capacitance	$V_R = 0, f = 1 \text{ MHz}$		C_j		50		pF

¹⁾ in one Packing Unit $I_{Vmin}/I_{Vmax} \leq 0.5$

Typical Characteristics ($T_{amb} = 25\text{ }^{\circ}\text{C}$ unless otherwise specified)



Figure 1. Power Dissipation vs. Ambient Temperature



Figure 4. Rel. Luminous Intensity vs. Angular Displacement



Figure 2. Forward Current vs. Ambient Temperature for InGaN



Figure 5. Forward Current vs. Forward Voltage

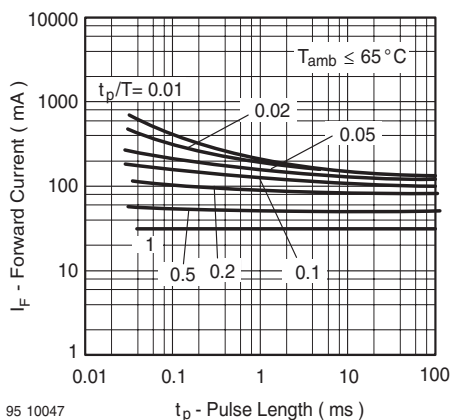

Figure 3. Forward Current vs. Pulse Length

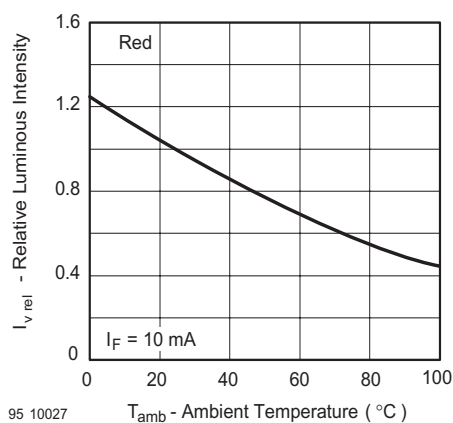

Figure 6. Rel. Luminous Intensity vs. Ambient Temperature



Figure 7. Rel. Lumin. Intensity vs. Forw. Current/Duty Cycle



Figure 10. Forward Current vs. Forward Voltage



Figure 8. Relative Luminous Intensity vs. Forward Current

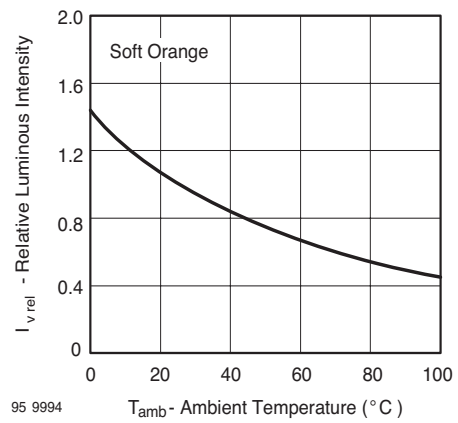

Figure 11. Rel. Luminous Intensity vs. Ambient Temperature



Figure 9. Relative Intensity vs. Wavelength

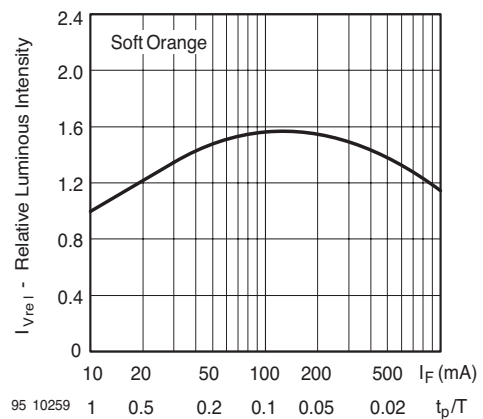

Figure 12. Rel. Lumin. Intensity vs. Forw. Current/Duty Cycle

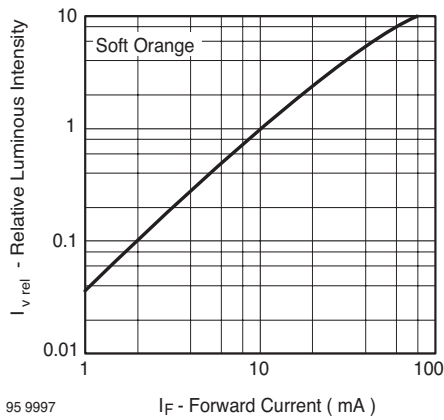

Figure 13. Relative Luminous Intensity vs. Forward Current

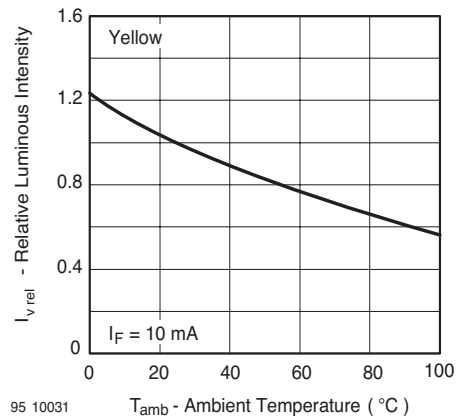

Figure 16. Rel. Luminous Intensity vs. Ambient Temperature



Figure 14. Relative Intensity vs. Wavelength

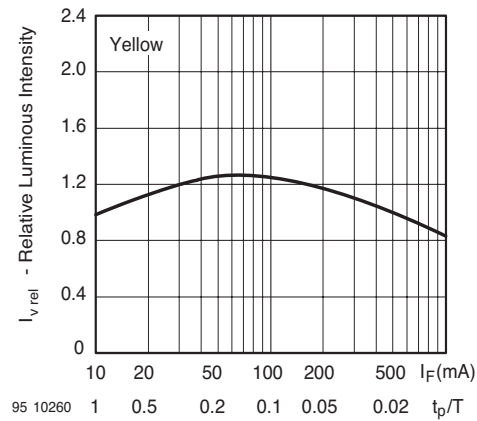

Figure 17. Rel. Lumin. Intensity vs. Forw. Current/Duty Cycle



Figure 15. Forward Current vs. Forward Voltage

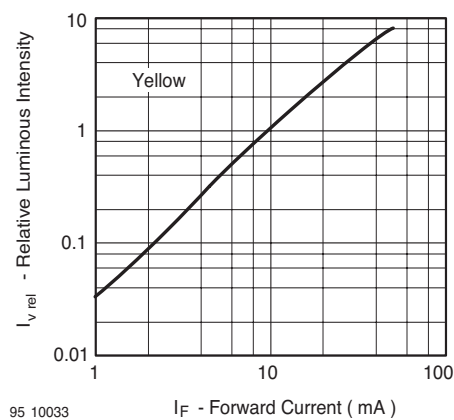

Figure 18. Relative Luminous Intensity vs. Forward Current



Figure 19. Relative Intensity vs. Wavelength



Figure 22. Specific Luminous Intensity vs. Forward Current



Figure 20. Forward Current vs. Forward Voltage



Figure 23. Relative Luminous Intensity vs. Forward Current



Figure 21. Rel. Luminous Intensity vs. Ambient Temperature



Figure 24. Relative Intensity vs. Wavelength

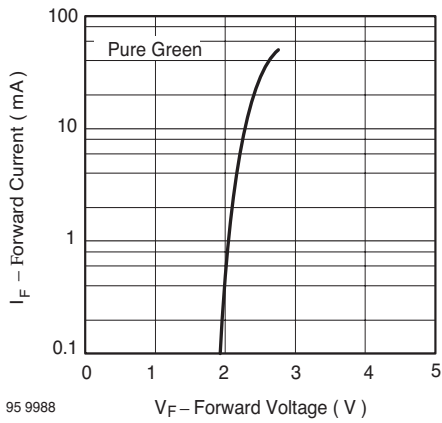

Figure 25. Forward Current vs. Forward Voltage

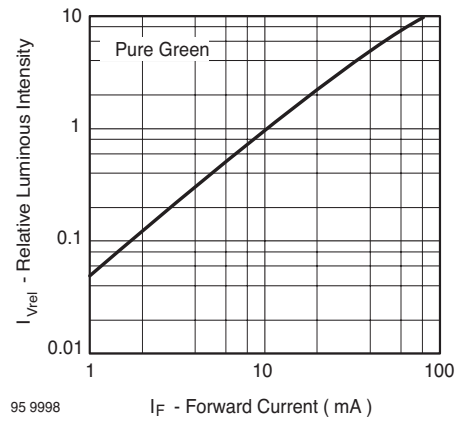

Figure 28. Relative Luminous Intensity vs. Forward Current



Figure 26. Rel. Luminous Intensity vs. Ambient Temperature



Figure 29. Relative Intensity vs. Wavelength

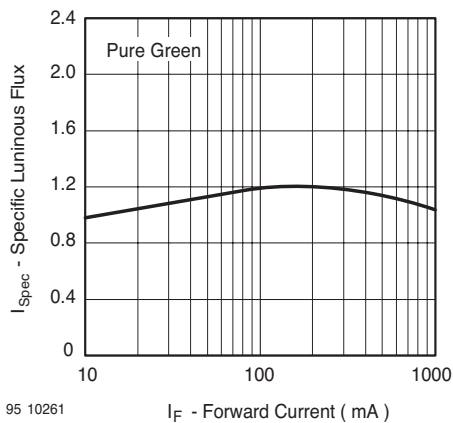

Figure 27. Specific Luminous Intensity vs. Forward Current



Package Dimensions in mm



Ozone Depleting Substances Policy Statement

It is the policy of **Vishay Semiconductor GmbH** to

1. Meet all present and future national and international statutory requirements.
2. Regularly and continuously improve the performance of our products, processes, distribution and operating systems with respect to their impact on the health and safety of our employees and the public, as well as their impact on the environment.

It is particular concern to control or eliminate releases of those substances into the atmosphere which are known as ozone depleting substances (ODSs).

The Montreal Protocol (1987) and its London Amendments (1990) intend to severely restrict the use of ODSs and forbid their use within the next ten years. Various national and international initiatives are pressing for an earlier ban on these substances.

Vishay Semiconductor GmbH has been able to use its policy of continuous improvements to eliminate the use of ODSs listed in the following documents.

1. Annex A, B and list of transitional substances of the Montreal Protocol and the London Amendments respectively
2. Class I and II ozone depleting substances in the Clean Air Act Amendments of 1990 by the Environmental Protection Agency (EPA) in the USA
3. Council Decision 88/540/EEC and 91/690/EEC Annex A, B and C (transitional substances) respectively.

Vishay Semiconductor GmbH can certify that our semiconductors are not manufactured with ozone depleting substances and do not contain such substances.

**We reserve the right to make changes to improve technical design
and may do so without further notice.**

Parameters can vary in different applications. All operating parameters must be validated for each customer application by the customer. Should the buyer use Vishay Semiconductors products for any unintended or unauthorized application, the buyer shall indemnify Vishay Semiconductors against all claims, costs, damages, and expenses, arising out of, directly or indirectly, any claim of personal damage, injury or death associated with such unintended or unauthorized use.

Vishay Semiconductor GmbH, P.O.B. 3535, D-74025 Heilbronn, Germany
Telephone: 49 (0)7131 67 2831, Fax number: 49 (0)7131 67 2423



Стандарт Электрон Связь

Мы молодая и активно развивающаяся компания в области поставок электронных компонентов. Мы поставляем электронные компоненты отечественного и импортного производства напрямую от производителей и с крупнейших складов мира.

Благодаря сотрудничеству с мировыми поставщиками мы осуществляем комплексные и плановые поставки широчайшего спектра электронных компонентов.

Собственная эффективная логистика и склад в обеспечивает надежную поставку продукции в точно указанные сроки по всей России.

Мы осуществляем техническую поддержку нашим клиентам и предпродажную проверку качества продукции. На все поставляемые продукты мы предоставляем гарантию .

Осуществляем поставки продукции под контролем ВП МО РФ на предприятия военно-промышленного комплекса России , а также работаем в рамках 275 ФЗ с открытием отдельных счетов в уполномоченном банке. Система менеджмента качества компании соответствует требованиям ГОСТ ISO 9001.

Минимальные сроки поставки, гибкие цены, неограниченный ассортимент и индивидуальный подход к клиентам являются основой для выстраивания долгосрочного и эффективного сотрудничества с предприятиями радиоэлектронной промышленности, предприятиями ВПК и научно-исследовательскими институтами России.

С нами вы становитесь еще успешнее!

Наши контакты:

Телефон: +7 812 627 14 35

Электронная почта: sales@st-electron.ru

Адрес: 198099, Санкт-Петербург,
Промышленная ул, дом № 19, литера Н,
помещение 100-Н Офис 331