

# TA31136FG, TA31136FNG

## FM IF DETECTOR IC FOR CORDLESS TELEPHONE

Low operation voltage FM IF detector IC. This IC is suitable for cordless telephone.

### FEATURES

- Low operating voltage :  $V_{CC} = 1.8 \sim 5.5V$
- Excellent temperature characteristics
- High sensitivity  
12dB sensitivity :  $11dB\mu V$  EMF (Input  $50\Omega$ )
- High intercept point :  $96dB\mu V$  (Input  $50\Omega$ )
- Quadrature detector, both ceramic and coil discriminators are usable
- Built-in 2nd MIX  
Operating frequency :  $10 \sim 100MHz$
- Built-in noise detection circuit
- RSSI function
- Very small package

### BLOCK DIAGRAM

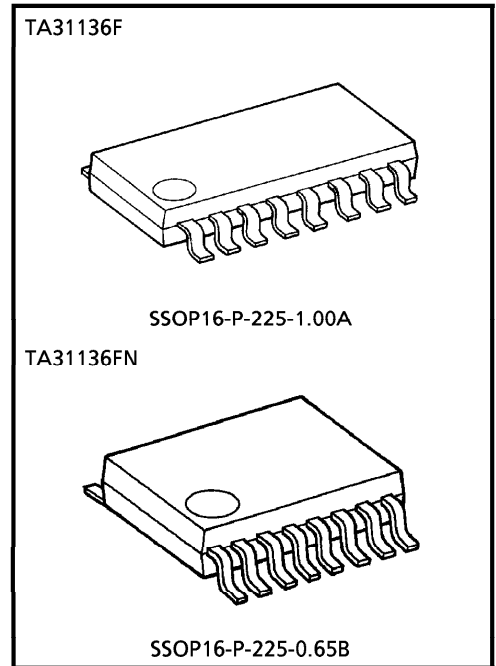
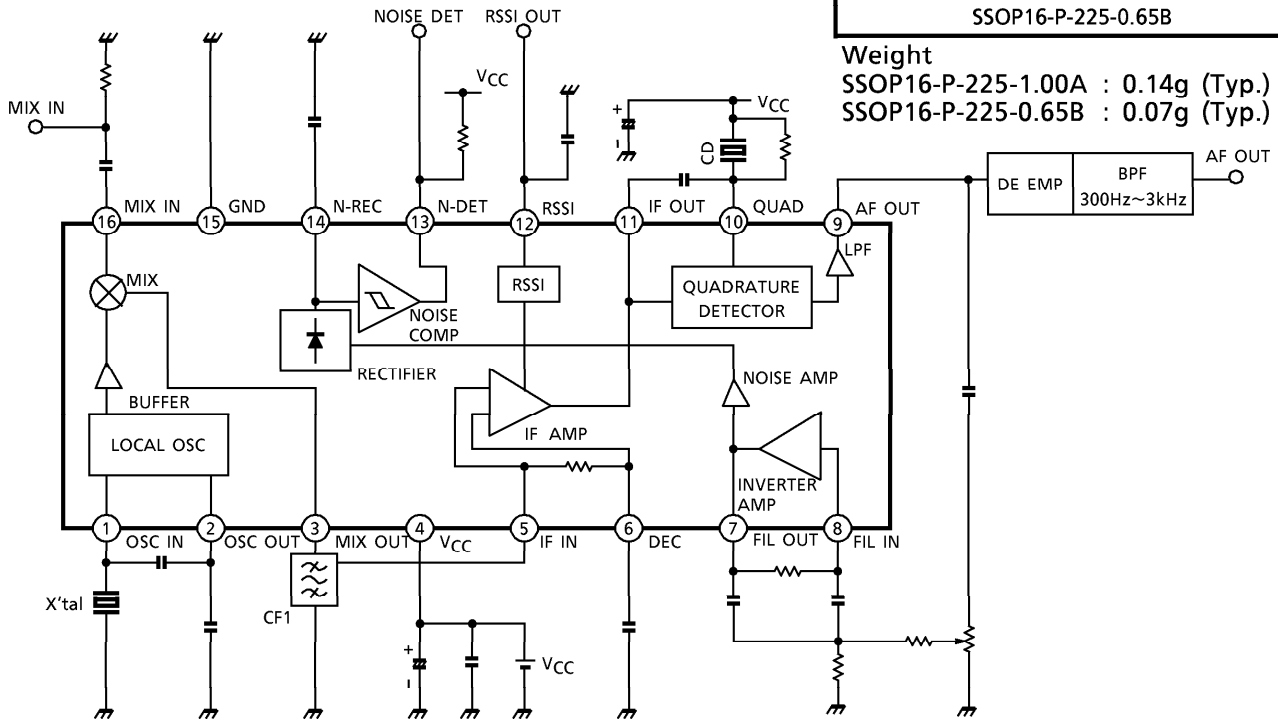

Weight  
SSOP16-P-225-1.00A : 0.14g (Typ.)  
SSOP16-P-225-0.65B : 0.07g (Typ.)

TA31136FNG Package is Pb-Free.

**PIN FUNCTION** (The values of resistor and capacitor are typical.)

PIN No.	PIN NAME	FUNCTION	INTERNAL EQUIVALENT CIRCUIT
1	OSC IN	Local oscillator input and output terminals. Colpitts oscillator is formed by internal emitter follower and external X'tal. And external injection is possible from pin 2 or pin 1.	
2	OSC OUT		
3	MIX OUT	MIX output terminal. Output impedance is around 1.8kΩ.	
4	VCC	Power supply	—
5	IF IN	2nd IF input and decoupling for bias. Input impedance is around 1.8kΩ.	
6	DEC		
7	FIL OUT	INVERTER AMP input and output terminals. BPF is composed of external capacitors and resistors. Connected internally to rectifier circuit by coupling capacitor.	
8	FIL IN		
9	AF OUT	Demodulate signal output terminal. Carrier leak is small as LPF is built-in. Output impedance is around 360Ω.	

PIN No.	PIN NAME	FUNCTION	INTERNAL EQUIVALENT CIRCUIT
10	QUAD	Phase shift signal input terminal of FM demodulator.	
11	IF OUT	Output terminal of IF AMP.	
12	RSSI	This terminal outputs DC level according to input signal level to IF AMP. Dynamic range is around 70dB.	
13	N-DET	The result of noise detection is output by comparing output voltage of N-REC terminal with internal reference. Hysteresis range is about 100mV and output is open collector.	
14	N-REC	After output of INVERTER AMP amplified around 20dB, noise signal is rectified by external capacitor.	
15	GND	GND terminal.	
16	MIX IN	1st IF signal input terminal. Input impedance is around 4kΩ at 21.7MHz.	

DESCRIPTION

1. Local oscillator external injection method

Inject as shown in Figure 1, setting the injection level between 95dB $\mu$ V and 100dB $\mu$ V. A built-in BUFFER amp. minimizes leakage from the mixer.

Input from pin 1 is possible as shown in Figure 2. However, when the input frequency is high, the level at pin 2 may not be sufficient, causing a decrease in sensitivity.

In such a case, add resistor R<sub>51</sub> and set the input signal so that signal level at pin 2 is 95~100dB $\mu$ V.

The input capacitance of pins 1 and 2 is respectively 1.5pF (typ.) and 4.6pF (typ.).

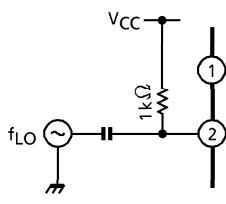

Figure 1

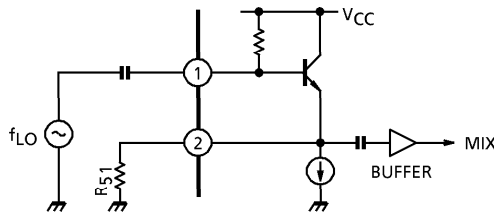

Figure 2

2. Overtone oscillation

Figure 3 shows the basic configuration of the local oscillation circuit using overtone oscillation. The C<sub>51</sub> and L<sub>1</sub> tuning circuits prevent crystal fundamental oscillation. Therefore, set C<sub>51</sub> and L<sub>1</sub> to inductive at the fundamental frequency and capacitive at the overtone frequency.

Since the level at pin 2 may decrease and the sensitivity may fall at high frequency as with external injection, adjust the oscillation level using R<sub>51</sub>.

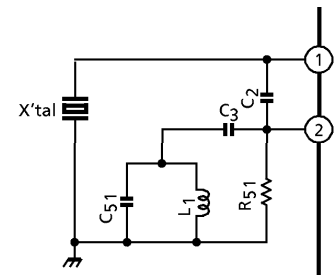

Figure 3

3. Detection circuit

Detection stage is quadrature method.

Oscillator is ceramic discriminator on reference application. In case of using coil, connect as shown in Figure 4. In this case, demodulation output V<sub>OD</sub> is about 80mV<sub>rms</sub>. Demodulation output can be increased by raising damping resistance R<sub>3</sub>. However, be careful because the temperature dependency of the modulation output also increases.

Center frequency f<sub>0</sub> and demodulation output depends largely on phase shifter and C<sub>7</sub>. For C<sub>7</sub>, use a capacitor with good temperature characteristics.

In case of coil, especially C<sub>101</sub>, use a capacitor with good temperature characteristics.

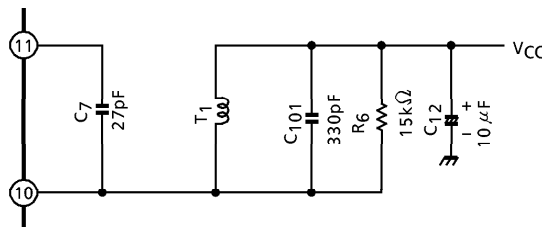

T<sub>1</sub> : 5114-JPS-010 (SUMIDA)

Figure 4

4. Demodulation output distortion factor

Demodulation output distortion factor is about -43dB when ceramic discriminator CDB450C24 used, is about -50dB when coil 5114-JPS-010 used. (IF 100dB $\mu$ V EMF input, measured pin 9 before when input from MIX demodulation output distortion factor depends largely on a ceramic filter band and a group delay characteristic. Select ceramic filter adequately.

5. INVERTER AMP usage

The INVERTER AMP can be used to form a band pass filter as shown in Figure 4.

Set constants as in equations (1) to (3). However, because a low pass filter and a high pass filter are built in, it is recommended that center frequency  $f_0$  be about 30kHz.

$$(1) \quad f_0 = \frac{1}{2\pi\sqrt{R_3(R_4 // R_5)C^2}}$$

$$(2) \quad G_V = R_3 / 2R_4$$

$$(3) \quad Q^2 = \frac{R_3}{4(R_4 // R_5)}$$

at  $R_4 \gg R_p$

Example  $R_3 = 150k\Omega$ ,  $R_4 = 330k\Omega$ ,  
 $R_5 = 3.3k\Omega$ ,  $R_p = 20k\Omega$  (VR)  
 $C = 220pF$  provide ;  
 $f_0 \approx 31kHz$ ,  $G_V \approx -13dB$   
 $Q \approx 12$

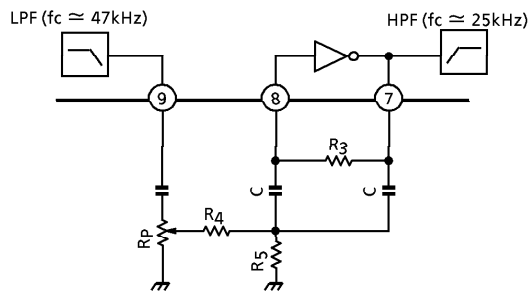

Figure 5

6. Noise detection rise time

The rise time is a proportion of time constant 7.5ms of the smoothing capacitor  $C_g = 0.1\mu F$  of the noise rectifier and internal resistor  $75k\Omega$ . Although decreasing the capacitance of  $C_g$  can shorten the rise time, note that the noise detection output fluctuation may increase. This should be taken into account before use.

7. RSSI function

A DC voltage corresponding to the input level of IF input pins (pin 5) is output to the RSSI pin (P21). While the linear range is about 80dB when  $V_{CC} = 2V$ , the range can be expanded to 80dB as in Figure 6.

However, in such a case, note that the temperature characteristics of the RSSI output may alter due to a disparity between the temperature coefficient of the external resistor and the internal resistance of the IC.

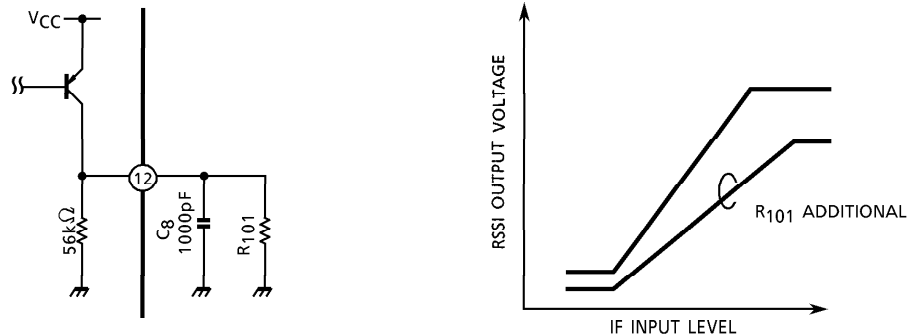

Figure 6

8. DC voltages for pins (Typical values for reference)

$V_{CC} = 2.0V$

PIN No.	PIN NAME	VOLTAGE	PIN No.	PIN NAME	VOLTAGE
1	OCS IN	1.98	9	AF OUT	—
2	OSC OUT	1.33	10	QUAD	2.0
3	MIX OUT	0.74	11	IF OUT	1.14
4	$V_{CC}$	2.0	12	RSSI	—
5	IF IN	1.67	13	N-DET	—
6	DEC	1.67	14	N-REC	—
7	FIL OUT	0.67	15	GND	0.0
8	FIL IN	0.65	16	MIX IN	0.94

(UNIT : V)

## MAXIMUM RATINGS (Ta = 25°C)

CHARACTERISTIC	SYMBOL	RATING	UNIT
Supply Voltage	V <sub>CC</sub>	7	V
Power Dissipation	TA31136F	370	mW
	TA31136FN	560	
Operating Temperature	T <sub>opr</sub>	-30~85	°C
Storage Temperature	T <sub>stg</sub>	-50~150	°C

## ELECTRICAL CHARACTERISTICS

( Unless otherwise specified, V<sub>CC</sub> = 2.0V, f<sub>IN</sub> (MIX) = 21.7MHz, f<sub>IN</sub> (IF) = 450kHz, Δf = ±1.5kHz, f<sub>MOD</sub> = 1kHz, Ta = 25°C )

CHARACTERISTIC	SYMBOL	TEST CIR-CUIT	TEST CONDITION	MIN.	TYP.	MAX.	UNIT
Power Supply Voltage	V <sub>CC</sub>	—	—	1.8	2.0	5.5	V
Current Consumption	I <sub>CCQ</sub>	1	—	—	3.2	4.6	mA
Mixer Conversion Gain	G <sub>VC</sub>	2	Measured through ceramic filter. V <sub>IN</sub> (MIX) = 46dB <sub>μV</sub>	15	18	21	dB
Mixer Intercept Point	P <sub>IM</sub>	—	Input 50Ω	—	96	—	dB <sub>μV</sub>
Mixer Input Impedance	R <sub>IN</sub> (MIX)	—	—	—	5.5	—	kΩ
	C <sub>IN</sub> (MIX)	—		—	2.8	—	pF
Mixer Output Resistance	R <sub>O</sub> (MIX)	—	—	1.2	1.8	2.4	kΩ
12dB Sensitivity	12dB SN	—	—	—	11	—	dB <sub>μV</sub>
Demodulation Output Level	V <sub>OD</sub>	2	V <sub>IN</sub> (IF) = 80dB <sub>μV</sub>	70	100	130	mV <sub>rms</sub>
SN Ratio	SN	2	V <sub>IN</sub> (IF) = 80dB <sub>μV</sub>	43	65	—	dB
AM Rejection Ratio	AMR	2	V <sub>IN</sub> (IF) = 80dB <sub>μV</sub> , AM = 30%	—	40	—	dB
IF AMP. Input Resistance	R <sub>IN</sub> (IF)	—	—	1.2	1.8	2.4	kΩ
RSSI Output Voltage	V <sub>RSSI-1</sub>	2	V <sub>CC</sub> = 3V V <sub>IN</sub> (IF) = 30dB <sub>μV</sub> V <sub>IN</sub> (IF) = 100dB <sub>μV</sub>	200	360	520	mV
	V <sub>RSSI-2</sub>	2		1.4	2.0	2.6	V
Noise Detection Output Voltage	V <sub>NDET</sub>	2	I <sub>SINK</sub> = 0.2mA	—	0.1	0.5	V
Noise Detection Output Leak Current	I <sub>LEAK</sub>	—	V <sub>NREC</sub> = 0.6V, V <sub>NDET</sub> = 2V	—	0	5	μA
Noise Detection Level	"H" Level	V <sub>TH-H</sub>	—	—	0.5	0.7	V
	"L" Level	V <sub>TH-L</sub>		0.3	0.4	—	

All AC levels are indicated by open level (EMF).

TEST CIRCUIT 1

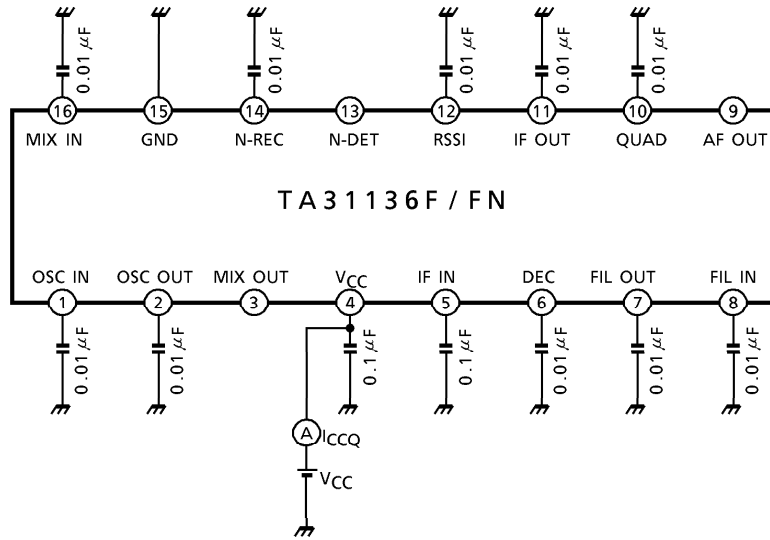

TEST CIRCUIT 2

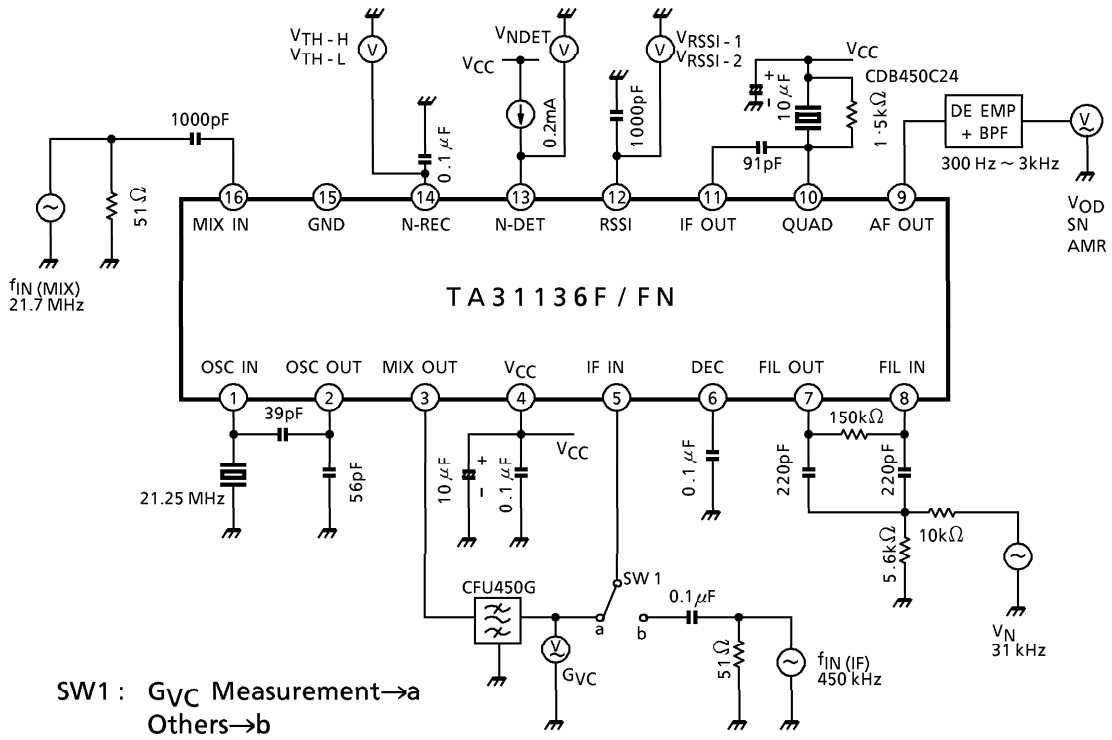



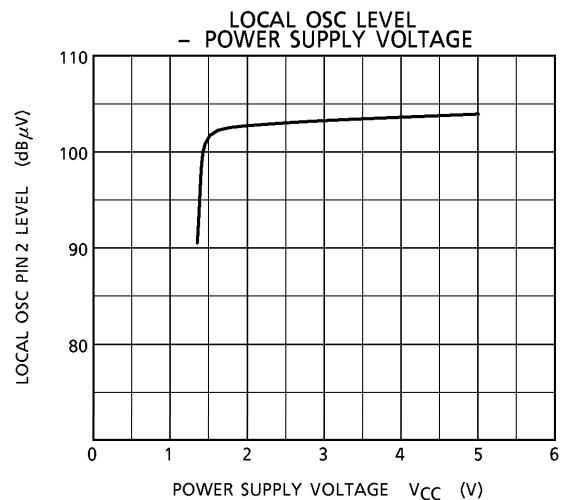
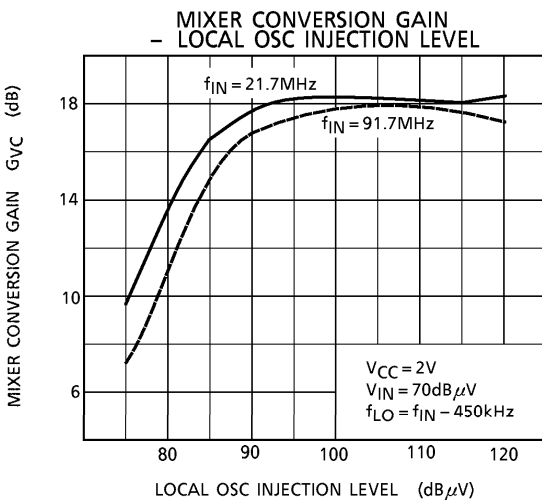
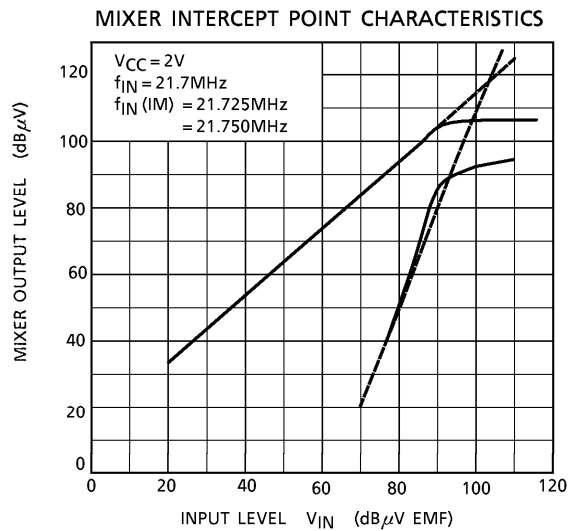
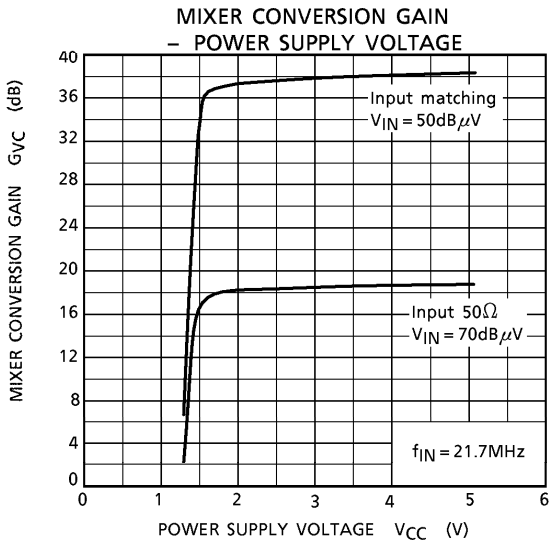
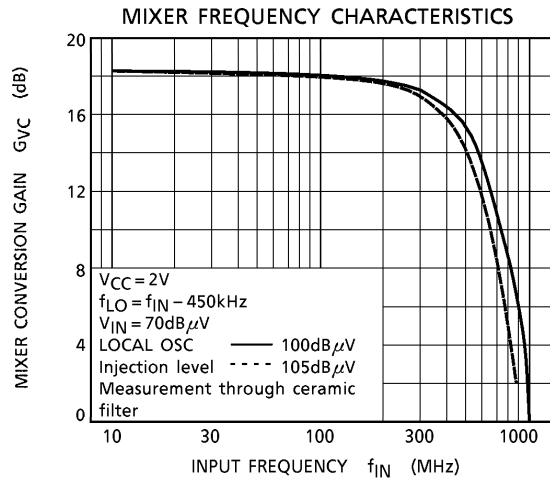
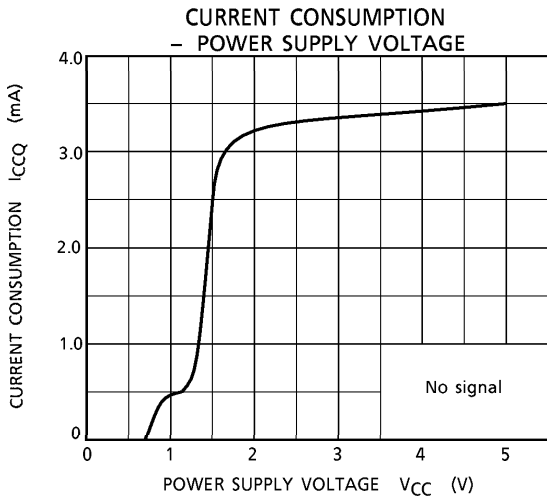

MIXER INPUT DEMODULATION CHARACTERISTICS

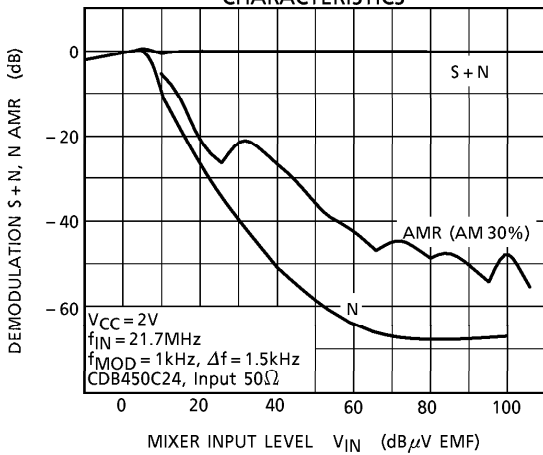

DEMODULATION OUTPUT LEVEL  $V_{OD}$ , 12dB SENSITIVITY - POWER SUPPLY VOLTAGE

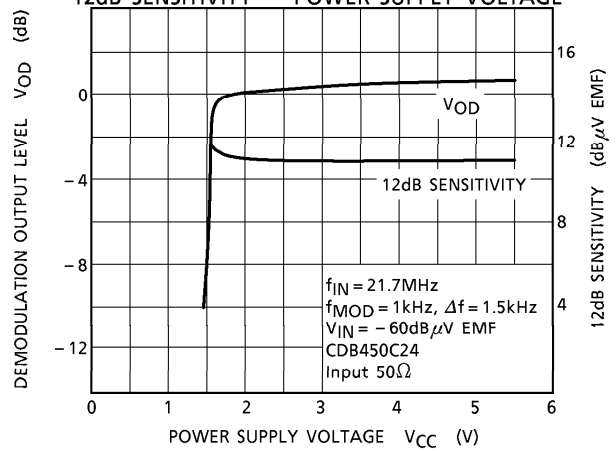

IF INPUT DEMODULATION CHARACTERISTICS

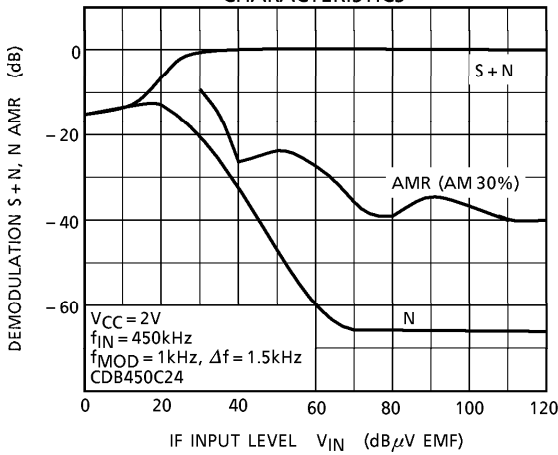

IF INPUT DETUNING CHARACTERISTICS

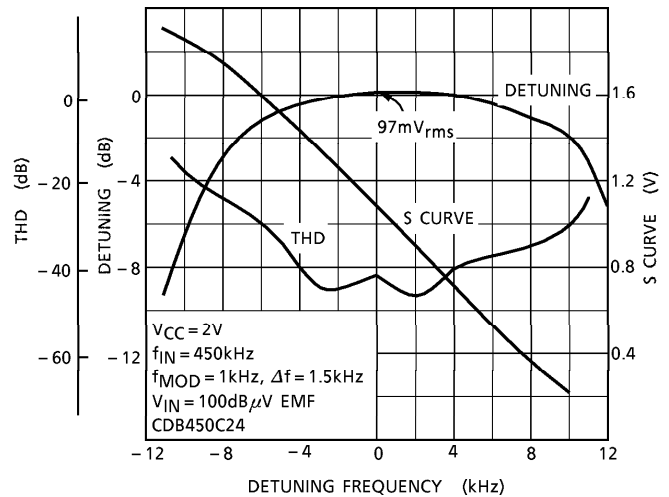

DEMODULATION OUTPUT LEVEL TEMPERATURE CHARACTERISTICS

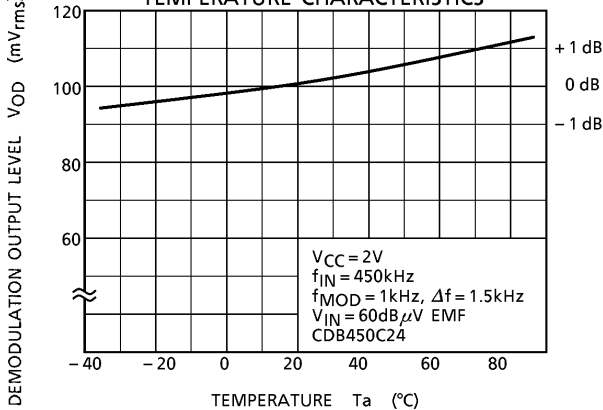

IF AMP GAIN FREQUENCY CHARACTERISTICS

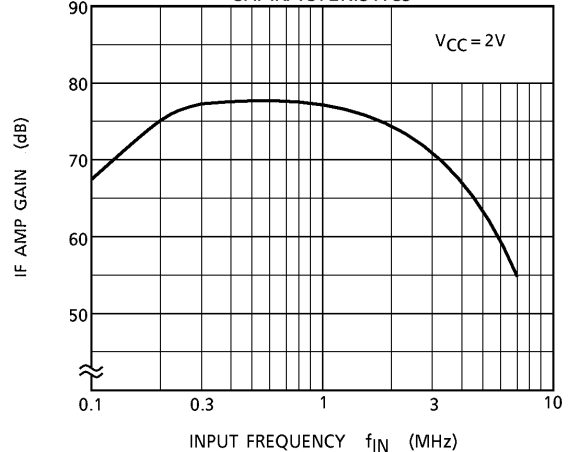

IN COIL DISCRIMINATER USED

MIXER INPUT DEMODULATION CHARACTERISTICS

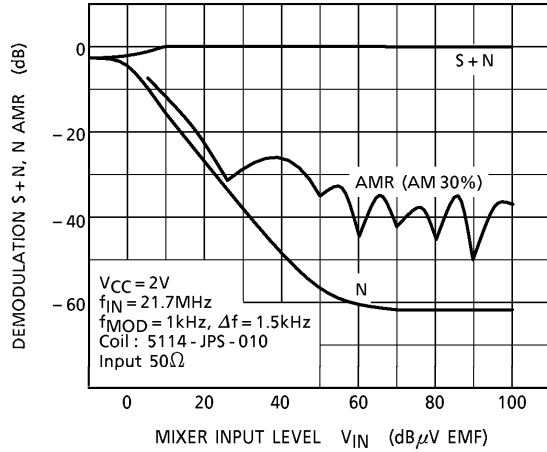

IF INPUT DEMODULATION CHARACTERISTICS

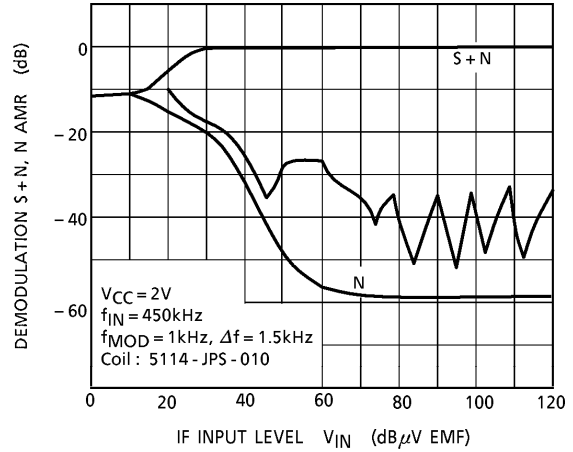

IF DETUNING CHARACTERISTICS

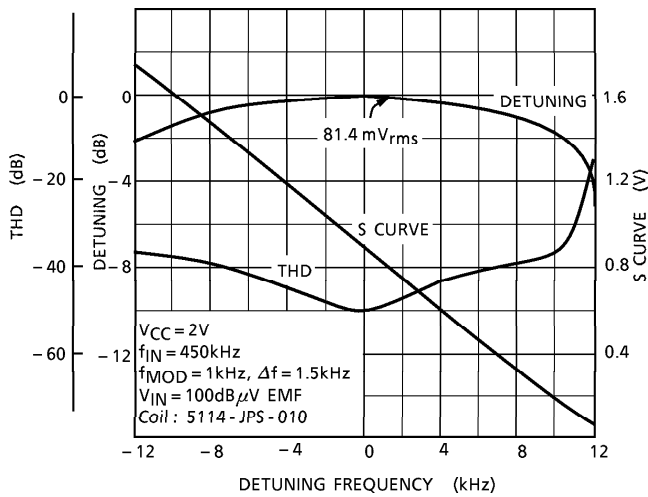

MIXER INPUT RSSI CHARACTERISTICS

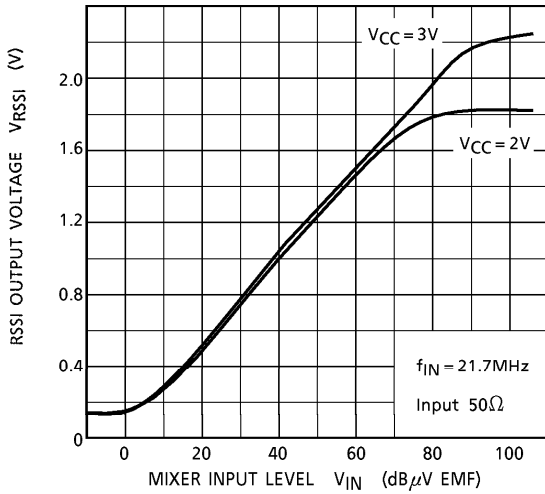

IF INPUT RSSI CHARACTERISTICS

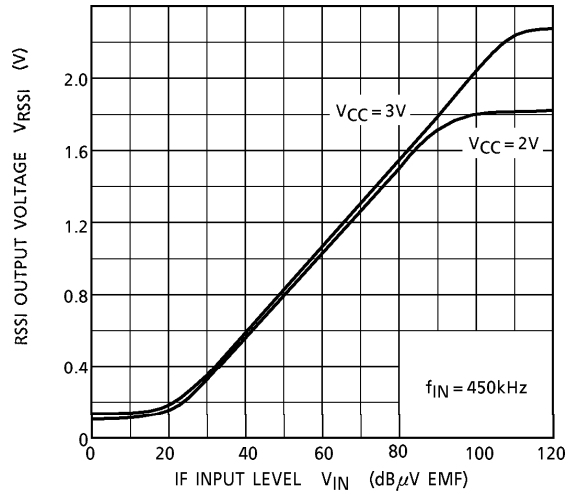

MIXER INPUT RSSI TEMPERATURE CHARACTERISTICS

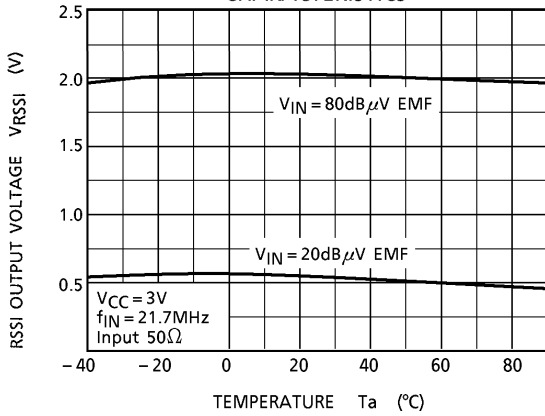

IF INPUT RSSI TEMPERATURE CHARACTERISTICS

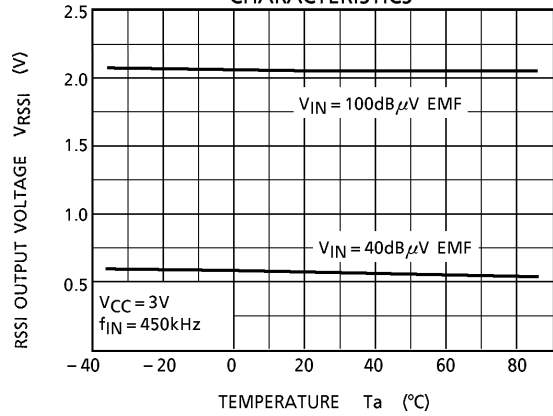

NOISE DETECTION CHARACTERISTICS

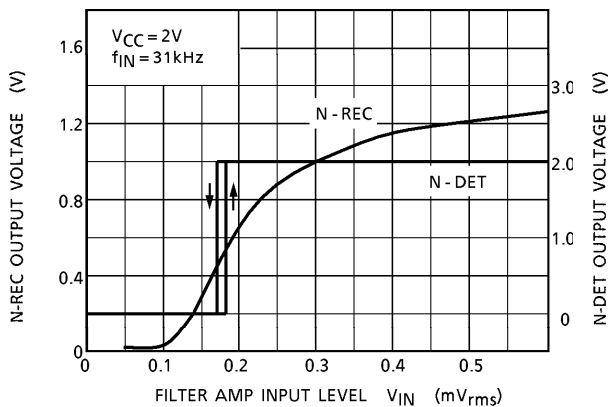

NOISE DETECTION TEMPERATURE CHARACTERISTICS

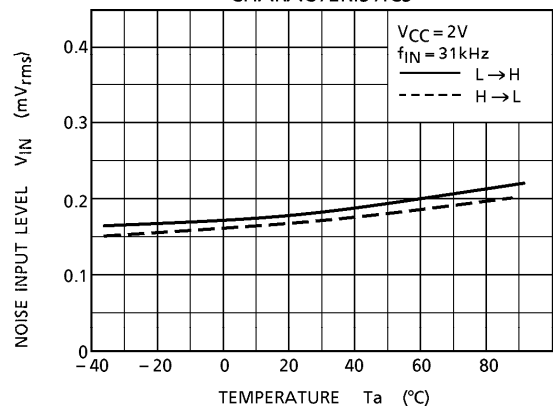

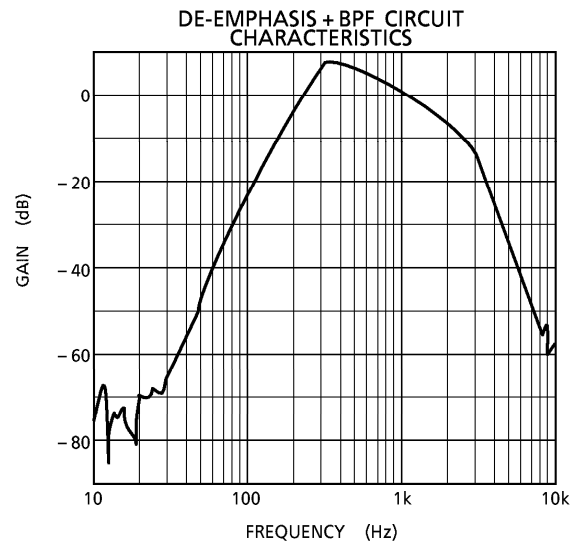
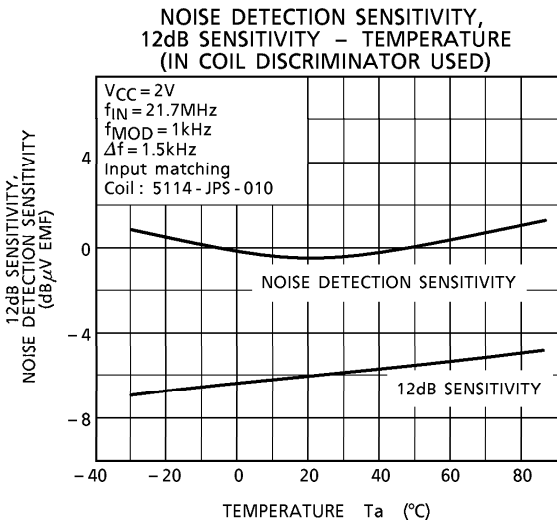
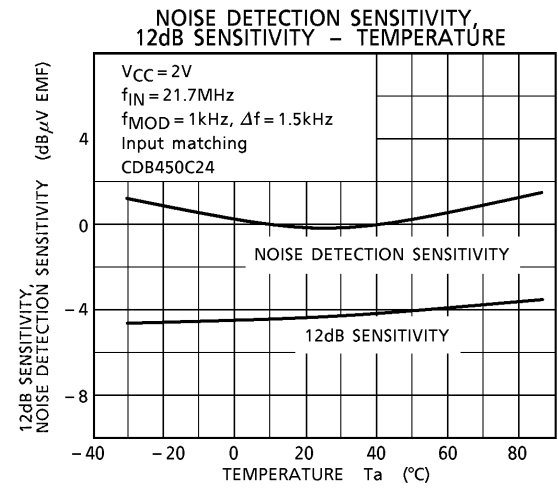
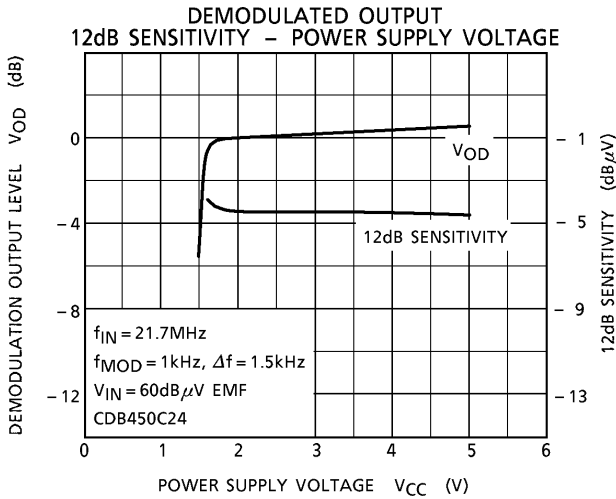
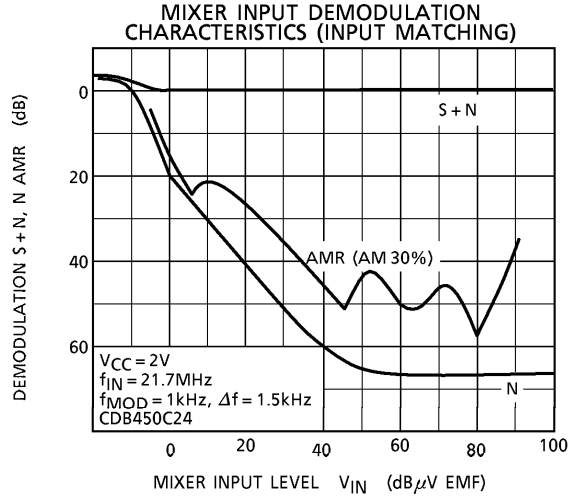
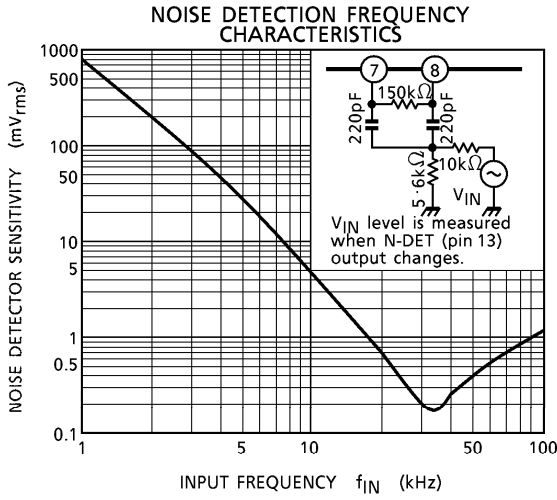

APPLICATION CIRCUIT

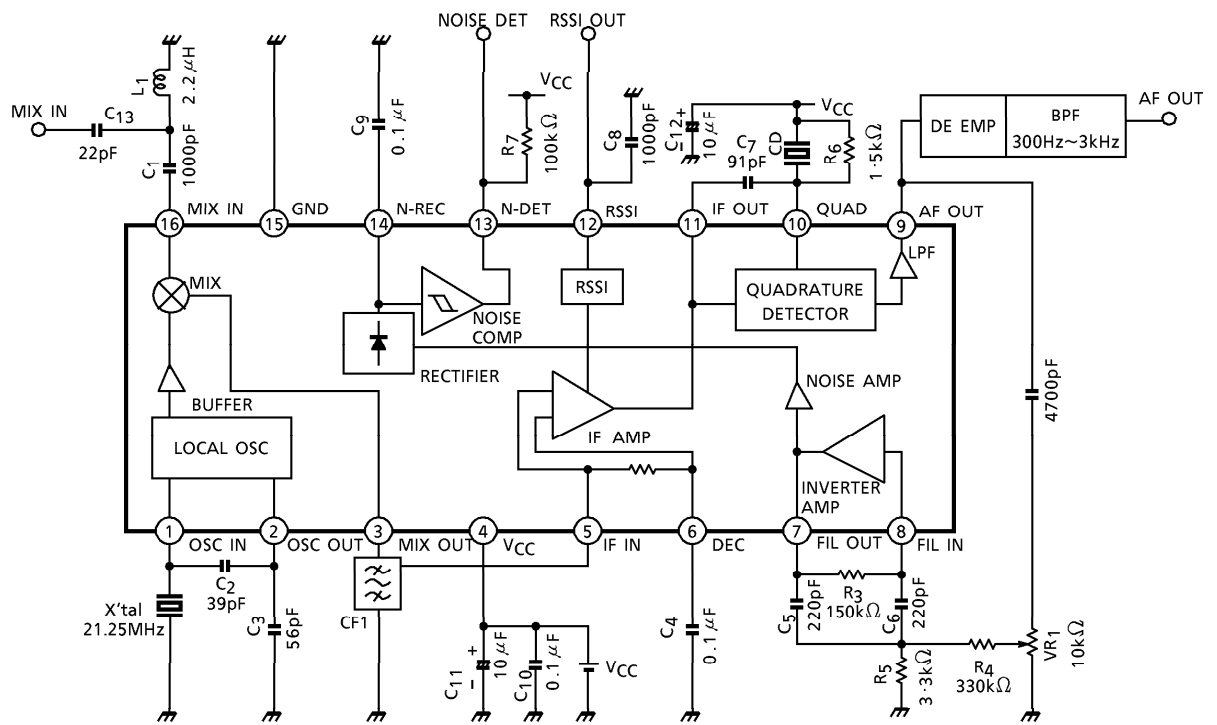

CD : CDB450C24 (MURATA)  
 CF1 : CFW450G (MURATA)

**PACKAGE DIMENSIONS**  
SSOP16-P-225-1.00A

Unit : mm

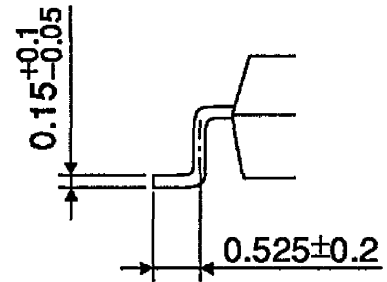
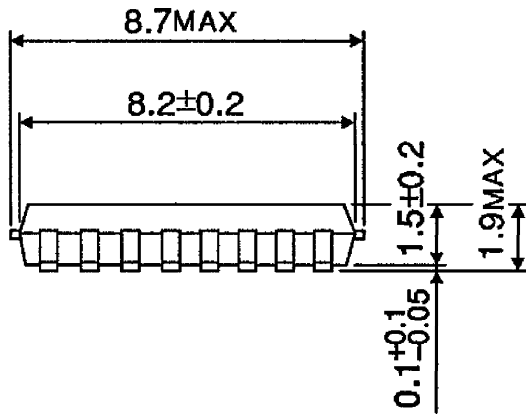
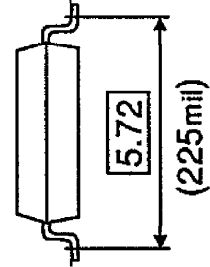
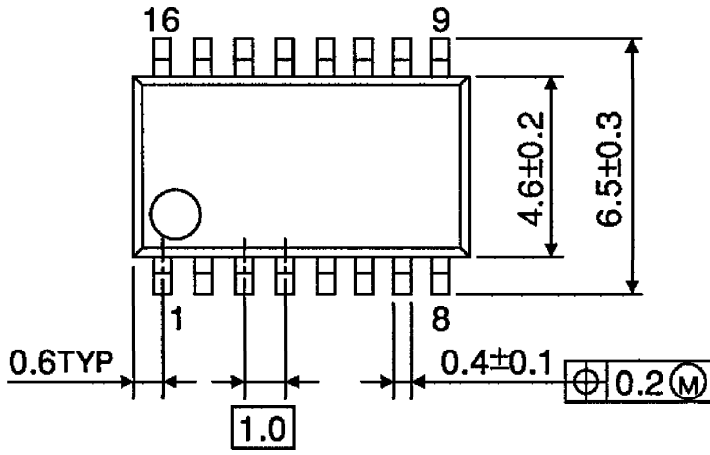

Weight : 0.14g (Typ.)

**PACKAGE DIMENSIONS**  
SSOP16-P-225-0.65B

Unit : mm

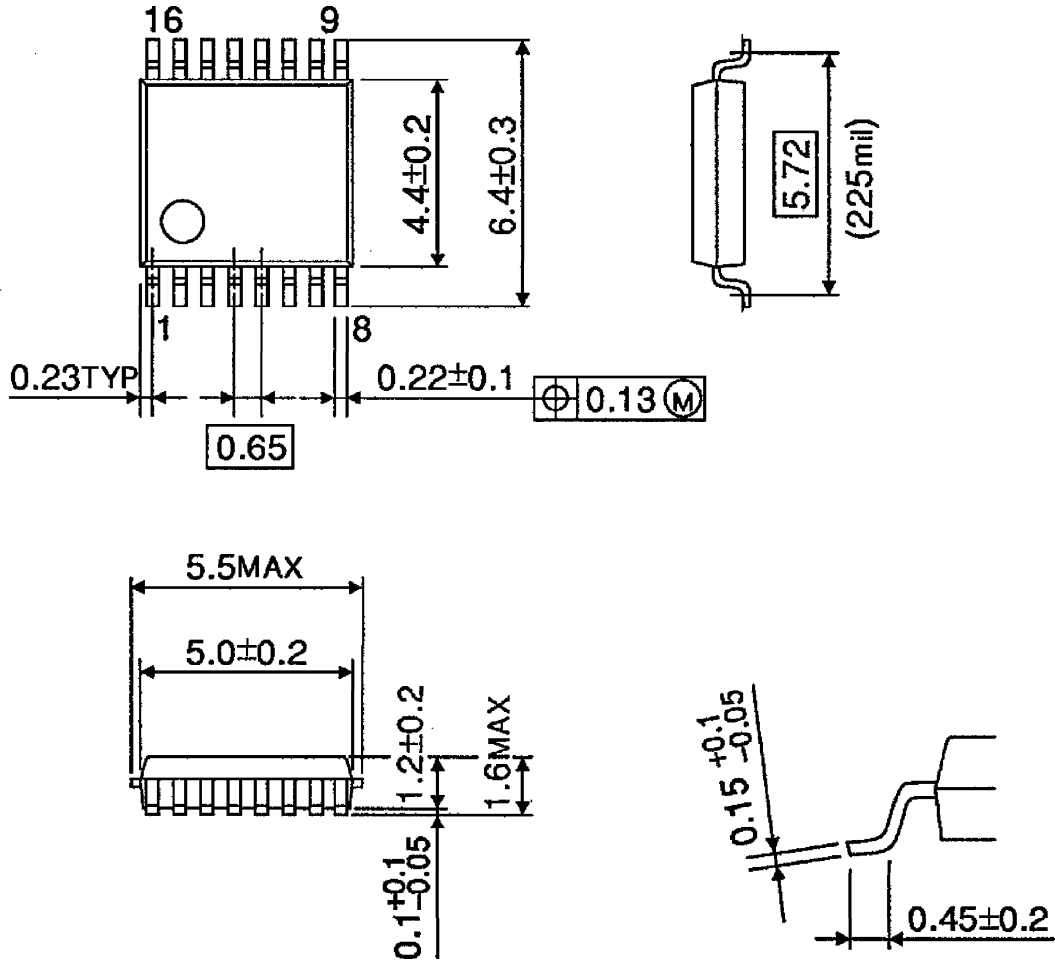

Weight : 0.07g (Typ.)



## Notice for Pb free product

About solderability, following conditions were confirmed

## Solderability

- (1) Use of Sn-63Pb solder bath
  - Solder bath temperature = 230
  - Dipping time = 5seconds
  - The number of times = once
  - Use of R-type flux
- (2) Use of Sn-3.0Ag-0.5Cu solder bath
  - Solder bath temperature = 245
  - Dipping time = 5seconds
  - The number of times = once
  - Use of R-type flux

**RESTRICTIONS ON PRODUCT USE**

000707EBA

- TOSHIBA is continually working to improve the quality and reliability of its products. Nevertheless, semiconductor devices in general can malfunction or fail due to their inherent electrical sensitivity and vulnerability to physical stress. It is the responsibility of the buyer, when utilizing TOSHIBA products, to comply with the standards of safety in making a safe design for the entire system, and to avoid situations in which a malfunction or failure of such TOSHIBA products could cause loss of human life, bodily injury or damage to property. In developing your designs, please ensure that TOSHIBA products are used within specified operating ranges as set forth in the most recent TOSHIBA products specifications. Also, please keep in mind the precautions and conditions set forth in the "Handling Guide for Semiconductor Devices," or "TOSHIBA Semiconductor Reliability Handbook" etc..
- The TOSHIBA products listed in this document are intended for usage in general electronics applications (computer, personal equipment, office equipment, measuring equipment, industrial robotics, domestic appliances, etc.). These TOSHIBA products are neither intended nor warranted for usage in equipment that requires extraordinarily high quality and/or reliability or a malfunction or failure of which may cause loss of human life or bodily injury ("Unintended Usage"). Unintended Usage include atomic energy control instruments, airplane or spaceship instruments, transportation instruments, traffic signal instruments, combustion control instruments, medical instruments, all types of safety devices, etc.. Unintended Usage of TOSHIBA products listed in this document shall be made at the customer's own risk.
- The products described in this document are subject to the foreign exchange and foreign trade laws.
- The information contained herein is presented only as a guide for the applications of our products. No responsibility is assumed by TOSHIBA CORPORATION for any infringements of intellectual property or other rights of the third parties which may result from its use. No license is granted by implication or otherwise under any intellectual property or other rights of TOSHIBA CORPORATION or others.
- The information contained herein is subject to change without notice.



## Стандарт Электрон Связь

Мы молодая и активно развивающаяся компания в области поставок электронных компонентов. Мы поставляем электронные компоненты отечественного и импортного производства напрямую от производителей и с крупнейших складов мира.

Благодаря сотрудничеству с мировыми поставщиками мы осуществляем комплексные и плановые поставки широчайшего спектра электронных компонентов.

Собственная эффективная логистика и склад в обеспечивает надежную поставку продукции в точно указанные сроки по всей России.

Мы осуществляем техническую поддержку нашим клиентам и предпродажную проверку качества продукции. На все поставляемые продукты мы предоставляем гарантию .

Осуществляем поставки продукции под контролем ВП МО РФ на предприятия военно-промышленного комплекса России , а также работаем в рамках 275 ФЗ с открытием отдельных счетов в уполномоченном банке. Система менеджмента качества компании соответствует требованиям ГОСТ ISO 9001.

Минимальные сроки поставки, гибкие цены, неограниченный ассортимент и индивидуальный подход к клиентам являются основой для выстраивания долгосрочного и эффективного сотрудничества с предприятиями радиоэлектронной промышленности, предприятиями ВПК и научно-исследовательскими институтами России.

С нами вы становитесь еще успешнее!

### Наши контакты:

**Телефон:** +7 812 627 14 35

**Электронная почта:** [sales@st-electron.ru](mailto:sales@st-electron.ru)

**Адрес:** 198099, Санкт-Петербург,  
Промышленная ул, дом № 19, литера Н,  
помещение 100-Н Офис 331