

POWER MOS 7® IGBT

The POWER MOS 7® IGBT is a new generation of high voltage power IGBTs. Using Punch Through Technology this IGBT is ideal for many high frequency, high voltage switching applications and has been optimized for high frequency switchmode power supplies.

- Low Conduction Loss
- Low Gate Charge
- Ultrafast Tail Current shutoff
- 100 kHz operation @ 400V, 41A
- 200 kHz operation @ 400V, 26A
- SSOA rated

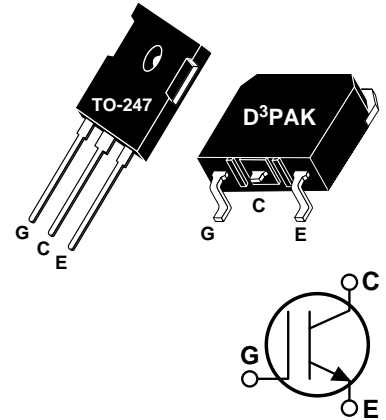

MAXIMUM RATINGS

All Ratings: $T_C = 25^\circ\text{C}$ unless otherwise specified.

Symbol	Parameter	APT40GP60B_S	UNIT
V_{CES}	Collector-Emitter Voltage	600	Volts
V_{GE}	Gate-Emitter Voltage	± 20	
V_{GEM}	Gate-Emitter Voltage Transient	± 30	
I_{C1}	Continuous Collector Current ^⑦ @ $T_C = 25^\circ\text{C}$	100	Amps
I_{C2}	Continuous Collector Current @ $T_C = 110^\circ\text{C}$	62	
I_{CM}	Pulsed Collector Current ^① @ $T_C = 150^\circ\text{C}$	160	
SSOA	Switching Safe Operating Area @ $T_J = 150^\circ\text{C}$	160A @ 600V	
P_D	Total Power Dissipation	543	Watts
T_J, T_{STG}	Operating and Storage Junction Temperature Range	-55 to 150	$^\circ\text{C}$
T_L	Max. Lead Temp. for Soldering: 0.063" from Case for 10 Sec.	300	

STATIC ELECTRICAL CHARACTERISTICS

Symbol	Characteristic / Test Conditions	MIN	TYP	MAX	UNIT
BV_{CES}	Collector-Emitter Breakdown Voltage ($V_{GE} = 0\text{V}, I_C = 250\mu\text{A}$)	600			Volts
$V_{GE(TH)}$	Gate Threshold Voltage ($V_{CE} = V_{GE}, I_C = 1\text{mA}, T_J = 25^\circ\text{C}$)	3	4.5	6	
$V_{CE(ON)}$	Collector-Emitter On Voltage ($V_{GE} = 15\text{V}, I_C = 40\text{A}, T_J = 25^\circ\text{C}$)		2.2	2.7	
	Collector-Emitter On Voltage ($V_{GE} = 15\text{V}, I_C = 40\text{A}, T_J = 125^\circ\text{C}$)		2.1		
I_{CES}	Collector Cut-off Current ($V_{CE} = 600\text{V}, V_{GE} = 0\text{V}, T_J = 25^\circ\text{C}$) ^②			250	μA
	Collector Cut-off Current ($V_{CE} = 600\text{V}, V_{GE} = 0\text{V}, T_J = 125^\circ\text{C}$) ^②			2500	
I_{GES}	Gate-Emitter Leakage Current ($V_{GE} = \pm 20\text{V}$)			± 100	nA

 **CAUTION:** These Devices are Sensitive to Electrostatic Discharge. Proper Handling Procedures Should Be Followed.

APT Website - <http://www.advancedpower.com>

DYNAMIC CHARACTERISTICS

APT40GP60B_S

Symbol	Characteristic	Test Conditions	MIN	TYP	MAX	UNIT
C_{ies}	Input Capacitance	Capacitance $V_{GE} = 0V, V_{CE} = 25V$ $f = 1 \text{ MHz}$		4610		pF
C_{oes}	Output Capacitance			395		
C_{res}	Reverse Transfer Capacitance			25		
V_{GEP}	Gate-to-Emitter Plateau Voltage	Gate Charge $V_{GE} = 15V$ $V_{CE} = 300V$ $I_C = 40A$		7.5		V
Q_g	Total Gate Charge ^③			135		nC
Q_{ge}	Gate-Emitter Charge			30		
Q_{gc}	Gate-Collector ("Miller") Charge			40		
SSOA	Switching SOA	$T_J = 150^\circ\text{C}, R_G = 5\Omega, V_{GE} = 15V, L = 100\mu\text{H}, V_{CE} = 600V$	160			A
$t_{d(on)}$	Turn-on Delay Time	Inductive Switching (25°C) $V_{CC}(\text{Peak}) = 400V$ $V_{GE} = 15V$ $I_C = 40A$ $R_G = 5\Omega$ $T_J = +25^\circ\text{C}$		20		ns
t_r	Current Rise Time			29		
$t_{d(off)}$	Turn-off Delay Time			64		
t_f	Current Fall Time			45		
E_{on1}	Turn-on Switching Energy ^④			385		μJ
E_{on2}	Turn-on Switching Energy (Diode) ^⑤			644		
E_{off}	Turn-off Switching Energy ^⑥			352	450	
$t_{d(on)}$	Turn-on Delay Time	Inductive Switching (125°C) $V_{CC}(\text{Peak}) = 400V$ $V_{GE} = 15V$ $I_C = 40A$ $R_G = 5\Omega$ $T_J = +125^\circ\text{C}$		20		ns
t_r	Current Rise Time			29		
$t_{d(off)}$	Turn-off Delay Time			89		
t_f	Current Fall Time			69		
E_{on1}	Turn-on Switching Energy ^④			385		μJ
E_{on2}	Turn-on Switching Energy (Diode) ^⑤			972		
E_{off}	Turn-off Switching Energy ^⑥			615	950	

THERMAL AND MECHANICAL CHARACTERISTICS

Symbol	Characteristic	MIN	TYP	MAX	UNIT
$R_{\theta JC}$	Junction to Case (IGBT)			.23	°C/W
$R_{\theta JC}$	Junction to Case (DIODE)			N/A	
W_T	Package Weight			5.90	gm

- ① Repetitive Rating: Pulse width limited by maximum junction temperature.
- ② For Combi devices, I_{ces} includes both IGBT and FRED leakages
- ③ See MIL-STD-750 Method 3471.
- ④ E_{on1} is the clamped inductive turn-on-energy of the IGBT only, without the effect of a commutating diode reverse recovery current adding to the IGBT turn-on loss. (See Figure24.)
- ⑤ E_{on2} is the clamped inductive turn-on energy that includes a commutating diode reverse recovery current in the IGBT turn-on switching loss. A Combi device is used for the clamping diode as shown in the E_{on2} test circuit. (See Figures 21, 22.)
- ⑥ E_{off} is the clamped inductive turn-off energy measured in accordance with JEDEC standard JESD24-1. (See Figures 21, 23.)
- ⑦ Continuous current limited by package lead temperature.
- APT Reserves the right to change, without notice, the specifications and information contained herein.**

TYPICAL PERFORMANCE CURVES

APT40GP60B_S

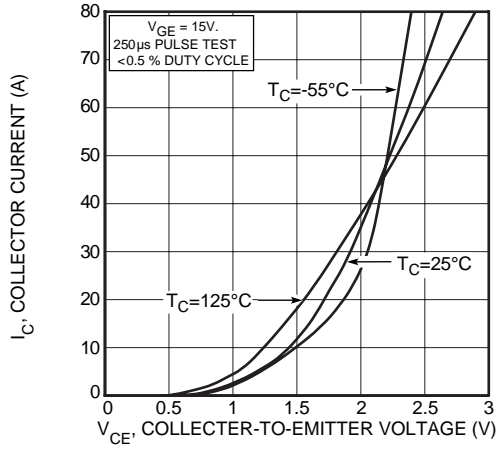

FIGURE 1, Output Characteristics ($V_{GE} = 15V$)

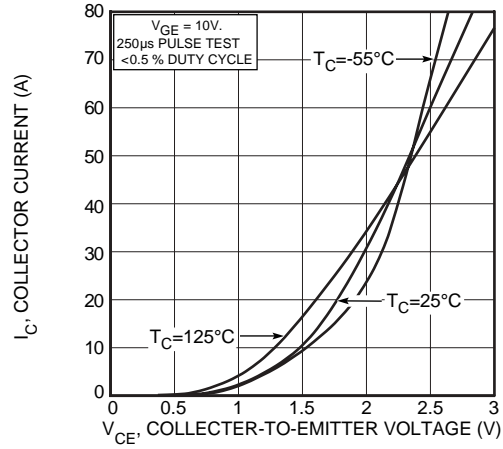

FIGURE 2, Output Characteristics ($V_{GE} = 10V$)

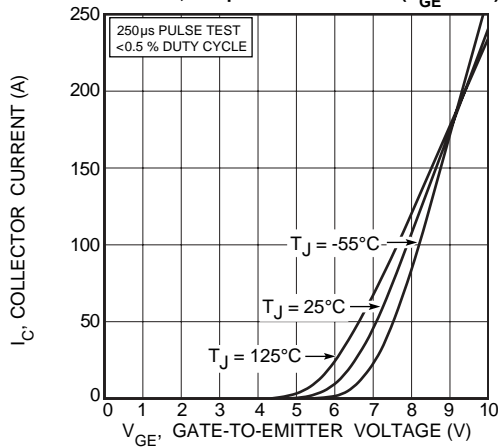

FIGURE 3, Transfer Characteristics

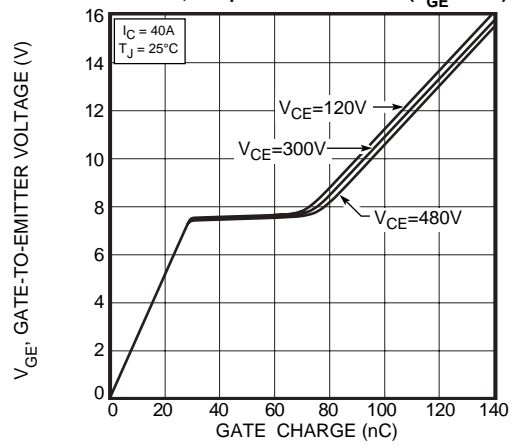

FIGURE 4, Gate Charge

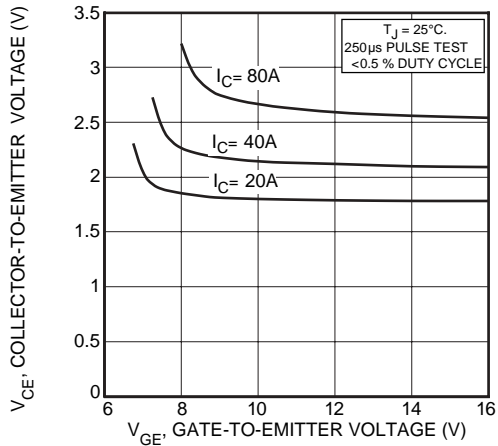

FIGURE 5, On State Voltage vs Gate-to-Emitter Voltage

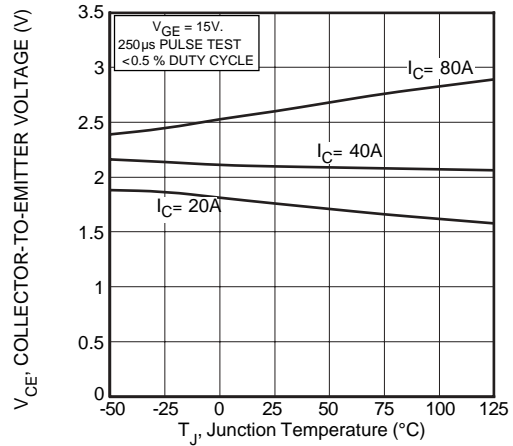

FIGURE 6, On State Voltage vs Junction Temperature

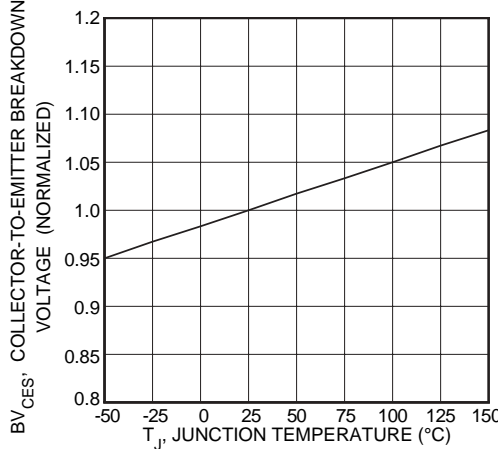

FIGURE 7, Breakdown Voltage vs. Junction Temperature

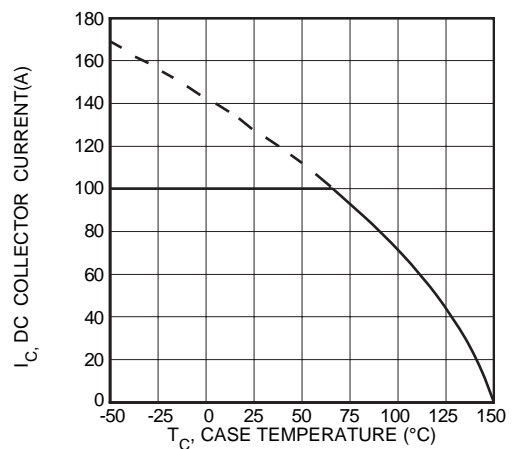

FIGURE 8, DC Collector Current vs Case Temperature

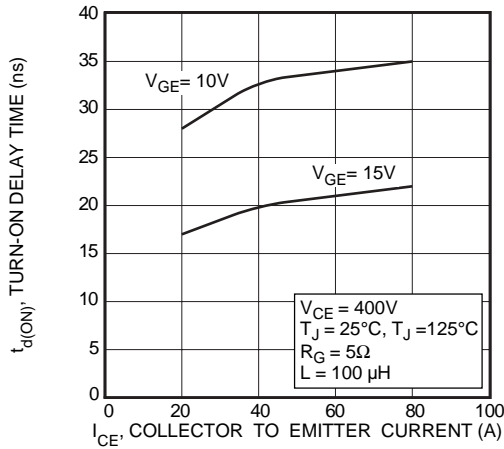

FIGURE 9, Turn-On Delay Time vs Collector Current

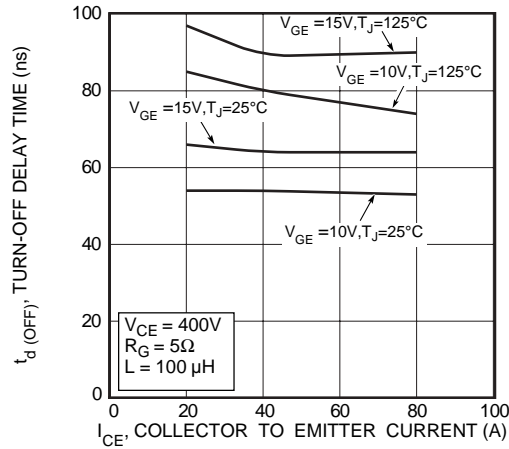

FIGURE 10, Turn-Off Delay Time vs Collector Current

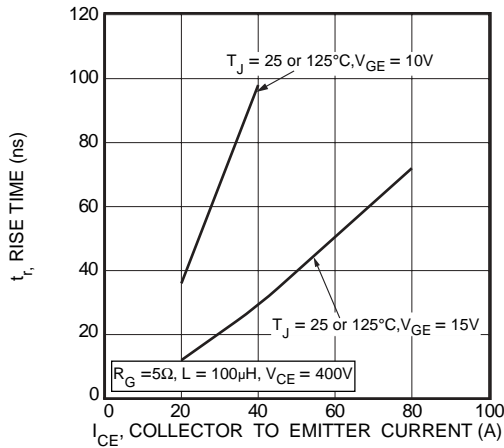

FIGURE 11, Current Rise Time vs Collector Current

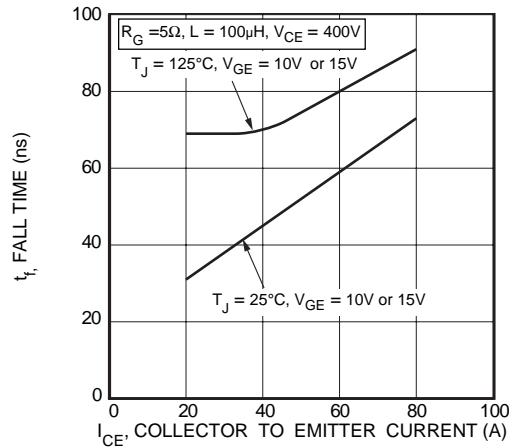

FIGURE 12, Current Fall Time vs Collector Current

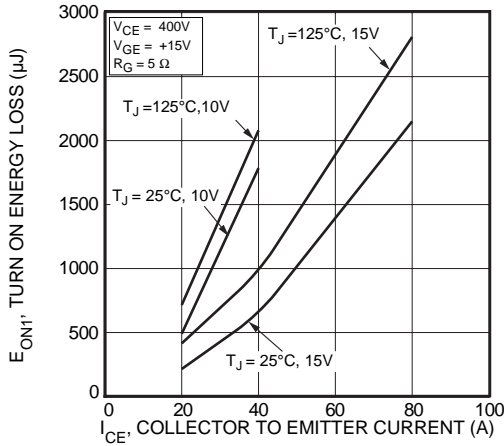

FIGURE 13, Turn-On Energy Loss vs Collector Current

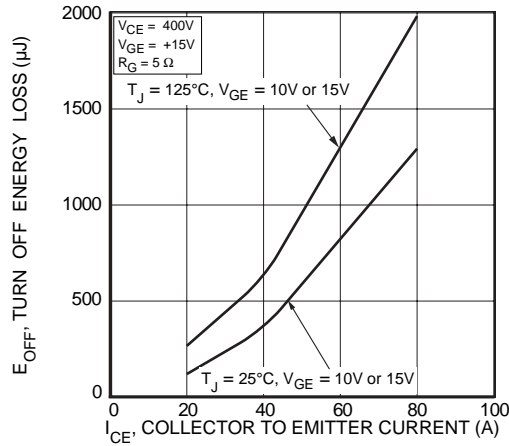

FIGURE 14, Turn Off Energy Loss vs Collector Current

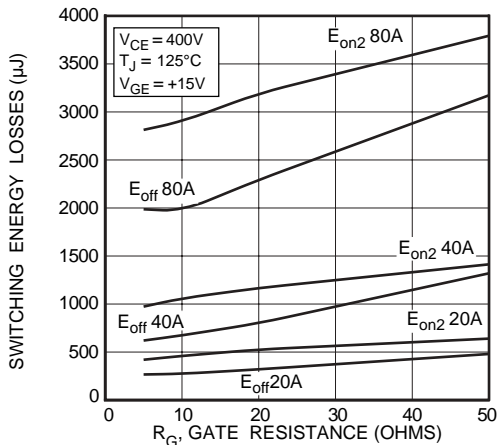

FIGURE 15, Switching Energy Losses vs. Gate Resistance

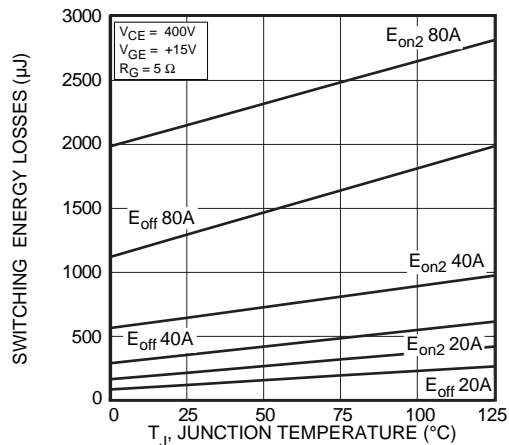

FIGURE 16, Switching Energy Losses vs Junction Temperature

TYPICAL PERFORMANCE CURVES

APT40GP60B_S

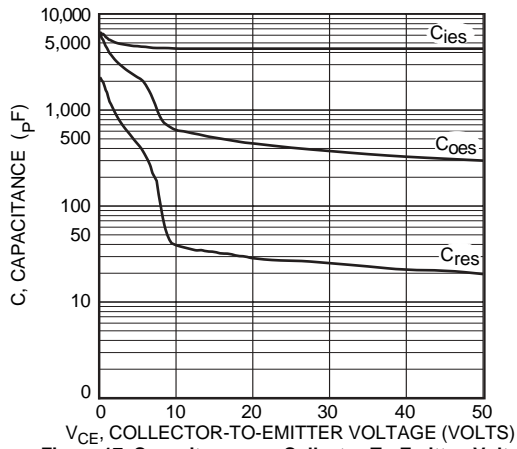

Figure 17, Capacitance vs Collector-To-Emitter Voltage

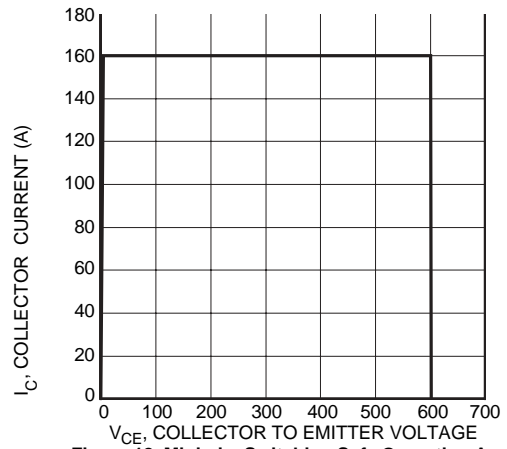

Figure 18, Minimum Switching Safe Operating Area

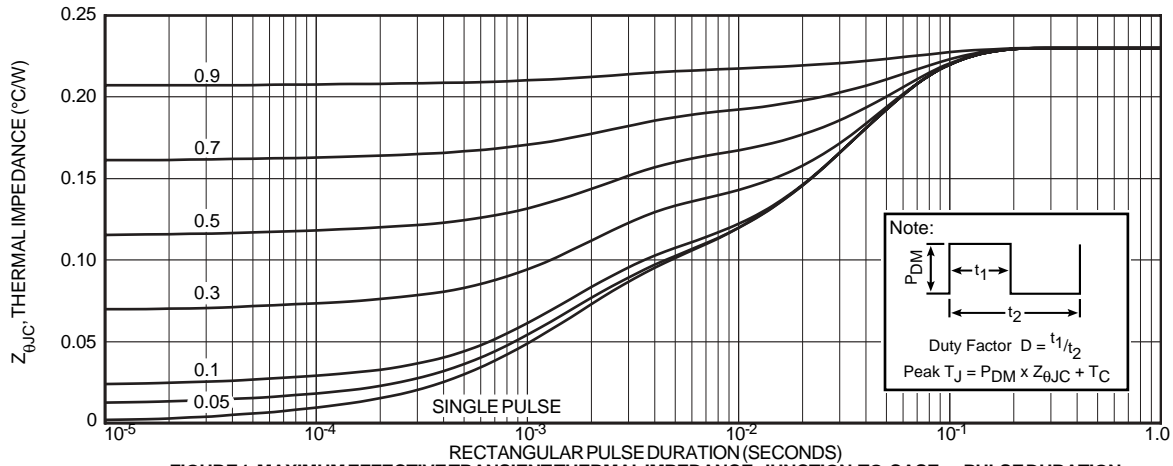

FIGURE 1, MAXIMUM EFFECTIVE TRANSIENT THERMAL IMPEDANCE, JUNCTION-TO-CASE vs PULSE DURATION

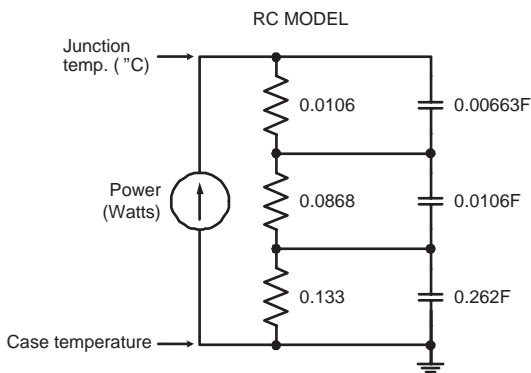

FIGURE 19B, TRANSIENT THERMAL IMPEDANCE MODEL

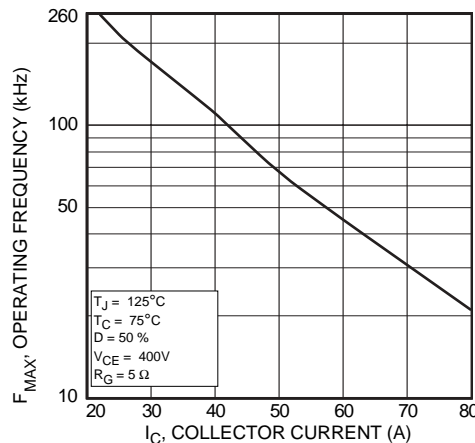

Figure 20, Operating Frequency vs Collector Current

$$F_{max} = \min(f_{max1}, f_{max2})$$

$$f_{max1} = \frac{0.05}{t_{d(on)} + t_r + t_{d(off)} + t_f}$$

$$f_{max2} = \frac{P_{diss} - P_{cond}}{E_{on2} + E_{off}}$$

$$P_{diss} = \frac{T_J - T_C}{R_{\theta JC}}$$

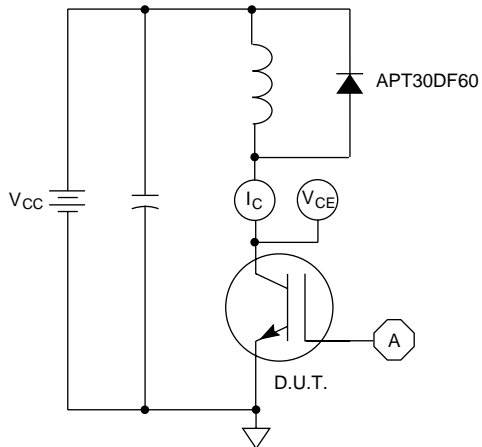

Figure 21, Inductive Switching Test Circuit

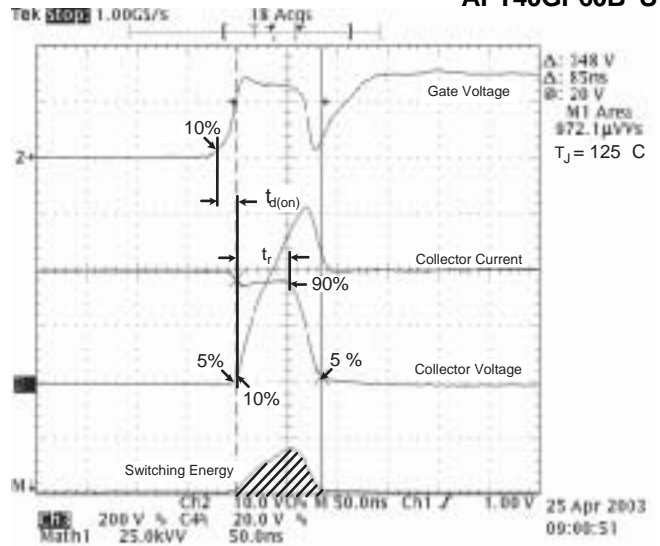

Figure 22, Turn-on Switching Waveforms and Definitions

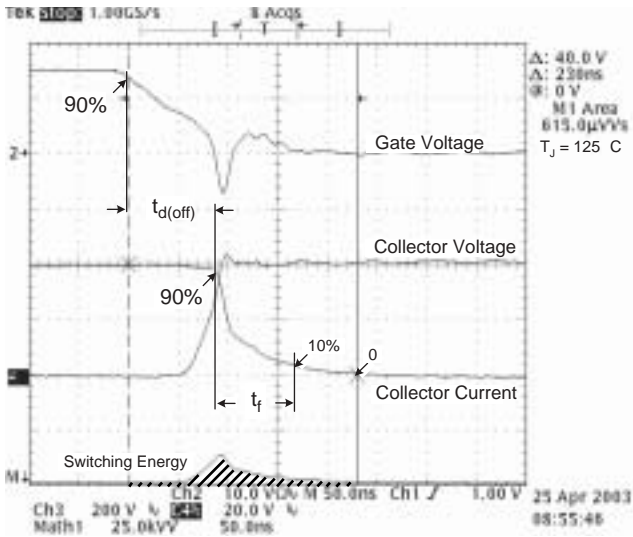

Figure 23, Turn-off Switching Waveforms and Definitions

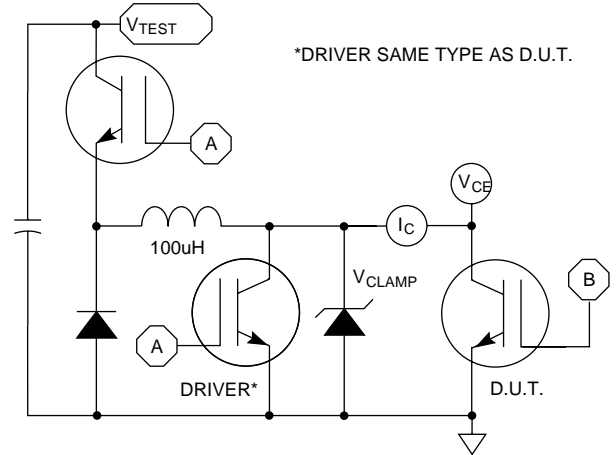
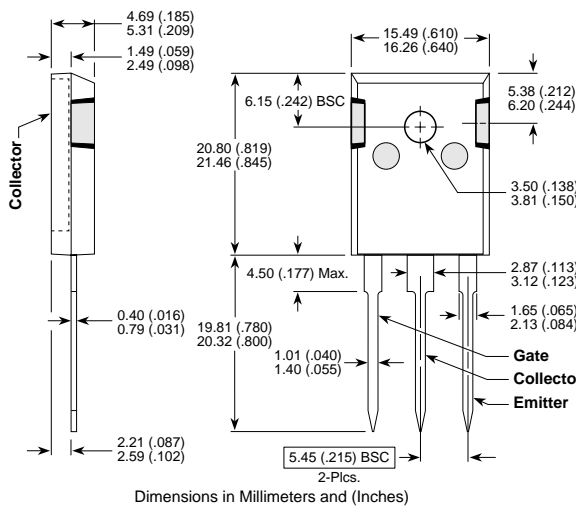
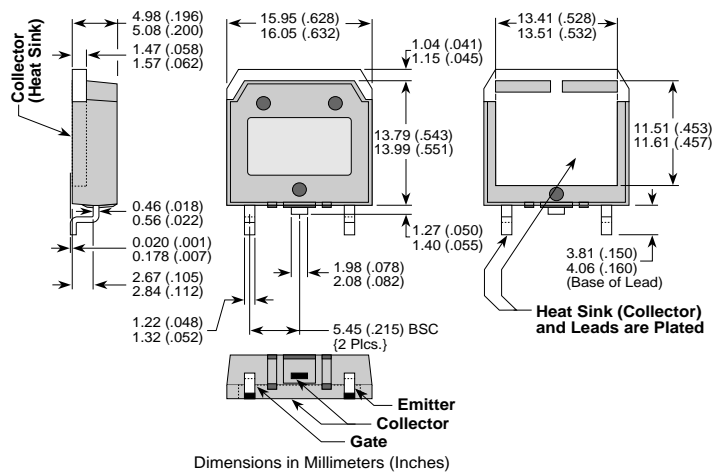

Figure 24, E_{ON1} Test Circuit

TO-247 Package Outline



D³PAK Package Outline



050-7403 Rev D 2-2004



Стандарт Электрон Связь

Мы молодая и активно развивающаяся компания в области поставок электронных компонентов. Мы поставляем электронные компоненты отечественного и импортного производства напрямую от производителей и с крупнейших складов мира.

Благодаря сотрудничеству с мировыми поставщиками мы осуществляем комплексные и плановые поставки широчайшего спектра электронных компонентов.

Собственная эффективная логистика и склад в обеспечивает надежную поставку продукции в точно указанные сроки по всей России.

Мы осуществляем техническую поддержку нашим клиентам и предпродажную проверку качества продукции. На все поставляемые продукты мы предоставляем гарантию .

Осуществляем поставки продукции под контролем ВП МО РФ на предприятия военно-промышленного комплекса России , а также работаем в рамках 275 ФЗ с открытием отдельных счетов в уполномоченном банке. Система менеджмента качества компании соответствует требованиям ГОСТ ISO 9001.

Минимальные сроки поставки, гибкие цены, неограниченный ассортимент и индивидуальный подход к клиентам являются основой для выстраивания долгосрочного и эффективного сотрудничества с предприятиями радиоэлектронной промышленности, предприятиями ВПК и научно-исследовательскими институтами России.

С нами вы становитесь еще успешнее!

Наши контакты:

Телефон: +7 812 627 14 35

Электронная почта: sales@st-electron.ru

Адрес: 198099, Санкт-Петербург,
Промышленная ул, дом № 19, литера Н,
помещение 100-Н Офис 331