

TS3002 1V/1 μ A Easy-to-Use Silicon Oscillator/Timer Demo Board

FEATURES

- FOUT Output frequency: 25kHz
 - $R_{SET} = 4.32M\Omega$, $C_{SET} = 7.9pF$
- PWMOUT Output Duty Cycle Range:
 - 12% to 90%
- Programmable Frequency Range:
 - $5.2kHz \leq F_{OUT} \leq 90kHz$ (BOOST = GND)
 - $5.2kHz \leq F_{OUT} \leq 290kHz$ (BOOST = VDD)
- Fully Assembled and Tested
- 2in x 2in 2-layer circuit board

COMPONENT LIST

DESIGNATION	QTY	DESCRIPTION
C1	1	0.1 μ F \pm 10% capacitor (0805)
C2	1	7.9pF \pm 10% capacitor (0805)
R1	1	1M Ω \pm 1% (0805)
R2	1	4.32M Ω \pm 1% (0805)
PWM_ADJ	1	1M Ω Potentiometer
U1	1	TS3002
VDD-GND, F_OUT, PWM_OUT	3	Test points
IBOOST, J1	2	Jumpers

DESCRIPTION

The demo board for the TS3002 is a completely assembled and tested circuit board that can be used for evaluating the TS3002. The TS3002 is the industry's first and only single-supply CMOS oscillator fully specified to operate at 1V while consuming a 1 μ A supply current at an output frequency of 25kHz. The TS3002 is Touchstone's first oscillator in the "NanoWatt Analog™" high-performance analog integrated circuits portfolio. The TS3002 can operate from a single-supply voltage from 0.9V to 1.8V.

The TS3002 requires only a resistor and a capacitor to set the output frequency. The demo board is available with an on-board 4.32M Ω R_{SET} resistor and 7.9pF C_{SET} capacitor that sets FOUT, at 25kHz. In addition, a PWMOUT output is made available where a voltage controlled pin is available to modulate the duty cycle of the signal from 12% to 90%. The TS3002 is fully specified over the -40°C to +85°C temperature range and is available in a low-profile, 8-pin 2x2mm TDFN package with an exposed back-side paddle.

Product datasheet and additional documentation can be found on factory web site at www.touchstonesemi.com.

ORDERING INFORMATION

Order Number	Description
TS3002DB	TS3002 Demo Board

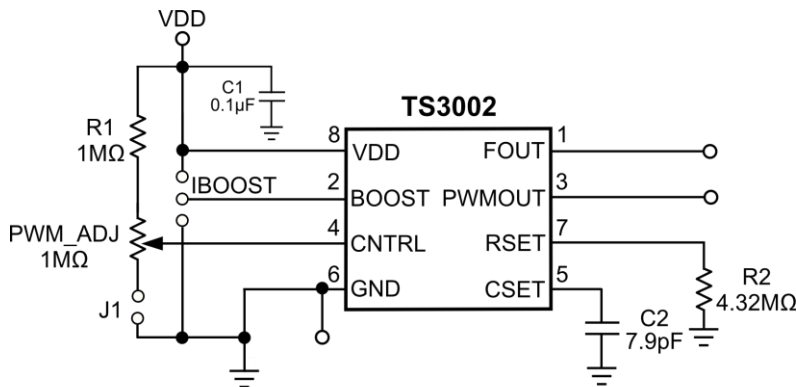

Figure 1. TS3002 Oscillator/Timer Circuit



Figure 2. TS3002 Evaluation Board



DESCRIPTION

The demo board includes an on-board 0.1μF decoupling capacitor at the V_{DD} pin. To modulate the duty cycle of the PWMOUT signal, adjust the potentiometer counter-clockwise to increase the duty cycle and vice versa. The PWMOUT is wired anti-phase with the FOUT output and can be disabled by removing jumper J1. Furthermore, when the BOOST pin is connected to VDD, the propagation delay of the internal comparators is reduced and in turn, extends the high end of the master oscillator frequency from 90kHz to 290kHz. The default setting for the BOOST pin is GND. An on-board jumper can be used to set the BOOST pin.

The TS3002 is a user-programmable oscillator where the period of the square wave at its FOUT terminal is generated by an external resistor and capacitor pair. The output frequency is given by:

$$F_{OUT} \text{ (kHz)} = \frac{1}{t_{FOUT} \text{ (}\mu\text{s)}} = \frac{1E6}{k \cdot R_{SET} \text{ (M}\Omega\text{)} \times C_{SET} \text{ (pF)}}$$

where the scalar k is approximately 1.19. As design aids, Tables 1 lists TS3002's typical FOUT for various standard values for R_{SET} with C_{SET} = 7.9pF and Table 2 lists typical FOUT for various standard values for C_{SET} with R_{SET} = 4.32MΩ. Furthermore, refer to page 4 and 5 for a series of plots of FOUT frequency and period vs R_{SET} and C_{SET}.

Table 1: FOUT vs R_{SET}, C_{SET} = 7.9pF

R _{SET} (MΩ)	FOUT (kHz)
1	106
2.49	43
4.32	25
6.81	16
9.76	11

Table 2: FOUT vs C_{SET}, R_{SET} = 4.32MΩ

C _{SET} (pF)	FOUT (kHz)
5	39
7.9	25
10	19
15	13
20	10

QUICK START PROCEDURE Required Equipment

- TS3002 Demo Board
- A DC Power Supply
- Oscilloscope Model Agilent DSO1014A or equivalent
- Two 10X, 15pF//10MΩ oscilloscope probes
- Potentiometer screwdriver

To evaluate the TS3002 silicon oscillator/timer, the following steps are to be performed:

- 1) Before connecting the DC power supply to the demo board, turn on the power supply, set the DC voltage to 1V, and then turn it off.
- 2) Connect the DC power supply positive terminal to the test point labeled VDD. Connect the negative terminal of the DC power supply to the test point labeled GND.
- 3) To monitor the FOUT output signal, connect the signal terminal of an oscilloscope probe to the test point labeled FOUT and the ground terminal to the test point labeled GND.
- 4) To monitor the PWMOUT output signal, connect the signal terminal of a second oscilloscope probe to the test point labeled PWMOUT and the ground terminal to the test point labeled GND.
- 5) To minimize transient power consumption of the probe capacitance of the oscilloscope, a series-connected capacitor can be added at either or both FOUT and PWMOUT terminals. To determine what the external series capacitor value should be, use the following expression:

$$C_{EXT} = \frac{1}{\frac{1}{C_{LOAD(EFF)}} - \frac{1}{C_{PROBE}}}$$

where C_{EXT} is the external series capacitor, C_{LOAD(EFF)} is the effective load capacitance, and C_{PROBE} is the capacitance of the oscilloscope probe.

- 6) Select two channels on the oscilloscope and set the vertical voltage scale and the vertical position on each channel to 200mV/DIV and 500mV, respectively. Set the horizontal time scale to 20 μ s/DIV. The coupling should be DC coupling.

Turn on the power supply. The supply current will vary depending on the load on the output, the BOOST pin setting, and whether the PWMOUT is enabled or disabled. Given the default set-up on the board with BOOST set to 0V, the PWMOUT duty cycle is set to ~49.3%. With an output load of 15pF on both FOUT and PWMOUT outputs due to the oscilloscope probes, the supply current should be less than 3 μ A. Refer to step 5 in order to minimize transient power consumption due to the probe capacitance, which can, in turn, reduce the supply current.

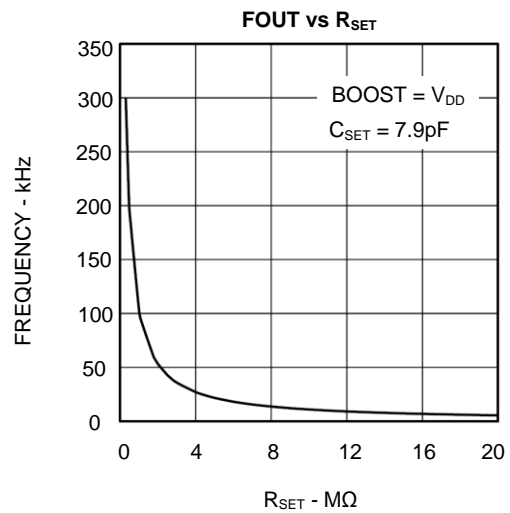
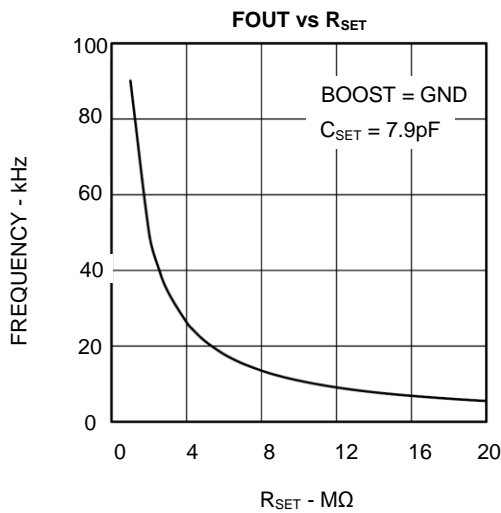
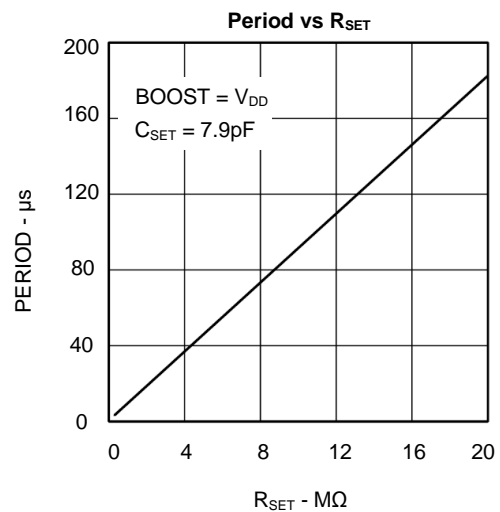
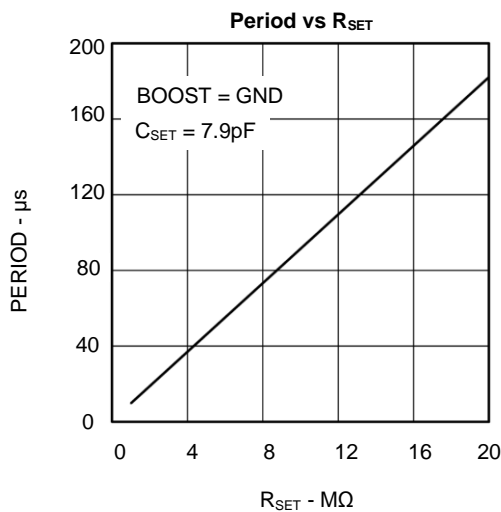

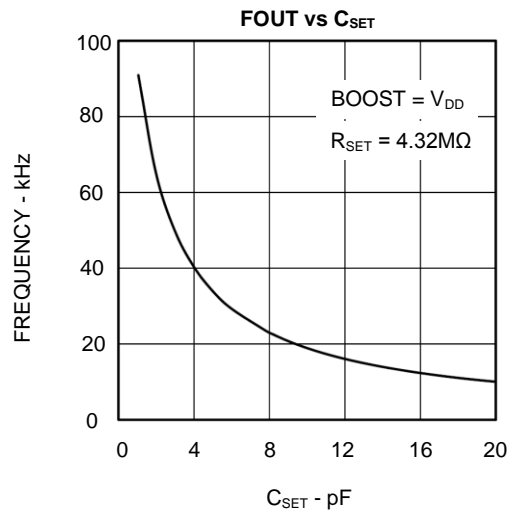
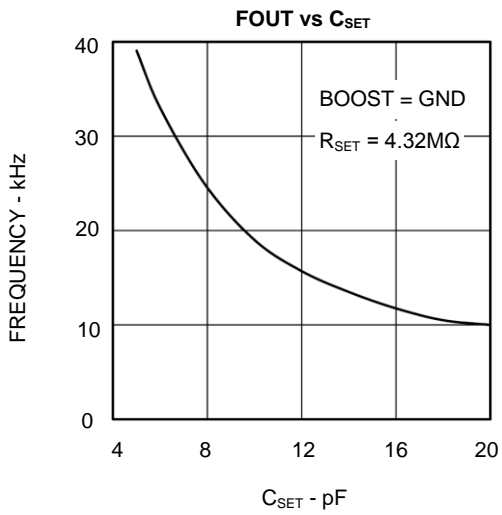
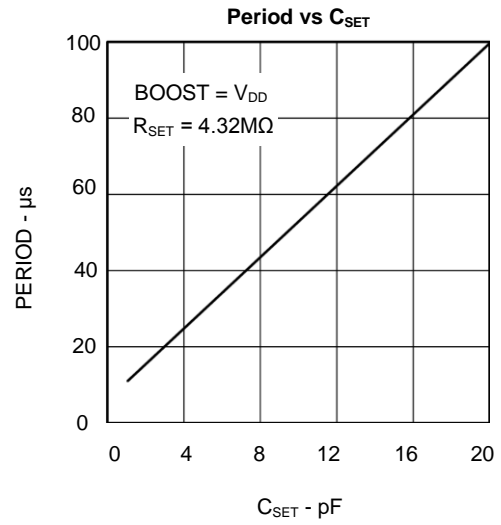
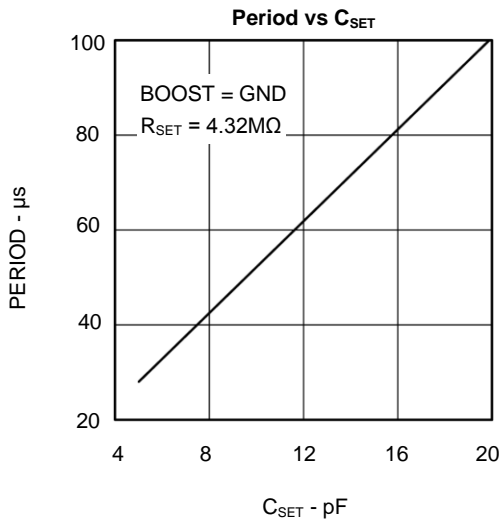

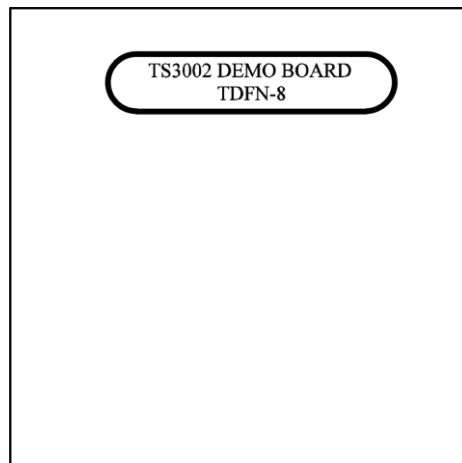
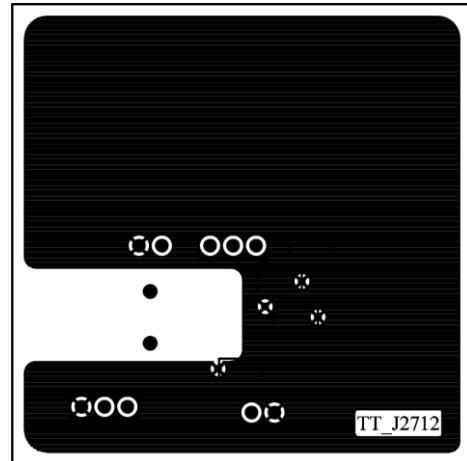
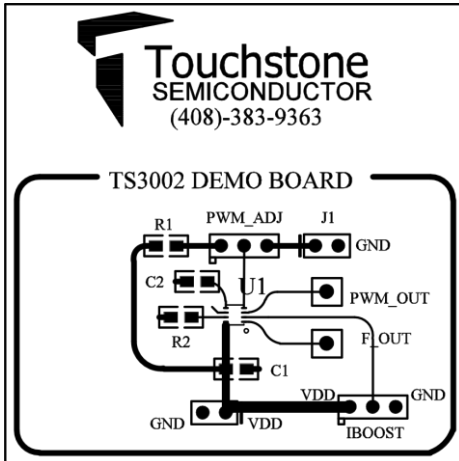



Стандарт Электрон Связь

Мы молодая и активно развивающаяся компания в области поставок электронных компонентов. Мы поставляем электронные компоненты отечественного и импортного производства напрямую от производителей и с крупнейших складов мира.

Благодаря сотрудничеству с мировыми поставщиками мы осуществляем комплексные и плановые поставки широчайшего спектра электронных компонентов.

Собственная эффективная логистика и склад в обеспечивает надежную поставку продукции в точно указанные сроки по всей России.

Мы осуществляем техническую поддержку нашим клиентам и предпродажную проверку качества продукции. На все поставляемые продукты мы предоставляем гарантию .

Осуществляем поставки продукции под контролем ВП МО РФ на предприятия военно-промышленного комплекса России , а также работаем в рамках 275 ФЗ с открытием отдельных счетов в уполномоченном банке. Система менеджмента качества компании соответствует требованиям ГОСТ ISO 9001.

Минимальные сроки поставки, гибкие цены, неограниченный ассортимент и индивидуальный подход к клиентам являются основой для выстраивания долгосрочного и эффективного сотрудничества с предприятиями радиоэлектронной промышленности, предприятиями ВПК и научно-исследовательскими институтами России.

С нами вы становитесь еще успешнее!

Наши контакты:

Телефон: +7 812 627 14 35

Электронная почта: sales@st-electron.ru

Адрес: 198099, Санкт-Петербург,
Промышленная ул, дом № 19, литера Н,
помещение 100-Н Офис 331