

Knob Operating Type Potentiometer With Knob Type

RK10J/RK14J Series



Low-profile, dip and reflow solderable.

Rotary
Potentiometers

Slide
Potentiometers

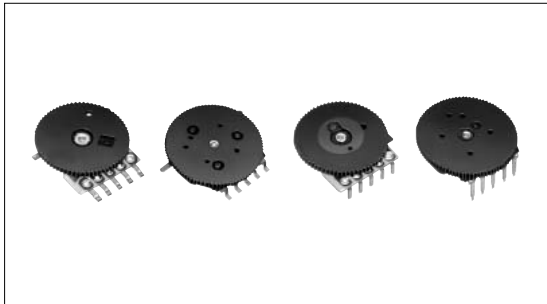

Typical Specifications

Items	Specifications	
	RK10J	RK14J
Total resistance tolerance	± 30%	
Maximum operating voltage	50V AC, 20V DC (Single-unit only)	
Total rotational angle	270 ± 10 °	270 ± 5 °
Operating life	10,000cycles	
Operating temperature range	- 10 to + 60	- 25 to + 70

Metal
Shaft

Insulated
Shaft

Knob
Operating

Product Line

Type	Number of resistor elements	Knob type	Total resistance (k)	Resistance taper	Soldering	Mounting board type	For DC use	Minimum order unit (pcs.)	Products No.	Drawing No.	
10mm Size	Single-unit	Outer size : 14 Knob thickness : t0.9 Color : Black	10	1B	Manual	Insertion (2mm)	20V DC	100	RK10J11E0034	1	
			20	3B					RK10J11E002Y		
	Dual-unit		10	15A			Not applicable		RK10J12E0A0A		
			20	15C					RK10J12E002L		
	10mm Size	Single-unit	Outer size : 14 Knob thickness : t1.0 Color : Black	10	15A	Reflow	Surface mounting	20V DC	1,000	RK10J11R001Y	2
					3B					RK10J11R0A0H	
		Dual-unit		Outer size : 14 Knob thickness : t2.5 Color : Black	15A			Not applicable		RK10J12R0A0B	
					15C					RK10J12R0052	
Dual-unit		Outer size : 14 Knob thickness : t2.5 Color : Black	20	15A	3	RK10J12R0A0Z					
			50	3B		RK10J12R0A02					
14mm Size	Single-unit	Outer size : 15 Knob thickness : t0.9 Color : Black	10	1B	Manual	Insertion (2mm)	20V DC	100	RK14J11A000G	4	
			50	3B					RK14J11A0A02		
			Dual-unit	100			1B		Not applicable		RK14J11A0007
				20			15C				RK14J12A0A0U
	Dual-unit		Outer size : 15 Knob thickness : t0.9 Color : Black	50	3B	RK14J12A0A0K					
				Single-unit	10	1B	Reflow	Surface mounting	20V DC	1,000	RK14J11R000J
	50		3B		RK14J11R000H						
	Dual-unit		Outer size : 15 Knob thickness : t0.9 Color : Black	10	15A	Not applicable	RK14J12R0A01				
		3B		RK14J12R0A0C							
	15C	RK14J12R0A09									

Notes

1. Products other than those listed in above products are also available. Please contact us for details.
2. Dip soldering can be applied to RK14J. For dip soldering applications, specify separately as "dip soldering applicable product."

Refer to P.396 for product varieties.

Dimensions

Unit:mm

No.	Photo	Style	PC board mounting hole dimensions (Viewed from mounting side)
1			
2			
3			
4			
5			

Product Varieties

In addition to the recommended products, the following specifications can also be accommodated.

Total Resistance Variety

Total resistance(k)	10	20	50	100
----------------------	----	----	----	-----

Resistance Taper

Resistance taper	15A	1B	3B	15C
------------------	-----	----	----	-----

PC board Mounting Hole Details

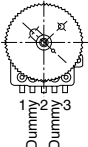
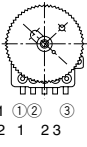
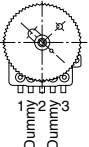
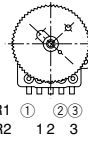
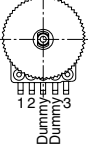
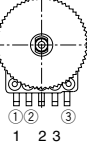
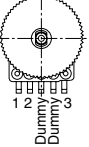
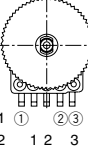
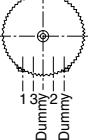
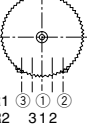
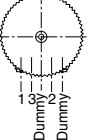
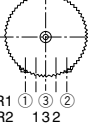
	Resistance taper A or B		Resistance taper C	
	Single-unit	Dual-unit	Single-unit	Dual-unit
10mm Single-unit · Dual-unit RK10J1 E				
10mm Single-unit · Dual-unit RK10J1 R (Reflow-type)				
14mm Single-unit · Dual-unit RK14J1 A RK14J1 R				

Knob Variety

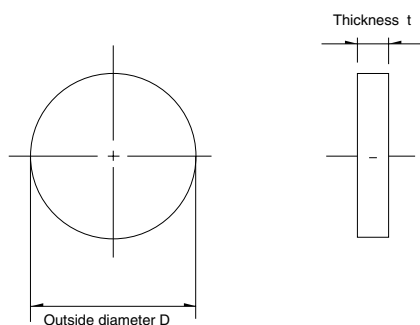

Applicable models	Knob variety				Body thickness (mm)
	Type	Outer Diameter D	Knob thickness (mm)	Color	
RK10J11E RK10J12E	K4	14	0.9	Black Gray Ivory White	1.8
	K5	16	3.0		4.0
RK10J11R RK10J12R (Reflow-type)	K1	14	1.0	Black	2.5
	K2	14	2.5		3.8
	K3	16			3.8
RK14J11A RK14J12A	K1	15	0.9	Black Gray Ivory White	2.5
	K2	15	3.0		4.6
	K3	18			4.6
RK14J11R RK14J12R (Reflow-type)	K1	15	0.9	Black	2.0
	K2	15	3.0		4.1

Mounting Plate Types and Terminal Types

Unit:mm

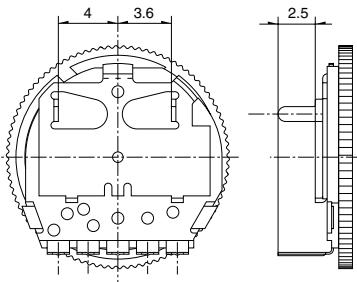
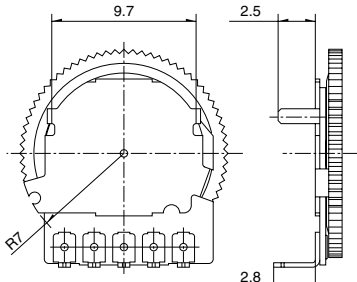
RK14J1 A 	RK10J1 E 
--	---

Note

marked are specifications recommended by ALPS.

Refer to P.397, 502 for resistance taper.

Orders Other Than Recommended Products

When ordering product varieties that are not listed in the Product Line, please specify by referring to the below example.

Sample Part Number

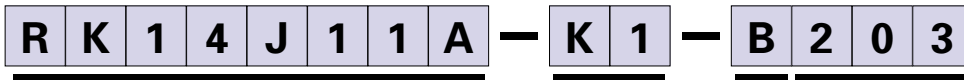

Model type

Code	Model type
RK10J11E	10mm size single-unit print terminal
RK10J12E	10mm size dual-unit print terminal
RK10J11R	10mm size single-unit Reflow type
RK10J12R	10mm size dual-unit Reflow type
RK14J11A	14mm size single-unit print terminal
RK14J12A	14mm size dual-unit print terminal
RK14J11R	14mm size single-unit Reflow type
RK14J12R	14mm size dual-unit Reflow type

Shaft type (Outer diameter·Thickness)

Code	RK10J1 E	RK10J1 R	RK14J1 A	RK14J1 R
K1	—	φ 14 t1.0	φ 15 t0.9	φ 15 t0.9
K2	—	φ 14 t2.5	φ 15 t3.0	φ 15 t3.0
K3	—	φ 16 t2.5	φ 18 t3.0	—
K4	φ 14 t0.9	—	—	—
K5	φ 16 t3.0	—	—	—

* Color : Black

Resistance taper

Code	Resistance taper	Code	Resistance taper
A	15A	C	15C
B	1B	V	3B

B: For tone & general
V: For vol.

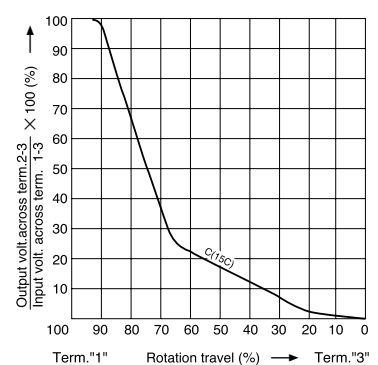
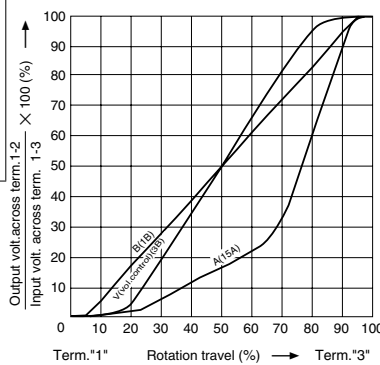

Total resistance

Code	Total resistance (kΩ)	Code	Total resistance (kΩ)
103	10	503	50
203	20	104	100

Circuit Diagram

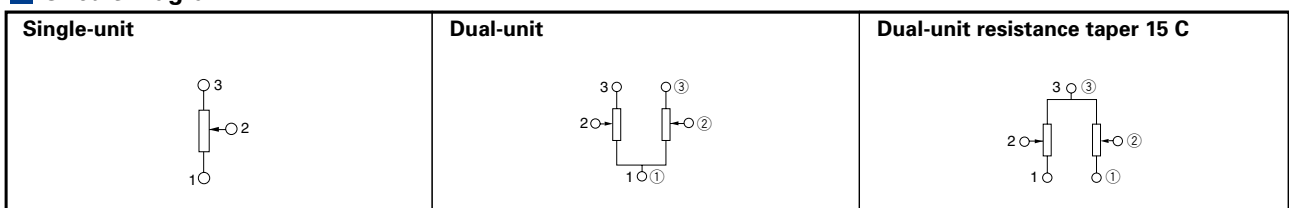

Note

marked are specifications recommended by ALPS.

Rotary Potentiometers
Slide Potentiometers

Metal Shaft
Insulated Shaft
Knob Operating

List of Varieties

Items		Type	Without knob		With knob			
		Model	RK08H1 1 RK08H1 2	RK08H1 3	RK10J1 E	RK10J1 R	RK14J1 A	RK14J1 R
			Vertical back-to-back mounting	Reflow type	Insertion type	Reflow type	Insertion type	Reflow type
Photo								
Electrical performance	Rated power	0.03W						
	Insulation resistance	100M min. 100V DC						
	Voltage proof	100V AC (for 1minute)						
Mechanical performance	Strength of the operating section	Stopper strength	0.1N·m		70mN·m			
		Push-pull strength (In vertical direction against the P.W.B. surface)	10N max.		5N max.			
	Vibration		10 to 55 to 10Hz/min., the amplitude is 1.5mm for all the frequencies, in the 3 direction of X, Y and Z and for 2 hours respectively					
	Solder heat resistance	Manual soldering	350 max. 3s max.					
		Dip soldering	—				260 ± 5 4 ± 1s	—
	Reflow soldering	—	Please see P.398	—	Please see P.398	—	Please see P.398	
Environmental performance	Cold	- 10 ± 2 for 96h				- 25 ± 2 for 240h		
	Dry heat	70 ± 2 for 96h				70 ± 2 for 240h		
	Damp heat	40 ± 2 , 90 to 95%RH for 96h						
Page		390			394			

Rotary Potentiometers
Slide Potentiometers

Metal Shaft

Insulated Shaft

Knob Operating

Maximum Attenuation or Residual Resistance

Application of non-standard

Nominal total resistance	Maximum attenuation	Nominal total resistance	Residual resistance
R 100k	90dB min.	100k R 50k	0.1% or less of nominal total resistance
100k > R 50k	80dB min.	50k > R > 10k	30 or less
50k > R 10k	70dB min.	10k R	20 or less
10k > R	60dB min.		

Knob Operating Type Potentiometers Cautions399

Knob Operating Type Potentiometers Soldering Conditions398

Note

Contact us separately when you require reflow type taping specifications.

Soldering Conditions

Soldering Conditions

1. Recommended reflow conditions

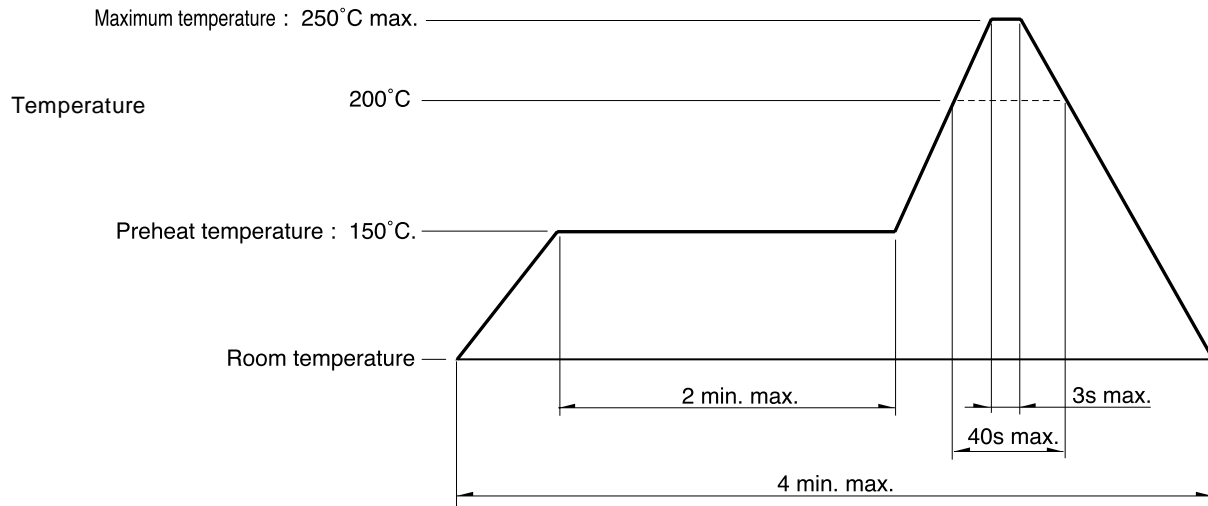

- | | |
|------------------------------|--|
| 2. Cleaning | Cleaning should not be attempted. |
| 3. Type of solder to be used | Use cream solder that contains 10 - 15 %wt flux. |
| 4. Soldering | Mounting plate should also be soldered. |

Notes

- When using an infrared reflow oven, solder may sometimes not be applied. Be sure to use a hot air reflow oven or a type that uses infrared rays in combination with hot air.
- The temperatures given above are the maximum temperatures at the terminals of the potentiometer when employing a hot air reflow method. The temperature of the PC board and the surface temperature of the potentiometer may vary greatly depending on the PC board material, its size and thickness. Ensure that the surface temperature of the potentiometer does not rise to 250°C or greater.
- Conditions vary to some extent depending on the type of reflow bath used. Be sure to give due consideration to this prior to use.

Rotary Potentiometers
Slide Potentiometers

Metal Shaft

Insulated Shaft

Knob Operating



Стандарт Электрон Связь

Мы молодая и активно развивающаяся компания в области поставок электронных компонентов. Мы поставляем электронные компоненты отечественного и импортного производства напрямую от производителей и с крупнейших складов мира.

Благодаря сотрудничеству с мировыми поставщиками мы осуществляем комплексные и плановые поставки широчайшего спектра электронных компонентов.

Собственная эффективная логистика и склад в обеспечивает надежную поставку продукции в точно указанные сроки по всей России.

Мы осуществляем техническую поддержку нашим клиентам и предпродажную проверку качества продукции. На все поставляемые продукты мы предоставляем гарантию .

Осуществляем поставки продукции под контролем ВП МО РФ на предприятия военно-промышленного комплекса России , а также работаем в рамках 275 ФЗ с открытием отдельных счетов в уполномоченном банке. Система менеджмента качества компании соответствует требованиям ГОСТ ISO 9001.

Минимальные сроки поставки, гибкие цены, неограниченный ассортимент и индивидуальный подход к клиентам являются основой для выстраивания долгосрочного и эффективного сотрудничества с предприятиями радиоэлектронной промышленности, предприятиями ВПК и научно-исследовательскими институтами России.

С нами вы становитесь еще успешнее!

Наши контакты:

Телефон: +7 812 627 14 35

Электронная почта: sales@st-electron.ru

Адрес: 198099, Санкт-Петербург,
Промышленная ул, дом № 19, литера Н,
помещение 100-Н Офис 331