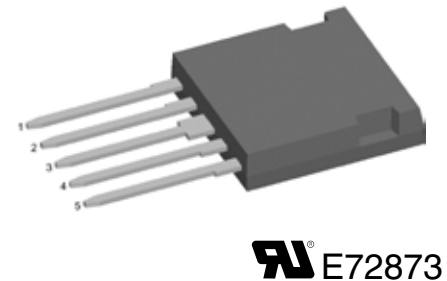
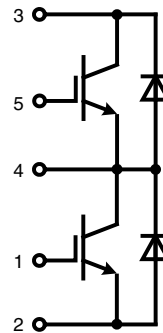

# IGBT phaseleg

in ISOPLUS i4-PAC™

 $I_{C25} = 30 \text{ A}$   
 $V_{CES} = 600 \text{ V}$   
 $V_{CE(sat) \text{ typ.}} = 1.9 \text{ V}$ 

IGBT			
Symbol	Conditions	Maximum Ratings	
$V_{CES}$	$T_{VJ} = 25^\circ\text{C to } 150^\circ\text{C}$	600	V
$V_{GES}$		$\pm 20$	V
$I_{C25}$	$T_C = 25^\circ\text{C}$	30	A
$I_{C90}$	$T_C = 90^\circ\text{C}$	18	A
$I_{CM}$	$V_{GE} = \pm 15 \text{ V}; R_G = 47 \Omega; T_{VJ} = 125^\circ\text{C}$	40	A
$V_{CEK}$	<b>RBSOA</b> Clamped inductive load; $L = 100 \mu\text{H}$	$V_{CES}$	
$t_{SC}$ (SCSOA)	$V_{CE} = V_{CES}; V_{GE} = \pm 15 \text{ V}; R_G = 47 \Omega$ $T_{VJ} = 125^\circ\text{C}; \text{non-repetitive}$	10	$\mu\text{s}$
$P_{tot}$	$T_C = 25^\circ\text{C}$	100	W

### Features

- NPT IGBT technology
  - low saturation voltage
  - positive temperature coefficient for easy paralleling
  - fast switching
- HiPerFRED™ diode
  - optimized fast and soft reverse recovery
  - low operating forward voltage
  - low leakage current
- ISOPLUS i4-PAC™ package
  - isolated back surface
  - low coupling capacity between pins and heatsink
  - enlarged creepage towards heatsink
  - application friendly pinout
  - low inductive current path
  - high reliability
  - industry standard outline
  - UL registered E 72873

Symbol	Conditions	Characteristic Values				
		$(T_{VJ} = 25^\circ\text{C}, \text{ unless otherwise specified})$				
		min.	typ.	max.		
$V_{CE(sat)}$	$I_C = 20 \text{ A}; V_{GE} = 15 \text{ V}$	$T_{VJ} = 25^\circ\text{C}$		1.9	2.4	V
		$T_{VJ} = 125^\circ\text{C}$		2.2		V
$V_{GE(th)}$	$I_C = 0.5 \text{ mA}; V_{GE} = V_{CE}$	4.5		6.5	V	
$I_{CES}$	$V_{CE} = V_{CES}; V_{GE} = 0 \text{ V}$		0.6	0.6	mA mA	
$I_{GES}$	$V_{CE} = 0 \text{ V}; V_{GE} = \pm 20 \text{ V}$			200	nA	
$t_{d(on)}$ $t_r$ $t_{d(off)}$ $t_f$ $E_{on}$ $E_{off}$	Inductive load $V_{CE} = 300 \text{ V}; I_C = 20 \text{ A}$ $V_{GE} = \pm 15 \text{ V}; R_G = 47 \Omega$	$T_{VJ} = 125^\circ\text{C}$		50		ns
				55		ns
				200		ns
				30		ns
				0.75		mJ
				0.6		mJ
$C_{ies}$	$V_{CE} = 25 \text{ V}; V_{GE} = 0 \text{ V}; f = 1 \text{ MHz}$		1.1			nF
$Q_{Gon}$	$V_{CE} = 300 \text{ V}; V_{GE} = 15 \text{ V}; I_C = 20 \text{ A}$		65			nC
$R_{thJC}$				1.25		K/W
$R_{thJH}$	with heatsink compound		2.5			K/W

### Applications

- single phaseleg
  - buck-boost chopper
- H bridge
  - power supplies
  - induction heating
  - four quadrant DC drives
  - controlled rectifier
- three phase bridge
  - AC drives
  - controlled rectifier

Diode						
Symbol	Conditions		Maximum Ratings			
$V_{RRM}$	$T_{VJ} = 25^{\circ}\text{C}$ to $150^{\circ}\text{C}$		600	V		
$I_{F25}$	$T_C = 25^{\circ}\text{C}$		30	A		
$I_{F90}$	$T_C = 90^{\circ}\text{C}$		15	A		
Symbol	Conditions		Characteristic Values			
			min.	typ.	max.	
$V_F$	$I_F = 20\text{ A}$	$T_{VJ} = 25^{\circ}\text{C}$		2.3	2.7	V
		$T_{VJ} = 125^{\circ}\text{C}$		1.6		V
$I_{RM}$ $t_{rr}$	} $I_F = 15\text{ A}; di_F/dt = -400\text{ A}/\mu\text{s};$ $V_R = 300\text{ V}; V_{GE} = 0\text{ V};$	$T_{VJ} = 125^{\circ}\text{C}$		7		A
				50		ns
$R_{thJC}$	(per diode)				2.3	K/W
$R_{thJH}$	with heatsink compound			4.6		K/W

Component						
Symbol	Conditions		Maximum Ratings			
$T_{VJ}$	operating		-55...+150	°C		
$T_{stg}$			-55...+125	°C		
$V_{ISOL}$	$I_{ISOL} \leq 1\text{ mA}; 50/60\text{ Hz}; t = 1\text{ s}$		2500	V~		
$F_C$	Mounting force with clip		20...120	Nm		
Symbol	Conditions		Characteristic Values			
			min.	typ.	max.	
$C_P$	coupling capacity between shorted pins and mounting tab in the case			40		pF
$d_{s, d_A}$	pin - pin		1.7			mm
$d_{s, d_A}$	pin - backside metal		5.5			mm
<b>Weight</b>				6		g

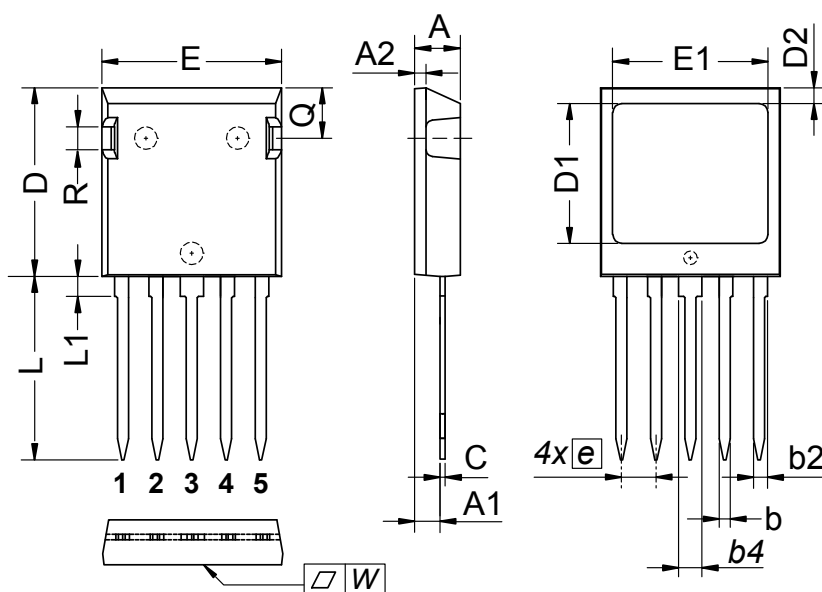

DIM.	MILLIMETER		INCHES	
	MIN	MAX	MIN	MAX
A	4.83	5.21	0.190	0.205
A1	2.59	3.00	0.102	0.118
A2	1.17	2.16	0.046	0.085
b	1.14	1.40	0.045	0.055
b2	1.47	1.73	0.058	0.068
b4	2.54	2.79	0.100	0.110
C	0.51	0.74	0.020	0.029
D	20.80	21.34	0.819	0.840
D1	14.99	15.75	0.590	0.620
D2	1.65	2.03	0.065	0.080
E	19.56	20.29	0.770	0.799
E1	16.76	17.53	0.660	0.690
e	3.81 BSC		0.15 BSC	
L	19.81	21.34	0.780	0.840
L1	2.11	2.59	0.083	0.102
Q	5.33	6.20	0.210	0.244
R	2.54	4.57	0.100	0.180
W	—	0.10	—	0.004

Die konvexe Form des Substrates ist typ. < 0.05 mm über der Kunststoffoberfläche der Bauteilunterseite  
 The convex bow of substrate is typ. < 0.05 mm over plastic surface level of device bottom side

### Typ. output characteristics

$$I_C = f(V_{CE})$$

parameter:  $t_p = 250 \mu s$ ;  $T_j = 25^\circ C$

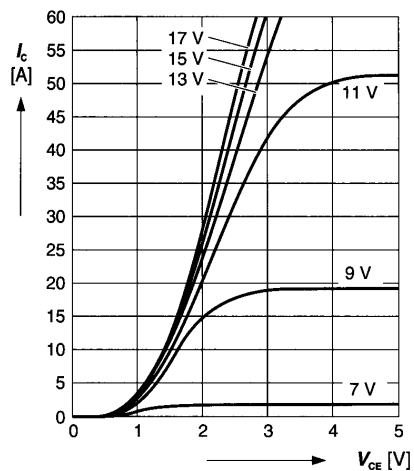

### Typ. output characteristics

$$I_C = f(V_{CE})$$

parameter:  $t_p = 250 \mu s$ ;  $T_j = 125^\circ C$

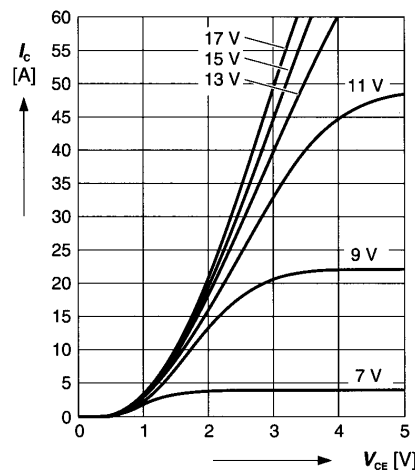

### Typ. gate charge

$$V_{GE} = f(Q_g)$$

parameter:  $I_{C\ pulis} = 20\ A$

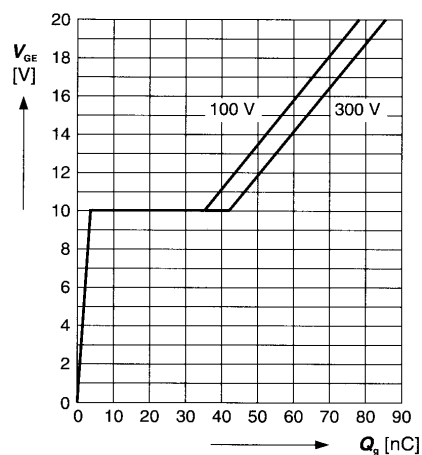

### Typ. capacitances

$$C = f(V_{CE})$$

parameter:  $V_{GE} = 0\ V$ ;  $f = 1\ MHz$

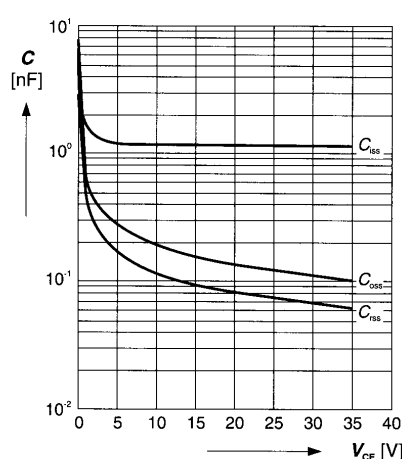

### Reverse biased safe operating area

$$I_{C\ pulis} = f(V_{CE}), T_j = 150^\circ C$$

parameter:  $V_{GE} = 15\ V$

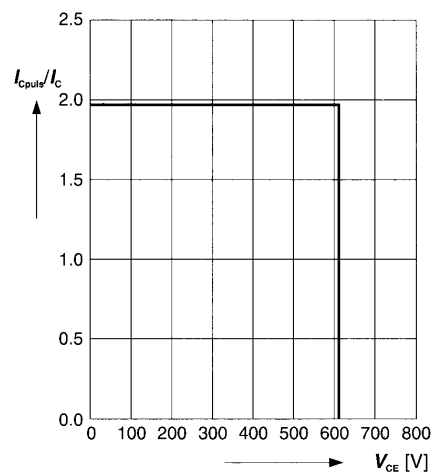

### Short circuit safe operating area

$$I_{C\ sc} = f(V_{CE}), T_j = 150^\circ C$$

parameter:  $V_{GE} = \pm 15\ V$ ;  $t_{sc} \le 10\ \mu s$ ;  $L < 50\ nH$

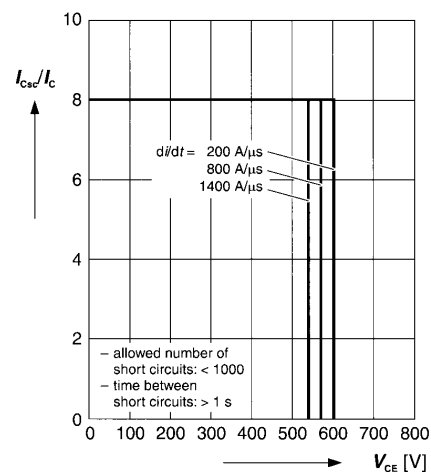

### Typ. switching time

$t = f(I_C)$ , inductive load,  $T_J = 125\text{ }^\circ\text{C}$   
 parameter:  $V_{CE} = 300\text{ V}$ ;  $V_{GE} = \pm 15\text{ V}$ ;  $R_G = 33\text{ }\Omega$

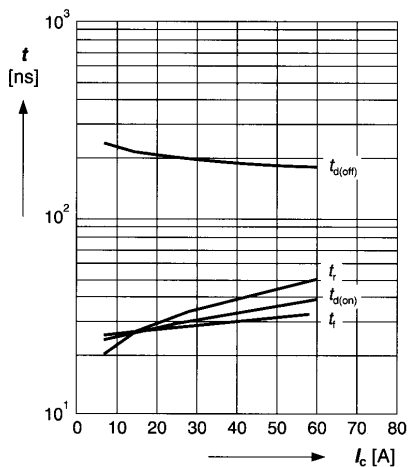

### Typ. switching time

$t = f(R_G)$ , inductive load,  $T_J = 125\text{ }^\circ\text{C}$   
 parameter:  $V_{CE} = 300\text{ V}$ ;  $V_{GE} = \pm 15\text{ V}$ ;  $I_C = 30\text{ A}$

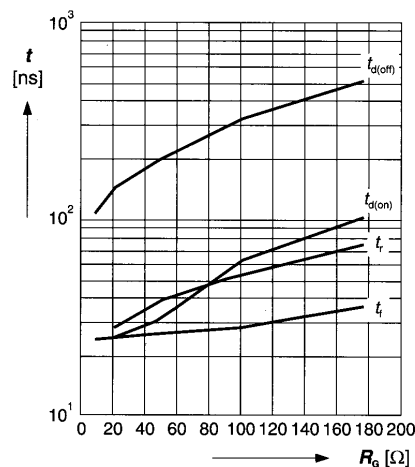

### Typ. switching losses

$E = f(I_C)$ , inductive load,  $T_J = 125\text{ }^\circ\text{C}$   
 parameter:  $V_{CE} = 300\text{ V}$ ;  $V_{GE} = \pm 15\text{ V}$ ;  $R_G = 33\text{ }\Omega$

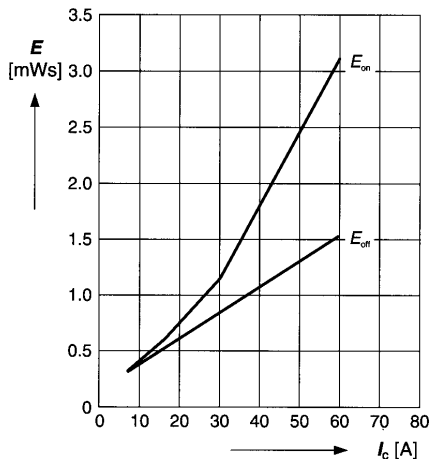

### Typ. switching losses

$E = f(R_G)$ , inductive load,  $T_J = 125\text{ }^\circ\text{C}$   
 parameter:  $V_{CE} = 300\text{ V}$ ;  $V_{GE} = \pm 15\text{ V}$ ;  $I_C = 30\text{ A}$

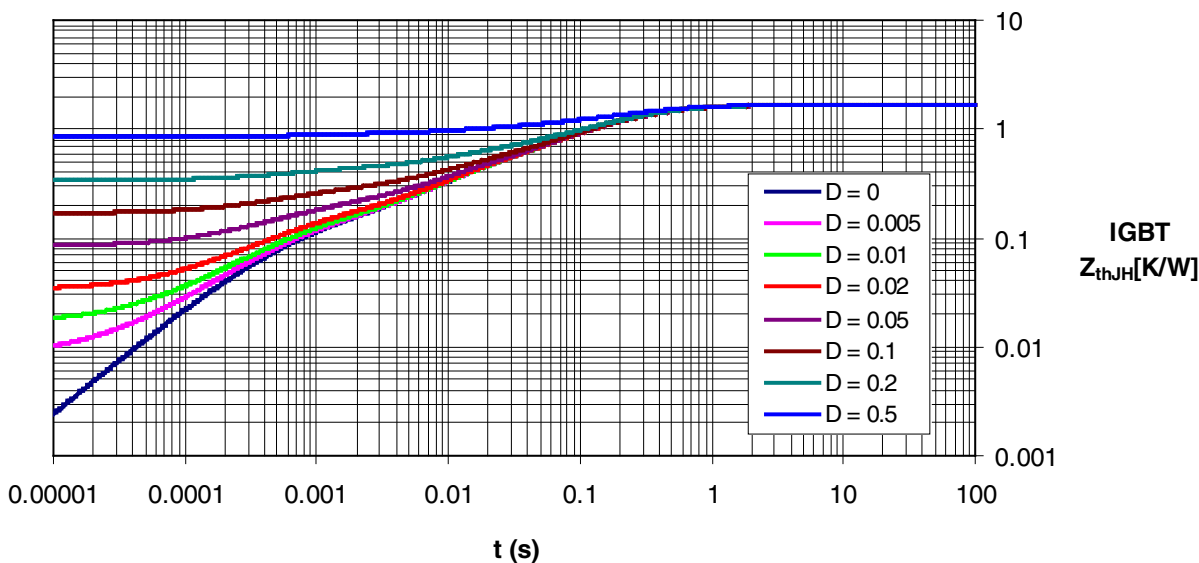
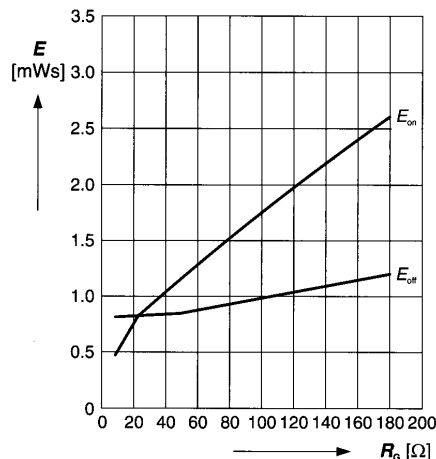

IGBT  
 $Z_{thJH}[\text{K/W}]$

## Diode

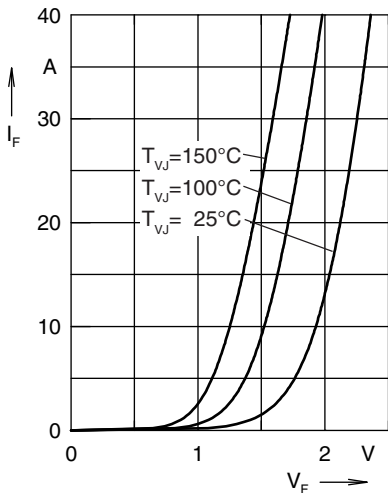

Forward current  $I_F$  versus  $V_F$

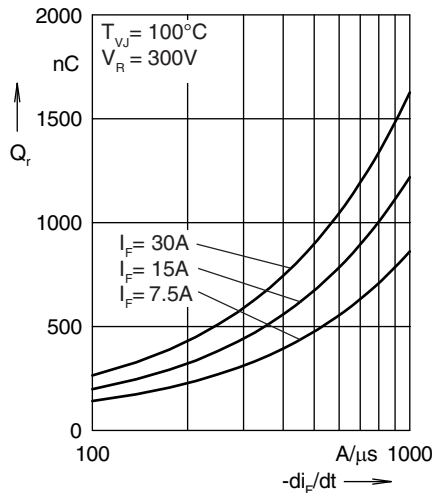

Reverse recovery charge  $Q_r$  versus  $-di_F/dt$

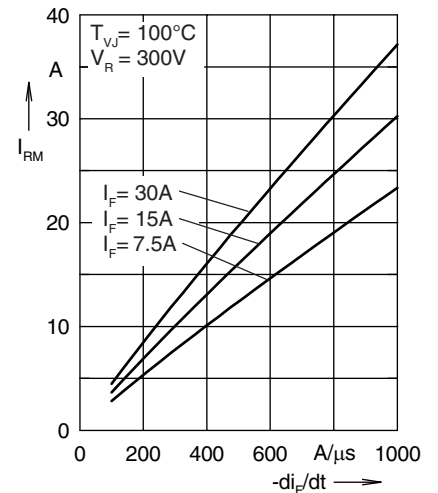

Peak reverse current  $I_{RM}$  versus  $-di_F/dt$

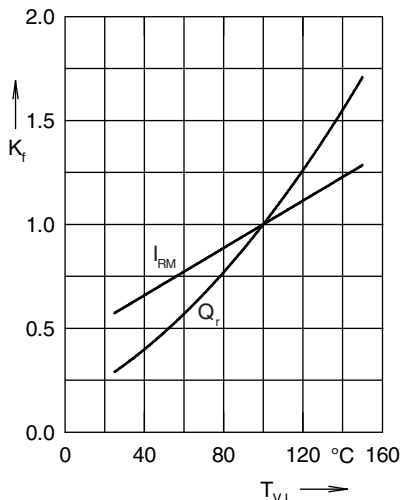

Dynamic parameters  $Q_r$ ,  $I_{RM}$  versus  $T_{VJ}$

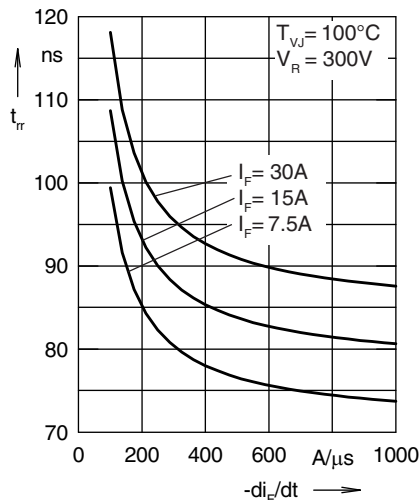

Recovery time  $t_{tr}$  versus  $-di_F/dt$

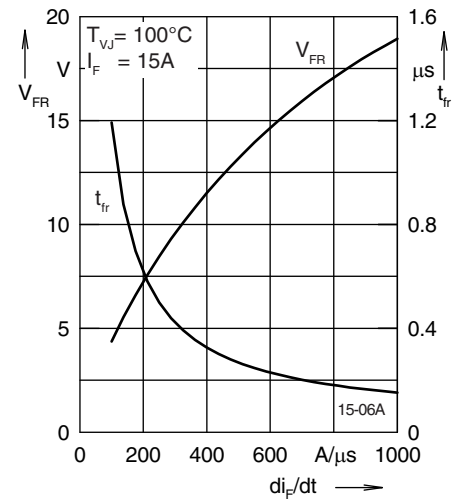

Peak forward voltage  $V_{FR}$  and  $t_{tr}$  versus  $di_F/dt$

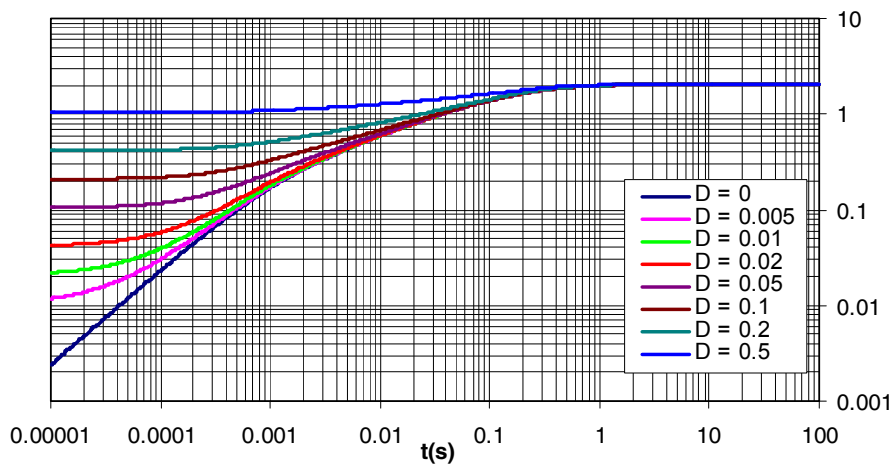

Transient thermal resistance junction to heatsink



## Стандарт Электрон Связь

Мы молодая и активно развивающаяся компания в области поставок электронных компонентов. Мы поставляем электронные компоненты отечественного и импортного производства напрямую от производителей и с крупнейших складов мира.

Благодаря сотрудничеству с мировыми поставщиками мы осуществляем комплексные и плановые поставки широчайшего спектра электронных компонентов.

Собственная эффективная логистика и склад в обеспечивает надежную поставку продукции в точно указанные сроки по всей России.

Мы осуществляем техническую поддержку нашим клиентам и предпродажную проверку качества продукции. На все поставляемые продукты мы предоставляем гарантию .

Осуществляем поставки продукции под контролем ВП МО РФ на предприятия военно-промышленного комплекса России , а также работаем в рамках 275 ФЗ с открытием отдельных счетов в уполномоченном банке. Система менеджмента качества компании соответствует требованиям ГОСТ ISO 9001.

Минимальные сроки поставки, гибкие цены, неограниченный ассортимент и индивидуальный подход к клиентам являются основой для выстраивания долгосрочного и эффективного сотрудничества с предприятиями радиоэлектронной промышленности, предприятиями ВПК и научно-исследовательскими институтами России.

С нами вы становитесь еще успешнее!

### Наши контакты:

**Телефон:** +7 812 627 14 35

**Электронная почта:** [sales@st-electron.ru](mailto:sales@st-electron.ru)

**Адрес:** 198099, Санкт-Петербург,  
Промышленная ул, дом № 19, литера Н,  
помещение 100-Н Офис 331