

G2-LAURA-W-P

~45° wide beam. Assembly with thinner white holder, installation tape and location pins.

TECHNICAL SPECIFICATIONS:

Dimensions	21.6 mm
Height	13.1 mm
Fastening	tape, pin
ROHS compliant	yes ⓘ

MATERIAL SPECIFICATIONS:

Component	Type	Material	Colour	Finish
LAURA-W	Single lens	PMMA	clear	
LAURA-LT-PIN-XP-HLD-WHT	Holder	PC	white	
ROSE-TAPE	Tape	PU tape	black	



ORDERING INFORMATION:

Component		Qty in box	MOQ	MPQ	Box weight (kg)
CA13634_G2-LAURA-W-P	Single lens	1440	360	180	6.1
» Box size: 450 x 260 x 160 mm					

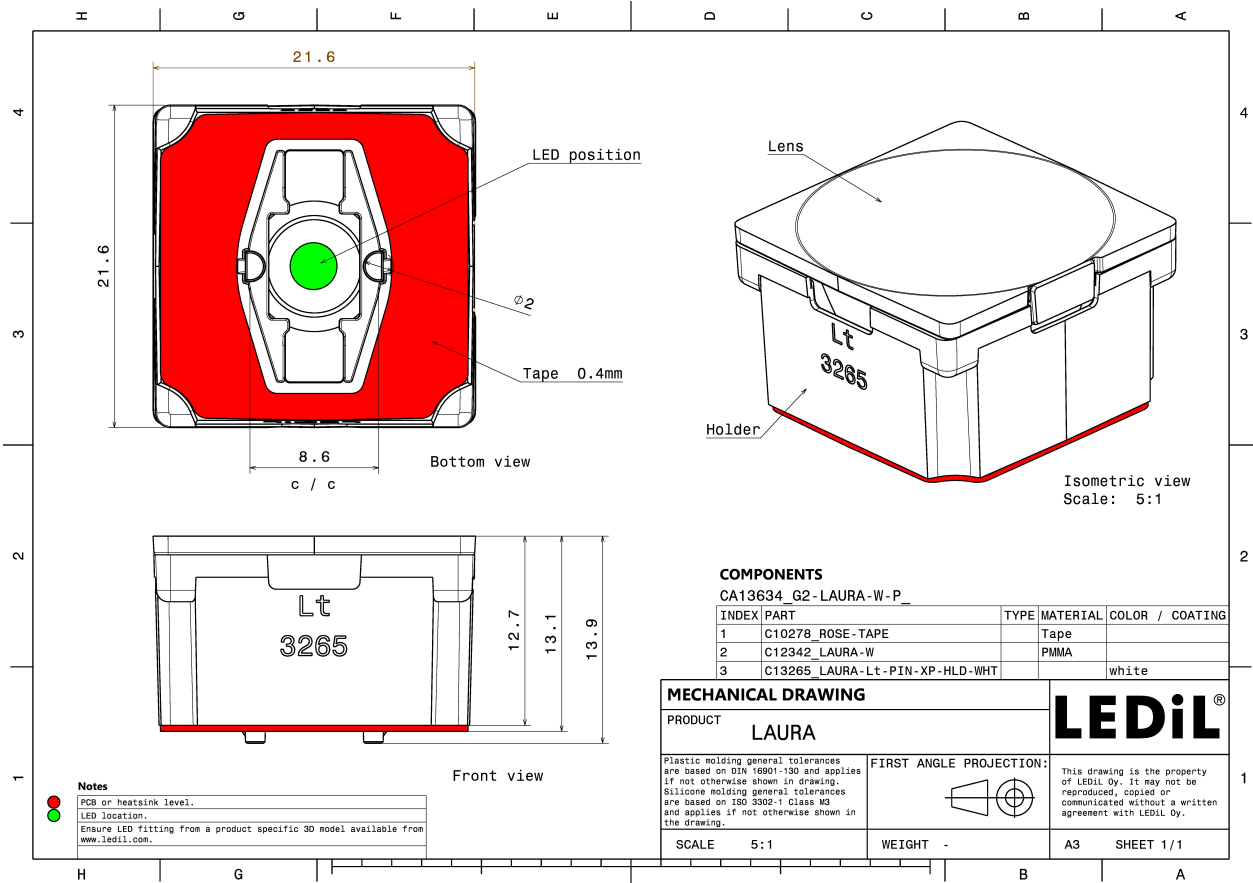

PHOTOMETRIC DATA (MEASURED):

CREE

LED XB-D
 FWHM 40.0°
 Efficiency 84 %
 Peak intensity 1.6 cd/lm
 LEDs/each optic 1
 Light colour White
 Required components:

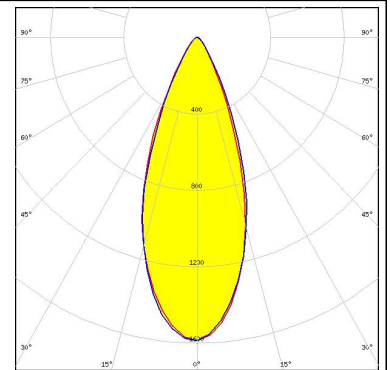
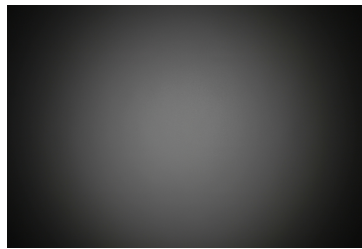

CREE

LED XB-H
 FWHM 47.0°
 Efficiency 86 %
 Peak intensity 1.3 cd/lm
 LEDs/each optic 1
 Light colour White
 Required components:

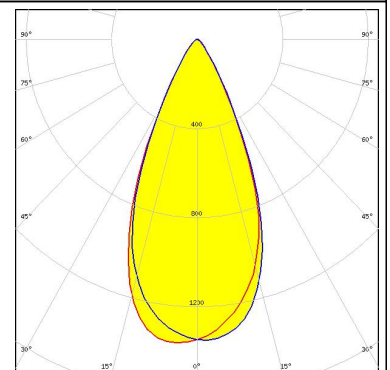
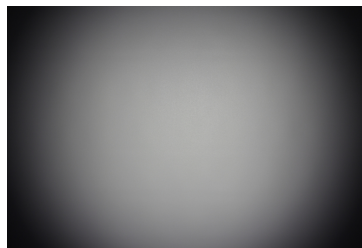

CREE

LED XP-E
 FWHM 45.0°
 Efficiency 86 %
 Peak intensity 1.5 cd/lm
 LEDs/each optic 1
 Light colour White
 Required components:

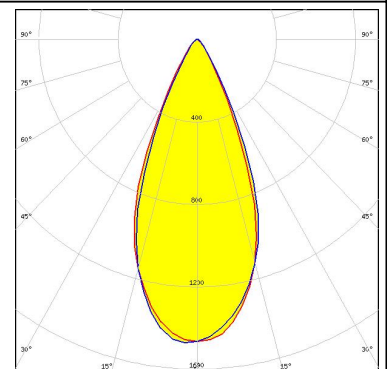
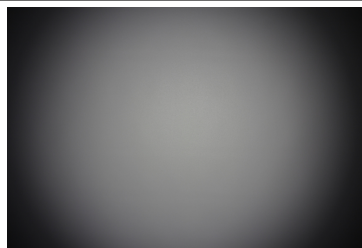

CREE

LED XP-E2
 FWHM 45.0°
 Efficiency 87 %
 Peak intensity 1.5 cd/lm
 LEDs/each optic 1
 Light colour White
 Required components:

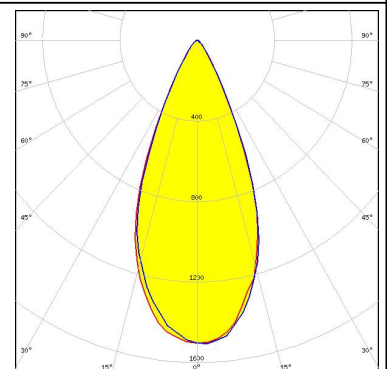
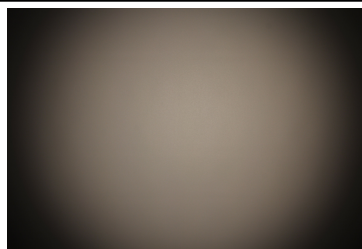

PHOTOMETRIC DATA (MEASURED):

CREE

LED XP-G
 FWHM 46.0°
 Efficiency 91 %
 Peak intensity 1.6 cd/lm
 LEDs/each optic 1
 Light colour White
 Required components:

CREE

LED XP-G2
 FWHM 47.0°
 Efficiency 87 %
 Peak intensity 1.4 cd/lm
 LEDs/each optic 1
 Light colour White
 Required components:

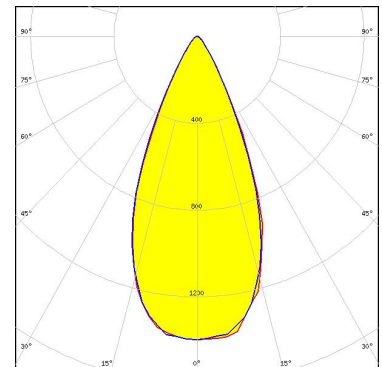
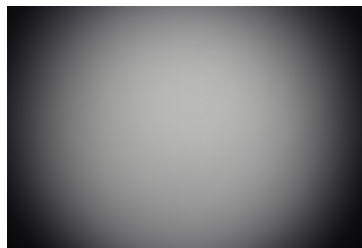

CREE

LED XP-L HD
 FWHM 49.0°
 Efficiency 85 %
 Peak intensity 1.2 cd/lm
 LEDs/each optic 1
 Light colour White
 Required components:

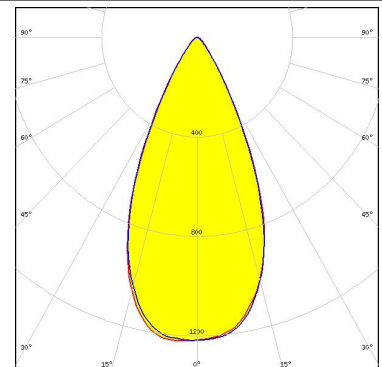
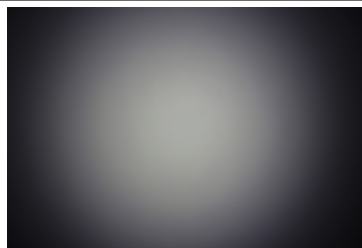

CREE

LED XP-L2
 FWHM 46.0°
 Efficiency 83 %
 Peak intensity 1.3 cd/lm
 LEDs/each optic 1
 Light colour White
 Required components:

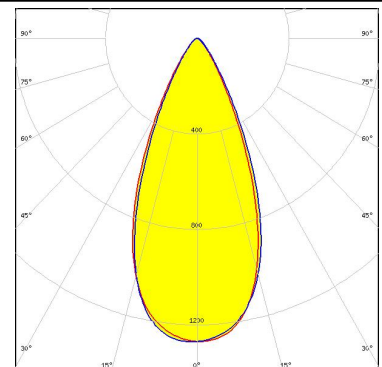
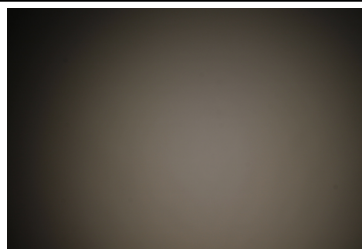

PHOTOMETRIC DATA (MEASURED):



LED XT-E
 FWHM 43.0°
 Efficiency 87 %
 Peak intensity 1.6 cd/lm
 LEDs/each optic 1
 Light colour White
 Required components:

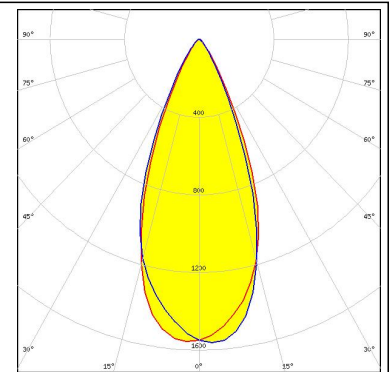
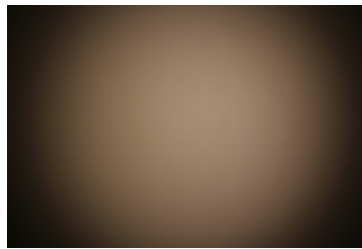

LED LUXEON 3030 2D (Round LES)
 FWHM 37.0°
 Efficiency 86 %
 Peak intensity 1.9 cd/lm
 LEDs/each optic 1
 Light colour White
 Required components:

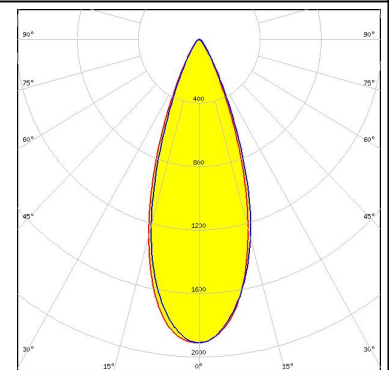
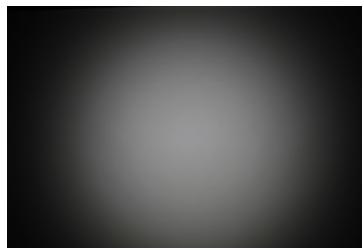

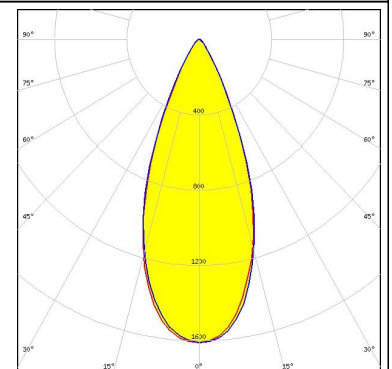
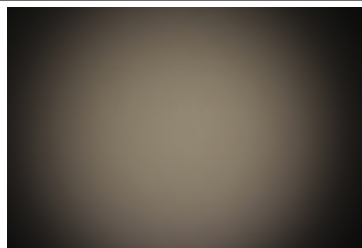

LED LUXEON TX
 FWHM 42.0°
 Efficiency 86 %
 Peak intensity 1.6 cd/lm
 LEDs/each optic 1
 Light colour White
 Required components:

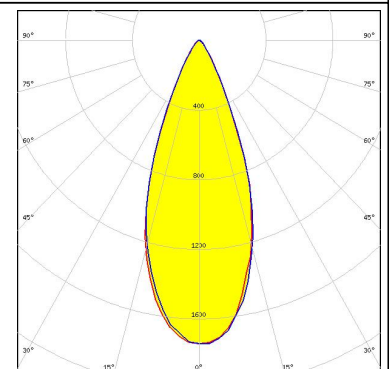
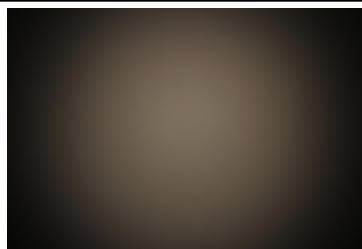

LED NCSxx19A
 FWHM 41.0°
 Efficiency 88 %
 Peak intensity 1.7 cd/lm
 LEDs/each optic 1
 Light colour White
 Required components:

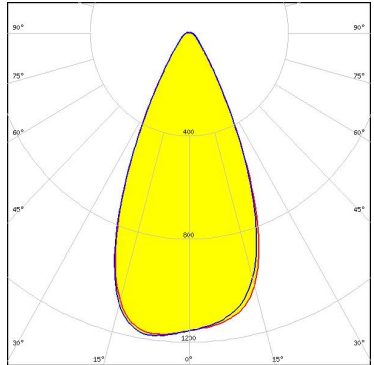
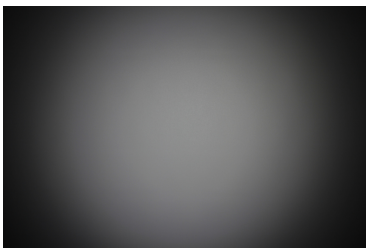
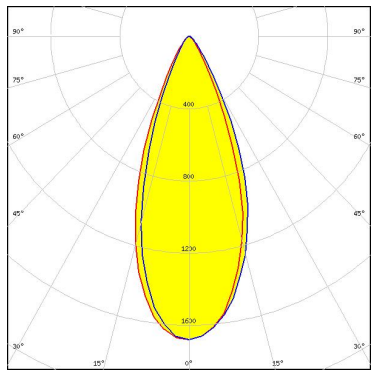

PHOTOMETRIC DATA (MEASURED):

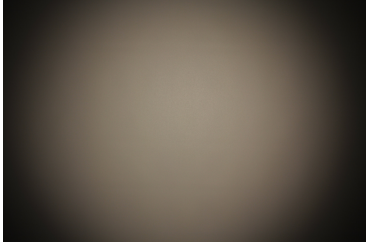
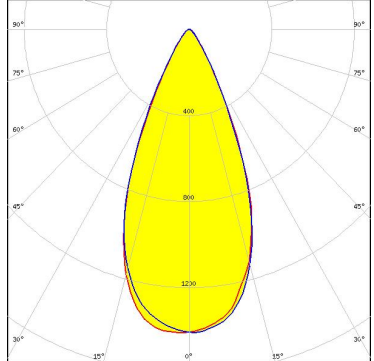
<p>NICHIA</p> <p>LED NVSW219F FWHM 48.0° Efficiency 91 % Peak intensity 1.2 cd/lm LEDs/each optic 1 Light colour White Required components:</p>		
<p>NICHIA</p> <p>LED NVSxx19A FWHM 41.0° Efficiency 87 % Peak intensity 1.7 cd/lm LEDs/each optic 1 Light colour White Required components:</p>		
<p>NICHIA</p> <p>LED NVSxx19B/NVSxx19C FWHM 41.0° Efficiency 84 % Peak intensity 1.7 cd/lm LEDs/each optic 1 Light colour White Required components:</p>		
<p>OSRAM <small>Opto Semiconductors</small></p> <p>LED OSLOM Square EC FWHM 46.0° Efficiency 87 % Peak intensity 1.4 cd/lm LEDs/each optic 1 Light colour White Required components:</p>		

PHOTOMETRIC DATA (MEASURED):

SAMSUNG

LED LH351D
FWHM 52.0°
Efficiency 92 %
Peak intensity 1 cd/Im
LEDs/each optic 1
Light colour White
Required components:

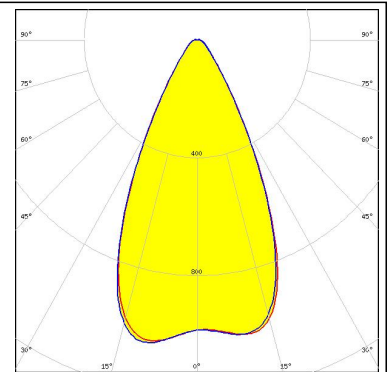

SEOUL SEMICONDUCTOR

LED Z5M3
FWHM 43.0°
Efficiency 92 %
Peak intensity 1.4 cd/Im
LEDs/each optic 1
Light colour White
Required components:

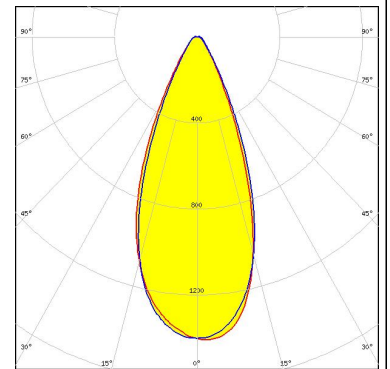

PHOTOMETRIC DATA (SIMULATED):



LED XHP35 HI
FWHM 45.0°
Efficiency 93 %
Peak intensity 1.7 cd/lm
LEDs/each optic 1
Light colour White
Required components:

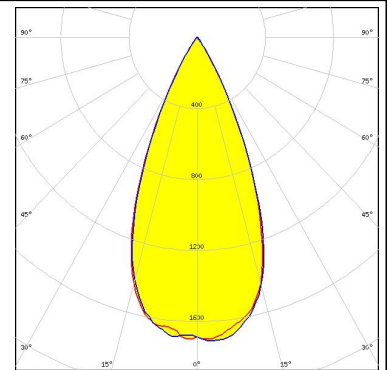

LED XQ-E HI
FWHM 46.0°
Efficiency 95 %
Peak intensity 2.1 cd/lm
LEDs/each optic 1
Light colour White
Required components:

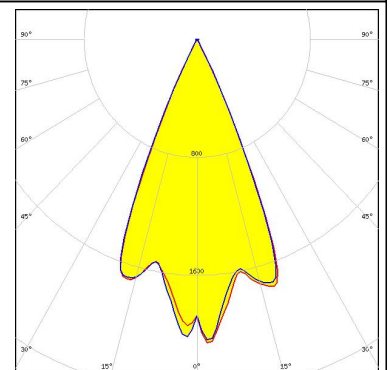

LED OSLON Black
FWHM 41.0°
Efficiency 95 %
Peak intensity 2.3 cd/lm
LEDs/each optic 1
Light colour White
Required components:

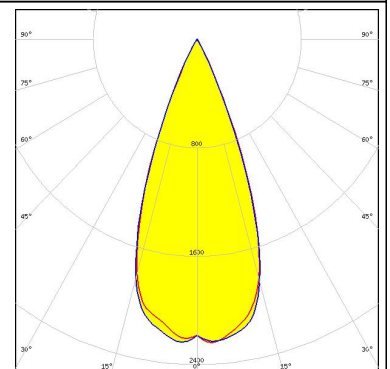

LED OSLON Black Flat
FWHM 34.0°
Efficiency 94 %
Peak intensity 2.9 cd/lm
LEDs/each optic 1
Light colour White
Required components:

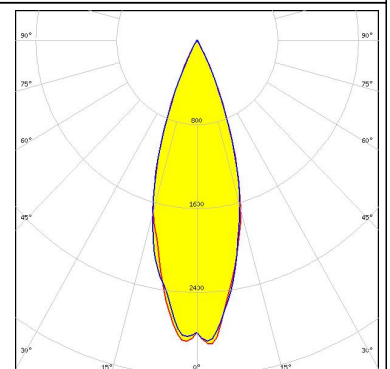

PHOTOMETRIC DATA (SIMULATED):

OSRAM
Opto Semiconductors

LED OSLO[®]N Square Flat
FWHM 41.0°
Efficiency 94 %
Peak intensity 2.2 cd/lm
LEDs/each optic 1
Light colour White
Required components:

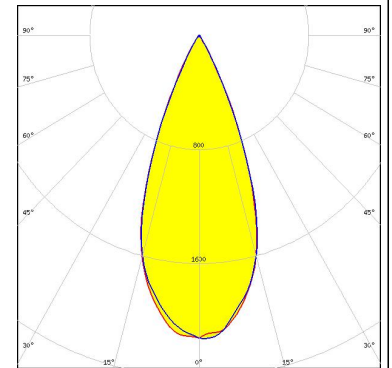

OSRAM
Opto Semiconductors

LED SFH 4770S
FWHM 27.0°
Efficiency 93 %
LEDs/each optic 1
Light colour White
Required components:



SEOUL SEMICONDUCTOR

LED Z8Y22P
FWHM 40.0°
Efficiency 98 %
Peak intensity 2.2 cd/lm
LEDs/each optic 1
Light colour White
Required components:

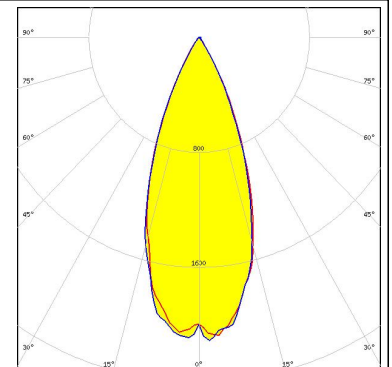

GENERAL INFORMATION:

NOTE: The typical beam angle will be changed by different color, chip size and chip position tolerance. The typical total beam angle is the full angle measured where the luminous intensity is half of the peak value.

MATERIALS:

As part of our continuous research and improvement processes, and to ensure the best possible quality and availability of our products, LEDiL reserves the right to change material grades without notice.

PRODUCT DATA USER AGREEMENT AND DISCLAIMER:

The measured data in the provided downloadable LEDiL Product Datasheets and Mechanical 2D-Drawings is rounded and provided as reference for planning. LEDiL Oy's optical specifications have been verified by conducting performance testing of the products in accordance with the company's quality system. The reported data are averaged results of multiple measurements with typical variation. LEDiL Oy reserves the right to without prior notification make changes and improvements to its products.

LEDiL Oy assumes neither warranty, nor guarantee nor any other liability of any kind for the contents and correctness of the provided data. The provided data has been generated with highest diligence but the provided data may in reality not represent the complete possible variation range of all intrinsic parameters. Therefore, in certain cases a deviation from the provided data could occur.

LEDiL Oy reserves the right to undertake technical changes of its products without further notification which could lead to changes in the provided data. LEDiL Oy assumes no liability of any kind for the possible deviation from any provided data or any other damage resulting from the usage of the provided data.

The user agrees to this disclaimer and user agreement with the download or usage of the provided files.

LEDiL Oy

Joensuunkatu 13
FI-24240 SALO
Finland

LEDiL Inc.

228 West Page Street
Suite D
Sycamore IL 60178
USA

Local sales and technical support

[www.ledil.com/
where_to_buy](http://www.ledil.com/where_to_buy)

Shipping locations

Salo, Finland
Hong Kong, China

Distribution Partners

[www.ledil.com/
where_to_buy](http://www.ledil.com/where_to_buy)



Стандарт Электрон Связь

Мы молодая и активно развивающаяся компания в области поставок электронных компонентов. Мы поставляем электронные компоненты отечественного и импортного производства напрямую от производителей и с крупнейших складов мира.

Благодаря сотрудничеству с мировыми поставщиками мы осуществляем комплексные и плановые поставки широчайшего спектра электронных компонентов.

Собственная эффективная логистика и склад в обеспечивает надежную поставку продукции в точно указанные сроки по всей России.

Мы осуществляем техническую поддержку нашим клиентам и предпродажную проверку качества продукции. На все поставляемые продукты мы предоставляем гарантию .

Осуществляем поставки продукции под контролем ВП МО РФ на предприятия военно-промышленного комплекса России , а также работаем в рамках 275 ФЗ с открытием отдельных счетов в уполномоченном банке. Система менеджмента качества компании соответствует требованиям ГОСТ ISO 9001.

Минимальные сроки поставки, гибкие цены, неограниченный ассортимент и индивидуальный подход к клиентам являются основой для выстраивания долгосрочного и эффективного сотрудничества с предприятиями радиоэлектронной промышленности, предприятиями ВПК и научно-исследовательскими институтами России.

С нами вы становитесь еще успешнее!

Наши контакты:

Телефон: +7 812 627 14 35

Электронная почта: sales@st-electron.ru

Адрес: 198099, Санкт-Петербург,
Промышленная ул, дом № 19, литера Н,
помещение 100-Н Офис 331