

Single-Phase Overcurrent/Undercurrent Relay K8DT-AW

Detect errors in motors and other equipment through current changes.

Monitor for overcurrents and undercurrents simultaneously with one Relay.

- Monitor AC or DC currents with one Relay.
- Use with commercially available CTs (CT secondary side: 0 to 1 A or 0 to 5 A).
- Width of 17.5 mm to reduce space required in panels.
- Push-In Plus Terminal Blocks that reduce wiring work.
- Models added with transistor outputs for superior contact reliability.



For the most recent information on models that have been certified for safety standards, refer to your OMRON website.

 Refer to *Safety Precautions* on page 10.
Refer to page 9 for commonly asked questions.

Ordering Information

Single-phase Overcurrent /Undercurrent Relay

| Setting range | Power supply voltage | Output | Model |
|--|----------------------|----------------------------|------------|
| 2 to 20 mA AC/DC 10 to 100 mA AC/DC 50 to 500 mA AC/DC | 24 VAC/DC | Relay: SPDT contact output | K8DT-AW1CD |
| | | Transistor: NPN output | K8DT-AW1TD |
| | 100 to 240 VAC | Relay: SPDT contact output | K8DT-AW1CA |
| | | Transistor: NPN output | K8DT-AW1TA |
| 0.1 to 1 A AC/DC 0.5 to 5 A AC/DC | 24 VAC/DC | Relay: SPDT contact output | K8DT-AW2CD |
| | | Transistor: NPN output | K8DT-AW2TD |
| | 100 to 240 VAC | Relay: SPDT contact output | K8DT-AW2CA |
| | | Transistor: NPN output | K8DT-AW2TA |
| 10 to 100 A AC * 20 to 200 A AC * | 24 VAC/DC | Relay: SPDT contact output | K8DT-AW3CD |
| | | Transistor: NPN output | K8DT-AW3TD |
| | 100 to 240 VAC | Relay: SPDT contact output | K8DT-AW3CA |
| | | Transistor: NPN output | K8DT-AW3TA |

* The K8DT-AW3□□ is designed to be used in combination with an OMRON K8AC-CT200L Current Transformer (CT). (Direct input is not possible.)

Accessories (Order Separately)

●OMRON Current Transformer

| Appearance | Input range | Applicable Relay | Model |
|---|-----------------------------------|------------------|-------------|
|  | 10 to 100 A AC, 20 to 200 A AC | K8DT-AS3 | K8AC-CT200L |

Front Cover

| Appearance | Model |
|---|----------|
|  | Y92A-D1A |

●Commercially Available Current Transformers*

| Appearance | CT current on secondary side | Applicable Relay |
|---|------------------------------|------------------|
|  | 0 to 1 A AC, 0 to 5 A AC | K8DT-AS2 |

* If you use a commercially available CT, do not exceed the overload capacity of the K8DT-AS2.

K8DT-AW

Ratings and Specifications

Input Range

| Model | Range * 1 | Connection terminals | Setting range | Input impedance | Input type | Overload capacity |
|------------|-------------------|----------------------|--------------------|----------------------------------|---|---|
| K8DT-AW1□□ | 0 to 20 mA AC/DC | I1-COM | 2 to 20 mA AC/DC | Approx. 5Ω | Direct input | Continuous input at 120% of maximum input. 1 s at 150% |
| | 0 to 100 mA AC/DC | I2-COM | 10 to 100 mA AC/DC | Approx. 1Ω | | |
| | 0 to 500 mA AC/DC | I3-COM | 50 to 500 mA AC/DC | Approx. 0.2Ω | | |
| K8DT-AW2□□ | 0 to 1 A AC/DC | I1-COM | 0.1 to 1 A AC/DC | Approx. 0.12 Ω (Load: 0.5 VA) | Direct input or commercially available CT | |
| | 0 to 5 A AC/DC | I2-COM | 0.5 to 5 A AC/DC | Approx. 0.02 Ω (Load: 1.5 VA) | | |
| K8DT-AW3□□ | 0 to 100 A AC | I2-COM | 10 to 100 A AC *2 | --- | OMRON CT | |
| | 0 to 200 A AC | I3-COM | 20 to 200 A AC *2 | --- | | |

*1. The range is selected using connected terminals.

*2. The K8DT-AW3 is designed to be used in combination with an OMRON K8AC-CT200L Current Transformer (CT). (Direct input is not possible.)

Ratings

| | |
|---|---|
| Power supply voltage | K8DT-AW□□D: 24 VAC 50/60Hz, 24 VDC K8DT-AW□□A: 100 to 240 VAC 50/60Hz |
| Power consumption | 24 VAC/24 VDC: 1.8 VA/1 W max. 100 to 240 VAC: 2.5 VA max. |
| Rated insulation voltage | 600 VAC |
| Operating value setting range (AL1, AL2) | 10% to 100% of the maximum value of the setting range K8DT-AW1: 2 to 20 mA AC/DC 10 to 100 mA AC/DC 50 to 500 mA AC/DC K8DT-AW2: 0.1 to 1 A AC/DC (Compatible with commercially available CTs.) 0.5 to 5 A AC/DC (Compatible with commercially available CTs.) K8DT-AW3: When used with the OMRON CT (K8AC-CT200L). 10 to 100 A AC 20 to 200 A AC |
| Operating value | 100% operation at set value |
| Reset value | 5% of operating value (fixed) |
| Reset method | Manual reset/automatic reset (switchable) Note: Manual reset: Turn OFF power supply for 1 s or longer. |
| Operating time setting range (T) | 0.1 to 30 s |
| Startup lock time setting range (LOCK) | 0 to 30 s (The startup lock timer starts when the input has reached approximately 30% or more of the set value.) Note: Enabled only for overcurrent operation. |
| Indicators | Power (PWR): Green, Output (OUT): Yellow, Alarm output 1 (ALM1): Red, Alarm output 2 (ALM2): Red |
| Input impedance | Refer to <i>Input Range</i> on page 2. |
| Output form | Relay: SPDT contact output Transistor: NPN output |
| Output relay ratings | Rated load: 250 VAC 5 A or 30 VDC 5 A (resistive load), 250 VAC 1 A (inductive load), 48 VDC 0.2 A (inductive load) Minimum load: 5 VDC, 10 mA (reference values) Mechanical life: 10 million operations min. Electrical life: 5 A at 250 VAC or 30 VDC: 50,000 operations 3 A at 250 VAC or 30 VDC: 100,000 operations |
| Transistor output ratings | Contact form: SPST-NO (NPN transistor) Rated voltage: 24 VDC (maximum voltage: 26.4 VDC) Maximum current: 50 mA DC |
| Ambient operating temperature | -20 to 60°C (with no condensation or icing) |
| Storage temperature | -25 to 65°C (with no condensation or icing) |
| Ambient operating humidity | 25% to 85% RH (with no condensation) |
| Storage humidity | 25% to 85% RH (with no condensation) |
| Altitude | 2,000 m max. |
| Applicable wires | Stranded wires or ferrules |
| Applicable wire size | 0.25 to 1.5 mm ² (AWG24 to AWG16) |
| Wire insertion force | 8 N max. for AWG20 wire |
| Screwdriver insertion force | 15 N max. |
| Wire stripping length | 8 mm |
| Ferrule length | 8 mm |
| Recommended flat-blade screwdriver | XW4Z-00B (Omron) SZF 0.4 × 2.5 (Phoenix Contact) 210-719 (Wago) SDI 0.4 × 2.5 × 75 (Weidmuller) |
| Current capacity | 10 A (per pole) |
| Number of insertions | 50 times |
| Case color | N1.5 |
| Case material | PC, UL 94 V-0 |
| Weight | Approx. 100 g |
| Mounting | Mounts to DIN Track, or screw mounting |
| Dimensions | 17.5 × 90 × 90 mm (W×H×D) |

Specifications

| | | |
|--|--|---|
| Allowable operating voltage range | 85% to 110% of power supply voltage | |
| Allowable operating frequency range | 50/60 Hz ±5 Hz | |
| Input frequency range | K8DT-AW1 and K8DT-AW2: DC input or AC input (45 to 65 Hz) K8DT-AW3: AC input (45 to 65 Hz) | |
| Overload capacity | K8DT-AW1 and K8DT-AW2: Continuous input at 120% of maximum input, 1 s at 150% K8DT-AW3: Continuous input at 120%, 30 s at 200%, and 1 s at 600% with an OMRON CT (K8AC-CT200L). Note: CT capacity on primary side. | |
| Repeat accuracy | Operating value | ±0.5% full scale (at 25°C and 65% humidity, rated power supply voltage, DC or 50/60 Hz sine wave input) |
| | Operating time | ±50 ms (at 25°C and 65% humidity, rated power supply voltage) |
| Applicable standards | Conforming standards | EN 60947-5-1 Installation environment (pollution level 2, Overvoltage category III) |
| | EMC | EN 60947-5-1 |
| | Safety standards | UL 60947-5-1 (Listing), Korean Radio Waves Act (Act 10564), CCC (GB14048.5) |
| Insulation resistance | 20 MΩ min. Between external terminals and case Between power supply terminals and input terminals Between power supply terminals and output terminals Between input terminals and output terminals | |
| Dielectric strength | 2,000 VAC for one minute Between external terminals and case Between power supply terminals and input terminals Between power supply terminals and output terminals Between input terminals and output terminals | |
| Impulse withstand voltage | 6 kV (between live terminals and exposed, non-charged metal parts) | |
| Noise immunity | Square-wave noise of 1-μs/100-ns pulse width with 1-ns rise time 100 to 240 VAC: 1,500 V power supply terminal common/normal mode 24 VAC: 1,500 V power supply terminal common/normal mode 24 VDC: 480 V power supply terminal common | |
| Vibration resistance | Frequency: 10 to 55 Hz, 0.35-mm single amplitude, acceleration 50 m/s ² 10 sweeps of 5 min each in X, Y, and Z directions | |
| Shock resistance | 100 m/s ² , 3 times each in 6 directions along 3 axes | |
| Degree of protection | Terminals: IP20 | |

K8DT-AW

Connections

Terminal Diagram

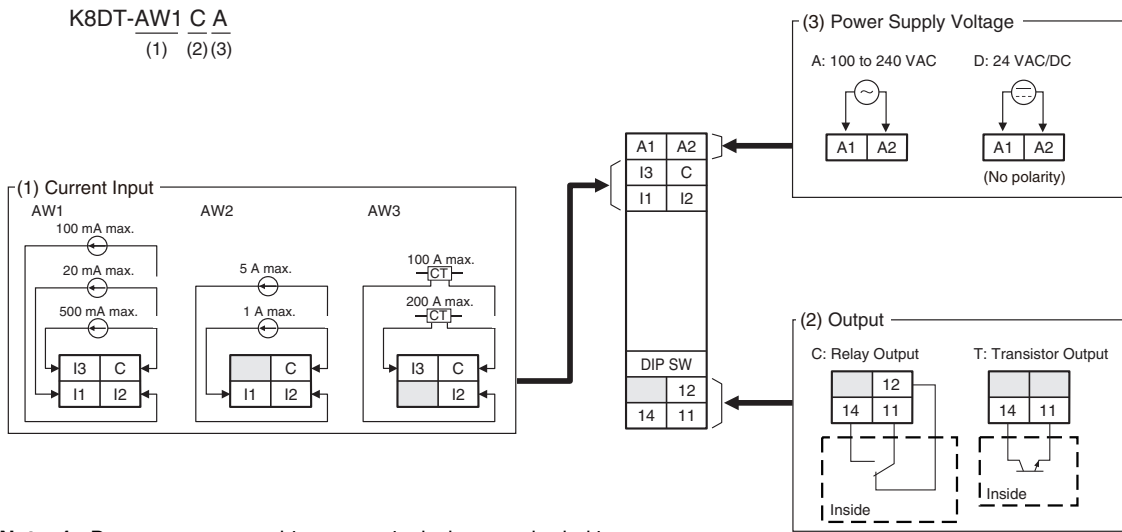

- Note:**
1. Do not connect anything to terminals that are shaded in gray.
 2. There is no polarity for the DC power supply input.
 3. For the current input, you can input only from the C terminal and one other terminal.
 4. Refer to *Setting Ranges and Wiring Connections* on the I1, I2, and I3 current input terminals.
 5. The K8DT-AW3 is designed to be used in combination with the OMRON K8AC-CT200L Current Transformer (CT).

Wiring Example

Directly Inputting a Current

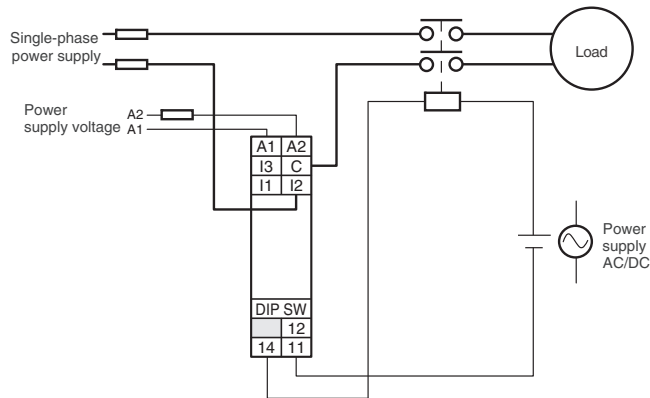

Using a CT

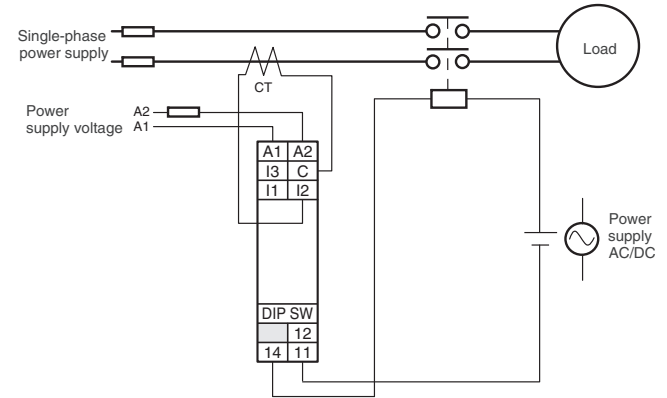

Transistor Output

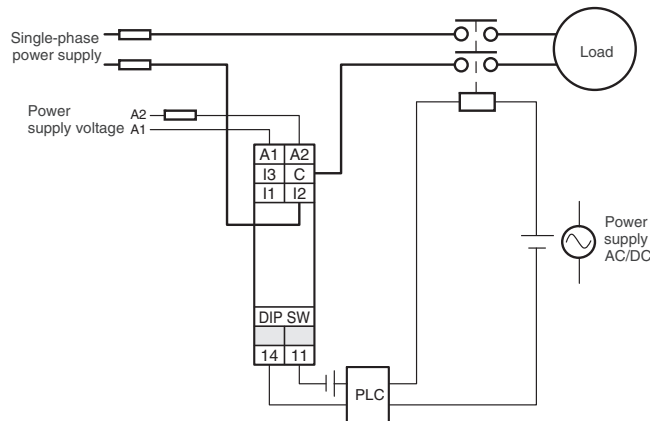

- Note:** Use copper wires with a rating of 75°C or an equivalent rating.

Timing Charts

Overcurrent and Undercurrent Operation Diagram

DIP switch settings: SW3 ON and SW4 ON, or SW3 OFF and SW4 OFF

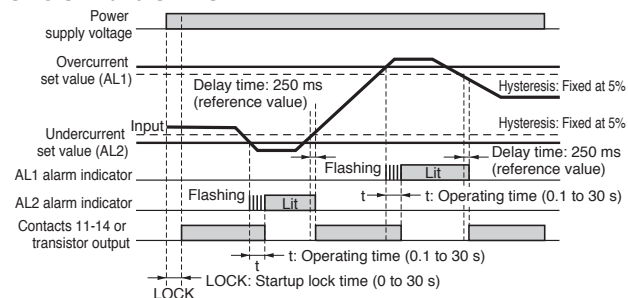

- Note 1. The K8DT-AW□ outputs are normally operative.
- Note 2. The startup lock prevents unnecessary alarms from being generated during the unstable period when the power is first turned ON. This function is valid only for overcurrent operation.

Undercurrent and Undercurrent Operation Diagram

DIP switch settings: SW3 OFF and SW4 ON.

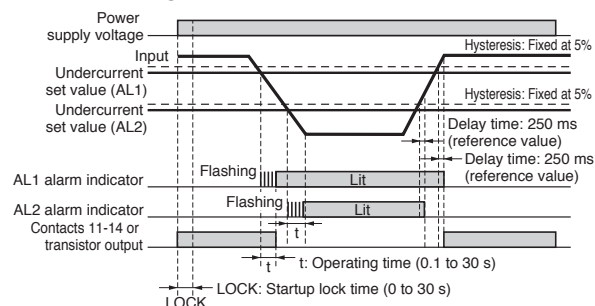

- Note 1. The K8DT-AW□ outputs are normally operative.
- Note 2. The startup lock prevents unnecessary alarms from being generated during the unstable period when the power is first turned ON. This function is valid only for overcurrent operation.

Overcurrent and Overcurrent Operation Diagram

DIP switch settings: SW3 ON and SW4 OFF.

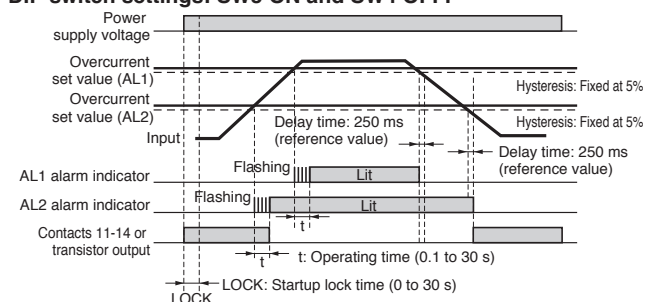

- Note 1. The K8DT-AW□ outputs are normally operative.
- Note 2. The startup lock prevents unnecessary alarms from being generated during the unstable period when the power is first turned ON. This function is valid only for overcurrent operation.

Nomenclature

Front

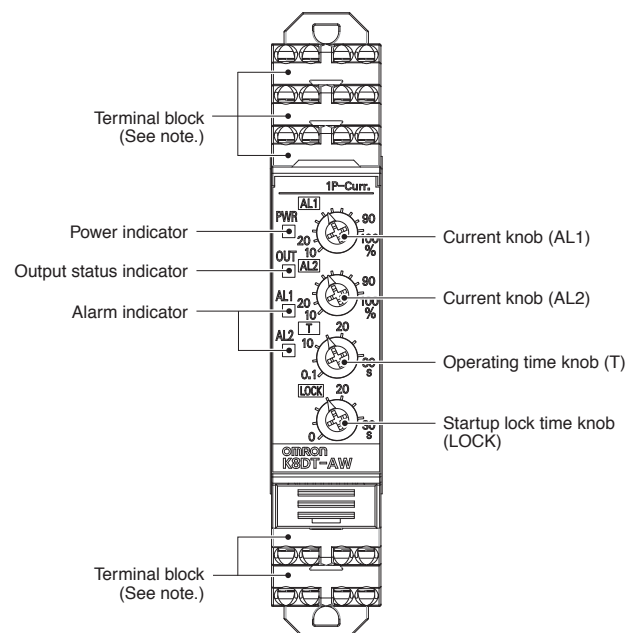

Note: Use stranded wires, with or without ferrules, to connect to the terminals.
To maintain the withstand voltage after connecting the terminals, insert 8 mm of exposed conductor into the terminal.

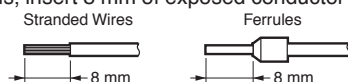

Indicators

| Item | Meaning |
|---|--|
| Power indicator (PWR: Green) | Lit when power is being supplied. |
| Output status indicator (Output: Yellow) | Lit when there is an output (lit for normal operation) |
| Alarm indicator (ALM1, ALM2: Red) | Lit when there is an overcurrent or undercurrent. The indicator flashes to indicate the error status after the input has exceeded the set value while the operating time is being clocked. |

Setting Knobs

| Item | Usage |
|--------------------------------------|--|
| Current knob (AL1) | Used to set the current to 10% to 100% of maximum setting range. |
| Current knob (AL2) | Used to set the current to 10% to 100% of maximum setting range. |
| Operating time knob (T) | Used to set the operating time to 0.1 to 30 s. |
| Startup lock time knob (LOCK) | Used to set the startup lock time to 0 to 30 s. |

K8DT-AW

Operation Methods

Setting Ranges and Wiring Connections

| Model | Setting range | Input type | Wiring connections |
|----------|--------------------|---|--------------------|
| K8DT-AW1 | 2 to 20 mA AC/DC | Direct input | I1-COM |
| | 10 to 100 mA AC/DC | Direct input | I2-COM |
| | 50 to 500 mA AC/DC | Direct input | I3-COM |
| K8DT-AW2 | 0.1 to 1 A AC/DC | Direct input or commercially available CT | I1-COM |
| | 0.5 to 5 A AC/DC | Direct input or commercially available CT | I2-COM |
| K8DT-AW3 | 10 to 100 A AC * | OMRON CT | I2-COM |
| | 20 to 200 A AC * | OMRON CT | I3-COM |

Note: The DC input terminals have no polarity.
 * The K8DT-AW3 is designed to be used in combination with the OMRON K8AC-CT200L Current Transformer (CT). (Direct input is not possible.)

Connections

Input

Connect the input between the I1-COM, I2-COM, or I3-COM terminals, according to the input current. Malfunctions may occur if the input is connected to unused terminals and the Unit will not operate correctly.

For the K8DT-AW3, the I1 terminal is not used. For the K8DT-AW2, the I3 terminal is not used. If using the OMRON K8AC-CT200L CT, connect to terminals k and l on the K8AC-CT200L. (Terminals kt and lt are not used.)

Power Supply

Connect the power supply to terminals A1 and A2.

Outputs

For a relay output, the SPDT contacts are output on terminals 11, 12, and 14. For a transistor output, the NPN output is on terminals 11 and 14.

Do not use the transistor output for control applications. It is designed only to output a signal when an error is detected.

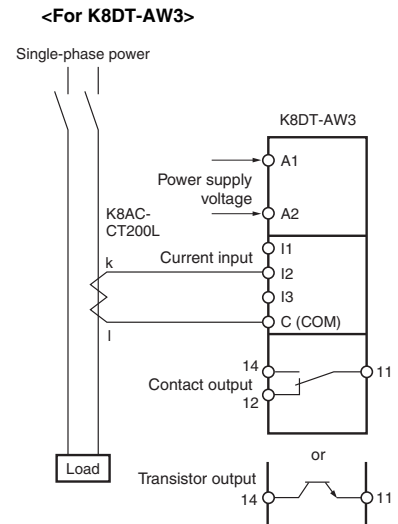

DIP Switch Settings

The reset method and operating mode are set using the DIP switch located on the front of the Unit. K8DT-AW□ does not use SW1.

Note: Open the DIP switch cover to set the DIP switch.

Keep the DIP switch cover closed while the power supply to the Relay is ON.

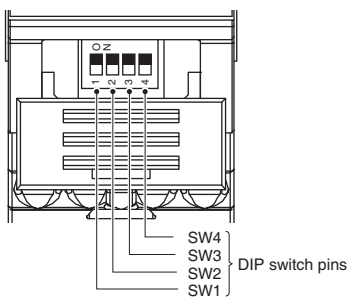

DIP Switch Functions

| Pin | OFF ● ↑ | | | |
|------------------|-----------------|--------------|-----------|-----|
| | 1 | 2 | 3 | 4 |
| Resetting method | Manual reset | ● | --- | --- |
| | Automatic reset | ○ | --- | --- |
| Operating mode | AL1 | AL2 | Not used. | |
| | Overcurrent | Undercurrent | --- | ● |
| | Overcurrent | Overcurrent | --- | ○ |
| | Undercurrent | Undercurrent | --- | ● |
| | Overcurrent | Undercurrent | --- | ○ |

Note: All pins are set to OFF at the factory.

Setting Method

Setting Current

The current knobs (AL1, AL2) are used to set the current.

The current can be set to 10% to 100% of the maximum setting range.

Turn the knob while there is an input to the input terminals until the alarm indicator flashes (when the set value and the input have reached the same level.)

Use this as a guide to set the current.

The maximum setting range will differ depending on the model and the input terminal.

Example: K8DT-AW3 Using Input Terminals I3-COM

The maximum measuring current will be 200 A AC and the setting range will be 20 to 200 A.

Operating Time

The operating time is set using the operating time knob (T).

The operating time can be set to between 0.1 and 30 s.

Turn the knob while there is an input to the input terminals until the alarm indicator flashes (when the set value and the input have reached the same level.)

If the input current exceeds (drops lower than) the set value, the alarm indicator will start flashing for the set period and then stay lit.

Startup Lock Time

The startup lock time is set using the startup lock time knob (LOCK).

The startup lock time can be set to between 0 and 30 s.

Turn the knob while there is an input to the input terminals until the alarm indicator flashes (when the set value and the input have reached the same level.)

The startup lock time will start when the input current reaches 30% or more of the set value. Use startup lock time to prevent unwanted operation, e.g., as a result of inrush current.

Note: This function is valid only for overcurrent operation.

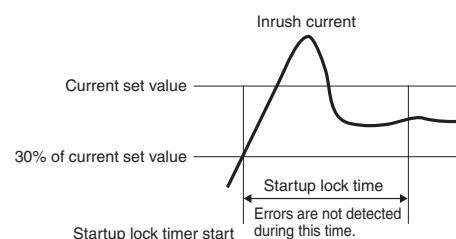

K8DT-AW

Dimensions

(Unit: mm)

Single-phase Overcurrent/Undercurrent Relay

K8DT-AW1
K8DT-AW2
K8DT-AW3

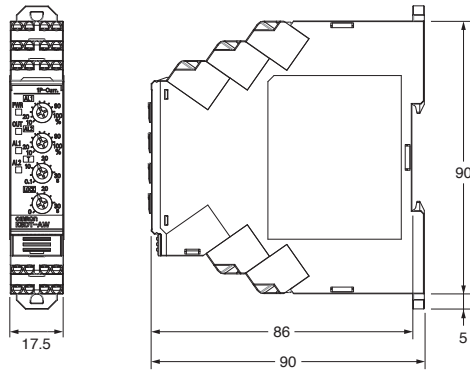

OMRON CT

K8AC-CT200L

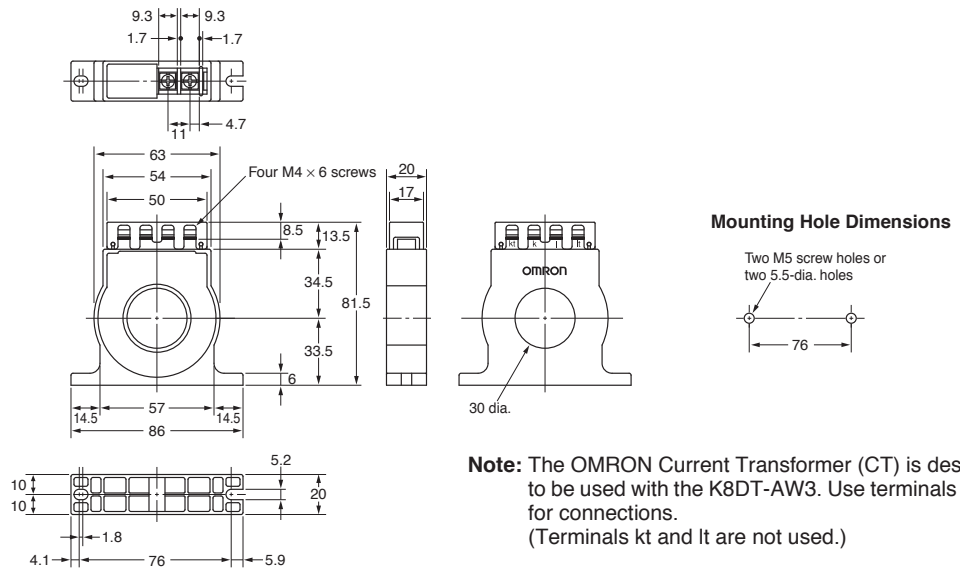

Note: The OMRON Current Transformer (CT) is designed to be used with the K8DT-AW3. Use terminals k and l for connections. (Terminals kt and lt are not used.)

Accessories (Order Separately)

Front Cover

Y92A-D1A

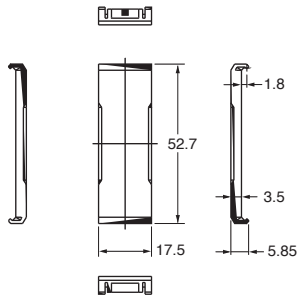
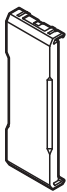

DIN Tracks

PFP-100N

PFP-50N

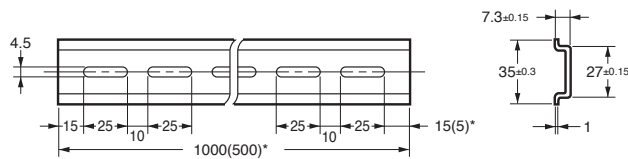
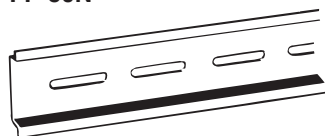

* Dimensions in parentheses are for the PFP-50N.

Questions and Answers

Q Checking Operation

A Overcurrents
 Gradually increase the input from 80% of the set value. The input will equal the operating value when the input exceeds the set value and the alarm indicator starts flashing. Operation can be checked by the relay outputs that will start after the operating time has passed.
 Undercurrent
 Gradually decrease the input from 120% of the set value and check the operation using the same method as for overcurrent.

Example: Overcurrent Operating Mode, Normally Closed Relay Drive, and an Operating Time of 5 s.

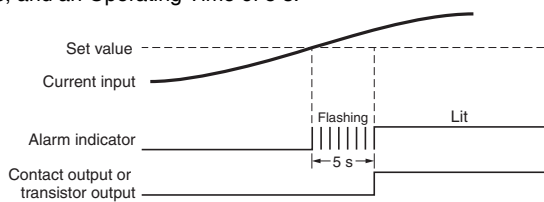

Connection Diagram

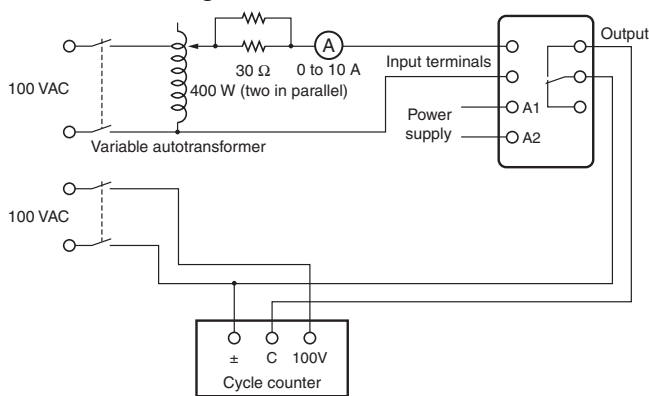

Q How to Measure the Operating Time

A Overcurrent
 Change the input suddenly from 0% to 120% of the set value and measure the time until the Unit operates.
 Undercurrent
 Change the input suddenly from 120% to 0% of the set value and measure the time until the Unit operates.

Q Monitoring Switch-mode Power Supplies

A Switch-mode Power Supplies cannot be monitored. In circuits with a capacitor input, including switch-mode power supplies, the input capacitor recharge current flows in pulse form as the load current. The K8DT-AW□ has a built-in filter as a countermeasure against high frequencies and cannot be used to remove pulse current.

Q Can a motor with a rated current of 5 A be monitored using the K8DT?
 Are there any application precautions?

A The K8DT-AW1 and K8DT-AW2 cannot be used with motor loads. Use the K8DT-AW3 in combination with the K8AC-CT200L Current Transformer (CT). With motor loads, the startup current and stall current will cause a current of many times the rated current to flow. Refer to the following figure for information on the motor startup current.

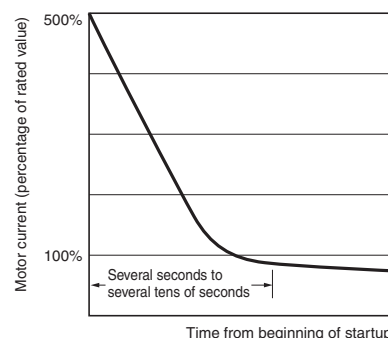

For a motor with a rating of 5 A, the startup current will be approximately 30 A. The startup current will exceed the overload capacity (rating: 150% for 1 s) of the K8DT-AW1 and K8DT-AW2 and result in failure of the Relay. To monitor the motor load, use the K8DT-AW3. (Overload capacity: 120% of rating for continuous load, 200% of rating for 30 s, and 600% of rating for 1 s). The K8DT-AW3 has a large input range. Pass the conductors multiple times through the special CT.

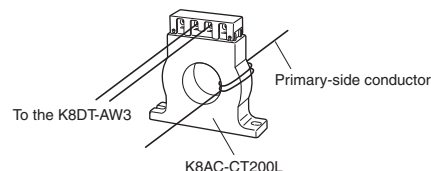

Concept behind Passing Conductor through the CT When Using the K8DT-AW3

Example: Monitoring Overload of a Motor with a Rated Current of 5 A
 K8DT set value:
 Overcurrent detection, operating value setting: 25%, operating time: 0.1 s
 Startup lock timer: 0.1 to 30 s (Set the timer according to the duration of the startup current.)

The setting range for the K8DT-AW3 is 10% to 100% of the rated current (i.e., 10 to 100 A). Pass the conductors through the CT five times so that at least 10 A of current flows. The input current to the K8DT will be 25 A (i.e., 5 A x 5 loops). If a startup current of six times the rated current is generated, it will be 150 A (i.e., 25 A x 6). The overload capacity for the K8DT-AW3 is 200% of the rating for 30 s. The Relay will not fail even if the startup current continues for 30 s, and it is possible to perform overload detection.





Safety Precautions

Be sure to read the precautions for all models in the website at the following URL: <http://www.ia.omron.com/>.

Warning Indications

| | |
|--|---|
|  CAUTION | Indicates a potentially hazardous situation which, if not avoided, may result in minor or moderate injury or in property damage. |
| Precautions for Safe Use | Supplementary comments on what to do or avoid doing, to use the product safely. |
| Precautions for Correct Use | Supplementary comments on what to do or avoid doing, to prevent failure to operate, malfunction, or undesirable effects on product performance. |

Meaning of Product Safety Symbols

| | |
|---|---|
|  | Used to warn of the risk of electric shock under specific conditions. |
|  | Used for general prohibitions for which there is no specific symbol. |
|  | Used to indicate prohibition when there is a risk of minor injury from electrical shock or other source if the product is disassembled. |
|  | Used for general mandatory action precautions for which there is no specified symbol. |

CAUTION

Doing so may occasionally result in minor injury due to electric shock. Do not touch the Relay while the power supply is ON, except for the adjustment knob.



There is a risk of minor electrical shock, fire, or device failure. Do not allow any pieces of metal, conductors, or cutting chips that occur during the installation process to enter the product.



Explosions may cause minor injuries. Do not use the product in locations with inflammable or explosive gases.

There is a risk of minor electrical shock, fire, or device failure. Do not disassemble, modify, repair, or touch the inside of the product.



Use of the product beyond its life may result in contact welding or burning. Make sure to consider the actual operating conditions and use the product within its rated load and electrical life count. The life of the output relay varies significantly with the switching capacity and switching conditions.



If the Relay is used with incorrect wiring, fire may occasionally occur, possibly resulting in physical damage. Check the wiring for mistakes before you turn ON the power supply.



If the Relay fails, monitoring and alarm outputs may fail to operate. This may result in physical damage to the facilities, equipment, or other devices that are connected to it. To reduce this risk, inspect the Relay regularly. To maintain safety in the event of malfunction of the Relay, take appropriate safety measures, such as installing a monitoring device on a separate line.



If the wire insertion length is insufficient, fire may occasionally occur, possibly resulting in physical damage. Insert the wires all the way to the back.



The terminal block may be damaged if you insert a flat-blade screwdriver in the release hole with excessive force. Insert the flat-blade screwdriver into the release holes with a force of 15 N or less.



Precautions for Safe Use

- Do not use or store the product in the following locations.
 - Locations subject to water or oil
 - Outdoor locations or under direct sunlight
 - Locations subject to dust or corrosive gases (sulfurizing gases, ammonia gases, etc.)
 - Locations subject to rapid temperature changes
 - Locations prone to icing and dew condensation
 - Locations subject to vibration and large shocks
 - Locations subject to wind and rain
 - Locations subject to static electricity or noise
 - Locations subject to insects or small animals
 - Locations subject to direct radiant heat from heating equipment
- Use and store the product in a location where the ambient temperature and humidity are within the specified ranges. If applicable, provide forced cooling.
- Check terminal polarity when wiring and wire all connections correctly. The power supply terminals do not have polarity.
- Do not wire the input and output terminals incorrectly.
- Make sure the power supply voltage and loads are within the specifications and ratings for the product.
- Make sure the ferrule terminals for wiring are of the specified size.
- Make sure the stripping length is 8 mm. Insert the wires all the way to the back.
- Do not connect anything to terminals that are not being used.
- Use a power supply that will reach the rated voltage within 1 second after the power is turned ON.
- Keep wiring separate from high voltages and power lines that draw large currents. Do not place product wiring in parallel with or in the same path as high-voltage or high-current lines.
- Do not install the product near equipment that generates high frequencies or surges.
- The product may cause incoming radio wave interference. Do not use the product near radio wave receivers.
- Install an external switch or circuit breaker and label it clearly so that the operator can quickly turn OFF the power supply.
- Make sure the indicators operate correctly. Depending on the application environment, the indicators may deteriorate prematurely and become difficult to see.
- Do not use the product if it is accidentally dropped. The internal components may be damaged.
- Be sure you understand the contents of this catalog and handle the product according to the instructions provided.
- Do not install the product in any way that would place a load on it.
- When discarding the product, properly dispose of it as industrial waste.
- When using the product, remember that the power supply terminals carry a high voltage.
- The product must be handled only by trained electricians.
- Prior to operation, check the wiring before you supply power to the product.
- Do not install the product immediately next to heat sources.
- Perform periodic maintenance.
- Do not wire anything to the release holes.
- When you insert a flat-blade screwdriver into a release hole, do not tilt or twist the screwdriver. The terminal block may be damaged.
- Insert a flat-blade screwdriver into the release holes at an angle. The terminal block may be damaged if the screwdriver is inserted straight in.
- Do not allow the flat-blade screwdriver to fall when you are holding it in a release hole.
- Do not bend a wire past its natural bending radius or pull in it with excessive force. Doing so may break the wires.
- Do not insert more than one wire into each terminal insertion hole.

- To prevent wire materials from smoking or igniting, use the wiring materials given in the following table.

| Recommended wire | Stripping length | |
|---|------------------|------------------|
| | With Ferrules | Without Ferrules |
| 0.25 to 1.5mm ² /Equivalent to AWG24 to 16 | 10 mm | 8 mm |

Note: Please use Ferrules with UL certification (R/C).

- Use only the specified wires for wiring.
- When wiring the terminals, allow some leeway in the wire length.
- Make sure that the power supply is turned OFF before you change any DIP switch setting.

Precautions for Correct Use

Observe the following operating methods to prevent failure and malfunction.

- Use the power supply voltage, input power, and other power supplies and converters with suitable capacities and rated outputs.
- The distortion in the input waveform must be 30% max. If the input waveform is distorted beyond this level, it may cause unnecessary operation.
- Error will be large if the product is used for thyristor or inverter control.
- When cleaning the product, do not use thinners or solvents. Use commercial alcohol.
- If you use stranded wires, make sure that there are no loose wire strands.
- If you wire crossovers and connect terminal blocks in parallel, a large current will flow. Make sure that the current does not exceed 10 A.
- The terminal block may be damaged if the recommended tool is not used. Use the recommended flat-blade screwdriver to operate the release holes.

Correct Mounting Direction, Mounting, and Removing

Mounting to DIN Track

To mount the Relay to a DIN Track, hook the Relay onto the DIN Track and press the Relay in the direction of the arrow until you hear it lock into place.

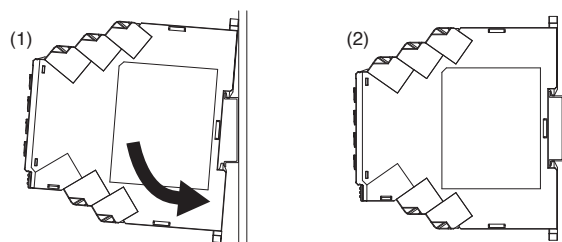

Removing from the DIN Track

To remove the Relay, insert a screwdriver into the hook on the top or bottom and pull out the hook to release the Relay.

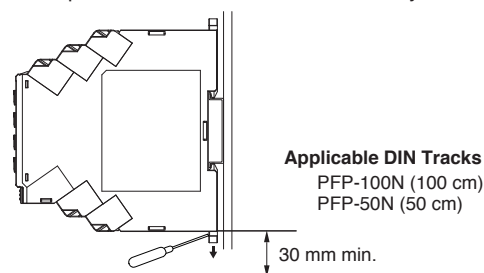

- Leave at least 30 mm of space between the product and other devices to allow easy installation and removal.

Screw Mounting

1. Pull out the two hooks on the back of the Relay to the outside until you hear them click into place.
2. Insert M3 screws into the hook holes and secure the Relay.

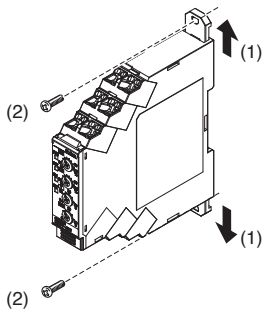

Mounting Hole Dimensions

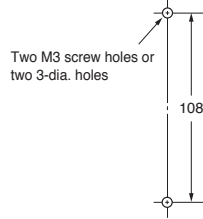

- Note:**
1. Pull out the hooks to mount the Relay with screws.
 2. Recommended tightening torque: 0.5 to 0.6 N·m.

Adjusting the Setting Knobs

- Use a flat-blade screwdriver to adjust the setting knobs. The knobs have a stopper that prevents them from turning beyond the full right or left position. Do not force a knob beyond these points.

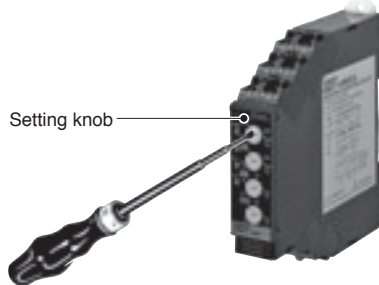

- To reduce the error in the setting knob, always turn the setting knob from the minimum setting toward the maximum setting.

Connecting Wires to the Push-In Plus Terminal Block

Part Names of the Terminal Block

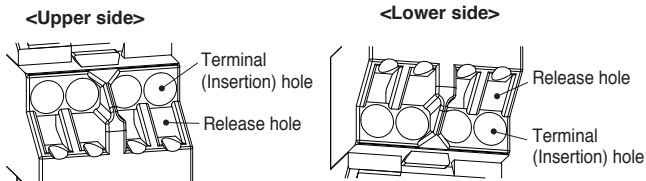

Connecting Wires with Ferrules

Insert the ferrule straight into the terminal block until the end strikes the terminal block.

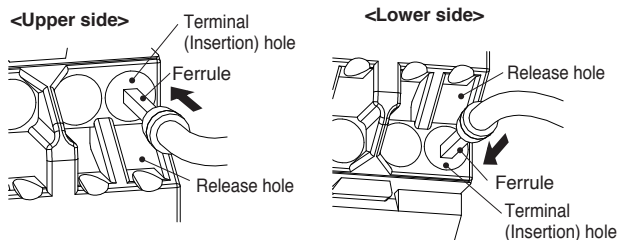

If a wire is difficult to connect because it is too thin, use a flat-blade screwdriver in the same way as when connecting stranded wire.

Connecting Stranded Wires

Use the following procedure to connect the wires to the terminal block.

1. Hold a flat-blade screwdriver at an angle and insert it into the release hole. The angle should be between 10° and 15°. If the flat-blade screwdriver is inserted correctly, you will feel the spring in the release hole respond.
2. With the flat-blade screwdriver still inserted into the release hole, insert the wire into the terminal hole until it strikes the terminal block.
3. Remove the flat-blade screwdriver from the release hole.

<Upper side>

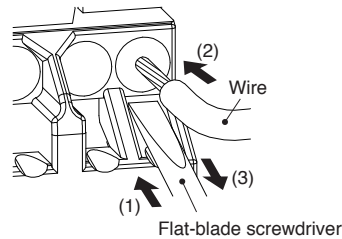

<Lower side>

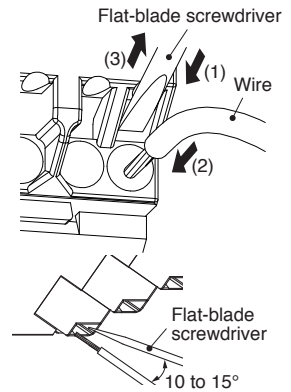

Checking Connections

- After the insertion, pull gently on the wire to make sure that it will not come off and the wire is securely fastened to the terminal block.
- To prevent short circuits, insert the stripped part of a stranded wire or the conductor part of a ferrule until it is hidden inside the terminal insertion hole. (See the following diagram.)

<Upper side>

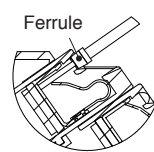

<Upper side>

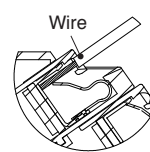

<Lower side>

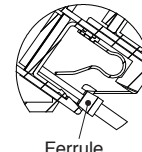

<Lower side>

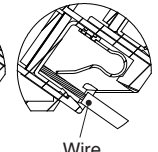

Removing Wires from the Push-In Plus Terminal Block

Use the following procedure to remove wires from the terminal block. The same method is used to remove stranded wires and ferrules.

1. Hold a flat-blade screwdriver at an angle and insert it into the release hole.
2. With the flat-blade screwdriver still inserted into the release hole, remove the wire from the terminal insertion hole.
3. Remove the flat-blade screwdriver from the release hole.

<Upper side>

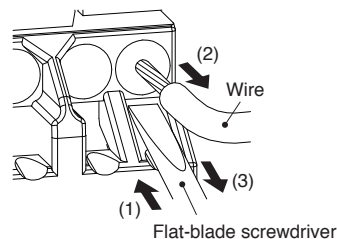

<Lower side>

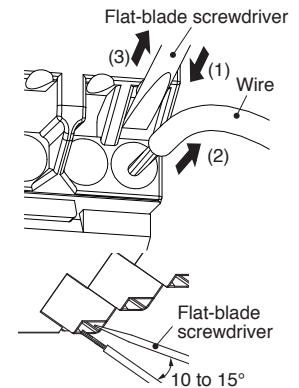

Recommended Ferrules and Tools

Recommended Ferrules

| Wire | | Ferrule length (mm) | Recommended ferrules | | |
|------------------------|-------|---------------------|--|----------------------------|----------------------|
| (mm ²) | (AWG) | | Manufactured by Phoenix Contact | Manufactured by Weidmuller | Manufactured by Wago |
| 0.25 | 24 | 8 | AI0.25-8 | H0.25/12 | FE-0.25-8N-YE |
| 0.34 | 22 | 8 | AI0.34-8 | H0.34/12 | FE-0.34-8N-TQ |
| 0.5 | 20 | 8 | AI0.5-8 | H0.5/14 | FE-0.5-8N-WH |
| 0.75 | 18 | 8 | AI0.75-8 | H0.75/14 | FE-0.75-8N-GY |
| 1 | 18 | 8 | AI1-8 | H1.0/14 | FE-1.0-8N-RD |
| 1.5 | 16 | 8 | AI1.5-8 | H1.5/14 | FE-1.5-8N-BK |
| Recommended crimp tool | | | CRIMPFOX6 CRIMPFOX6T-F CRIMPFOX10S | PZ6 roto | Variocrimp4 |

- Note:**
1. Make sure that the outer diameter of the wire coating is smaller than the inner diameter of the insulation sleeve of the recommended ferrule.
 2. Make sure that the ferrule processing dimensions conform to the following figures.

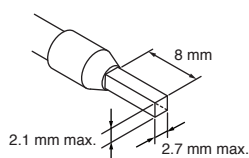

Recommended Flat-blade Screwdriver

Use a flat-blade screwdriver to connect and remove wires.

The following table shows manufacturers and models as of 2015/Dec.

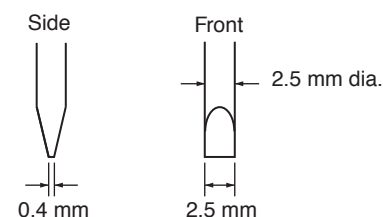

| Model | Manufacturer |
|----------------|-----------------|
| XW4Z-00B | Omron |
| ESD0.40X2.5 | Wera |
| SZF 0.4X2.5 | Phoenix Contact |
| 0.4X2.5X75 302 | Wiha |
| AEF.2.5X75 | Facom |
| 210-719 | Wago |
| SDI 0.4X2.5X75 | Weidmuller |

EN/IEC Standard Compliance

- Refer to the contents of this datasheet for cable selection and other conditions for compliance with EMC standards.

Precaution on EN Standard Compliance

The K8DT complies with EN 60947-5-1 when it is built into a panel, but observe the following handling methods to ensure compliance with the requirements of this standard.

Wiring

Overvoltage category III

Pollution degree 2

- Open-frame Device
- If basic, double, or reinforced insulation is required, use the basic, double, or reinforced insulation defined in IEC 60664 that is suitable for the maximum applied voltage for the clearance, solid insulation, and other factors.
- There is basic insulation between the power supply terminals and input terminals.
- There is basic insulation between the power supply terminals and output terminals.
- There is basic insulation between the input terminals and output terminals.
- Operating section must have reinforced or double insulation.
- The sides of the case are not isolated.
- Connect the output contacts (contacts with different polarity) so that they reach the same potential.

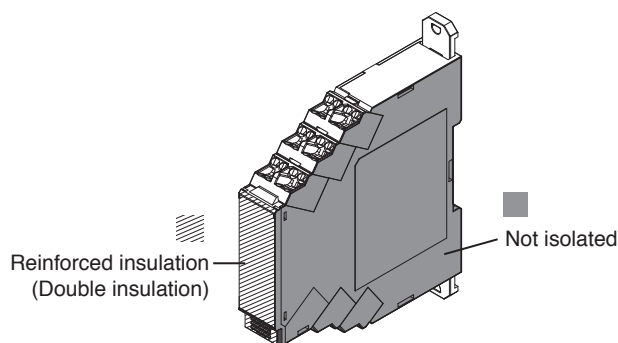

Terms and Conditions of Sale

1. **Offer; Acceptance.** These terms and conditions (these "**Terms**") are deemed part of all quotes, agreements, purchase orders, acknowledgments, price lists, catalogs, manuals, brochures and other documents, whether electronic or in writing, relating to the sale of products or services (collectively, the "**Products**") by Omron Electronics LLC and its subsidiary companies ("**Omron**"). Omron objects to any terms or conditions proposed in Buyer's purchase order or other documents which are inconsistent with, or in addition to, these Terms.
2. **Prices; Payment Terms.** All prices stated are current, subject to change without notice by Omron. Omron reserves the right to increase or decrease prices on any unshipped portions of outstanding orders. Payments for Products are due net 30 days unless otherwise stated in the invoice.
3. **Discounts.** Cash discounts, if any, will apply only on the net amount of invoices sent to Buyer after deducting transportation charges, taxes and duties, and will be allowed only if (i) the invoice is paid according to Omron's payment terms and (ii) Buyer has no past due amounts.
4. **Interest.** Omron, at its option, may charge Buyer 1-1/2% interest per month or the maximum legal rate, whichever is less, on any balance not paid within the stated terms.
5. **Orders.** Omron will accept no order less than \$200 net billing.
6. **Governmental Approvals.** Buyer shall be responsible for, and shall bear all costs involved in, obtaining any government approvals required for the importation or sale of the Products.
7. **Taxes.** All taxes, duties and other governmental charges (other than general real property and income taxes), including any interest or penalties thereon, imposed directly or indirectly on Omron or required to be collected directly or indirectly by Omron for the manufacture, production, sale, delivery, importation, consumption or use of the Products sold hereunder (including customs duties and sales, excise, use, turnover and license taxes) shall be charged to and remitted by Buyer to Omron.
8. **Financial.** If the financial position of Buyer at any time becomes unsatisfactory to Omron, Omron reserves the right to stop shipments or require satisfactory security or payment in advance. If Buyer fails to make payment or otherwise comply with these Terms or any related agreement, Omron may (without liability and in addition to other remedies) cancel any unshipped portion of Products sold hereunder and stop any Products in transit until Buyer pays all amounts, including amounts payable hereunder, whether or not then due, which are owing to it by Buyer. Buyer shall in any event remain liable for all unpaid accounts.
9. **Cancellation; Etc.** Orders are not subject to rescheduling or cancellation unless Buyer indemnifies Omron against all related costs or expenses.
10. **Force Majeure.** Omron shall not be liable for any delay or failure in delivery resulting from causes beyond its control, including earthquakes, fires, floods, strikes or other labor disputes, shortage of labor or materials, accidents to machinery, acts of sabotage, riots, delay in or lack of transportation or the requirements of any government authority.
11. **Shipping; Delivery.** Unless otherwise expressly agreed in writing by Omron:
 - a. Shipments shall be by a carrier selected by Omron; Omron will not drop ship except in "break down" situations.
 - b. Such carrier shall act as the agent of Buyer and delivery to such carrier shall constitute delivery to Buyer;
 - c. All sales and shipments of Products shall be FOB shipping point (unless otherwise stated in writing by Omron), at which point title and risk of loss shall pass from Omron to Buyer; provided that Omron shall retain a security interest in the Products until the full purchase price is paid;
 - d. Delivery and shipping dates are estimates only; and
 - e. Omron will package Products as it deems proper for protection against normal handling and extra charges apply to special conditions.
12. **Claims.** Any claim by Buyer against Omron for shortage or damage to the Products occurring before delivery to the carrier must be presented in writing to Omron within 30 days of receipt of shipment and include the original transportation bill signed by the carrier noting that the carrier received the Products from Omron in the condition claimed.
13. **Warranties.** (a) **Exclusive Warranty.** Omron's exclusive warranty is that the Products will be free from defects in materials and workmanship for a period of twelve months from the date of sale by Omron (or such other period expressed in writing by Omron). Omron disclaims all other warranties, express or implied. (b) **Limitations.** OMRON MAKES NO WARRANTY OR REPRESENTATION, EXPRESS OR IMPLIED, ABOUT NON-INFRINGEMENT, MERCHANTABILITY OR FITNESS FOR A PARTICULAR PURPOSE OF THE PRODUCTS. BUYER ACKNOWLEDGES THAT IT ALONE HAS DETERMINED THAT THE PRODUCTS WILL SUITABLY MEET THE REQUIREMENTS OF THEIR INTENDED USE. Omron further disclaims all warranties and responsibility of any type for claims or expenses based on infringement by the Products or otherwise of any intellectual property right. (c) **Buyer Remedy.** Omron's sole obligation hereunder shall be, at Omron's election, to (i) replace (in the form originally shipped with Buyer responsible for labor charges for removal or replacement thereof) the non-complying Product, (ii) repair the non-complying Product, or (iii) repay or credit Buyer an amount equal to the purchase price of the non-complying Product; provided that in no event shall Omron be responsible for warranty, repair, indemnity or any other claims or expenses regarding the Products unless Omron's analysis confirms that the Products were properly handled, stored, installed and maintained and not subject to contamination, abuse, misuse or inappropriate modification. Return of any Products by Buyer must be approved in writing by Omron before shipment. Omron Companies shall not be liable for the suitability or unsuitability or the results from the use of Products in combination with any electrical or electronic components, circuits, system assemblies or any other materials or substances or environments. Any advice, recommendations or information given orally or in writing, are not to be construed as an amendment or addition to the above warranty. See <http://www.omron247.com> or contact your Omron representative for published information.
14. **Limitation on Liability; Etc.** OMRON COMPANIES SHALL NOT BE LIABLE FOR SPECIAL, INDIRECT, INCIDENTAL, OR CONSEQUENTIAL DAMAGES, LOSS OF PROFITS OR PRODUCTION OR COMMERCIAL LOSS IN ANY WAY CONNECTED WITH THE PRODUCTS, WHETHER SUCH CLAIM IS BASED IN CONTRACT, WARRANTY, NEGLIGENCE OR STRICT LIABILITY. Further, in no event shall liability of Omron Companies exceed the individual price of the Product on which liability is asserted.
15. **Indemnities.** Buyer shall indemnify and hold harmless Omron Companies and their employees from and against all liabilities, losses, claims, costs and expenses (including attorney's fees and expenses) related to any claim, investigation, litigation or proceeding (whether or not Omron is a party) which arises or is alleged to arise from Buyer's acts or omissions under these Terms or in any way with respect to the Products. Without limiting the foregoing, Buyer (at its own expense) shall indemnify and hold harmless Omron and defend or settle any action brought against such Companies to the extent based on a claim that any Product made to Buyer specifications infringed intellectual property rights of another party.
16. **Property; Confidentiality.** Any intellectual property in the Products is the exclusive property of Omron Companies and Buyer shall not attempt to duplicate it in any way without the written permission of Omron. Notwithstanding any charges to Buyer for engineering or tooling, all engineering and tooling shall remain the exclusive property of Omron. All information and materials supplied by Omron to Buyer relating to the Products are confidential and proprietary, and Buyer shall limit distribution thereof to its trusted employees and strictly prevent disclosure to any third party.
17. **Export Controls.** Buyer shall comply with all applicable laws, regulations and licenses regarding (i) export of products or information; (ii) sale of products to "forbidden" or other proscribed persons; and (iii) disclosure to non-citizens of regulated technology or information.
18. **Miscellaneous.** (a) **Waiver.** No failure or delay by Omron in exercising any right and no course of dealing between Buyer and Omron shall operate as a waiver of rights by Omron. (b) **Assignment.** Buyer may not assign its rights hereunder without Omron's written consent. (c) **Law.** These Terms are governed by the law of the jurisdiction of the home office of the Omron company from which Buyer is purchasing the Products (without regard to conflict of law principles). (d) **Amendment.** These Terms constitute the entire agreement between Buyer and Omron relating to the Products, and no provision may be changed or waived unless in writing signed by the parties. (e) **Severability.** If any provision hereof is rendered ineffective or invalid, such provision shall not invalidate any other provision. (f) **Setoff.** Buyer shall have no right to set off any amounts against the amount owing in respect of this invoice. (g) **Definitions.** As used herein, "including" means "including without limitation"; and "Omron Companies" (or similar words) mean Omron Corporation and any direct or indirect subsidiary or affiliate thereof.

Certain Precautions on Specifications and Use

1. **Suitability of Use.** Omron Companies shall not be responsible for conformity with any standards, codes or regulations which apply to the combination of the Product in the Buyer's application or use of the Product. At Buyer's request, Omron will provide applicable third party certification documents identifying ratings and limitations of use which apply to the Product. This information by itself is not sufficient for a complete determination of the suitability of the Product in combination with the end product, machine, system, or other application or use. Buyer shall be solely responsible for determining appropriateness of the particular Product with respect to Buyer's application, product or system. Buyer shall take application responsibility in all cases but the following is a non-exhaustive list of applications for which particular attention must be given: (i) Outdoor use, uses involving potential chemical contamination or electrical interference, or conditions or uses not described in this document. (ii) Use in consumer products or any use in significant quantities. (iii) Energy control systems, combustion systems, railroad systems, aviation systems, medical equipment, amusement machines, vehicles, safety equipment, and installations subject to separate industry or government regulations. (iv) Systems, machines and equipment that could present a risk to life or property. Please know and observe all prohibitions of use applicable to this Product. NEVER USE THE PRODUCT FOR AN APPLICATION INVOLVING SERIOUS RISK TO LIFE OR PROPERTY OR IN LARGE QUANTITIES WITHOUT ENSURING THAT THE SYSTEM AS A WHOLE HAS BEEN DESIGNED TO ADDRESS THE RISKS, AND THAT THE OMRON'S PRODUCT IS PROPERLY RATED AND INSTALLED FOR THE INTENDED USE WITHIN THE OVERALL EQUIPMENT OR SYSTEM.
2. **Programmable Products.** Omron Companies shall not be responsible for the user's programming of a programmable Product, or any consequence thereof.
3. **Performance Data.** Data presented in Omron Company websites, catalogs and other materials is provided as a guide for the user in determining suitability and does not constitute a warranty. It may represent the result of Omron's test conditions, and the user must correlate it to actual application requirements. Actual performance is subject to the Omron's Warranty and Limitations of Liability.
4. **Change in Specifications.** Product specifications and accessories may be changed at any time based on improvements and other reasons. It is our practice to change part numbers when published ratings or features are changed, or when significant construction changes are made. However, some specifications of the Product may be changed without any notice. When in doubt, special part numbers may be assigned to fix or establish key specifications for your application. Please consult with your Omron's representative at any time to confirm actual specifications of purchased Product.
5. **Errors and Omissions.** Information presented by Omron Companies has been checked and is believed to be accurate; however, no responsibility is assumed for clerical, typographical or proofreading errors or omissions.

OMRON AUTOMATION AND SAFETY • THE AMERICAS HEADQUARTERS • Chicago, IL USA • 847.843.7900 • 800.556.6766 • www.omron247.com

OMRON CANADA, INC. • HEAD OFFICE

Toronto, ON, Canada • 416.286.6465 • 866.986.6766 • www.omron247.com

OMRON ELECTRONICS DE MEXICO • HEAD OFFICE

México DF • 52.55.59.01.43.00 • 01-800-226-6766 • mela@omron.com

OMRON ELECTRONICS DE MEXICO • SALES OFFICE

Apodaca, N.L. • 52.81.11.56.99.20 • 01-800-226-6766 • mela@omron.com

OMRON ELETRÔNICA DO BRASIL LTDA • HEAD OFFICE

São Paulo, SP, Brasil • 55.11.2101.6300 • www.omron.com.br

OMRON ARGENTINA • SALES OFFICE

Cono Sur • 54.11.4783.5300

OMRON CHILE • SALES OFFICE

Santiago • 56.9.9917.3920

OTHER OMRON LATIN AMERICA SALES

54.11.4783.5300

OMRON EUROPE B.V. • Wegalaan 67-69, NL-2132 JD, Hoofddorp, The Netherlands. • +31 (0) 23 568 13 00 • www.industrial.omron.eu

Authorized Distributor:

Automation Control Systems

- Machine Automation Controllers (MAC) • Programmable Controllers (PLC)
- Operator interfaces (HMI) • Distributed I/O • Software

Drives & Motion Controls

- Servo & AC Drives • Motion Controllers & Encoders

Temperature & Process Controllers

- Single and Multi-loop Controllers

Sensors & Vision

- Proximity Sensors • Photoelectric Sensors • Fiber-Optic Sensors
- Amplified Photomicrosensors • Measurement Sensors
- Ultrasonic Sensors • Vision Sensors

Industrial Components

- RFID/Code Readers • Relays • Pushbuttons & Indicators
- Limit and Basic Switches • Timers • Counters • Metering Devices
- Power Supplies

Safety

- Laser Scanners • Safety Mats • Edges and Bumpers • Programmable Safety Controllers • Light Curtains • Safety Relays • Safety Interlock Switches



**Стандарт
Электрон
Связь**

Мы молодая и активно развивающаяся компания в области поставок электронных компонентов. Мы поставляем электронные компоненты отечественного и импортного производства напрямую от производителей и с крупнейших складов мира.

Благодаря сотрудничеству с мировыми поставщиками мы осуществляем комплексные и плановые поставки широчайшего спектра электронных компонентов.

Собственная эффективная логистика и склад в обеспечивает надежную поставку продукции в точно указанные сроки по всей России.

Мы осуществляем техническую поддержку нашим клиентам и предпродажную проверку качества продукции. На все поставляемые продукты мы предоставляем гарантию .

Осуществляем поставки продукции под контролем ВП МО РФ на предприятия военно-промышленного комплекса России , а также работаем в рамках 275 ФЗ с открытием отдельных счетов в уполномоченном банке. Система менеджмента качества компании соответствует требованиям ГОСТ ISO 9001.

Минимальные сроки поставки, гибкие цены, неограниченный ассортимент и индивидуальный подход к клиентам являются основой для выстраивания долгосрочного и эффективного сотрудничества с предприятиями радиоэлектронной промышленности, предприятиями ВПК и научно-исследовательскими институтами России.

С нами вы становитесь еще успешнее!

Наши контакты:

Телефон: +7 812 627 14 35

Электронная почта: sales@st-electron.ru

Адрес: 198099, Санкт-Петербург,
Промышленная ул, дом № 19, литера Н,
помещение 100-Н Офис 331