

VERONICA-SQ-MINI-O

~15° + 50° oval beam

TECHNICAL SPECIFICATIONS:

Dimensions	13.9 mm
Height	8.9 mm
Fastening	tape, pin
ROHS compliant	yes 

MATERIAL SPECIFICATIONS:

Component	Type	Material	Colour	Finish
VERONICA-SQ-MINI-O	Single lens	PMMA	clear	
VERONICA-SQ-MINI-TAPE	Tape	Acrylic foam	clear	



ORDERING INFORMATION:

Component	Type	Qty in box	MOQ	MPQ	Box weight (kg)
CA14602_VERONICA-SQ-MINI-O » Box size: 480 x 280 x 300 mm	Single lens	5544	252	252	7.8

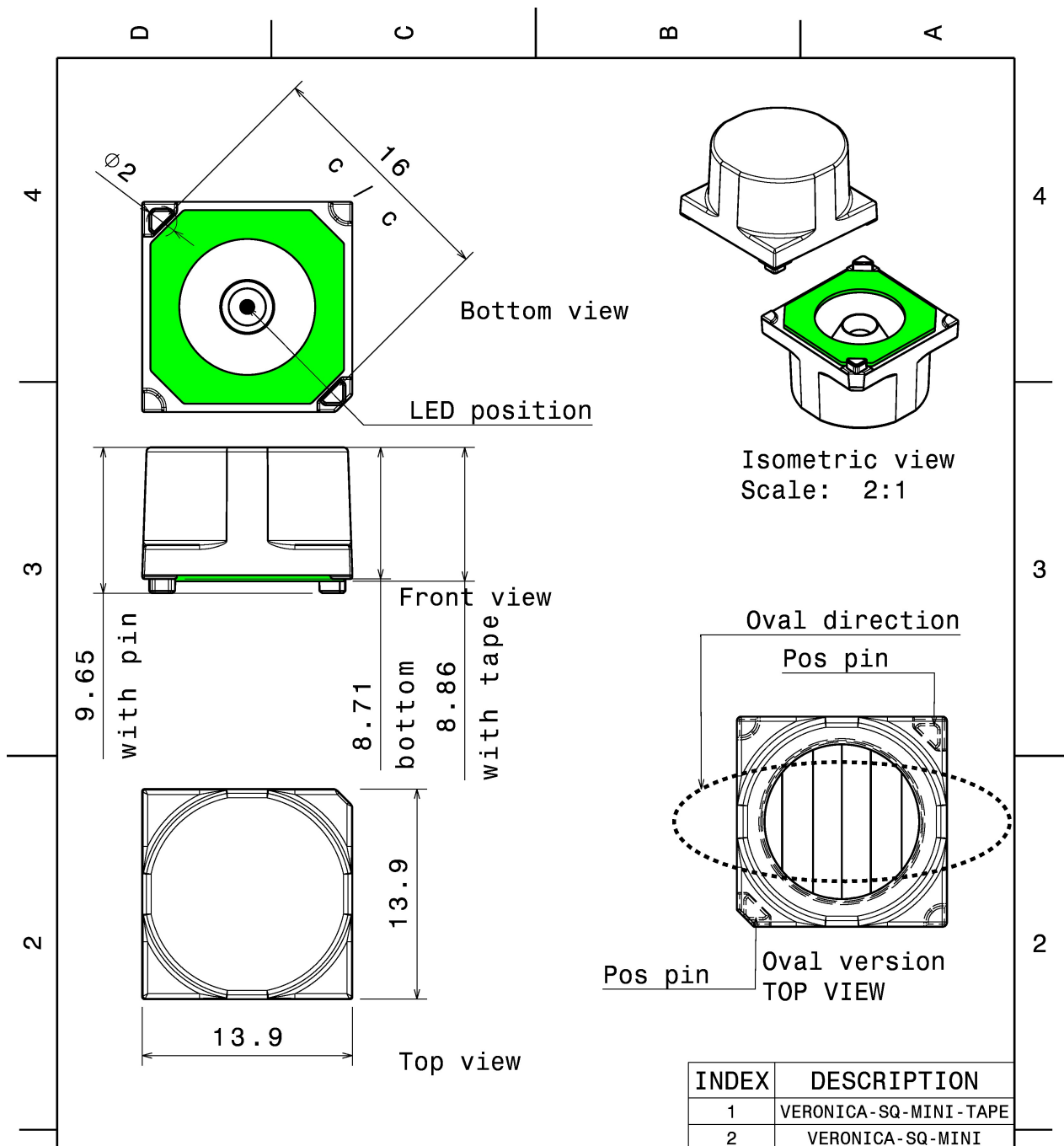

Tolerances if not otherwise shown
According to DIN ISO 2768-1
Linear measures:
up to 30mm class M, otherwise class C
According to DIN ISO 2768-2
Form and position: class L

LEDiL Ledil Oy
Joensuunkatu 13
FIN 24100 SALO
Finland

THIRD ANGLE PROJECTION:

DRAWING TITLE
VERONICA-SQ-MINI

This drawing is the property of LEDiL Oy. It may not be reproduced, copied or communicated without a written agreement with LEDiL Oy.

SIZE	PART NUMBER
A4	-

SCALE	3:1	WEIGHT		SHEET	1/1
-------	-----	--------	--	-------	-----

PHOTOMETRIC DATA (MEASURED):

CREE

LED XD16
 FWHM 41.0 + 18.0°
 Efficiency 89 %
 Peak intensity 2.2 cd/lm
 LEDs/each optic 1
 Light colour White
 Required components:

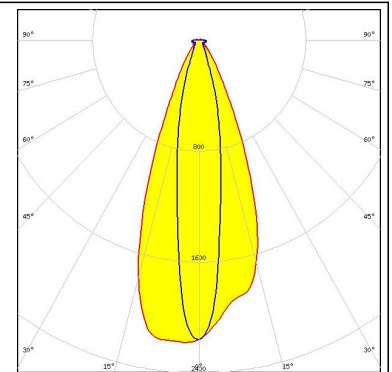

CREE

LED XP-E2
 FWHM 42.0 + 14.0°
 Efficiency 92 %
 Peak intensity 3.8 cd/lm
 LEDs/each optic 1
 Light colour White
 Required components:

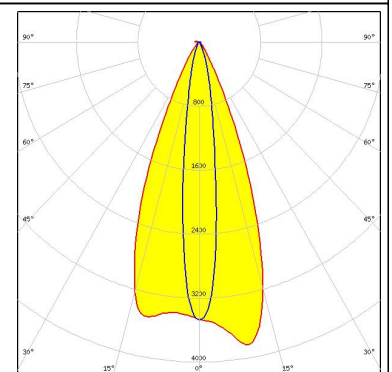
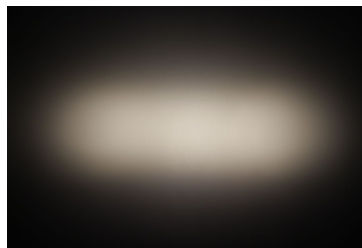

CREE

LED XP-G2
 FWHM 45.0 + 20.0°
 Efficiency 92 %
 Peak intensity 2.3 cd/lm
 LEDs/each optic 1
 Light colour White
 Required components:

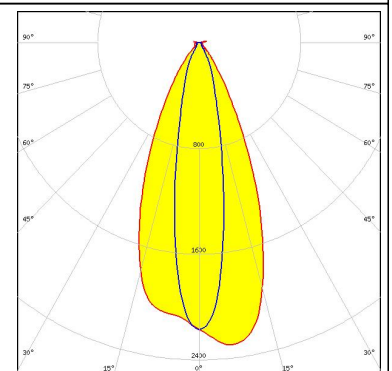
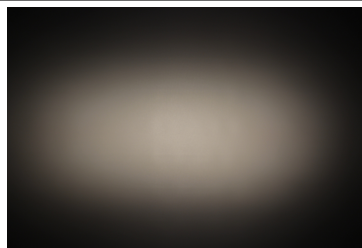

CREE

LED XP-G3
 FWHM 41.0 + 24.0°
 Efficiency 92 %
 Peak intensity 1.8 cd/lm
 LEDs/each optic 1
 Light colour White
 Required components:

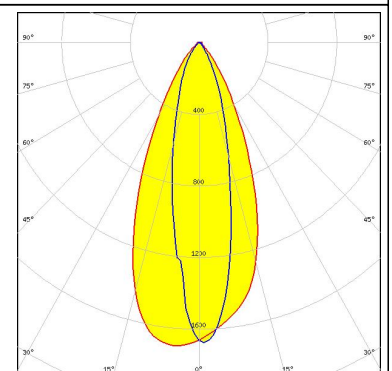
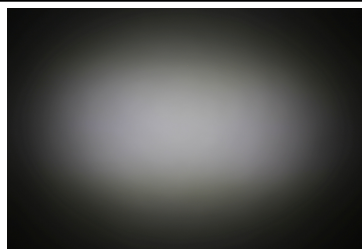

PHOTOMETRIC DATA (MEASURED):

LUMILEDS

LED LUXEON Rebel
 FWHM 42.0 + 20.0°
 Efficiency 90 %
 Peak intensity 2.1 cd/lm
 LEDs/each optic 1
 Light colour White
 Required components:

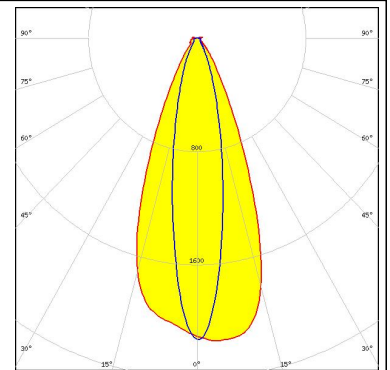

LUMILEDS

LED LUXEON Rebel ES
 FWHM 50.0 + 23.0°
 Efficiency 80 %
 Peak intensity 2.1 cd/lm
 LEDs/each optic 1
 Light colour White
 Required components:

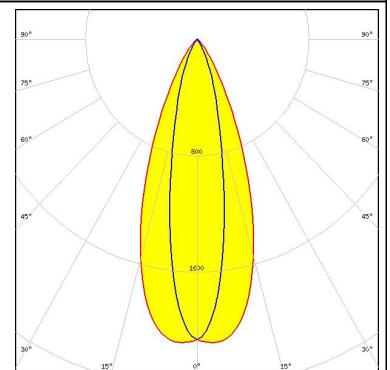
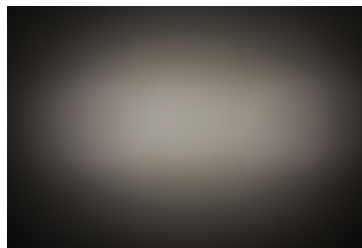

LUMILEDS

LED LUXEON TX
 FWHM 42.0 + 22.0°
 Efficiency 90 %
 Peak intensity 2.1 cd/lm
 LEDs/each optic 1
 Light colour White
 Required components:

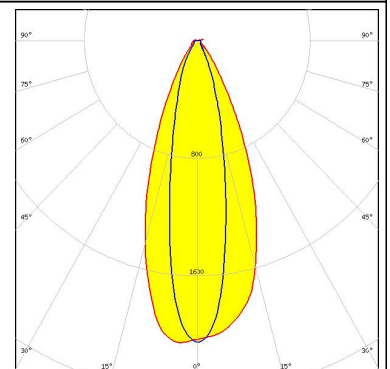
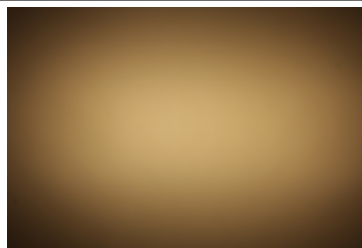

NICHIA

LED NCSxE17A
 FWHM 40.0 + 20.0°
 Efficiency 89 %
 Peak intensity 2.1 cd/lm
 LEDs/each optic 1
 Light colour White
 Required components:

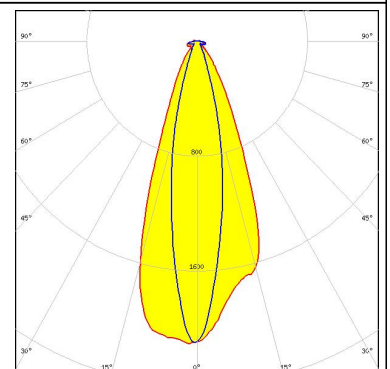
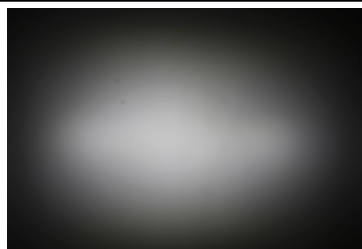

PHOTOMETRIC DATA (MEASURED):



LED NVSxx19B/NVSxx19C
 FWHM 41.0 + 23.0°
 Efficiency 90 %
 Peak intensity 1.9 cd/lm
 LEDs/each optic 1
 Light colour White
 Required components:

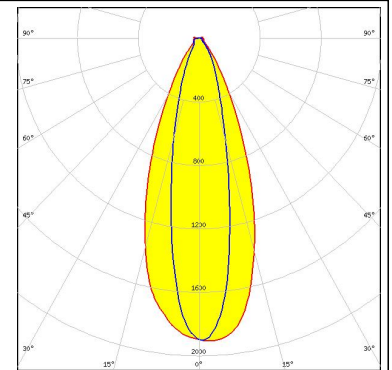

LED Duris S5 (2 chip)
 FWHM 76.0 + 22.0°
 Efficiency 74 %
 Peak intensity 1.6 cd/lm
 LEDs/each optic 1
 Light colour White
 Required components:

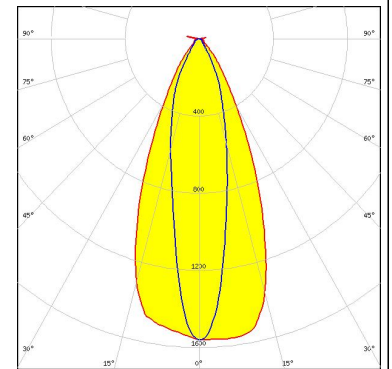
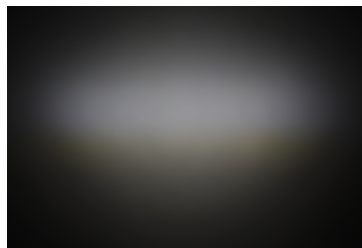

LED OSLON Square EC
 FWHM 42.0 + 20.0°
 Efficiency 89 %
 Peak intensity 2.2 cd/lm
 LEDs/each optic 1
 Light colour White
 Required components:

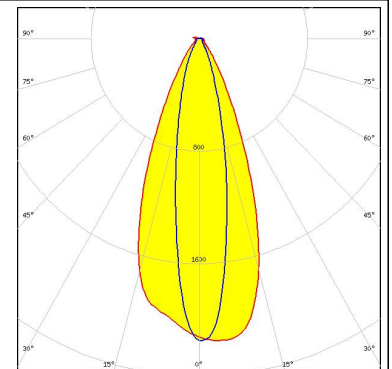
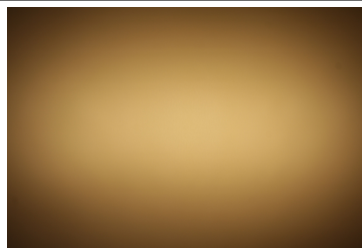

LED SFH 4170S
 FWHM 40.0 + 12.0°
 Efficiency %
 LEDs/each optic 1
 Light colour IR
 Required components:

PHOTOMETRIC DATA (MEASURED):

OSRAM

Opto Semiconductors

LED SFH 4180S
 FWHM 38.0 + 11.0°
 Efficiency %
 LEDs/each optic 1
 Light colour IR
 Required components:

SAMSUNG

LED LH181A
 FWHM 42.0 + 22.0°
 Efficiency 88 %
 Peak intensity 1.5 cd/lm
 LEDs/each optic 1
 Light colour White
 Required components:

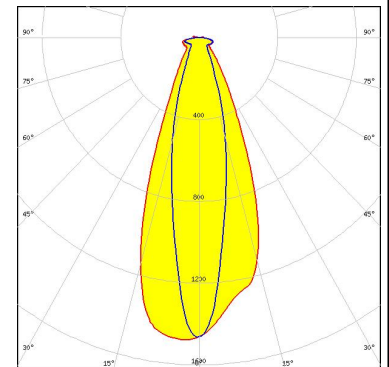
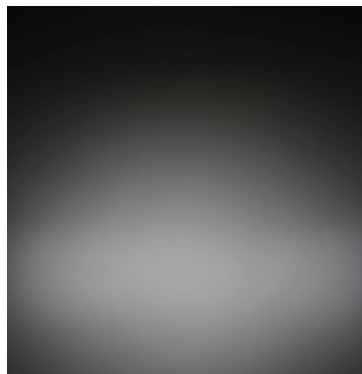

SAMSUNG

LED LH181B
 FWHM 22.0 + 41.0°
 Efficiency 91 %
 Peak intensity 1.8 cd/lm
 LEDs/each optic 1
 Light colour White
 Required components:

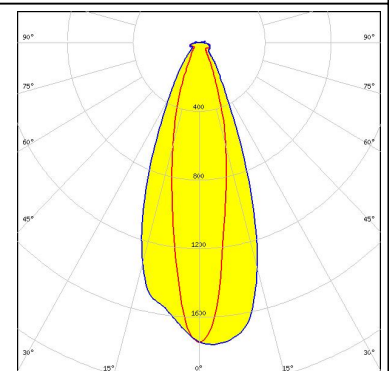
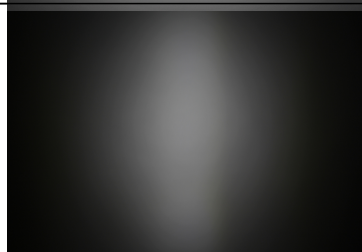

SEOUL SEMICONDUCTOR

LED Z8Y22P
 FWHM 46.0 + 23.0°
 Efficiency 90 %
 Peak intensity 1.5 cd/lm
 LEDs/each optic 1
 Light colour White
 Required components:

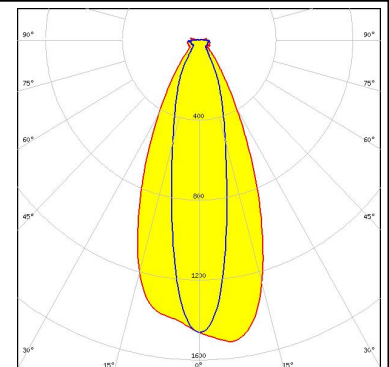
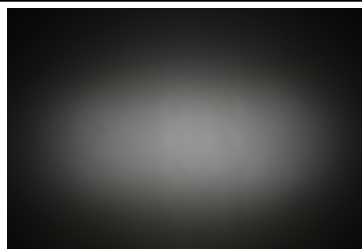

PHOTOMETRIC DATA (SIMULATED):



LED XP-G2 HE
 FWHM 50.0 + 26.0°
 Efficiency 90 %
 Peak intensity 1.6 cd/lm
 LEDs/each optic 1
 Light colour White
 Required components:

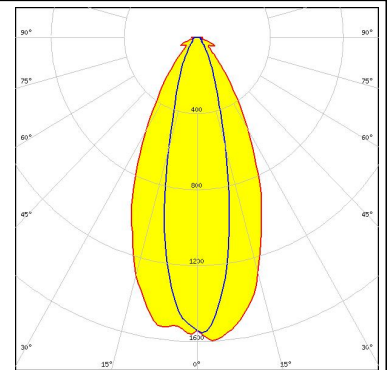

LED XQ-E HD
 FWHM 54.0 + 16.0°
 Efficiency 90 %
 Peak intensity 2.7 cd/lm
 LEDs/each optic 1
 Light colour White
 Required components:



LED LUXEON 5050 Round LES
 FWHM 54.0 + 36.0°
 Efficiency 86 %
 Peak intensity 0.8 cd/lm
 LEDs/each optic 1
 Light colour White
 Required components:

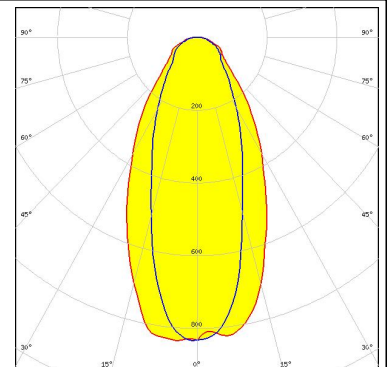

LED LUXEON C
 FWHM 53.0 + 17.0°
 Efficiency 87 %
 Peak intensity 2.6 cd/lm
 LEDs/each optic 1
 Light colour White
 Required components:

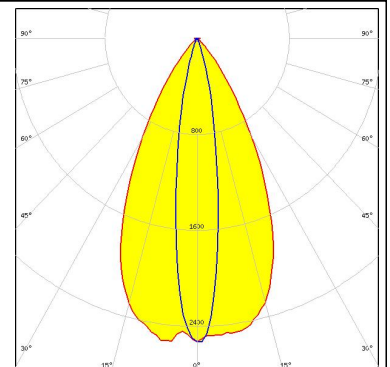

PHOTOMETRIC DATA (SIMULATED):

LUMILEDS

LED LUXEON CZ
 FWHM 56.0 + 13.0°
 Efficiency 91 %
 Peak intensity 3.3 cd/lm
 LEDs/each optic 1
 Light colour PC Amber
 Required components:

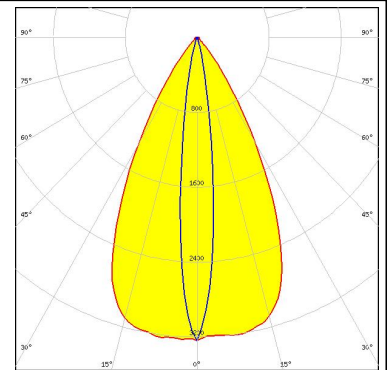

LUMILEDS

LED LUXEON CZ
 FWHM 54.0 + 12.0°
 Efficiency 91 %
 Peak intensity 3.5 cd/lm
 LEDs/each optic 1
 Light colour Red
 Required components:

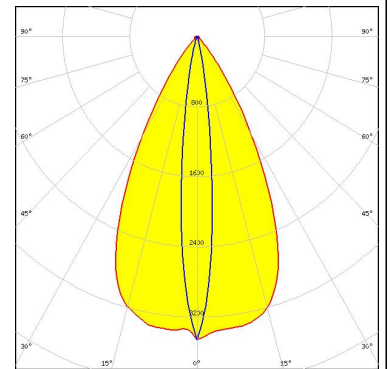

LUMILEDS

LED LUXEON Z ES
 FWHM 53.0 + 16.0°
 Efficiency 92 %
 Peak intensity 2.6 cd/lm
 LEDs/each optic 1
 Light colour White
 Required components:

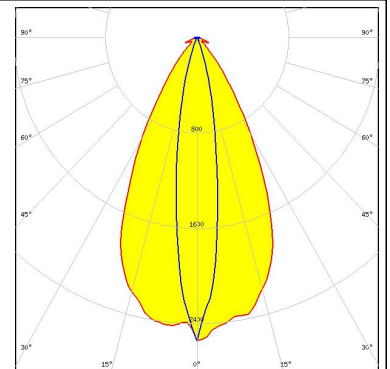

OSRAM

OSRAM Opto Semiconductors
 LED OSCONIQ P 3737 (2W version)
 FWHM 49.0 + 22.0°
 Efficiency 83 %
 Peak intensity 1.9 cd/lm
 LEDs/each optic 1
 Light colour White
 Required components:

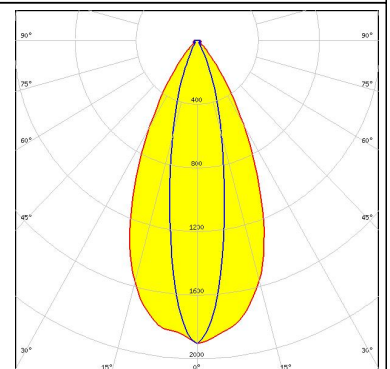

PHOTOMETRIC DATA (SIMULATED):

OSRAM Opto Semiconductors

LED OSCONIQ P 3737 (3W version)
 FWHM 24.0 + 48.0°
 Efficiency 84 %
 Peak intensity 1.3 cd/lm
 LEDs/each optic 1
 Light colour White
 Required components:

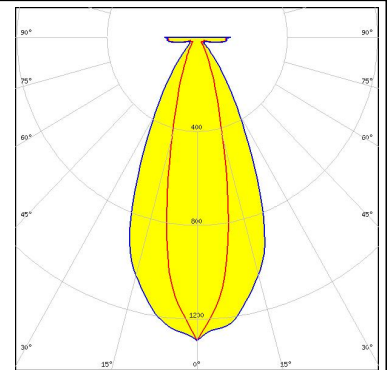

OSRAM Opto Semiconductors

LED OSLON Square CSSRM2/CSSRM3
 FWHM 48.0 + 20.0°
 Efficiency 81 %
 Peak intensity 2 cd/lm
 LEDs/each optic 1
 Light colour White
 Required components:

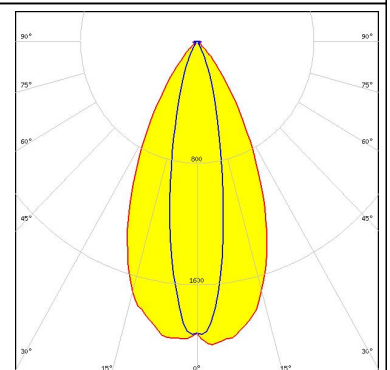

OSRAM Opto Semiconductors

LED OSLON SSL 150
 FWHM 55.0 + 16.0°
 Efficiency 89 %
 Peak intensity 2.6 cd/lm
 LEDs/each optic 1
 Light colour Blue
 Required components:

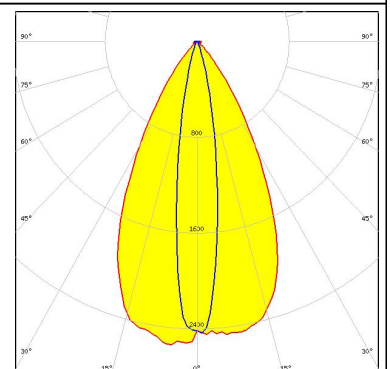

OSRAM Opto Semiconductors

LED OSLON SSL 150
 FWHM 54.0 + 15.0°
 Efficiency 90 %
 Peak intensity 2.8 cd/lm
 LEDs/each optic 1
 Light colour Green
 Required components:

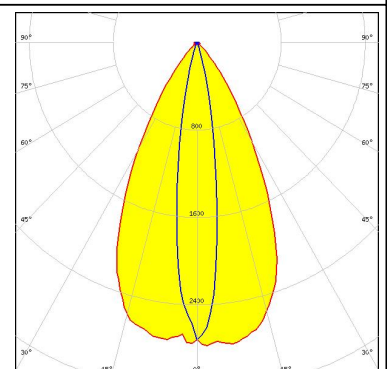

PHOTOMETRIC DATA (SIMULATED):

OSRAM

Opto Semiconductors

LED OSOLON SSL 150
 FWHM 53.0 + 16.0°
 Efficiency 90 %
 Peak intensity 2.8 cd/lm
 LEDs/each optic 1
 Light colour Red
 Required components:

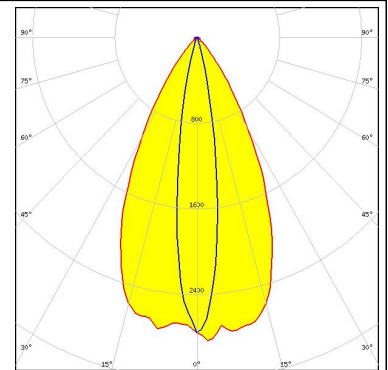

SAMSUNG

LED LH351B
 FWHM 49.0 + 24.0°
 Efficiency 84 %
 Peak intensity 1.8 cd/lm
 LEDs/each optic 1
 Light colour White
 Required components:

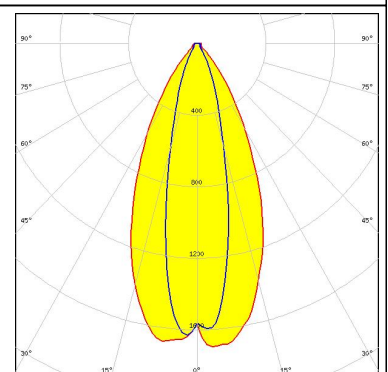

SEOUL SEMICONDUCTOR

LED Z5M1/Z5M2
 FWHM 50.0 + 22.0°
 Efficiency 88 %
 Peak intensity 2 cd/lm
 LEDs/each optic 1
 Light colour White
 Required components:

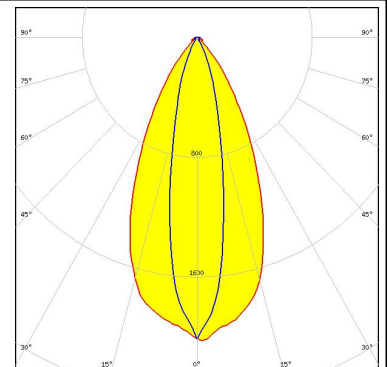

SEOUL SEMICONDUCTOR

LED Z8Y19
 FWHM 22.0 + 52.0°
 Efficiency 87 %
 Peak intensity 1.4 cd/lm
 LEDs/each optic 1
 Light colour White
 Required components:

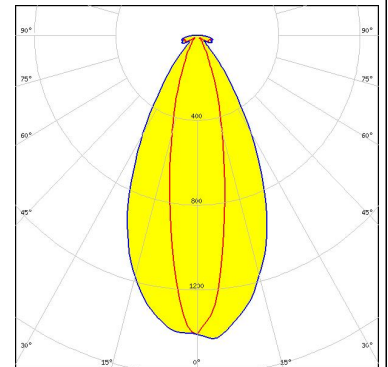

PHOTOMETRIC DATA (SIMULATED):



GENERAL INFORMATION:

NOTE: The typical beam angle will be changed by different color, chip size and chip position tolerance. The typical total beam angle is the full angle measured where the luminous intensity is half of the peak value.

MATERIALS:

As part of our continuous research and improvement processes, and to ensure the best possible quality and availability of our products, LEDiL reserves the right to change material grades without notice.

PRODUCT DATA USER AGREEMENT AND DISCLAIMER:

The measured data in the provided downloadable LEDiL Product Datasheets and Mechanical 2D-Drawings is rounded and provided as reference for planning. LEDiL Oy's optical specifications have been verified by conducting performance testing of the products in accordance with the company's quality system. The reported data are averaged results of multiple measurements with typical variation. LEDiL Oy reserves the right to without prior notification make changes and improvements to its products.

LEDiL Oy assumes neither warranty, nor guarantee nor any other liability of any kind for the contents and correctness of the provided data. The provided data has been generated with highest diligence but the provided data may in reality not represent the complete possible variation range of all intrinsic parameters. Therefore, in certain cases a deviation from the provided data could occur.

LEDiL Oy reserves the right to undertake technical changes of its products without further notification which could lead to changes in the provided data. LEDiL Oy assumes no liability of any kind for the possible deviation from any provided data or any other damage resulting from the usage of the provided data.

The user agrees to this disclaimer and user agreement with the download or usage of the provided files.

LEDiL Oy

Joensuunkatu 13
FI-24240 SALO
Finland

LEDiL Inc.

228 West Page Street
Suite D
Sycamore IL 60178
USA

Local sales and technical support

[www.ledil.com/
where_to_buy](http://www.ledil.com/where_to_buy)

Shipping locations

Salo, Finland
Hong Kong, China

Distribution Partners

[www.ledil.com/
where_to_buy](http://www.ledil.com/where_to_buy)



**Стандарт
Электрон
Связь**

Мы молодая и активно развивающаяся компания в области поставок электронных компонентов. Мы поставляем электронные компоненты отечественного и импортного производства напрямую от производителей и с крупнейших складов мира.

Благодаря сотрудничеству с мировыми поставщиками мы осуществляем комплексные и плановые поставки широчайшего спектра электронных компонентов.

Собственная эффективная логистика и склад в обеспечивает надежную поставку продукции в точно указанные сроки по всей России.

Мы осуществляем техническую поддержку нашим клиентам и предпродажную проверку качества продукции. На все поставляемые продукты мы предоставляем гарантию .

Осуществляем поставки продукции под контролем ВП МО РФ на предприятия военно-промышленного комплекса России , а также работаем в рамках 275 ФЗ с открытием отдельных счетов в уполномоченном банке. Система менеджмента качества компании соответствует требованиям ГОСТ ISO 9001.

Минимальные сроки поставки, гибкие цены, неограниченный ассортимент и индивидуальный подход к клиентам являются основой для выстраивания долгосрочного и эффективного сотрудничества с предприятиями радиоэлектронной промышленности, предприятиями ВПК и научно-исследовательскими институтами России.

С нами вы становитесь еще успешнее!

Наши контакты:

Телефон: +7 812 627 14 35

Электронная почта: sales@st-electron.ru

Адрес: 198099, Санкт-Петербург,
Промышленная ул, дом № 19, литера Н,
помещение 100-Н Офис 331