



Micro Commercial Components



Micro Commercial Components
 20736 Marilla Street Chatsworth
 CA 91311
 Phone: (818) 701-4933
 Fax: (818) 701-4939

UMT1N

Features

- Halogen free available upon request by adding suffix "-HF"
- Two 2SA1037AK chips in a package
- Mounting possible with SOT-363 automatic mounting machines.
- Transistor elements are independent, eliminating interference.
- Lead Free Finish/RoHS Compliant ("P" Suffix designates RoHS Compliant. See ordering information)
- Epoxy meets UL 94 V-0 flammability rating
- Moisture Sensitivity Level 1

Dual Transistors

Mechanical Data

- Case: SOT-363, Molded Plastic
- Polarity: See Diagram

Maximum Ratings @ 25°C Unless Otherwise Specified

Symbol	Parameter	Value	Units
OFF CHARACTERISTICS			
$V_{(BR)CEO}$	Collector-Emitter Breakdown Voltage	-50	Vdc
$V_{(BR)CBO}$	Collector-Base Breakdown Voltage	-60	Vdc
$V_{(BR)EBO}$	Collector-Emitter Breakdown Voltage	-6.0	Vdc
I_c	Collector Current	-150	mAdc
P_d	Power Dissipation	150	mW
T_J, T_{STG}	Operating & Storage Temperature	-55~+150	°C

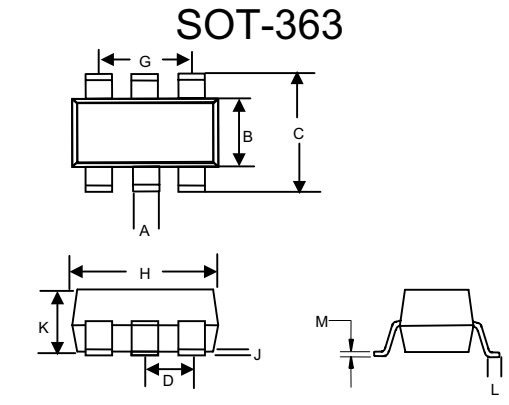

DIM	DIMENSIONS				NOTE
	INCHES		MM		
A	.006	.014	0.15	0.35	
B	.045	.053	1.15	1.35	
C	.085	.096	2.15	2.45	
D	.026		0.65Nominal		
G	.047	.055	1.20	1.40	
H	.071	.087	1.80	2.20	
J	---	.004	---	0.10	
K	.035	.043	0.90	1.10	
L	.010	.018	0.26	0.46	
M	.003	.006	0.08	0.15	

MARKING:T1

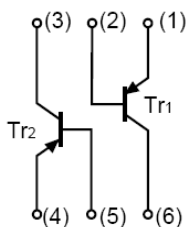

UMT1N



Micro Commercial Components TM

ELECTRICAL CHARACTERISTICS (Tamb=25°C unless otherwise specified)

Parameter	Symbol	Test conditions	MIN	TYP	MAX	UNIT
Collector-base breakdown voltage	$V_{(BR)CBO}$	$I_C = -50\mu A, I_E = 0$	-60			V
Collector-emitter breakdown Voltage	$V_{(BR)CEO}$	$I_C = -1mA, I_B = 0$	-50			V
Emitter-base breakdown voltage	$V_{(BR)EBO}$	$I_E = -50\mu A, I_C = 0$	-6			V
Collector cut-off current	I_{CBO}	$V_{CB} = -60V, I_E = 0$			-0.1	μA
Emitter cut-off current	I_{EBO}	$V_{EB} = -6V, I_C = 0$			-0.1	μA
DC current gain	h_{FE}	$V_{CE} = -6V, I_C = -1mA$	120		560	
Collector-emitter saturation voltage	$V_{CE(sat)}$	$I_C = -50mA, I_B = -5mA$			-0.5	V
Transition frequency	f_T	$V_{CE} = -12V, I_E = 2mA,$ $f = 100MHz$		140		MHz
Output capacitance	C_{ob}	$V_{CB} = -12V, I_E = 0, f = 1MHz$			5	pF

UMT1N



Micro Commercial Components

Typical Characteristics

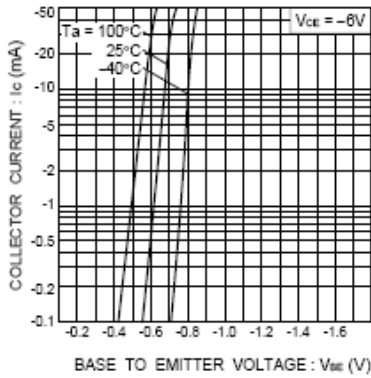

Fig.1 Grounded emitter propagation characteristics

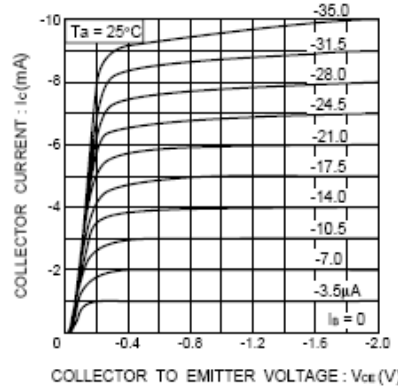

Fig.2 Grounded emitter output characteristics (I)

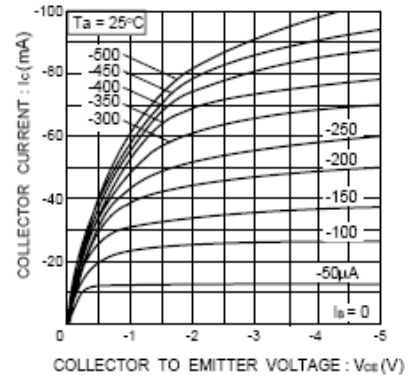

Fig.3 Grounded emitter output characteristics (II)

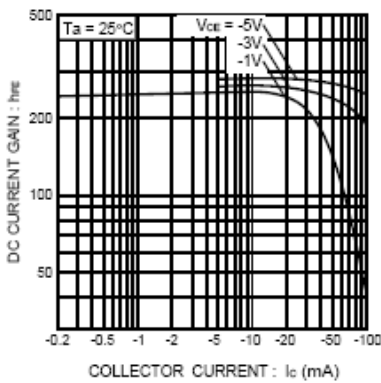

Fig.4 DC current gain vs. collector current (I)

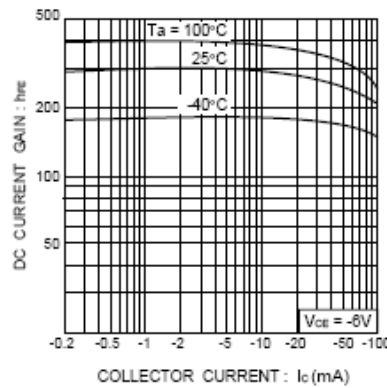

Fig.5 DC current gain vs. collector current (II)

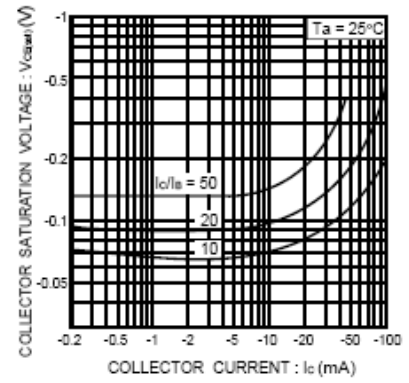

Fig.6 Collector-emitter saturation voltage vs. collector current (I)

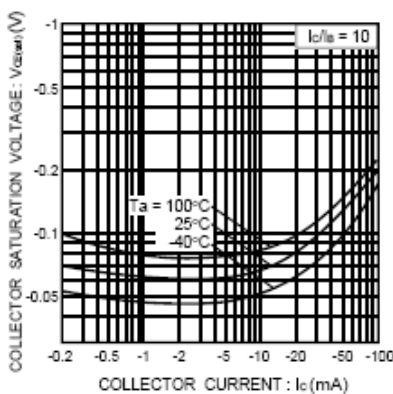

Fig.7 Collector-emitter saturation voltage vs. collector current (II)

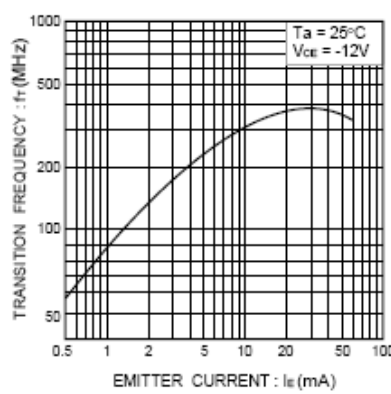

Fig.8 Gain bandwidth product vs. emitter current

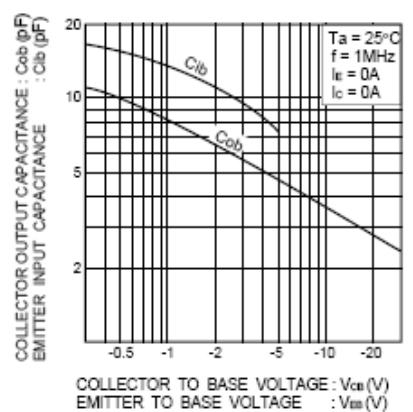

Fig.9 Collector output capacitance vs. collector-base voltage
Emitter input capacitance vs. emitter-base voltage



Micro Commercial Components

Ordering Information :

Device	Packing
Part Number-TP	Tape&Reel; 3Kpcs/Reel

Note : Adding "-HF" suffix for halogen free, eg. Part Number-TP-HF

*****IMPORTANT NOTICE*****

Micro Commercial Components Corp. reserves the right to make changes without further notice to any product herein to make corrections, modifications, enhancements, improvements, or other changes. **Micro Commercial Components Corp.** does not assume any liability arising out of the application or use of any product described herein; neither does it convey any license under its patent rights, nor the rights of others. The user of products in such applications shall assume all risks of such use and will agree to hold **Micro Commercial Components Corp.** and all the companies whose products are represented on our website, harmless against all damages.

*****LIFE SUPPORT*****

MCC's products are not authorized for use as critical components in life support devices or systems without the express written approval of Micro Commercial Components Corporation.

*****CUSTOMER AWARENESS*****

Counterfeiting of semiconductor parts is a growing problem in the industry. Micro Commercial Components (MCC) is taking strong measures to protect ourselves and our customers from the proliferation of counterfeit parts. MCC strongly encourages customers to purchase MCC parts either directly from MCC or from Authorized MCC Distributors who are listed by country on our web page cited below. Products customers buy either from MCC directly or from Authorized MCC Distributors are genuine parts, have full traceability, meet MCC's quality standards for handling and storage. **MCC will not provide any warranty coverage or other assistance for parts bought from Unauthorized Sources.** MCC is committed to combat this global problem and encourage our customers to do their part in stopping this practice by buying direct or from authorized distributors.

www.mccsemi.com



Стандарт Электрон Связь

Мы молодая и активно развивающаяся компания в области поставок электронных компонентов. Мы поставляем электронные компоненты отечественного и импортного производства напрямую от производителей и с крупнейших складов мира.

Благодаря сотрудничеству с мировыми поставщиками мы осуществляем комплексные и плановые поставки широчайшего спектра электронных компонентов.

Собственная эффективная логистика и склад в обеспечивает надежную поставку продукции в точно указанные сроки по всей России.

Мы осуществляем техническую поддержку нашим клиентам и предпродажную проверку качества продукции. На все поставляемые продукты мы предоставляем гарантию .

Осуществляем поставки продукции под контролем ВП МО РФ на предприятия военно-промышленного комплекса России , а также работаем в рамках 275 ФЗ с открытием отдельных счетов в уполномоченном банке. Система менеджмента качества компании соответствует требованиям ГОСТ ISO 9001.

Минимальные сроки поставки, гибкие цены, неограниченный ассортимент и индивидуальный подход к клиентам являются основой для выстраивания долгосрочного и эффективного сотрудничества с предприятиями радиоэлектронной промышленности, предприятиями ВПК и научно-исследовательскими институтами России.

С нами вы становитесь еще успешнее!

Наши контакты:

Телефон: +7 812 627 14 35

Электронная почта: sales@st-electron.ru

Адрес: 198099, Санкт-Петербург,
Промышленная ул, дом № 19, литера Н,
помещение 100-Н Офис 331