

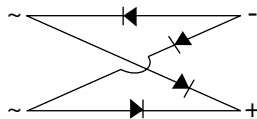

## Low Profile Miniature Glass Passivated Single-Phase Surface Mount Bridge Rectifiers

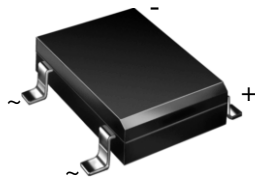

Case Style Low Pro le DFS

### FEATURES

- Low profile: typical height of 2.5 mm
- UL recognition, file number E54214
- Ideal for automated placement
- High surge current capability
- Meets MSL level 1, per J-STD-020, LF maximum peak of 250 °C
- Solder dip 260 °C, 40 s
- Compliant to RoHS directive 2002/95/EC and in accordance to WEEE 2002/96/EC

RoHS  
COMPLIANT

### TYPICAL APPLICATIONS

General purpose use in ac-to-dc bridge full wave rectification for SMPS, lighting ballaster, adapter, battery charger, home appliances, office equipment, and telecommunication applications.

### MECHANICAL DATA

**Case:** Low profile DFS

Epoxy meets UL 94 V-0 flammability rating

**Terminals:** Matte tin plated leads, solderable per J-STD-002 and JESD22-B102

E3 suffix for consumer grade, meets JESD 201 class 1A whisker test

**Polarity:** As marked on body

PRIMARY CHARACTERISTICS	
$I_{F(AV)}$	1.5 A
$V_{RRM}$	50 V to 1000 V
$I_{FSM}$	50 A
$I_R$	5 $\mu$ A
$V_F$	1.1 V
$T_J$ max.	150 °C

MAXIMUM RATINGS ( $T_A = 25$ °C unless otherwise noted)									
PARAMETER	SYMBOL	DFL 15005S	DFL 1501S	DFL 1502S	DFL 1504S	DFL 1506S	DFL 1508S	DFL 1510S	UNIT
Maximum repetitive peak reverse voltage	$V_{RRM}$	50	100	200	400	600	800	1000	V
Maximum RMS voltage	$V_{RMS}$	35	70	140	280	420	560	700	V
Maximum DC blocking voltage	$V_{DC}$	50	100	200	400	600	800	1000	V
Maximum average forward output rectified current at $T_A = 40$ °C	$I_{F(AV)}$ <sup>(1)</sup>	1.5							A
Peak forward surge current single half sine-wave superimposed on rated load	$I_{FSM}$	50							A
Rating for fusing ( $t < 8.3$ ms)	$I^2t$	10							A <sup>2</sup> s
Operating junction and storage temperature range	$T_J, T_{STG}$	- 55 to + 150							°C

#### Note

<sup>(1)</sup> Units mounted on P.C.B. with 0.51" x 0.51" (13 mm x 13 mm) copper pads

# DFL15005S thru DFL1510S

Vishay General Semiconductor



ELECTRICAL CHARACTERISTICS (T <sub>A</sub> = 25 °C unless otherwise noted)											
PARAMETER	TEST CONDITIONS	SYMBOL	DFL 15005S	DFL 1501S	DFL 1502S	DFL 1504S	DFL 1506S	DFL 1508S	DFL 1510S	UNIT	
Max. instantaneous forward voltage drop per diode	1.5 A	V <sub>F</sub>	1.1								V
Maximum DC reverse current at rated DC blocking voltage per diode	T <sub>A</sub> = 25 °C	I <sub>R</sub>	5.0								μA
	T <sub>A</sub> = 125 °C		500								
Typical junction capacitance per diode		C <sub>J</sub> <sup>(1)</sup>	16								pF

**Note**

<sup>(1)</sup> Measured at 1.0 MHz and applied reverse voltage of 4.0 V

THERMAL CHARACTERISTICS (T <sub>A</sub> = 25 °C unless otherwise noted)										
PARAMETER	SYMBOL	DFL 15005S	DFL 1501S	DFL 1502S	DFL 1504S	DFL 1506S	DFL 1508S	DFL 1510S	UNIT	
Typical thermal resistance	R <sub>θJA</sub> <sup>(1)</sup>					40			°C/W	
	R <sub>θJL</sub> <sup>(1)</sup>					15				

**Note**

<sup>(1)</sup> Units mounted on P.C.B. with 0.51" x 0.51" (13 mm x 13 mm) copper pads

ORDERING INFORMATION (Example)				
PREFERRED P/N	UNIT WEIGHT (g)	PREFERRED PACKAGE CODE	BASE QUANTITY	DELIVERY MODE
DFL1506S-E3/45	0.341	45	50	Tube
DFL1506S-E3/77	0.341	77	1500	13" diameter paper tape and reel

## RATINGS AND CHARACTERISTICS CURVES

(T<sub>A</sub> = 25 °C unless otherwise noted)

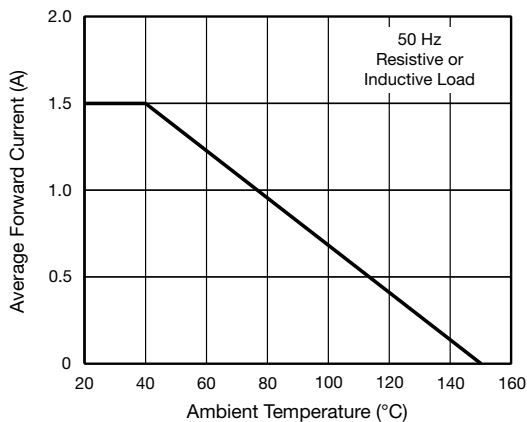

Fig. 1 - Forward Current Derating Curve Per Diode

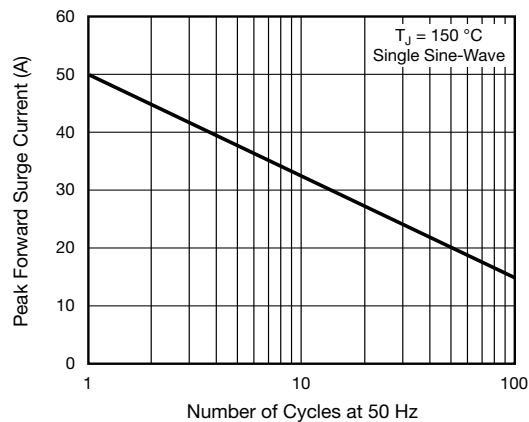

Fig. 2 - Maximum Non-Repetitive Peak Forward Surge Current Per Diode



# DFL15005S thru DFL1510S

Vishay General Semiconductor

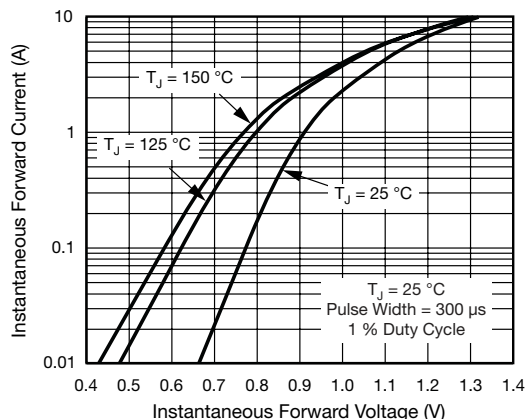

Fig. 3 - Typical Forward Voltage Characteristics Per Diode

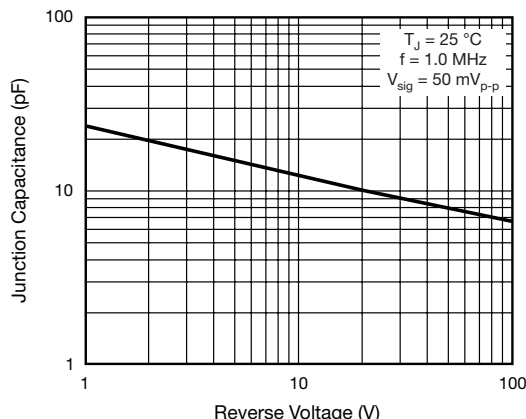

Fig. 5 - Typical Junction Capacitance Per Diode

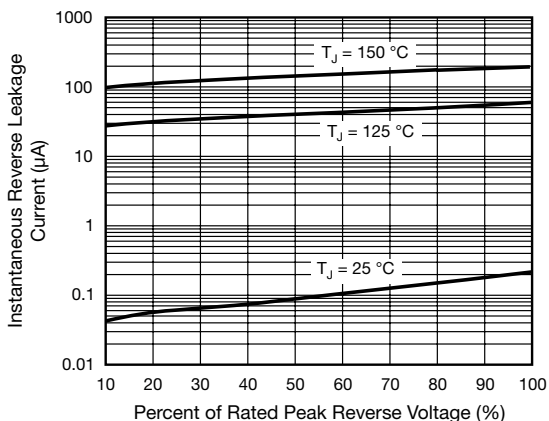
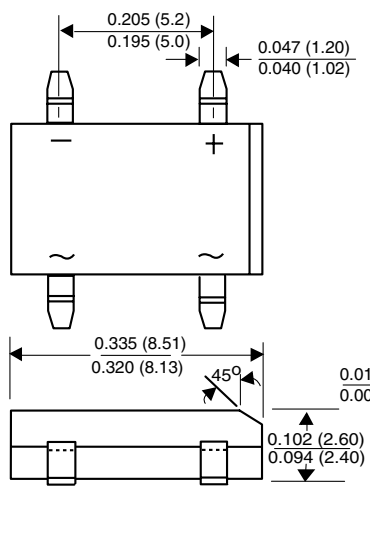

Fig. 4 - Typical Reverse Characteristics Per Diode

## PACKAGE OUTLINE DIMENSIONS in inches (millimeters)

### Case Style Low Profile DFS



### Mounting Pad Layout

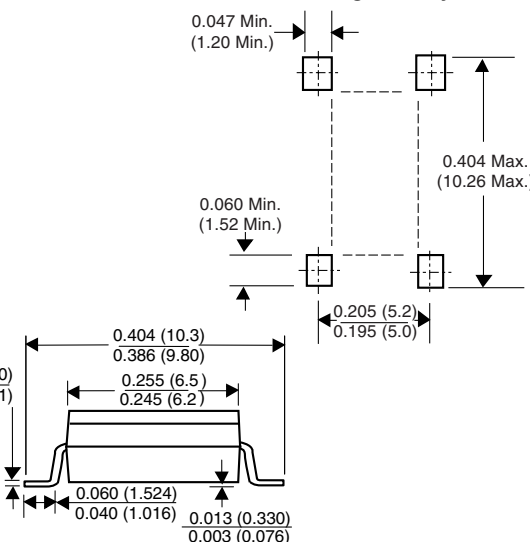



## Disclaimer

ALL PRODUCT, PRODUCT SPECIFICATIONS AND DATA ARE SUBJECT TO CHANGE WITHOUT NOTICE TO IMPROVE RELIABILITY, FUNCTION OR DESIGN OR OTHERWISE.

Vishay Intertechnology, Inc., its affiliates, agents, and employees, and all persons acting on its or their behalf (collectively, "Vishay"), disclaim any and all liability for any errors, inaccuracies or incompleteness contained in any datasheet or in any other disclosure relating to any product.

Vishay makes no warranty, representation or guarantee regarding the suitability of the products for any particular purpose or the continuing production of any product. To the maximum extent permitted by applicable law, Vishay disclaims (i) any and all liability arising out of the application or use of any product, (ii) any and all liability, including without limitation special, consequential or incidental damages, and (iii) any and all implied warranties, including warranties of fitness for particular purpose, non-infringement and merchantability.

Statements regarding the suitability of products for certain types of applications are based on Vishay's knowledge of typical requirements that are often placed on Vishay products in generic applications. Such statements are not binding statements about the suitability of products for a particular application. It is the customer's responsibility to validate that a particular product with the properties described in the product specification is suitable for use in a particular application. Parameters provided in datasheets and/or specifications may vary in different applications and performance may vary over time. All operating parameters, including typical parameters, must be validated for each customer application by the customer's technical experts. Product specifications do not expand or otherwise modify Vishay's terms and conditions of purchase, including but not limited to the warranty expressed therein.

Except as expressly indicated in writing, Vishay products are not designed for use in medical, life-saving, or life-sustaining applications or for any other application in which the failure of the Vishay product could result in personal injury or death. Customers using or selling Vishay products not expressly indicated for use in such applications do so at their own risk and agree to fully indemnify and hold Vishay and its distributors harmless from and against any and all claims, liabilities, expenses and damages arising or resulting in connection with such use or sale, including attorneys fees, even if such claim alleges that Vishay or its distributor was negligent regarding the design or manufacture of the part. Please contact authorized Vishay personnel to obtain written terms and conditions regarding products designed for such applications.

No license, express or implied, by estoppel or otherwise, to any intellectual property rights is granted by this document or by any conduct of Vishay. Product names and markings noted herein may be trademarks of their respective owners.

## Material Category Policy

**Vishay Intertechnology, Inc. hereby certifies that all its products that are identified as RoHS-Compliant fulfill the definitions and restrictions defined under Directive 2011/65/EU of The European Parliament and of the Council of June 8, 2011 on the restriction of the use of certain hazardous substances in electrical and electronic equipment (EEE) - recast, unless otherwise specified as non-compliant.**

**Please note that some Vishay documentation may still make reference to RoHS Directive 2002/95/EC. We confirm that all the products identified as being compliant to Directive 2002/95/EC conform to Directive 2011/65/EU.**



## Стандарт Электрон Связь

Мы молодая и активно развивающаяся компания в области поставок электронных компонентов. Мы поставляем электронные компоненты отечественного и импортного производства напрямую от производителей и с крупнейших складов мира.

Благодаря сотрудничеству с мировыми поставщиками мы осуществляем комплексные и плановые поставки широчайшего спектра электронных компонентов.

Собственная эффективная логистика и склад в обеспечивает надежную поставку продукции в точно указанные сроки по всей России.

Мы осуществляем техническую поддержку нашим клиентам и предпродажную проверку качества продукции. На все поставляемые продукты мы предоставляем гарантию .

Осуществляем поставки продукции под контролем ВП МО РФ на предприятия военно-промышленного комплекса России , а также работаем в рамках 275 ФЗ с открытием отдельных счетов в уполномоченном банке. Система менеджмента качества компании соответствует требованиям ГОСТ ISO 9001.

Минимальные сроки поставки, гибкие цены, неограниченный ассортимент и индивидуальный подход к клиентам являются основой для выстраивания долгосрочного и эффективного сотрудничества с предприятиями радиоэлектронной промышленности, предприятиями ВПК и научно-исследовательскими институтами России.

С нами вы становитесь еще успешнее!

### Наши контакты:

**Телефон:** +7 812 627 14 35

**Электронная почта:** [sales@st-electron.ru](mailto:sales@st-electron.ru)

**Адрес:** 198099, Санкт-Петербург,  
Промышленная ул, дом № 19, литера Н,  
помещение 100-Н Офис 331