

CGH35240F

240 W, 3100-3500 MHz, 50-ohm Input/Output Matched, GaN HEMT for S-Band Radar Systems

Cree's CGH35240F is a gallium nitride (GaN) high electron mobility transistor (HEMT) designed specifically with high efficiency, high gain and wide bandwidth capabilities, which makes the CGH35240F ideal for 3.1-3.5GHz S-Band radar amplifier applications. The transistor is supplied in a ceramic/metal flange package.



Package Type: 440201
PN: CGH35240F

Typical Performance Over 3.1-3.5GHz ($T_c = 25^\circ\text{C}$) of Demonstration Amplifier

Parameter	3.1 GHz	3.2 GHz	3.3 GHz	3.4 GHz	3.5 GHz	Units
Output Power	250	240	225	225	220	W
Gain	12.1	11.9	11.6	11.5	11.4	dB
Power Added Efficiency	60	59	57	52	48	%

Note:

Measured in the CGH35240F-AMP amplifier circuit, under 300 μs pulse width, 20% duty cycle, $P_{IN} = 42 \text{ dBm}$.

Features

- 3.1 - 3.5 GHz Operation
- 240 W Typical Output Power
- 11.6 dB Power Gain at $P_{IN} = 42.0 \text{ dBm}$
- 57 % Typical Power Added Efficiency
- 50 Ohm Internally Matched
- <0.2 dB Pulsed Amplitude Droop

Large Signal Models Available for ADS and MWO



Absolute Maximum Ratings (not simultaneous) at 25°C Case Temperature

Parameter	Symbol	Rating	Units	Conditions
Pulse Width	PW	1	ms	
Duty Cycle	DC	50	%	
Drain-Source Voltage	V_{DSS}	120	Volts	25°C
Gate-to-Source Voltage	V_{GS}	-10, +2	Volts	25°C
Power Dissipation	P_{DISS}	345	Watts	
Storage Temperature	T_{STG}	-65, +150	°C	
Operating Junction Temperature	T_J	225	°C	
Maximum Forward Gate Current	I_{GMAX}	60	mA	25°C
Maximum Drain Current ¹	I_{DMAX}	24	A	25°C
Soldering Temperature ²	T_S	245	°C	
Screw Torque	τ	40	in-oz	
Pulsed Thermal Resistance, Junction to Case ³	$R_{\theta JC}$	0.5	°C/W	85°C
Case Operating Temperature ³	T_C	-40, +150	°C	

Note:

¹ Current limit for long term, reliable operation

² Refer to the Application Note on soldering at www.cree.com/RF/Document-Library

³ Measured for the CGH35240F at $P_{DISS} = 280$ W. Pulse Width = 300 μ S, Duty Cycle = 20%.

Electrical Characteristics ($T_C = 25^\circ\text{C}$)

Characteristics	Symbol	Min.	Typ.	Max.	Units	Conditions
DC Characteristics¹						
Gate Threshold Voltage	$V_{GS(th)}$	-3.8	-3.0	-2.3	V_{DC}	$V_{DS} = 10$ V, $I_D = 57.6$ mA
Gate Quiescent Voltage	$V_{GS(Q)}$	-	-2.7	-	V_{DC}	$V_{DS} = 28$ V, $I_D = 1.0$ A
Saturated Drain Current ²	I_{DS}	46.4	56.0	-	A	$V_{DS} = 6.0$ V, $V_{GS} = 2.0$ V
Drain-Source Breakdown Voltage	V_{BR}	120	-	-	V_{DC}	$V_{GS} = -8$ V, $I_D = 57.6$ mA
RF Characteristics³ ($T_C = 25^\circ\text{C}$, $F_0 = 3.1\text{-}3.5$ GHz unless otherwise noted)						
Output Power ₁ at 3.1 GHz	P_{OUT}	210	250	-	W	$V_{DD} = 28$ V, $I_{DQ} = 1.0$ A, $P_{IN} = 42$ dBm
Output Power ₂ at 3.3 GHz	P_{OUT}	200	225	-	W	$V_{DD} = 28$ V, $I_{DQ} = 1.0$ A, $P_{IN} = 42$ dBm
Output Power ₃ at 3.5 GHz	P_{OUT}	180	220	-	W	$V_{DD} = 28$ V, $I_{DQ} = 1.0$ A, $P_{IN} = 42$ dBm
Power Added Efficiency ₁ at 3.1 GHz	PAE	48	60	-	%	$V_{DD} = 28$ V, $I_{DQ} = 1.0$ A, $P_{IN} = 42$ dBm
Power Added Efficiency ₂ at 3.3 GHz	PAE	48	57	-	%	$V_{DD} = 28$ V, $I_{DQ} = 1.0$ A, $P_{IN} = 42$ dBm
Power Added Efficiency ₃ at 3.5 GHz	PAE	40	48	-	%	$V_{DD} = 28$ V, $I_{DQ} = 1.0$ A, $P_{IN} = 42$ dBm
Power Gain ₁ at 3.1 GHz	G_P	11.0	12.0	-	dB	$V_{DD} = 28$ V, $I_{DQ} = 1.0$ A, $P_{IN} = 42$ dBm
Power Gain ₂ at 3.3 GHz	G_P	10.8	11.5	-	dB	$V_{DD} = 28$ V, $I_{DQ} = 1.0$ A, $P_{IN} = 42$ dBm
Power Gain ₃ at 3.5 GHz	G_P	10.5	11.5	-	dB	$V_{DD} = 28$ V, $I_{DQ} = 1.0$ A, $P_{IN} = 42$ dBm
Small Signal Gain	S21	11.4	14	-	dB	$V_{DD} = 28$ V, $I_{DQ} = 1.0$ A, $P_{IN} = -10$ dBm
Input Return Loss	S11	-	-9	-4.5	dB	$V_{DD} = 28$ V, $I_{DQ} = 1.0$ A, $P_{IN} = -10$ dBm
Output Return Loss	S22	-	-10	-4.5	dB	$V_{DD} = 28$ V, $I_{DQ} = 1.0$ A, $P_{IN} = -10$ dBm
Pulsed Amplitude Droop	D	-	0.1	-	dB	$V_{DD} = 28$ V, $I_{DQ} = 1.0$ A

Notes:

¹ Measured on wafer prior to packaging.

² Scaled from PCM data.

³ Measured in CGH35240F-AMP. Pulse Width = 300 μ S, Duty Cycle = 20%.

Typical Performance

Gain and Return Losses vs Frequency
Measured in CGH35240-AMP Amplifier Circuit.
 $V_{DS} = 28\text{ V}, I_{DS} = 1\text{ A}$

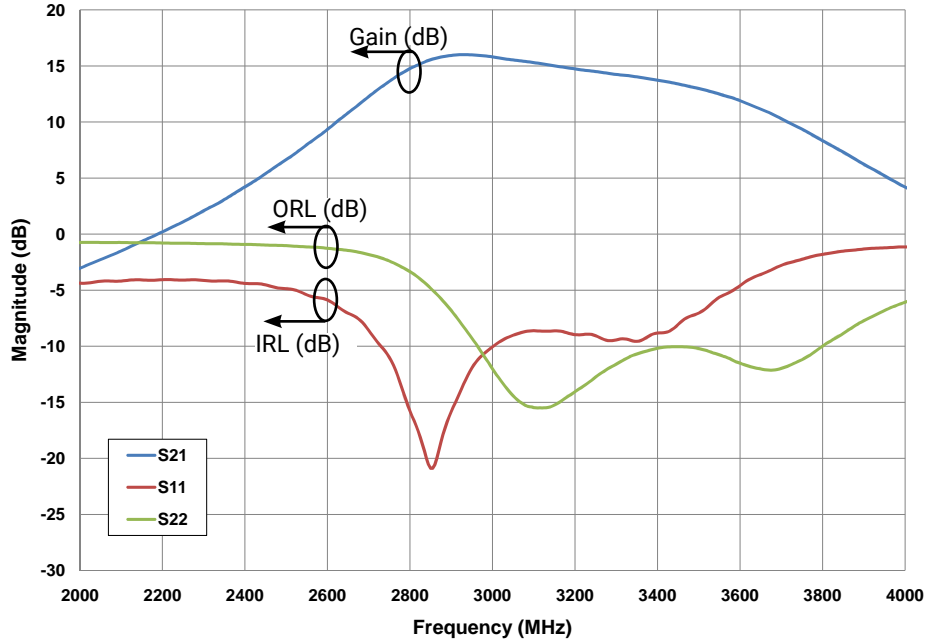

Typical Pulsed Output Power and Power Gain vs Frequency
Measured in CGH35240-AMP Amplifier Circuit.
 $V_{DS} = 28\text{ V}, I_{DS} = 1\text{ A}, P_{IN} = 42\text{ dBm}, \text{Pulse Width} = 300\ \mu\text{s}, \text{Duty Cycle} = 20\%$

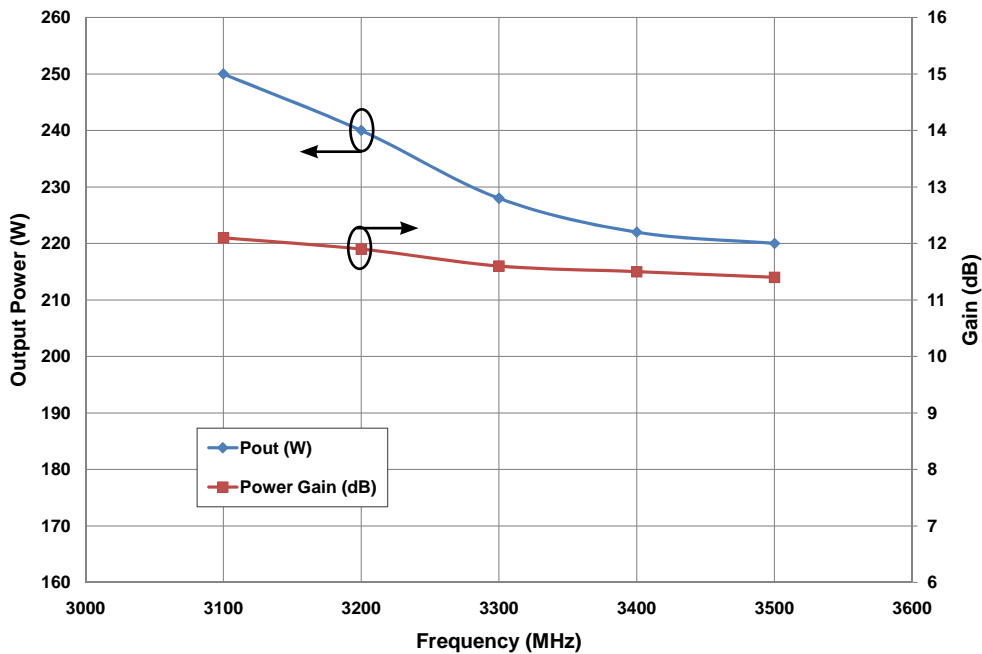

Typical Performance

CGH35240 Output Power vs Input Power
 $V_{DS} = 28\text{ V}$, $I_{DS} = 1\text{ A}$, Pulse Width = $300\ \mu\text{s}$, Duty Cycle = 20 %

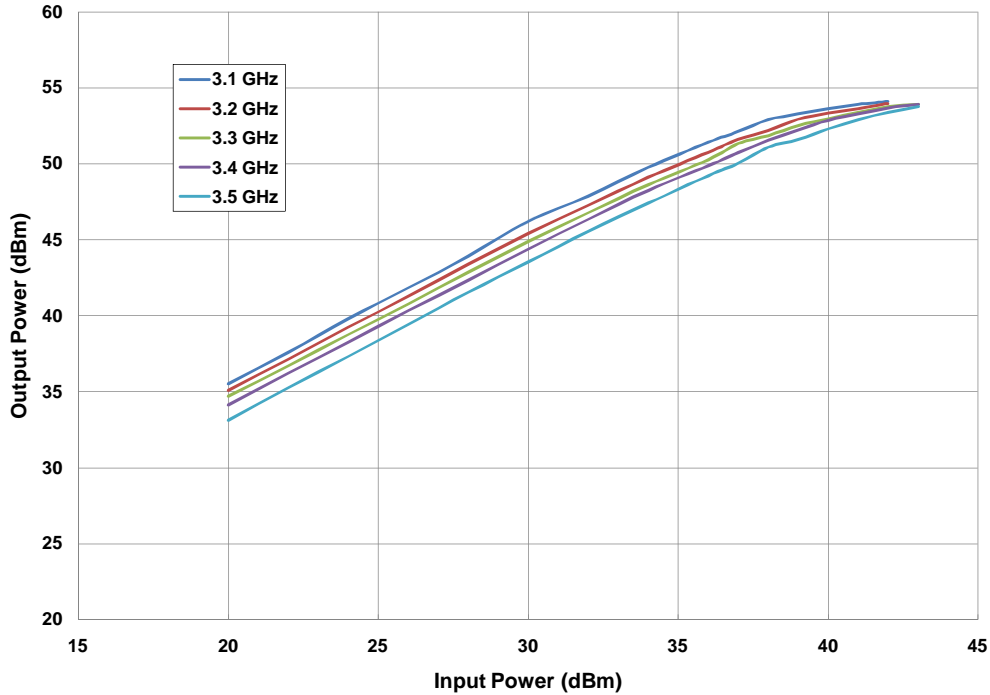

CGH35240 PAE & Gain vs Input Power
 $V_{DS} = 28\text{ V}$, $I_{DS} = 1\text{ A}$, Pulse Width = $300\ \mu\text{s}$, Duty Cycle = 20 %

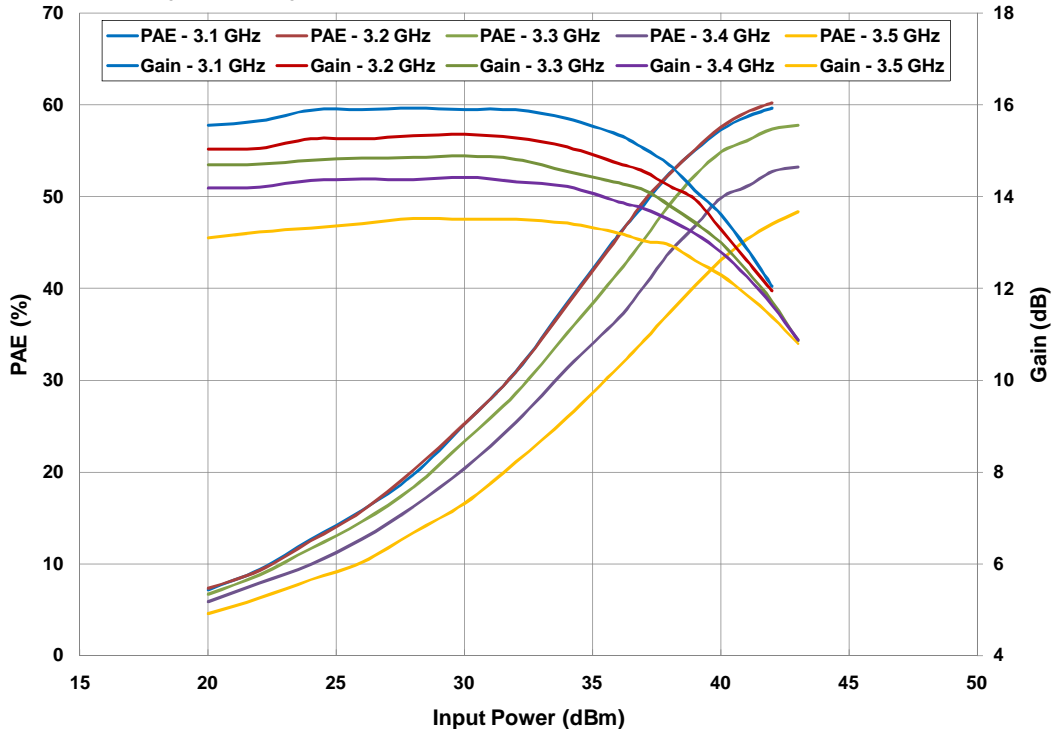

Typical Performance

Typical Pulsed Output Power and Power Added Efficiency vs Frequency Measured in CGH35240-AMP Amplifier Circuit.

$V_{DS} = 28\text{ V}$, $I_{DS} = 1\text{ A}$, $P_{IN} = 42\text{ dBm}$, Pulse Width = $300\text{ }\mu\text{s}$, Duty Cycle = 20%

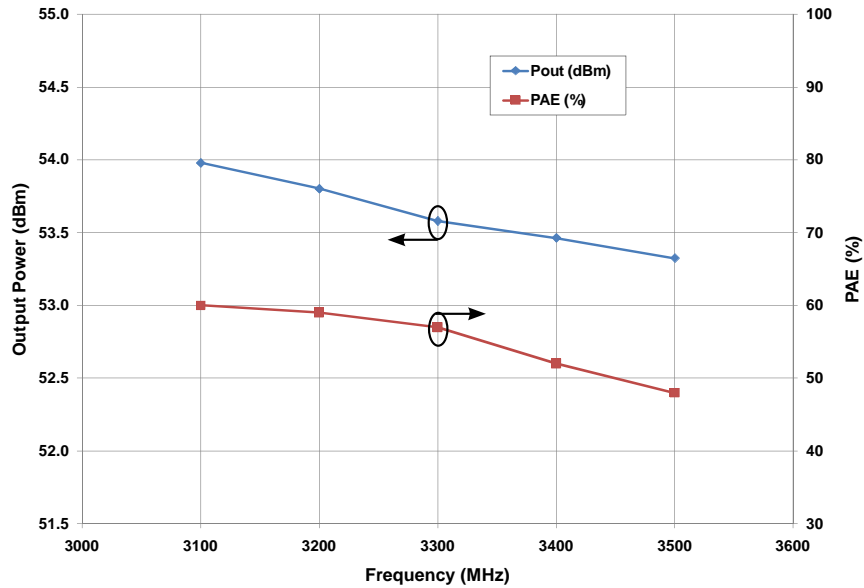

Typical Pulse Droop Performance

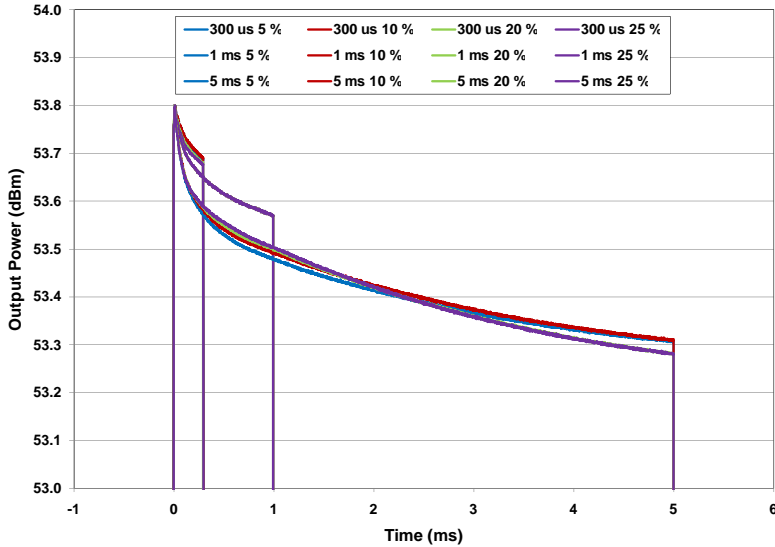

Pulse Width	Duty Cycle (%)	Droop (dB)
10 us	5-25	0.05
50 us	5-25	0.05
100 us	5-25	0.10
300 us	5-25	0.15
1 ms	5-25	0.30
5 ms	5-25	0.60

Electrostatic Discharge (ESD) Classifications

Parameter	Symbol	Class	Test Methodology
Human Body Model	HBM	1A (> 250 V)	JEDEC JESD22 A114-D
Charge Device Model	CDM	II (200 < 500 V)	JEDEC JESD22 C101-C

CGH35240F Transient Thermal Curve

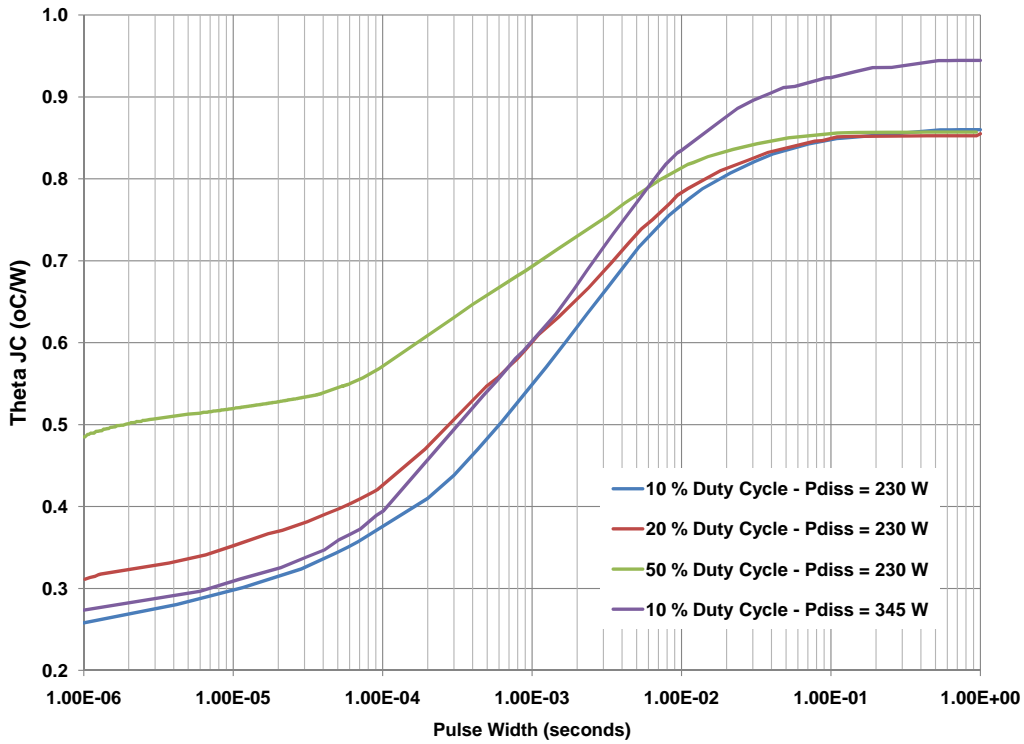

CGH35240F Transient Power Dissipation De-rating Curve

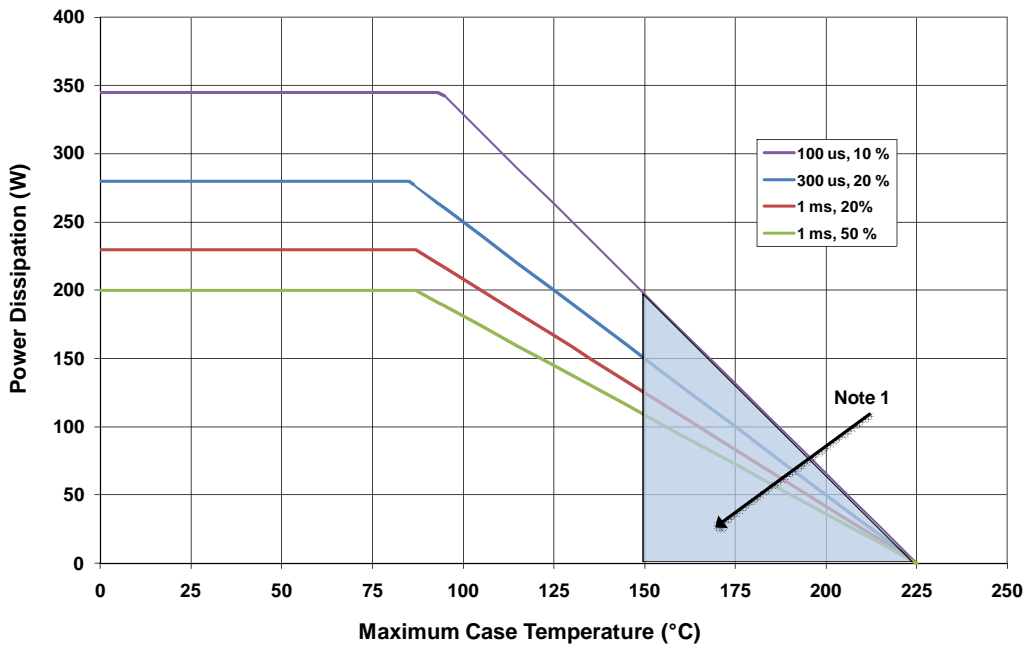

Note 1. Area exceeds Maximum Case Operating Temperature (See Page 2).

CGH35240F-AMP Demonstration Amplifier Circuit Bill of Materials

Designator	Description	Qty
R1	RES, 511 OHM, +/- 1%, 1/16W,0603	1
R2	RES, 5.1,OHM, +/- 1%, 1/16W,0603	1
C1,C3	CAP, 10.0pF, +/-5%,250V, 0603,	2
C2	CAP, 6.8pF, +/- 0.25 pF,250V, 0603	1
C4,C11	CAP, 470PF, +/-5%, 100V, 0603, X	2
C15	CAP, 33 UF, 20%, G CASE	1
C5,C12	CAP,33000PF, 0805,100V, X7R	2
C13	CAP, 1.0UF, 100V, 10%, X7R, 1210	1
C6	CAP 10UF 16V TANTALUM	1
C9,C10	CAP, 10pF, +/- 1%, 250V, 0805	2
C16	CAP, 3300 UF, +/-20%, 100V, ELECTROLYTIC	1
J1,J2	CONN, SMA, PANEL MOUNT JACK, FL	2
J3	HEADER RT>PLZ .1CEN LK 9POS	1
J4	CONNECTOR ; SMB, Straight, JACK,SMD	1
W1	CABLE ,18 AWG, 4.2	1
L1	FERRITE, 22 OHM, 0805, BLM21PG220SN1	1
-	PCB, R04350, 2.5 X 4.0 X 0.030	1
Q1	CGH35240F	1

CGH35240F-AMP Demonstration Amplifier Circuit

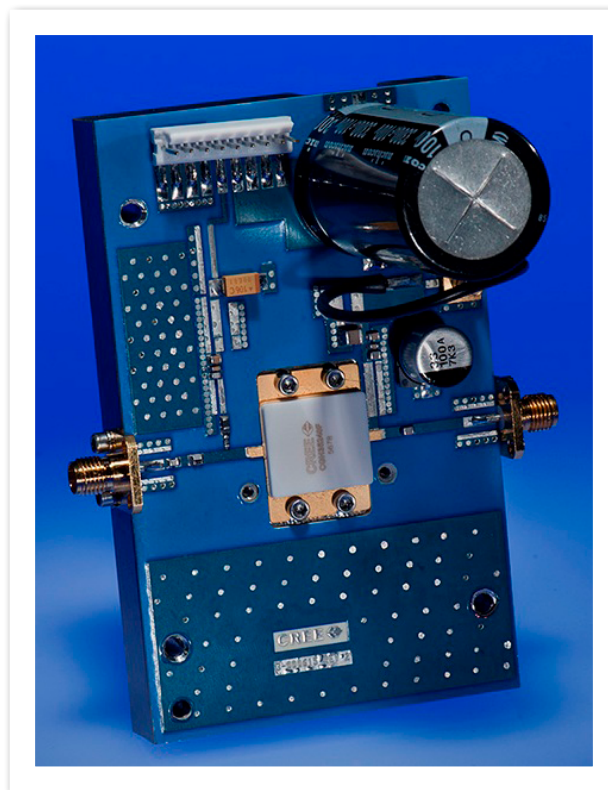

CGH35240F-AMP Demonstration Amplifier Circuit Outline

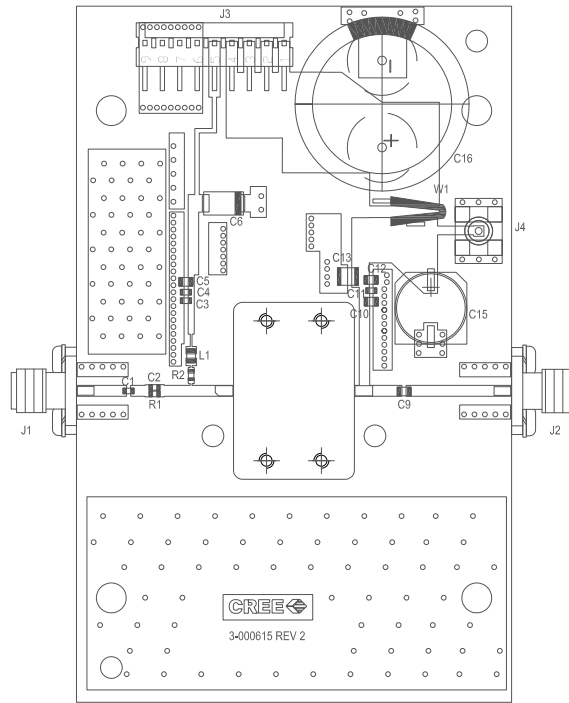

CGH35240F-AMP Demonstration Amplifier Circuit Schematic

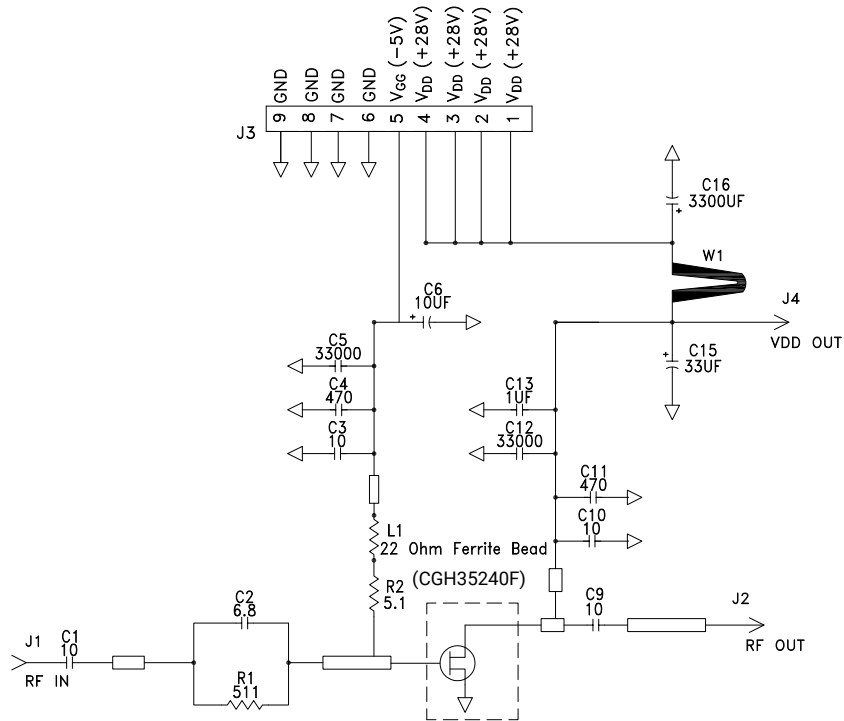



Typical Package S-Parameters for CGH35240F
 (Small Signal, $V_{DS} = 28\text{ V}$, $I_{DQ} = 1000\text{ mA}$, angle in degrees)

Frequency	Mag S11	Ang S11	Mag S21	Ang S21	Mag S12	Ang S12	Mag S22	Ang S22
500 MHz	0.909	-110.39	0.67	85.30	0.001	7.79	0.931	-175.71
600 MHz	0.887	-133.63	0.68	52.25	0.001	-22.14	0.926	161.61
700 MHz	0.861	-157.29	0.67	21.72	0.002	-50.42	0.925	140.70
800 MHz	0.831	178.80	0.65	-6.95	0.002	-74.38	0.924	120.94
900 MHz	0.800	154.60	0.64	-34.16	0.002	-110.45	0.924	101.95
1.0 GHz	0.770	130.18	0.63	-60.27	0.002	-135.64	0.924	83.44
1.2 GHz	0.723	80.74	0.64	-110.13	0.002	166.59	0.919	46.75
1.4 GHz	0.698	29.48	0.69	-160.34	0.002	127.53	0.896	9.09
1.6 GHz	0.618	-28.54	0.76	137.30	0.004	116.81	0.766	-28.92
1.8 GHz	0.443	-48.39	0.45	107.33	0.003	53.00	0.861	-47.01
2.0 GHz	0.569	-89.52	0.69	73.39	0.003	-0.59	0.915	-88.98
2.1 GHz	0.594	-111.61	0.83	51.20	0.004	-23.48	0.913	-108.69
2.2 GHz	0.606	-133.58	1.01	28.33	0.005	-45.69	0.908	-128.26
2.3 GHz	0.607	-155.92	1.25	4.25	0.007	-71.50	0.902	-148.11
2.4 GHz	0.595	-179.54	1.59	-21.28	0.009	-99.04	0.895	-168.80
2.5 GHz	0.561	154.35	2.11	-49.48	0.013	-129.12	0.883	169.09
2.6 GHz	0.499	124.82	2.87	-80.80	0.018	-161.39	0.861	144.62
2.7 GHz	0.376	85.52	4.03	-118.36	0.027	161.11	0.813	115.40
2.8 GHz	0.177	20.59	5.38	-164.13	0.039	115.01	0.690	79.55
2.9 GHz	0.165	-127.79	6.17	144.62	0.049	64.36	0.480	37.79
3.0 GHz	0.309	163.81	6.11	96.28	0.052	15.24	0.288	-7.26
3.1 GHz	0.354	118.49	5.80	52.70	0.052	-28.98	0.208	-64.36
3.2 GHz	0.329	74.79	5.47	11.41	0.052	-70.29	0.236	-120.98
3.3 GHz	0.286	23.15	5.19	-29.09	0.052	-110.99	0.302	-160.98
3.4 GHz	0.300	-38.01	4.94	-70.05	0.052	-151.88	0.354	167.78
3.5 GHz	0.406	-96.34	4.55	-112.29	0.050	165.57	0.350	142.39
3.6 GHz	0.565	-143.08	4.00	-154.80	0.046	122.85	0.300	127.36
3.7 GHz	0.708	177.87	3.32	163.85	0.040	81.34	0.271	127.66
3.8 GHz	0.799	143.73	2.64	125.19	0.033	42.95	0.321	129.68
3.9 GHz	0.847	113.69	2.09	89.39	0.027	7.05	0.410	122.23
4.0 GHz	0.868	85.65	1.65	56.14	0.022	-25.45	0.497	108.92
4.2 GHz	0.853	30.51	1.10	-6.76	0.016	-84.72	0.622	78.62
4.4 GHz	0.803	-32.21	0.75	-69.35	0.012	-148.46	0.700	47.77
4.6 GHz	0.765	-101.68	0.51	-131.73	0.008	147.89	0.743	16.36
4.8 GHz	0.770	-166.93	0.32	167.88	0.005	101.70	0.762	-17.52
5.0 GHz	0.785	141.18	0.20	113.11	0.004	59.25	0.747	-56.70
5.2 GHz	0.786	100.39	0.13	60.03	0.005	5.11	0.676	-106.08
5.4 GHz	0.761	65.91	0.08	-1.66	0.007	-83.46	0.447	-179.99
5.6 GHz	0.691	35.57	0.03	-48.77	0.005	159.03	0.055	2 122.03
5.8 GHz	0.608	11.51	0.02	-59.15	0.004	57.07	0.310	23.86
6.0 GHz	0.604	-18.74	0.01	-102.12	0.003	-9.32	0.594	-75.04

To download the s-parameters in s2p format, go to the [CGH35240F Product Page](#) and click on the documentation tab.

Product Dimensions CGH35240F (Package Type – 440201)

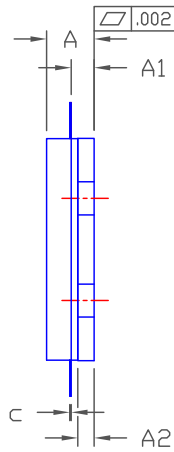
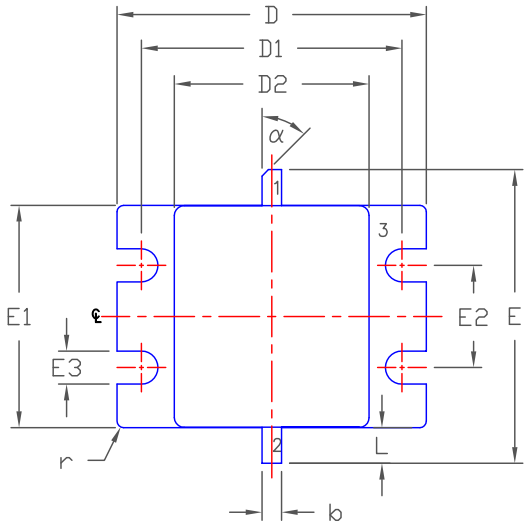



- PIN 1. GATE
 2. DRAIN
 3. SOURCE

NOTES:

1. DIMENSIONING AND TOLERANCING PER ANSI Y14.5M - 1994.
2. CONTROLLING DIMENSION: INCH.
3. ADHESIVE FROM LID MAY EXTEND A MAXIMUM OF 0.020" BEYOND EDGE OF LID.
4. LID MAY BE MISALIGNED TO THE BODY OF PACKAGE BY A MAXIMUM OF 0.008" IN ANY DIRECTION.

DIM	INCHES		MILLIMETERS		NOTES
	MIN	MAX	MIN	MAX	
A	0.128	0.148	3.25	3.76	
A1	0.057	0.067	1.45	1.70	
A2	0.035	0.045	0.89	1.14	
b	0.055	0.065	1.40	1.65	2x
c	0.004	0.007	0.08	0.15	
D	0.948	0.958	24.08	24.33	
D1	0.798	0.808	20.27	20.52	
D2	0.595	0.605	15.11	15.37	
E	0.880	0.930	22.35	23.62	
E1	0.680	0.694	17.27	17.63	
E2	0.310	0.320	7.87	8.13	
E3	0.097	0.107	2.46	2.72	4x
L	0.095	0.125	2.41	3.18	2x
r	0.02 TYP		0.51 TYP		4x
α	45° REF		45° REF		

Product Ordering Information

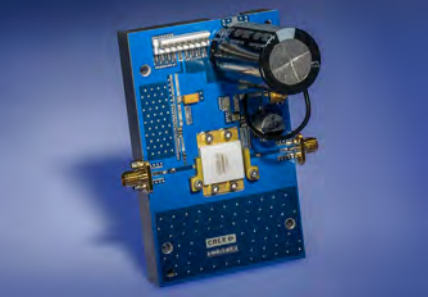
Order Number	Description	Unit of Measure	Image
CGH35240F	GaN HEMT	Each	
CGH35240F-TB	Test board without GaN HEMT	Each	
CGH35240F-AMP	Test board with GaN HEMT installed	Each	



Disclaimer

Specifications are subject to change without notice. Cree, Inc. believes the information contained within this data sheet to be accurate and reliable. However, no responsibility is assumed by Cree for any infringement of patents or other rights of third parties which may result from its use. No license is granted by implication or otherwise under any patent or patent rights of Cree. Cree makes no warranty, representation or guarantee regarding the suitability of its products for any particular purpose. "Typical" parameters are the average values expected by Cree in large quantities and are provided for information purposes only. These values can and do vary in different applications and actual performance can vary over time. All operating parameters should be validated by customer's technical experts for each application. Cree products are not designed, intended or authorized for use as components in applications intended for surgical implant into the body or to support or sustain life, in applications in which the failure of the Cree product could result in personal injury or death or in applications for planning, construction, maintenance or direct operation of a nuclear facility.

For more information, please contact:

Cree, Inc.
4600 Silicon Drive
Durham, North Carolina, USA 27703
www.cree.com/RF

Sarah Miller
Marketing & Export
Cree, RF Components
1.919.407.5302

Ryan Baker
Marketing
Cree, RF Components
1.919.407.7816

Tom Dekker
Sales Director
Cree, RF Components
1.919.407.5639



Стандарт Электрон Связь

Мы молодая и активно развивающаяся компания в области поставок электронных компонентов. Мы поставляем электронные компоненты отечественного и импортного производства напрямую от производителей и с крупнейших складов мира.

Благодаря сотрудничеству с мировыми поставщиками мы осуществляем комплексные и плановые поставки широчайшего спектра электронных компонентов.

Собственная эффективная логистика и склад в обеспечивает надежную поставку продукции в точно указанные сроки по всей России.

Мы осуществляем техническую поддержку нашим клиентам и предпродажную проверку качества продукции. На все поставляемые продукты мы предоставляем гарантию .

Осуществляем поставки продукции под контролем ВП МО РФ на предприятия военно-промышленного комплекса России , а также работаем в рамках 275 ФЗ с открытием отдельных счетов в уполномоченном банке. Система менеджмента качества компании соответствует требованиям ГОСТ ISO 9001.

Минимальные сроки поставки, гибкие цены, неограниченный ассортимент и индивидуальный подход к клиентам являются основой для выстраивания долгосрочного и эффективного сотрудничества с предприятиями радиоэлектронной промышленности, предприятиями ВПК и научно-исследовательскими институтами России.

С нами вы становитесь еще успешнее!

Наши контакты:

Телефон: +7 812 627 14 35

Электронная почта: sales@st-electron.ru

Адрес: 198099, Санкт-Петербург,
Промышленная ул, дом № 19, литера Н,
помещение 100-Н Офис 331