

TABLE OF CONTENTS

Features	1
General Description	1
Functional Block Diagram	1
Revision History	2
Specifications.....	3
Absolute Maximum Ratings.....	5
ESD Caution.....	5
Pin Configurations and Function Descriptions	6
Theory of Operation	8
Connections for dB Operation	8

REVISION HISTORY

3/2019—Rev. F to Rev. G

Changes to Figure 5 and Table 5.....	7
Change to Figure 16	12
Changes to Ordering Guide	15

11/2014—Rev. E to Rev. F

Change to Figure 1	1
Changes to Table 1.....	3
Change to Figure 16	12
Changes to Ordering Guide	15

7/2012—Rev. D to Rev. E

Reorganized Layout.....	Universal
Changes to Figure 1	1
Changes to Figure 6.....	8
Changes to Figure 7.....	9
Changes to Figure 13, Figure 14, and Figure 15	11
Changes to Figure 16, Figure 17, and Single-Supply Operation Section.....	12
Changes to Figure 21	13
Updated Outline Dimensions	14

8/2008—Rev. C to Rev. D

Changes to Features Section.....	1
Changes to General Description Section	1
Changes to Figure 1.....	1
Changes to Table 2.....	5

Frequency Response	9
AC Measurement Accuracy and Crest Factor	9
Applications Information	11
Typical Connections	11
Optional External Trims For High Accuracy	11
Single-Supply Operation	12
Choosing the Averaging Time Constant.....	12
Outline Dimensions	14
Ordering Guide	15

Change to Figure 2	5
Changes to Figure 15.....	10
Changes to Connections for dB Operation Section	11
Changes to Figure 17.....	12
Changes to Frequency Response Section	12
Updated Outline Dimensions.....	14
Changes to Ordering Guide	15

3/2006—Rev. B to Rev. C

Updated Format.....	Universal
Changed Product Description to General Description.....	1
Changes to General Description	1
Changes to Table 1.....	3
Changes to Table 2.....	5
Added Pin Configurations and Function Descriptions	6
Changed Standard Connection to Typical Connections	8
Changed Single Supply Connection to Single Supply Operation.....	9
Changes to Connections for dB Operation.....	11
Changes to Figure 17.....	12
Updated Outline Dimensions.....	14
Changes to Ordering Guide	15

6/1999—Rev. A to Rev. B

1/1976—Revision 0: Initial Version

SPECIFICATIONS

T_A = +25°C and ±15 V dc, unless otherwise noted.

Table 1.

Parameter	AD536AJ			AD536AK			AD536AS			Unit
	Min	Typ	Max	Min	Typ	Max	Min	Typ	Max	
TRANSFER FUNCTION	$V_{OUT} = \sqrt{\text{Avg}(V_{IN})^2}$			$V_{OUT} = \sqrt{\text{Avg}(V_{IN})^2}$			$V_{OUT} = \sqrt{\text{Avg}(V_{IN})^2}$			
CONVERSION ACCURACY										
Total Error, Internal Trim ¹ (See Figure 13)	±5 ± 0.5			±2 ± 0.2			±5 ± 0.5			mV ± % of rdg
vs. Temperature										
T _{MIN} to +70°C	±0.1 ± 0.01			±0.05 ± 0.005			±0.1 ± 0.005			mV ± % of rdg/°C
+70°C to +125°C							±0.3 ± 0.005			mV ± % of rdg/°C
vs. Supply Voltage	±0.1 ± 0.01			±0.1 ± 0.01			±0.1 ± 0.01			mV ± % of rdg/V
DC Reversal Error	±0.2			±0.1			±0.2			mV ± % of rdg
Total Error, External Trim ¹ (See Figure 16)	±3 ± 0.3			±2 ± 0.1			±3 ± 0.3			mV ± % of rdg
ERROR VS. CREST FACTOR ²										
Crest Factor 1 to Crest Factor 2	Specified accuracy			Specified accuracy			Specified accuracy			
Crest Factor = 3	-0.1			-0.1			-0.1			% of rdg
Crest Factor = 7	-1.0			-1.0			-1.0			% of rdg
FREQUENCY RESPONSE ³										
Bandwidth for 1% Additional Error (0.09 dB)										
V _{IN} = 10 mV	5			5			5			kHz
V _{IN} = 100 mV	45			45			45			kHz
V _{IN} = 1 V	120			120			120			kHz
±3 dB Bandwidth										
V _{IN} = 10 mV	90			90			90			kHz
V _{IN} = 100 mV	450			450			450			kHz
V _{IN} = 1 V	2.3			2.3			2.3			MHz
AVERAGING TIME CONSTANT (See Figure 19)	25			25			25			ms/μF
INPUT CHARACTERISTICS										
Signal Range, ±15 V Supplies										
Continuous RMS Level	0 to 7			0 to 7			0 to 7			V rms
Peak Transient Input	±20			±20			±20			V peak
Continuous RMS Level, V _S = ±5 V	0 to 2			0 to 2			0 to 2			V rms
Peak Transient Input, V _S = ±5 V	±7			±7			±7			V peak
Maximum Continuous Nondestructive Input Level (All Supply Voltages)	±25			±25			±25			V peak
Input Resistance	13.33	16.67	20	13.33	16.67	20	13.33	16.67	20	kΩ
Input Offset Voltage	0.8 ± 2			0.5 ± 1			0.8 ± 2			mV
OUTPUT CHARACTERISTICS										
Offset Voltage, V _{IN} = COM (See Figure 13)	±1 ± 2			±0.5 ± 1			±2			mV
vs. Temperature	±0.1			±0.1			±0.2			mV/°C
vs. Supply Voltage	±0.1			±0.1			±0.2			mV/V
Voltage Swing, ±15 V Supplies	0 to +11			0 to +11			0 to +11			V
± 5 V Supply	0 to +2			0 to +2			0 to +2			V
dB OUTPUT, 0 dB = 1 V rms (See Figure 7)										
Error, 7 mV < V _{IN} < 7 V rms	±0.4 ± 0.6			±0.2 ± 0.3			±0.5 ± 0.6			dB
Scale Factor	-3			-3			-3			mV/dB
Scale Factor Temperature Coefficient	-0.033			-0.033			-0.033			dB/°C
Uncompensated	+0.33			+0.33			+0.33			% of rdg/°C
I _{REF} for 0 dB = 1 V rms	5	20	80	5	20	80	5	20	80	μA
I _{REF} Range	1 100			1 100			1 100			μA

Parameter	AD536AJ			AD536AK			AD536AS			Unit
	Min	Typ	Max	Min	Typ	Max	Min	Typ	Max	
I_{OUT} TERMINAL										
I _{OUT} Scale Factor		40			40			40		μA/V rms
I _{OUT} Scale Factor Tolerance		±10	±20		±10	±20		±10	±20	%
Output Resistance	20	25	30	20	25	30	20	25	30	kΩ
Voltage Compliance		-V _S to (+V _S - 2.5 V)			-V _S to (+V _S - 2.5 V)			-V _S to (+V _S - 2.5 V)		V
BUFFER AMPLIFIER										
Input and Output Voltage Range	-V _S to (+V _S - 2.5V)			-V _S to (+V _S - 2.5V)			-V _S to (+V _S - 2.5V)			V
Input Offset Voltage, R _S = 25 kΩ		±0.5	±4		±0.5	±4		±0.5	±4	mV
Input Bias Current		20	60		20	60		20	60	nA
Input Resistance		10 ⁸			10 ⁸			10 ⁸		Ω
Output Current	(+5 mA, -130 μA)			(+5 mA, -130 μA)			(+5 mA, -130 μA)			
Short-Circuit Current		20			20			20		mA
Output Resistance			0.5			0.5			0.5	Ω
Small-Signal Bandwidth		1			1			1		MHz
Slew Rate ⁴		5			5			5		V/μs
POWER SUPPLY										
Voltage Rated Performance		±15			±15			±15		V
Dual Supply	±3.0		±18	±3.0		±18	±3.0		±18	V
Single Supply	+5		+36	+5		+36	+5		+36	V
Quiescent Current										
Total V _S , 5 V to 36 V, T _{MIN} to T _{MAX}		1.2	2		1.2	2		1.2	2	mA
TEMPERATURE RANGE										
Rated Performance	0		+70	0		+70	-55		+125	°C
Storage	-55		+150	-55		+150	-55		+150	°C
NUMBER OF TRANSISTORS										
		65			65			65		

¹ Accuracy is specified for 0 V to 7 V rms, dc or 1 kHz sine wave input with the AD536A connected as in the figure referenced.

² Error vs. crest factor is specified as an additional error for 1 V rms rectangular pulse input, pulse width = 200 μs.

³ Input voltages are expressed in volts rms, and error is expressed as a percentage of the reading.

⁴ With 2 kΩ external pull-down resistor.

ABSOLUTE MAXIMUM RATINGS

Table 2.

Parameter	Rating
Supply Voltage	
Dual Supply	±18 V
Single Supply	+36 V
Internal Power Dissipation	500 mW
Maximum Input Voltage	±25 V peak
Buffer Maximum Input Voltage	±V _S
Maximum Input Voltage	±25 V peak
Storage Temperature Range	−55°C to +150°C
Operating Temperature Range	
AD536AJ/AD536AK	0°C to +70°C
AD536AS	−55°C to +125°C
Lead Temperature (Soldering, 60 sec)	300°C
ESD Rating	1000 V
Thermal Resistance θ_{JA} ¹	
10-Pin Header (H-10 Package)	150°C/W
20-Terminal LCC (E-20 Package)	95°C/W
14-Lead SBDIP (D-14 Package)	95°C/W
14-Lead CERDIP (Q-14 Package)	95°C/W

¹ θ_{JA} is specified for the worst-case conditions, that is, a device soldered in a circuit board for surface-mount packages.

Stresses at or above those listed under Absolute Maximum Ratings may cause permanent damage to the product. This is a stress rating only; functional operation of the product at these or any other conditions above those indicated in the operational section of this specification is not implied. Operation beyond the maximum operating conditions for extended periods may affect product reliability.

ESD CAUTION



ESD (electrostatic discharge) sensitive device. Charged devices and circuit boards can discharge without detection. Although this product features patented or proprietary protection circuitry, damage may occur on devices subjected to high energy ESD. Therefore, proper ESD precautions should be taken to avoid performance degradation or loss of functionality.



PAD NUMBERS CORRESPOND TO PIN NUMBERS FOR THE TO-100 14-LEAD CERAMIC DIP PACKAGE.

¹BOTH PADS SHOWN MUST BE CONNECTED TO V_{IN}. THE AD536A IS AVAILABLE IN LASER-TRIMMED CHIP FORM. SUBSTRATE CONNECTED TO −V_S.

00504-002

Figure 2. Die Dimensions and Pad Layout
Dimensions shown in inches and (millimeters)

PIN CONFIGURATIONS AND FUNCTION DESCRIPTIONS



Figure 3. D-14 and Q-14 Packages Pin Configuration

Table 3. D-14 and Q-14 Packages Pin Function Descriptions

Pin No.	Mnemonic	Description
1	V_{IN}	Input Voltage
2	NC	No Connection
3	$-V_S$	Negative Supply Voltage
4	C_{AV}	Averaging Capacitor
5	dB	Log (dB) Value of the RMS Output Voltage
6	BUF OUT	Buffer Output
7	BUF IN	Buffer Input
8	I_{OUT}	RMS Output Current
9	R_L	Load Resistor
10	COM	Common
11	NC	No Connection
12	NC	No Connection
13	NC	No Connection
14	$+V_S$	Positive Supply Voltage

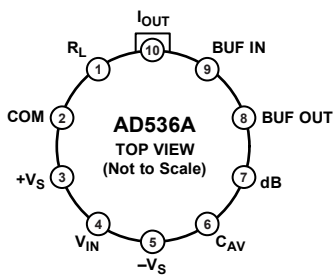

Figure 4. H-10 Package Pin Configuration

Table 4. H-10 Package Pin Function Descriptions

Pin No.	Mnemonic	Description
1	R_L	Load Resistor
2	COM	Common
3	$+V_S$	Positive Supply Voltage
4	V_{IN}	Input Voltage
5	$-V_S$	Negative Supply Voltage
6	C_{AV}	Averaging Capacitor
7	dB	Log (dB) Value of the RMS Output Voltage
8	BUF OUT	Buffer Output
9	BUF IN	Buffer Input
10	I_{OUT}	RMS Output Current



Figure 5. E-20-1 Package Pin Configuration

Table 5. E-20-1 Package Pin Function Descriptions

Pin No.	Mnemonic	Description
1	NC	No Connection
2	V _{IN}	Input Voltage
3	NC	No Connection
4	-V _S	Negative Supply Voltage
5	NC	No Connection
6	C _{AV}	Averaging Capacitor
7	NC	No Connection
8	dB	Log (dB) Value of the RMS Output Voltage
9	BUF OUT	Buffer Output
10	BUF IN	Buffer Input
11	NC	No Connection
12	I _{OUT}	RMS Output Current
13	R _L	Load Resistor
14	COM	Common
15	NC	No Connection
16	NC	No Connection
17	NC	No Connection
18	NC	No Connection
19	NC	No Connection
20	+V _S	Positive Supply Voltage

THEORY OF OPERATION

The AD536A embodies an implicit solution of the rms equation that overcomes the dynamic range as well as other limitations inherent in a straightforward computation of rms. The actual computation performed by the AD536A follows the equation

$$V_{rms} = \text{Avg} \left[\frac{V_{IN}^2}{V_{rms}} \right]$$

Figure 6 is a simplified schematic of the AD536A. Note that it is subdivided into four major sections: absolute value circuit (active rectifier), squarer/divider, current mirror, and buffer amplifier. The input voltage (V_{IN}), which can be ac or dc, is converted to a unipolar current (I_1) by the active rectifiers (A_1, A_2). I_1 drives one input of the squarer/divider, which has the transfer function

$$I_4 = I_1^2 / I_3$$

The output current, I_4 , of the squarer/divider drives the current mirror through a low-pass filter formed by R_1 and the externally connected capacitor, C_{AV} . If the $R_1 C_{AV}$ time constant is much greater than the longest period of the input signal, then I_4 is effectively averaged. The current mirror returns a current I_3 , which equals $\text{Avg}[I_4]$, back to the squarer/divider to complete the implicit rms computation. Thus,

$$I_4 = \text{Avg}[I_1^2 / I_4] = I_1 \text{ rms}$$

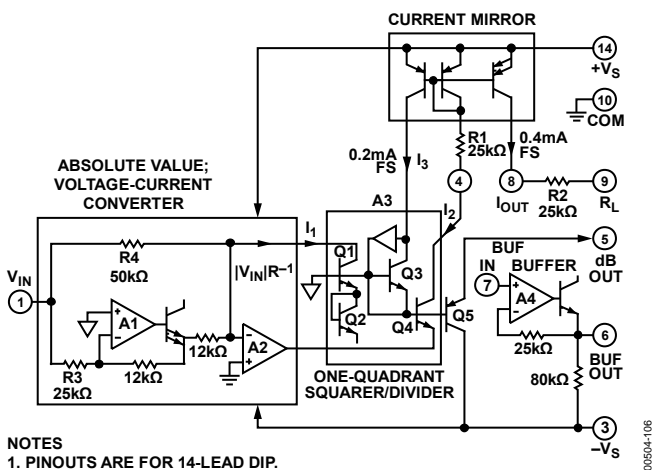

Figure 6. Simplified Schematic

The current mirror also produces the output current, I_{OUT} , which equals $2I_4$. I_{OUT} can be used directly or can be converted to a voltage with R_2 and buffered by A_4 to provide a low impedance voltage output. The transfer function of the AD536A results in the following:

$$V_{OUT} = 2R_2 \times I_{rms} = V_{IN} \text{ rms}$$

The dB output is derived from the emitter of Q_3 because the voltage at this point is proportional to $-\log V_{IN}$. The emitter follower, Q_5 , buffers and level shifts this voltage so that the dB output voltage is zero when the externally supplied emitter current (I_{REF}) to Q_5 approximates I_3 .

CONNECTIONS FOR dB OPERATION

The logarithmic (or decibel) output of the AD536A is one of its most powerful features. The internal circuit computing dB works accurately over a 60 dB range. The connections for dB measurements are shown in Figure 7.

Select the 0 dB level by adjusting R_1 for the proper 0 dB reference current (which is set to cancel the log output current from the squarer/divider at the desired 0 dB point). The external op amp provides a more convenient scale and allows compensation of the $+0.33\%/^{\circ}\text{C}$ scale factor drift of the dB output pin.

The temperature-compensating resistor, R_2 , is available online in several styles from Precision Resistor Company, Inc., (Part Number AT35 and Part Number ST35). The average temperature coefficients of R_2 and R_3 result in the $+3300$ ppm required to compensate for the dB output. The linear rms output is available at Pin 8 on the DIP or Pin 10 on the header device with an output impedance of $25\text{ k}\Omega$. Some applications require an additional buffer amplifier if this output is desired.

For dB calibration,

1. Set $V_{IN} = 1.00\text{ V dc}$ or 1.00 V rms .
2. Adjust R_1 for dB output = 0.00 V .
3. Set $V_{IN} = +0.1\text{ V dc}$ or 0.10 V rms .
4. Adjust R_5 for dB output = -2.00 V .

Any other desired 0 dB reference level can be used by setting V_{IN} and adjusting R_1 accordingly. Note that adjusting R_5 for the proper gain automatically provides the correct temperature compensation.



¹SPECIAL TC COMPENSATION RESISTOR, +3300ppm/°C, PRECISION RESISTOR COMPANY PART NUMBER AT 35 OR PART NUMBER ST35.

Figure 7. dB Connection

00504-107

FREQUENCY RESPONSE

The AD536A utilizes a logarithmic circuit in performing the implicit rms computation. As with any log circuit, bandwidth is proportional to signal level. The solid lines in the graph of Figure 8 represent the frequency response of the AD536A at input levels from 10 mV rms to 7 V rms. The dashed lines indicate the upper frequency limits for 1%, 10%, and ±3 dB of reading additional error. For example, note that a 1 V rms signal produces less than 1% of reading additional error up to 120 kHz. A 10 mV signal can be measured with 1% of reading additional error (100 μV) up to only 5 kHz.



Figure 8. High Frequency Response

00504-016

Figure 9 illustrates a curve of reading error for the AD536A for a 1 V rms input signal with crest factors from 1 to 11. A rectangular pulse train (pulse width = 100 μs) was used for this test because it is the worst-case waveform for rms measurement (all of the energy is contained in the peaks). The duty cycle and peak amplitude were varied to produce crest factors from 1 to 11 while maintaining a constant 1 V rms input amplitude.



Figure 9. Error vs. Crest Factor

00504-017

AC MEASUREMENT ACCURACY AND CREST FACTOR

Crest factor is often overlooked when determining the accuracy of an ac measurement. The definition of crest factor is the ratio of the peak signal amplitude to the rms value of the signal ($CF = V_p/V_{rms}$). Most common waveforms, such as sine and triangle waves, have relatively low crest factors (<2). Waveforms that resemble low duty cycle pulse trains, such as those occurring in switching power supplies and SCR circuits, have high crest factors. For example, a rectangular pulse train with a 1% duty cycle has a crest factor of 10 ($CF = 1/\sqrt{\eta}$).



Figure 10. Error vs. Pulse Width Rectangular Pulse

00504-018

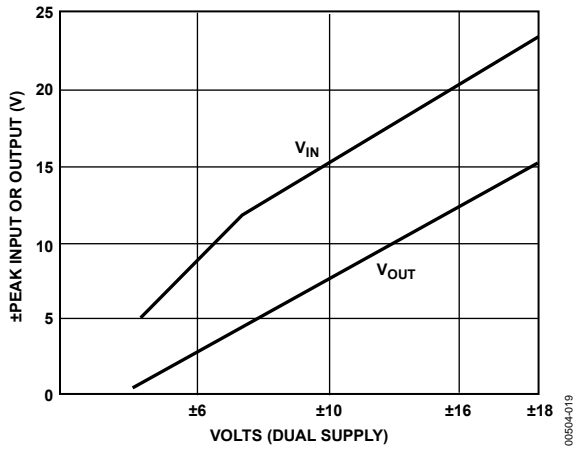

Figure 11. Input and Output Voltage Ranges vs. Dual Supply

00564-019

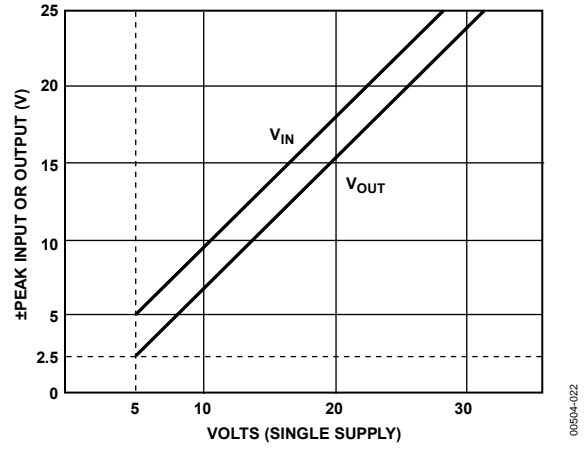

Figure 12. Input and Output Voltage Ranges vs. Single Supply

00564-022



Figure 16. Optional External Gain and Output Offset Trims

SINGLE-SUPPLY OPERATION

Refer to Figure 17 for single supply-rail configurations between 5 V and 36 V. When powered from a single supply, the input stage (VIN pin) is internally biased at a voltage between ground and the supply, and the input signal ac coupled. Biasing the device between the supply and ground is simply a matter of connecting the COM pin to an external resistor divider and bypassing to ground. The resistor values are large, minimizing power consumption, as the COM pin current is only 5 μA.

Note that the 10 kΩ and 20 kΩ resistors connected to the COM pin (Figure 17) are asymmetrical, that is, the voltage at the COM pin is 1/3 of the supply. This ratio of input bias to supply is optimum for the precision rectifier (aka absolute value circuit) input circuit employed for rectifying ac input waveforms and ensures full input symmetry for low signal voltages.

Capacitor C2 is required for AC input coupling, however an external dc return is unnecessary because biasing occurs internally. Select C2 for the desired low frequency breakpoint using an input resistance of 16.7 kΩ for the 1/ωRC calculation; C2 = 1 μF for a cutoff at 10 Hz. Figure 11 and Figure 12 show the input and output signal ranges for dual and single supply configurations, respectively. The load resistor, RL, provides a path to sink output sink current when an input signal is disconnected.



Figure 17. Single-Supply Connection

CHOOSING THE AVERAGING TIME CONSTANT

The AD536A computes the rms of both ac and dc signals. If the input is a slowly varying dc signal, the output of the AD536A tracks the input exactly.

At higher frequencies, the average output of the AD536A approaches the rms value of the input signal. The actual output of the AD536A differs from the ideal output by a dc (or average) error and some amount of ripple, as shown in Figure 18.



Figure 18. Typical Output Waveform for Sinusoidal Input

The dc error is dependent on the input signal frequency and the value of CAV. Use Figure 19 to determine the minimum value of CAV, which yields a given percentage of dc error above a given frequency using the standard rms connection.

The ac component of the output signal is the ripple. There are two ways to reduce the ripple. The first method involves using a large value of CAV. Because the ripple is inversely proportional to CAV, a tenfold increase in this capacitance affects a tenfold reduction in ripple.

When measuring waveforms with high crest factors, such as low duty cycle pulse trains, the averaging time constant should be at least 10 times the signal period. For example, a 100 Hz pulse rate requires a 100 ms time constant, which corresponds to a 4 μF capacitor (time constant = 25 ms per μF).

The primary disadvantage in using a large C_{AV} to remove ripple is that the settling time for a step change in input level is increased proportionately. Figure 19 illustrates that the relationship between C_{AV} and 1% settling time is 115 ms for each microfarad of C_{AV} . The settling time is twice as great for decreasing signals as it is for increasing signals. The values in Figure 19 are for decreasing signals. Settling time also increases for low signal levels, as shown in Figure 20.

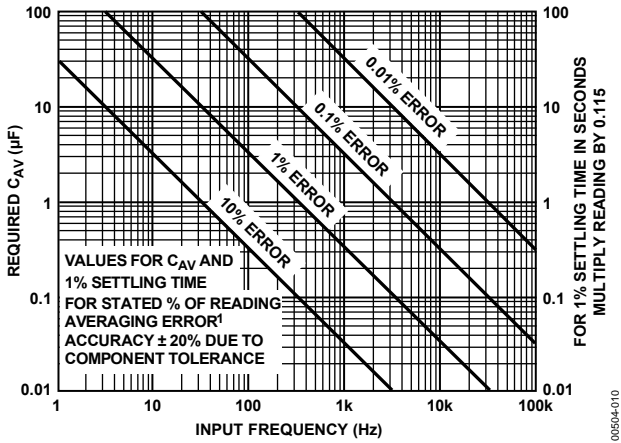

1PERCENT DC ERROR AND PERCENT RIPPLE (PEAK)
 Figure 19. Error/Settling Time Graph for Use with the Standard RMS Connection (See Figure 13 Through Figure 15)

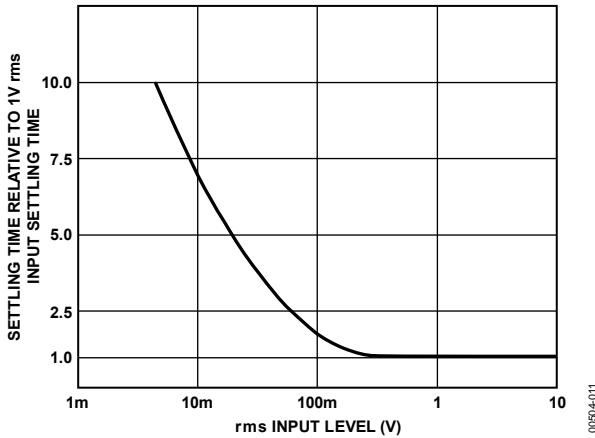

Figure 20. Settling Time vs. Input Level

A better method to reduce output ripple is the use of a postfilter. Figure 21 shows a suggested circuit. If a single-pole filter is used (C_3 removed, R_x shorted) and C_2 is approximately twice the value of C_{AV} , the ripple is reduced, as shown in Figure 22, and settling time is increased. For example, with $C_{AV} = 1 \mu\text{F}$ and $C_2 = 2.2 \mu\text{F}$, the ripple for a 60 Hz input is reduced from 10% of reading to approximately 0.3% of reading.

The settling time, however, is increased by approximately a factor of 3. Therefore, the values of C_{AV} and C_2 can be reduced to permit faster settling times while still providing substantial ripple reduction.

The two-pole postfilter uses an active filter stage to provide even greater ripple reduction without substantially increasing the settling times over a circuit with a one-pole filter. The values of C_{AV} , C_2 , and C_3 can then be reduced to allow extremely fast settling times for a constant amount of ripple. Caution should be exercised in choosing the value of C_{AV} , because the dc error is dependent on this value and is independent of the postfilter.

For a more detailed explanation of these topics, refer to the [RMS to DC Conversion Application Guide, 2nd Edition](#).

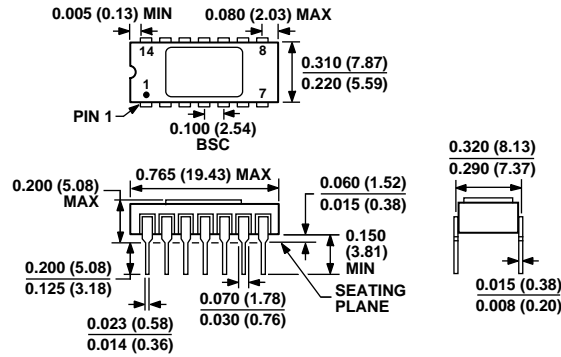

Figure 21. Two-Pole Postfilter



Figure 22. Performance Features of Various Filter Types (See Figure 13 to Figure 15 for Standard RMS Connection)

OUTLINE DIMENSIONS



CONTROLLING DIMENSIONS ARE IN INCHES; MILLIMETER DIMENSIONS (IN PARENTHESES) ARE ROUNDED-OFF INCH EQUIVALENTS FOR REFERENCE ONLY AND ARE NOT APPROPRIATE FOR USE IN DESIGN.

Figure 23. 14-Lead Side-Brazed Ceramic Dual In-Line Package [SBDIP] (D-14)

Dimensions shown in inches and (millimeters)

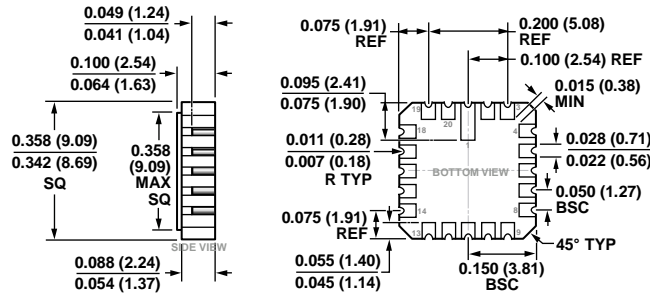

CONTROLLING DIMENSIONS ARE IN INCHES; MILLIMETER DIMENSIONS (IN PARENTHESES) ARE ROUNDED-OFF INCH EQUIVALENTS FOR REFERENCE ONLY AND ARE NOT APPROPRIATE FOR USE IN DESIGN.

Figure 24. 20-Terminal Ceramic Leadless Chip Carrier [LCC] (E-20-1)

Dimensions shown in inches and (millimeters)



CONTROLLING DIMENSIONS ARE IN INCHES; MILLIMETER DIMENSIONS (IN PARENTHESES) ARE ROUNDED-OFF INCH EQUIVALENTS FOR REFERENCE ONLY AND ARE NOT APPROPRIATE FOR USE IN DESIGN.

Figure 25. 14-Lead Ceramic Dual In-Line Package [CERDIP] (Q-14)

Dimensions shown in inches and (millimeters)



DIMENSIONS PER JEDEC STANDARDS MO-006-AF
 CONTROLLING DIMENSIONS ARE IN INCHES; MILLIMETER DIMENSIONS
 (IN PARENTHESES) ARE ROUNDED-OFF INCH EQUIVALENTS FOR
 REFERENCE ONLY AND ARE NOT APPROPRIATE FOR USE IN DESIGN.

01-19-2015A

Figure 26. 10-Pin Metal Header Package [TO-100]
 (H-10)

Dimensions shown in inches and (millimeters)

ORDERING GUIDE

Model ¹	Temperature Range	Package Description	Package Option
AD536AJD	0°C to +70°C	14-Lead Side-Brazed Ceramic Dual In-Line Package [SBDIP]	D-14
AD536AJDZ	0°C to +70°C	14-Lead Side-Brazed Ceramic Dual In-Line Package [SBDIP]	D-14
AD536AKDZ	0°C to +70°C	14-Lead Side-Brazed Ceramic Dual In-Line Package [SBDIP]	D-14
AD536AJH	0°C to +70°C	10-Pin Metal Header Package [TO-100]	H-10
AD536AJHZ	0°C to +70°C	10-Pin Metal Header Package [TO-100]	H-10
AD536AKHZ	0°C to +70°C	10-Pin Metal Header Package [TO-100]	H-10
AD536AJQ	0°C to +70°C	14-Lead Ceramic Dual In Line Package [CERDIP]	Q-14
AD536ASD	-55°C to +125°C	14-Lead Side-Brazed Ceramic Dual In-Line Package [SBDIP]	D-14
AD536ASD/883B	-55°C to +125°C	14-Lead Side-Brazed Ceramic Dual In-Line Package [SBDIP]	D-14
AD536ASE/883B	-55°C to +125°C	20-Terminal Ceramic Leadless Chip Carrier [LCC]	E-20-1
AD536ASH	-55°C to +125°C	10-Pin Metal Header Package [TO-100]	H-10
AD536ASH/883B	-55°C to +125°C	10-Pin Metal Header Package [TO-100]	H-10
AD536ASCHIPS	-55°C to +125°C	Die	
5962-89805012A	-55°C to +125°C	20-Terminal Ceramic Leadless Chip Carrier [LCC]	E-20-1
5962-8980501CA	-55°C to +125°C	14-Lead Side-Brazed Ceramic Dual In-Line Package [SBDIP]	D-14
5962-8980501IA	-55°C to +125°C	10-Pin Metal Header Package [TO-100]	H-10

¹ Z = RoHS Compliant Part.



Стандарт Электрон Связь

Мы молодая и активно развивающаяся компания в области поставок электронных компонентов. Мы поставляем электронные компоненты отечественного и импортного производства напрямую от производителей и с крупнейших складов мира.

Благодаря сотрудничеству с мировыми поставщиками мы осуществляем комплексные и плановые поставки широчайшего спектра электронных компонентов.

Собственная эффективная логистика и склад в обеспечивает надежную поставку продукции в точно указанные сроки по всей России.

Мы осуществляем техническую поддержку нашим клиентам и предпродажную проверку качества продукции. На все поставляемые продукты мы предоставляем гарантию .

Осуществляем поставки продукции под контролем ВП МО РФ на предприятия военно-промышленного комплекса России , а также работаем в рамках 275 ФЗ с открытием отдельных счетов в уполномоченном банке. Система менеджмента качества компании соответствует требованиям ГОСТ ISO 9001.

Минимальные сроки поставки, гибкие цены, неограниченный ассортимент и индивидуальный подход к клиентам являются основой для выстраивания долгосрочного и эффективного сотрудничества с предприятиями радиоэлектронной промышленности, предприятиями ВПК и научно-исследовательскими институтами России.

С нами вы становитесь еще успешнее!

Наши контакты:

Телефон: +7 812 627 14 35

Электронная почта: sales@st-electron.ru

Адрес: 198099, Санкт-Петербург,
Промышленная ул, дом № 19, литера Н,
помещение 100-Н Офис 331