

# MAXIM

## 1.25Ω, Dual SPST, CMOS Analog Switches

MAX4580/MAX4590/MAX4600

### General Description

The MAX4580/MAX4590/MAX4600 dual analog switches feature low on-resistance of 1.25Ω max. On-resistance is matched between switches to 0.25Ω max and is flat (0.3Ω max) over the specified signal range. Each switch can handle Rail-to-Rail® analog signals. The off-leakage current is only 2.5nA max at +85°C. These analog switches are ideal in low-distortion applications and are the preferred solution over mechanical relays in automatic test equipment or applications where current switching is required. They have low power requirements, require less board space, and are more reliable than mechanical relays.

The MAX4580 has two NC (normally closed) switches, the MAX4590 has two NO (normally open) switches, and the MAX4600 has one NC (normally closed) and one NO (normally open) switch.

These switches operate from a +4.5V to +36V single supply or from ±4.5V to ±20V dual supplies. All digital inputs have +0.8V and +2.4V logic thresholds, ensuring TTL/CMOS-logic compatibility when using a +12V single supply or ±15V dual supplies.

### Applications

- Reed Relay Replacement
- Test Equipment
- Communication Systems
- PBX, PABX Systems

### Features

- ◆ Low On-Resistance (1.25Ω max)
- ◆ Guaranteed R<sub>ON</sub> Match Between Channels (0.25Ω max)
- ◆ Guaranteed R<sub>ON</sub> Flatness Over Specified Signal Range (0.3Ω max)
- ◆ Rail-to-Rail Signal Handling
- ◆ Guaranteed ESD Protection >2kV per Method 3015.7
- ◆ Single-Supply Operation: +4.5V to +36V  
Dual-Supply Operation: ±4.5V to ±20V
- ◆ TTL/CMOS-Compatible Control Inputs

### Ordering Information

PART	TEMP RANGE	PIN-PACKAGE
MAX4580CAE	0°C to +70°C	16 SSOP
MAX4580CWE	0°C to +70°C	16 Wide SO
MAX4580CPE	0°C to +70°C	16 Plastic DIP
MAX4580EAE	-40°C to +85°C	16 SSOP
MAX4580EWE	-40°C to +85°C	16 Wide SO
MAX4580EPE	-40°C to +85°C	16 Plastic DIP

Ordering Information continued at end of data sheet.

### Pin Configurations/Functional Diagrams/Truth Tables

TOP VIEW

**MAX4580**

LOGIC	SWITCH
0	ON
1	OFF

**MAX4590**

LOGIC	SWITCH
0	OFF
1	ON

**MAX4600**

LOGIC	SWITCH 1	SWITCH 2
0	OFF	ON
1	ON	OFF

N.C. = NOT INTERNALLY CONNECTED

Rail-to-Rail is a registered trademark of Nippon Motorola, Ltd.



For pricing, delivery, and ordering information, please contact Maxim/Dallas Direct! at 1-888-629-4642, or visit Maxim's website at [www.maxim-ic.com](http://www.maxim-ic.com).

# 1.25Ω, Dual SPST, CMOS Analog Switches

## ABSOLUTE MAXIMUM RATINGS

V+ to GND .....	-0.3V to +44V	Continuous Power Dissipation (T <sub>A</sub> = +70°C)	
V- to GND .....	+0.3V to -44V	16 SSOP (derate 7.1mW/°C above +70°C) .....	571mW
V+ to V- .....	-0.3V to +44V	16 Wide SO (derate 9.52mW/°C above +70°C) .....	762mW
V <sub>L</sub> to GND .....	-0.3V to (V+ + 0.3V)	16 Plastic DIP (derate 10.53mW/°C above +70°C) .....	842mW
All Other Pins to GND (Note 1) .....	(V- - 0.3V) to (V+ + 0.3V)	Operating Temperature Ranges	
Continuous Current (COM <sub>-</sub> , NO <sub>-</sub> , NC <sub>-</sub> ) .....	±200mA	MAX4 <sub>-</sub> _OC_E .....	0°C to +70°C
Peak Current (COM <sub>-</sub> , NO <sub>-</sub> , NC <sub>-</sub> ) .....	±300mA	MAX4 <sub>-</sub> _OE_E .....	-40°C to +85°C
(pulsed at 1ms, 10% duty cycle) .....	±300mA	Storage Temperature Range .....	-65°C to +160°C
		Lead Temperature (soldering, 10sec) .....	+300°C

**Note 1:** Signals on NC<sub>-</sub>, NO<sub>-</sub>, COM<sub>-</sub>, or IN<sub>-</sub> exceeding V+ or V- are clamped by internal diodes. Limit forward diode current to maximum current rating.

Stresses beyond those listed under "Absolute Maximum Ratings" may cause permanent damage to the device. These are stress ratings only, and functional operation of the device at these or any other conditions beyond those indicated in the operational sections of the specifications is not implied. Exposure to absolute maximum rating conditions for extended periods may affect device reliability.

## ELECTRICAL CHARACTERISTICS—Dual Supplies

(V+ = +15V, V- = -15V, V<sub>L</sub> = +5V, V<sub>IN\_H</sub> = +2.4V, V<sub>IN\_L</sub> = +0.8V, T<sub>A</sub> = T<sub>MIN</sub> to T<sub>MAX</sub>, unless otherwise noted. Typical values are at T<sub>A</sub> = +25°C.)

PARAMETER	SYMBOL	CONDITIONS	MIN	TYP (Note 2)	MAX	UNITS	
<b>ANALOG SWITCH</b>							
Input Voltage Range (Note 3)	V <sub>COM<sub>-</sub></sub> , V <sub>NO<sub>-</sub></sub> , V <sub>NC<sub>-</sub></sub>		V-		V+	V	
COM <sub>-</sub> to NO <sub>-</sub> or NC <sub>-</sub> On-Resistance	R <sub>ON</sub>	I <sub>COM<sub>-</sub></sub> = 10mA, V <sub>NO<sub>-</sub></sub> or V <sub>NC<sub>-</sub></sub> = ±10V,		0.9	1.25	Ω	
		T <sub>A</sub> = +25°C T <sub>A</sub> = T <sub>MIN</sub> to T <sub>MAX</sub>			1.5		
COM <sub>-</sub> to NO <sub>-</sub> or NC <sub>-</sub> On-Resistance Match Between Channels (Note 4)	ΔR <sub>ON</sub>	I <sub>COM<sub>-</sub></sub> = 10mA, V <sub>NO<sub>-</sub></sub> or V <sub>NC<sub>-</sub></sub> = ±10V		0.05	0.25	Ω	
		T <sub>A</sub> = +25°C T <sub>A</sub> = T <sub>MIN</sub> to T <sub>MAX</sub>			0.5		
COM <sub>-</sub> to NO <sub>-</sub> or NC <sub>-</sub> On-Resistance Flatness (Note 5)	R <sub>FLAT(ON)</sub>	I <sub>COM<sub>-</sub></sub> = 10mA; V <sub>NO<sub>-</sub></sub> or V <sub>NC<sub>-</sub></sub> = -5V, 0, +5V		0.06	0.3	Ω	
		T <sub>A</sub> = +25°C T <sub>A</sub> = T <sub>MIN</sub> to T <sub>MAX</sub>			0.5		
Off-Leakage Current (NO <sub>-</sub> or NC <sub>-</sub> ) (Note 6)	I <sub>NO<sub>-</sub></sub> , I <sub>NC<sub>-</sub></sub>	V <sub>COM<sub>-</sub></sub> = ±10V, V <sub>NO<sub>-</sub></sub> or V <sub>NC<sub>-</sub></sub> = ∓10V		-0.5	0.01	0.5	nA
		T <sub>A</sub> = +25°C T <sub>A</sub> = T <sub>MIN</sub> to T <sub>MAX</sub>		-2.5		2.5	
COM <sub>-</sub> Off-Leakage Current (Note 6)	I <sub>COM<sub>-</sub>(OFF)</sub>	V <sub>COM<sub>-</sub></sub> = ±10V, V <sub>NO<sub>-</sub></sub> or V <sub>NC<sub>-</sub></sub> = ∓10V		-0.5	0.01	0.5	nA
		T <sub>A</sub> = +25°C T <sub>A</sub> = T <sub>MIN</sub> to T <sub>MAX</sub>		-2.5		2.5	
COM <sub>-</sub> On-Leakage Current (Note 6)	I <sub>COM<sub>-</sub>(ON)</sub>	V <sub>COM<sub>-</sub></sub> = ±10V, V <sub>NO<sub>-</sub></sub> or V <sub>NC<sub>-</sub></sub> = ±10V, or floating		-1	0.01	1	nA
		T <sub>A</sub> = +25°C T <sub>A</sub> = T <sub>MIN</sub> to T <sub>MAX</sub>		-5		5	
<b>LOGIC INPUT</b>							
Input Current with Input Voltage High	I <sub>IN_H</sub>	IN <sub>-</sub> = 2.4V, all others = 0.8V	-0.500	0.001	0.500	μA	
Input Current with Input Voltage Low	I <sub>IN_L</sub>	IN <sub>-</sub> = 0.8V, all others = 2.4V	-0.500	0.001	0.500		

# 1.25Ω, Dual SPST, CMOS Analog Switches

MAX4580/MAX4590/MAX4600

## ELECTRICAL CHARACTERISTICS—Dual Supplies (continued)

(V<sub>+</sub> = +15V, V<sub>-</sub> = -15V, V<sub>L</sub> = +5V, V<sub>IN\_H</sub> = +2.4V, V<sub>IN\_L</sub> = +0.8V, T<sub>A</sub> = T<sub>MIN</sub> to T<sub>MAX</sub>, unless otherwise noted. Typical values are at T<sub>A</sub> = +25°C.)

PARAMETER	SYMBOL	CONDITIONS	MIN	TYP (Note 2)	MAX	UNITS	
Logic Input High Voltage	V <sub>IN_H</sub>		2.4	1.7		V	
Logic Input Low Voltage	V <sub>IN_L</sub>			1.7	0.8	V	
<b>POWER SUPPLY</b>							
Power-Supply Range			±4.5		±20.0	V	
Positive Supply Current	I <sub>+</sub>	V <sub>IN_</sub> = 0 or +5V	T <sub>A</sub> = +25°C	-0.5	0.01	0.5	μA
			T <sub>A</sub> = T <sub>MIN</sub> to T <sub>MAX</sub>	5		5	
Negative Supply Current	I <sub>-</sub>	V <sub>IN_</sub> = 0 or +5V	T <sub>A</sub> = +25°C	-0.5	0.01	0.5	μA
			T <sub>A</sub> = T <sub>MIN</sub> to T <sub>MAX</sub>	5		5	
Logic Supply Current	I <sub>L</sub>	V <sub>IN_</sub> = 0 or +5V	T <sub>A</sub> = +25°C	-0.5	0.01	0.5	μA
			T <sub>A</sub> = T <sub>MIN</sub> to T <sub>MAX</sub>	5		5	
Ground Current	I <sub>GND</sub>	V <sub>IN_</sub> = 0 or +5V	T <sub>A</sub> = +25°C	-0.5	0.01	0.5	μA
			T <sub>A</sub> = T <sub>MIN</sub> to T <sub>MAX</sub>	5		5	
<b>SWITCH DYNAMIC CHARACTERISTICS</b>							
Turn-On Time	t <sub>ON</sub>	Figure 2, V <sub>COM_</sub> = ±10V, T <sub>A</sub> = +25°C		160		ns	
Turn-Off Time	t <sub>OFF</sub>	Figure 2, V <sub>COM_</sub> = ±10V, T <sub>A</sub> = +25°C		210		ns	
Charge Injection	Q	C <sub>L</sub> = 1.0nF, V <sub>GEN</sub> = 0, R <sub>GEN</sub> = 0, Figure 3, T <sub>A</sub> = +25°C		-60		pC	
Off-Isolation (Note 7)	V <sub>ISO</sub>	R <sub>L</sub> = 50Ω, C <sub>L</sub> = 5pF, f = 1MHz, Figure 4, T <sub>A</sub> = +25°C		-53		dB	
Crosstalk (Note 8)	V <sub>CT</sub>	R <sub>L</sub> = 50Ω, C <sub>L</sub> = 5pF, f = 1MHz, Figure 5, T <sub>A</sub> = +25°C		-65		dB	
NC_ or NO_ Capacitance	C <sub>(OFF)</sub>	f = 1MHz, Figure 6, T <sub>A</sub> = +25°C		115		pF	
COM Off-Capacitance	C <sub>(COM)</sub>	f = 1MHz, Figure 6, T <sub>A</sub> = +25°C		115		pF	
On-Capacitance	C <sub>(COM)</sub>	f = 1MHz, Figure 7, T <sub>A</sub> = +25°C		520		pF	

# 1.25Ω, Dual SPST, CMOS Analog Switches

## ELECTRICAL CHARACTERISTICS—Single Supply

(V+ = +12V, V- = 0, VL = +5V, VINH = 2.4V, VINL = 0.8V, TA = TMIN to TMAX, unless otherwise noted. Typical values are at TA = +25°C.)

PARAMETER	SYMBOL	CONDITIONS		MIN	TYP (Note 2)	MAX	UNITS
<b>ANALOG SWITCH</b>							
Input Voltage Range (Note 3)	VCOM_, VNO_, VNC_			GND		V+	V
COM_ to NO_ or NC_ On-Resistance	RON	I <sub>COM_</sub> = 10mA, V <sub>NO_</sub> or V <sub>NC_</sub> = +10V, V+ = 12V	TA = +25°C		1.6	3	Ω
			TA = TMIN to TMAX			3.5	
COM_ to NO_ or NC_ On-Resistance Match Between Channels (Note 4)	ΔRON	I <sub>COM_</sub> = 10mA, V <sub>NO_</sub> or V <sub>NC_</sub> = +10V	TA = +25°C			0.4	Ω
			TA = TMIN to TMAX			0.5	
COM_ to NO_ or NC_ On-Resistance Flatness (Note 5)	R <sub>FLAT(ON)</sub>	I <sub>COM_</sub> = 10mA; V <sub>NO_</sub> or V <sub>NC_</sub> = +3V, +6V, +9V	TA = +25°C			0.4	Ω
			TA = TMIN to TMAX			0.5	
Off-Leakage Current (NO_ or NC_) (Notes 6, 9)	I <sub>NO_</sub> , I <sub>NC_</sub>	V <sub>COM_</sub> = 1V, +10V; V <sub>NO_</sub> or V <sub>NC_</sub> = +10V, +1V	TA = +25°C	-0.5	0.01	0.5	nA
			TA = TMIN to TMAX	-2.5		2.5	
COM_ Off-Leakage Current (Notes 6, 9)	I <sub>COM_(OFF)</sub>	V <sub>NO_</sub> or V <sub>NC_</sub> = +10V, +1V; V <sub>COM_</sub> = +1V, +10V	TA = +25°C	-0.5	0.01	0.5	nA
			TA = TMIN to TMAX	-2.5		2.5	
COM_ On-Leakage Current (Notes 6, 9)	I <sub>COM_(ON)</sub>	V <sub>COM_</sub> = +1V, +10V; V <sub>NO_</sub> or V <sub>NC_</sub> = +1V, +10V, or floating	TA = +25°C	-1	0.02	1	nA
			TA = TMIN to TMAX	-10		10	
<b>LOGIC INPUT</b>							
Input Current with Input Voltage High	I <sub>IN_L</sub>	IN_ = 0.8V, all others = 2.4V		-0.500	0.001	0.500	μA
Input Current with Input Voltage Low	I <sub>IN_H</sub>	IN_ = 2.4V, all others = 0.8V		-0.500	0.001	0.500	μA
Logic Input High Voltage	V <sub>IN_H</sub>			2.4			V
Logic Input Low Voltage	V <sub>IN_L</sub>					0.8	V
<b>POWER SUPPLY</b>							
Power-Supply Range				+4.5		+36.0	V
Positive Supply Current	I+	V <sub>IN_</sub> = 0 or +5V	TA = +25°C	-0.5	0.001	0.5	μA
			TA = TMIN to TMAX	5		5	
Logic Supply Current	I <sub>L</sub>	V <sub>IN_</sub> = 0 or +5V	TA = +25°C	-0.5	0.001	0.5	μA
			TA = TMIN to TMAX	5		5	
Ground Current	I <sub>GND</sub>	V <sub>IN_</sub> = 0 or +5V	TA = +25°C	-0.5	0.001	0.5	μA
			TA = TMIN to TMAX	5		5	

# 1.25Ω, Dual SPST, CMOS Analog Switches

## ELECTRICAL CHARACTERISTICS—Single Supply (continued)

(V+ = +12V, V- = 0, VL = +5V, VIN\_H = 2.4V, VIN\_L = 0.8V, TA = TMIN to TMAX, unless otherwise noted. Typical values are at TA = +25°C.)

PARAMETER	SYMBOL	CONDITIONS	MIN	TYP (Note 2)	MAX	UNITS
<b>SWITCH DYNAMIC CHARACTERISTICS</b>						
Turn-On Time	tON	VCOM_ = +10V, Figure 2, TA = +25°C		150		ns
Turn-Off Time	tOFF	VCOM_ = +10V, Figure 2, TA = +25°C		200		ns
Charge Injection	Q	CL = 1.0nF, VGEN = 0, RGEN = 0, Figure 3, TA = +25°C		40		pC
Crosstalk (Note 8)	VCT	RL = 50Ω, CL = 5pF, f = 1MHz, Figure 5, TA = +25°C		-65		dB
NC_ or NO_ Capacitance	C(OFF)_	f = 1MHz, Figure 6, TA = +25°C		175		pF
COM Off-Capacitance	C(COM)_	f = 1MHz, Figure 6, TA = +25°C		175		pF
On-Capacitance	C(COM)_	f = 1MHz, Figure 7, TA = +25°C		275		pF

**Note 2:** The algebraic convention, where the most negative value is a minimum and the most positive value a maximum, is used in this data sheet.

**Note 3:** Guaranteed by design.

**Note 4:**  $\Delta R_{ON} = R_{ON(MAX)} - R_{ON(MIN)}$ .

**Note 5:** Flatness is defined as the difference between the maximum and minimum value of on-resistance as measured over the specified analog signal range.

**Note 6:** Leakage parameters are 100% tested at maximum-rated hot temperature and guaranteed by correlation at +25°C.

**Note 7:** Off-isolation =  $20 \log_{10} [V_{COM} / (V_{NC} \text{ or } V_{NO})]$ , VCOM = output, VNC or VNO = input to off switch.

**Note 8:** Between any two switches.

**Note 9:** Leakage testing at single supply is guaranteed by testing with dual supplies.

## Typical Operating Characteristics

(Circuit of Figure 1, TA = +25°C, unless otherwise noted.)

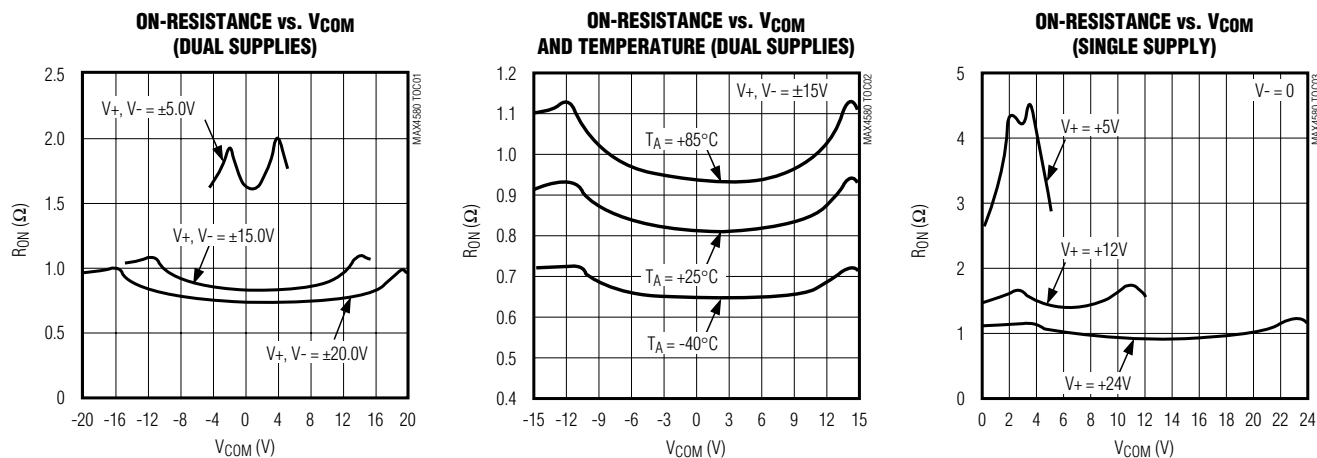

# 1.25Ω, Dual SPST, CMOS Analog Switches

## Typical Operating Characteristics (continued)

(Circuit of Figure 1,  $T_A = +25^\circ\text{C}$ , unless otherwise noted.)

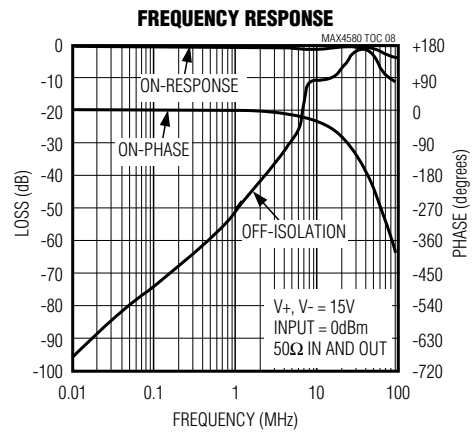
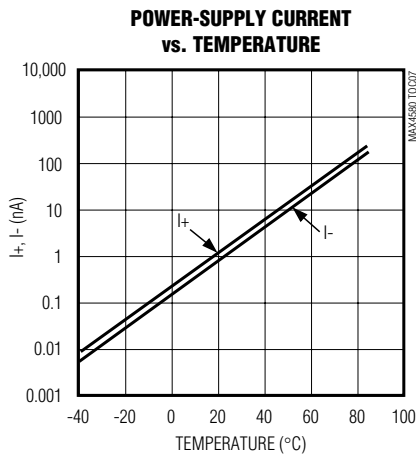
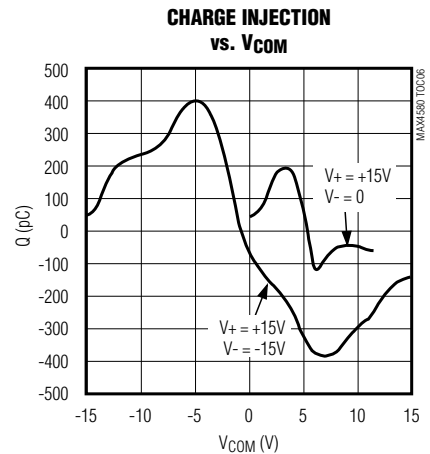
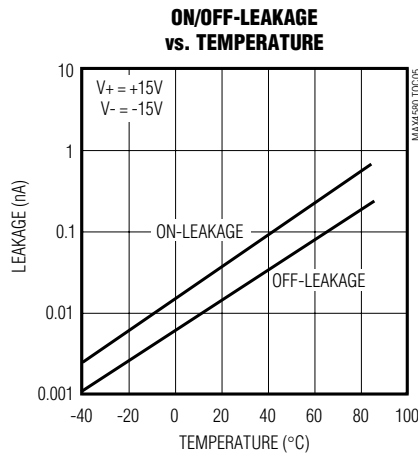
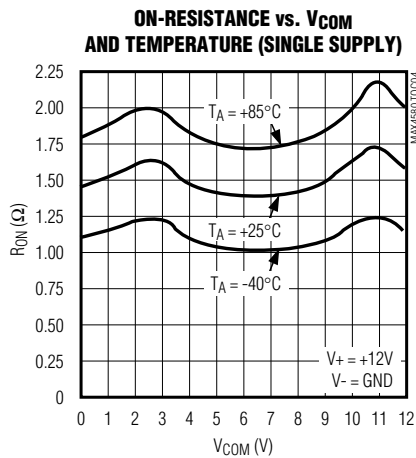

# 1.25Ω, Dual SPST, CMOS Analog Switches

## Typical Operating Characteristics (continued)

(Circuit of Figure 1,  $T_A = +25^\circ\text{C}$ , unless otherwise noted.)

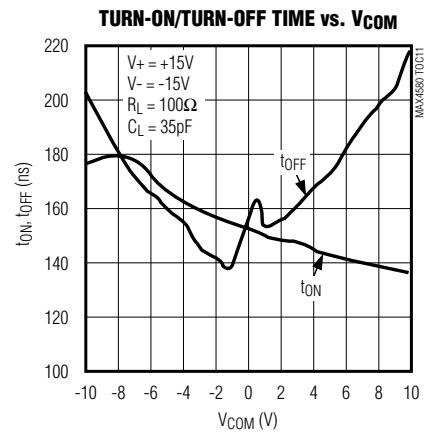

## Pin Description

PIN			NAME	FUNCTION
MAX4580	MAX4590	MAX4600		
1, 3, 6, 8, 10, 15	1, 3, 6, 8, 10, 15	1, 3, 6, 8, 10, 15	N.C.	No connection. Not internally connected. Connect to GND or low-impedance point to improve on/off-isolation.
2, 7	2, 7	2, 7	IN1, IN2	Logic-Control Digital Inputs
4	4	4	V-	Negative Analog Supply Voltage Input. Connect to GND for single-supply operation.
5	5	5	GND	Ground
12	12	12	$V_L$	Logic Supply Input
13	13	13	V+	Positive Analog Supply Input
14, 11	14, 11	14, 11	COM1, COM2	Analog Switch Common Terminals
16, 9	–	–	NC1, NC2	Analog Switch Normally Closed Terminals
–	16, 9	–	NO1, NO2	Analog Switch Normally Open Terminals
–	–	9	NC1	Analog Switch Normally Closed Terminal
–	–	16	NO1	Analog Switch Normally Open Terminal

# 1.25Ω, Dual SPST, CMOS Analog Switches

## Applications Information

### Overvoltage Protection

Proper power-supply sequencing is recommended for all CMOS devices. Do not exceed the absolute maximum ratings, because stresses beyond the listed ratings can cause permanent damage to the devices. Always sequence V+ on first, then V-, followed by the logic inputs, NO, or COM. If power-supply sequencing is not possible, add two small signal diodes (D1, D2) in series with supply pins for overvoltage protection (Figure 1). Adding diodes reduces the analog signal range to one diode drop below V+ and one diode drop above V-, but does not affect the devices' low switch resistance and low leakage characteristics. Device operation is unchanged, and the difference between V+ and V- should not exceed 44V. These protection diodes are not recommended when using a single supply.



Figure 1. Overvoltage Protection Using External Blocking Diodes

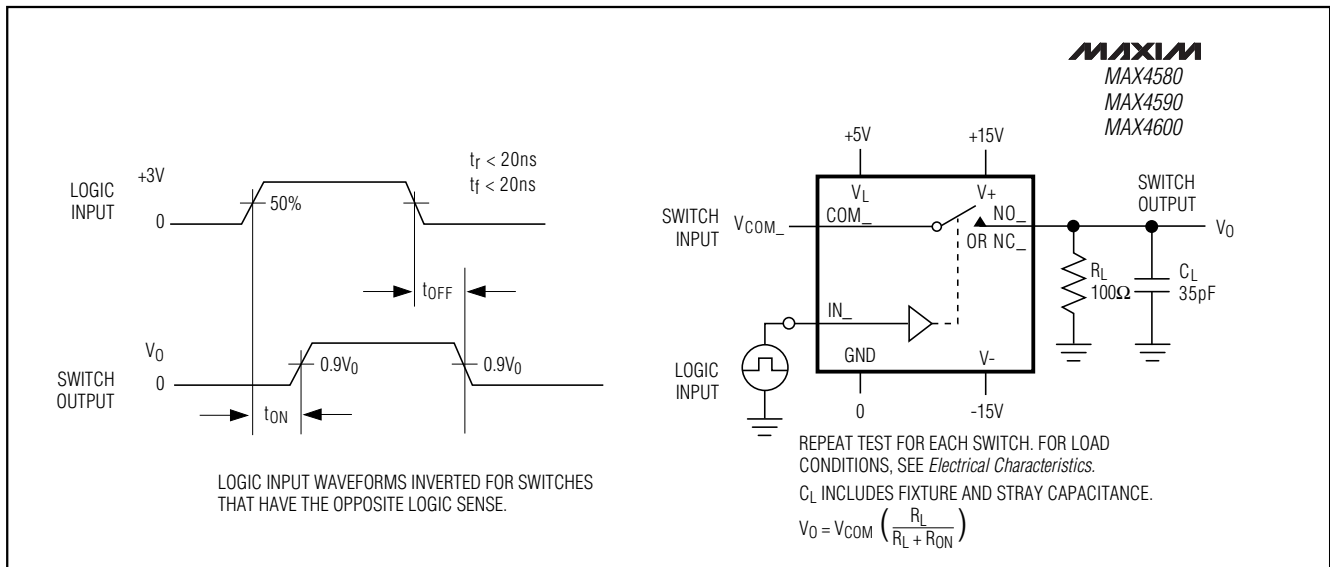

Figure 2. Switching-Time Test Circuit



# 1.25Ω, Dual SPST, CMOS Analog Switches

MAX4580/MAX4590/MAX4600



Figure 3. Charge-Injection Test Circuit



Figure 4. Off-Isolation Test Circuit



Figure 5. Crosstalk Test Circuit

# 1.25Ω, Dual SPST, CMOS Analog Switches

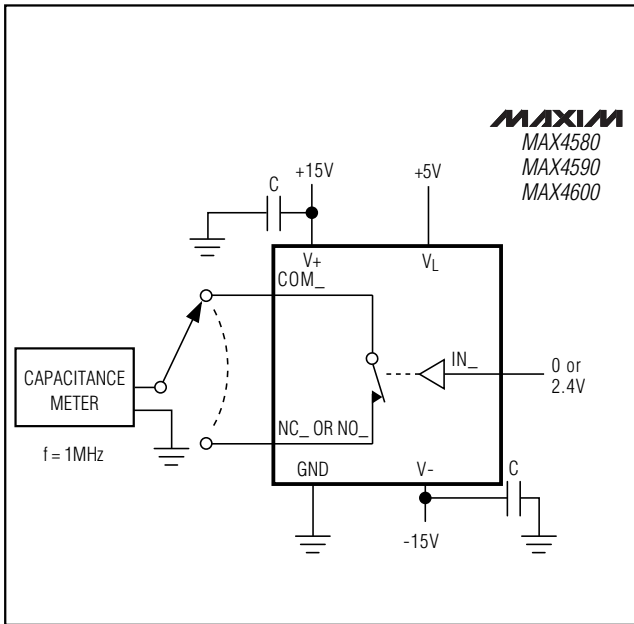

Figure 6. Switch Off-Capacitance Test Circuit



Figure 7. Switch On-Capacitance Test Circuit

## Ordering Information (continued)

PART	TEMP RANGE	PIN-PACKAGE
<b>MAX4590</b> CAE	0°C to +70°C	16 SSOP
MAX4590CWE	0°C to +70°C	16 Wide SO
MAX4590CPE	0°C to +70°C	16 Plastic DIP
MAX4590EAE	-40°C to +85°C	16 SSOP
MAX4590EWE	-40°C to +85°C	16 Wide SO
MAX4590EPE	-40°C to +85°C	16 Plastic DIP
<b>MAX4600</b> CAE	0°C to +70°C	16 SSOP
MAX4600CWE	0°C to +70°C	16 Wide SO
MAX4600CPE	0°C to +70°C	16 Plastic DIP
MAX4600EAE	-40°C to +85°C	16 SSOP
MAX4600EWE	-40°C to +85°C	16 Wide SO
MAX4600EPE	-40°C to +85°C	16 Plastic DIP

## Chip Information

TRANSISTOR COUNT: 100

# 1.25Ω, Dual SPST, CMOS Analog Switches

## Package Information

(The package drawing(s) in this data sheet may not reflect the most current specifications. For the latest package outline information go to [www.maxim-ic.com/packages](http://www.maxim-ic.com/packages).)

MAX4580/MAX4590/MAX4600

DIM	INCHES		MILLIMETERS	
	MIN	MAX	MIN	MAX
A	0.068	0.078	1.73	1.99
A1	0.002	0.008	0.05	0.21
B	0.010	0.015	0.25	0.38
C	0.004	0.008	0.09	0.20
D	SEE VARIATIONS			
E	0.205	0.212	5.20	5.38
e	0.0256 BSC		0.65 BSC	
H	0.301	0.311	7.65	7.90
L	0.025	0.037	0.63	0.95
α	0°	8°	0°	8°

D	INCHES		MILLIMETERS		N
	MIN	MAX	MIN	MAX	
D	0.239	0.249	6.07	6.33	14L
D	0.239	0.249	6.07	6.33	16L
D	0.278	0.289	7.07	7.33	20L
D	0.317	0.328	8.07	8.33	24L
D	0.397	0.407	10.07	10.33	28L

NOTES:

- D & E DO NOT INCLUDE MOLD FLASH.
- MOLD FLASH OR PROTRUSIONS NOT TO EXCEED .15 MM (.006").
- CONTROLLING DIMENSION: MILLIMETERS.
- MEETS JEDEC MO150.
- LEADS TO BE COPLANAR WITHIN 0.10 MM.

**DALLAS SEMICONDUCTOR** **MAXIM**

PROPRIETARY INFORMATION

TITLE: PACKAGE OUTLINE, SSOP, 5.3 MM

APPROVAL	DOCUMENT CONTROL NO. 21-0056	REV. C 1/1
----------	---------------------------------	------------

SSOP EP5

# 1.25Ω, Dual SPST, CMOS Analog Switches

## Package Information (continued)

(The package drawing(s) in this data sheet may not reflect the most current specifications. For the latest package outline information go to [www.maxim-ic.com/packages](http://www.maxim-ic.com/packages).)

TOP VIEW

FRONT VIEW

SIDE VIEW

DIM	INCHES		MILLIMETERS	
	MIN	MAX	MIN	MAX
A	0.093	0.104	2.35	2.65
A1	0.004	0.012	0.10	0.30
B	0.014	0.019	0.35	0.49
C	0.009	0.013	0.23	0.32
e	0.050		1.27	
E	0.291	0.299	7.40	7.60
H	0.394	0.419	10.00	10.65
L	0.016	0.050	0.40	1.27

VARIATIONS:

DIM	INCHES		MILLIMETERS		N	MS013
	MIN	MAX	MIN	MAX		
D	0.398	0.413	10.10	10.50	16	AA
D	0.447	0.463	11.35	11.75	18	AB
D	0.496	0.512	12.60	13.00	20	AC
D	0.598	0.614	15.20	15.60	24	AD
D	0.697	0.713	17.70	18.10	28	AE

NOTES:

1. D&E DO NOT INCLUDE MOLD FLASH.
2. MOLD FLASH OR PROTRUSIONS NOT TO EXCEED 0.15mm (.006").
3. LEADS TO BE COPLANAR WITHIN 0.10mm (.004").
4. CONTROLLING DIMENSION: MILLIMETERS.
5. MEETS JEDEC MS013.
6. N = NUMBER OF PINS.

<b>DALLAS SEMICONDUCTOR</b>		<b>MAXIM</b>	
PROPRIETARY INFORMATION			
TITLE:			
PACKAGE OUTLINE, .300" SOIC			
APPROVAL	DOCUMENT CONTROL NO.	REV.	1/1
	21-0042	B	

SOICWEP

Maxim cannot assume responsibility for use of any circuitry other than circuitry entirely embodied in a Maxim product. No circuit patent licenses are implied. Maxim reserves the right to change the circuitry and specifications without notice at any time.

12 **Maxim Integrated Products, 120 San Gabriel Drive, Sunnyvale, CA 94086 408-737-7600**



## Стандарт Электрон Связь

Мы молодая и активно развивающаяся компания в области поставок электронных компонентов. Мы поставляем электронные компоненты отечественного и импортного производства напрямую от производителей и с крупнейших складов мира.

Благодаря сотрудничеству с мировыми поставщиками мы осуществляем комплексные и плановые поставки широчайшего спектра электронных компонентов.

Собственная эффективная логистика и склад в обеспечивает надежную поставку продукции в точно указанные сроки по всей России.

Мы осуществляем техническую поддержку нашим клиентам и предпродажную проверку качества продукции. На все поставляемые продукты мы предоставляем гарантию .

Осуществляем поставки продукции под контролем ВП МО РФ на предприятия военно-промышленного комплекса России , а также работаем в рамках 275 ФЗ с открытием отдельных счетов в уполномоченном банке. Система менеджмента качества компании соответствует требованиям ГОСТ ISO 9001.

Минимальные сроки поставки, гибкие цены, неограниченный ассортимент и индивидуальный подход к клиентам являются основой для выстраивания долгосрочного и эффективного сотрудничества с предприятиями радиоэлектронной промышленности, предприятиями ВПК и научно-исследовательскими институтами России.

С нами вы становитесь еще успешнее!

### Наши контакты:

**Телефон:** +7 812 627 14 35

**Электронная почта:** [sales@st-electron.ru](mailto:sales@st-electron.ru)

**Адрес:** 198099, Санкт-Петербург,  
Промышленная ул, дом № 19, литера Н,  
помещение 100-Н Офис 331