

# Altech Corp.®

Serving the Automation & Control Industry since 1984



**Mechanical  
Thermostat**



**Panel Light**



**Panel Filters**



## Altech Panel Accessories



# LED Panel Light APL-Series

- Energy efficient LED technology
- Long life
- Magnet or Screw mounting
- Daisy chain (up to 10 lights)
- Maintenance-free
- On/off switch or motion sensor
- Wide Voltage Range (AC or DC)
- Integrated power unit



## Technical Details

Power Consumption	Max. 5W
Luminosity	290Lm at 120° / 870Lm at 360° (equals 75W light bulb)
LED Type	Angle of radiation 120°, light color: daylight, color temperature: 8,500k
Life Expectancy	60,000h at 68°F (20°C)
Connection	2-pole connector with snap lock
AC	Max. 2.5A / 240VAC, color: white connector
DC	Max. 2.5A / 60VDC, color: blue connector
Housing	Plastic, transparent
Operating Temperature	-22° to 140°F (-30°C to 60°C)
Operating Humidity	Max. 80% RH (non-condensing)
Protection Type / Class	IP20

## Attachment Method-Magnet

Part No.	Operating Voltage	Switch Type	Weight
APL-M120ACLS	100-240VAC, 50/60Hz (min. 90VAC, max. 265VAC)	on/off switch	7oz (.44lbs)
APL-M24DCLS	24-48VDC (min. 20VDC, max. 60VDC)	on/off switch	7oz (.44lbs)
APL-M120ACMS	100-240VAC, 50/60Hz (min. 90VAC, max. 265VAC)	motion sensor	7oz (.44lbs)
APL-M24DCMS	24-48VDC (min. 20VDC, max. 60VDC)	motion sensor	7oz (.44lbs)

## Attachment Method-Screw

Part No.	Operating Voltage	Switch Type	Weight
APL-S120ACLS	100-240VAC, 50/60Hz (min. 90VAC, max. 265VAC)	on/off switch	7oz (.44lbs)
APL-S24DCLS	24-48VDC (min. 20VDC, max. 60VDC)	on/off switch	7oz (.44lbs)
APL-S120ACMS	100-240VAC, 50/60Hz (min. 90VAC, max. 265VAC)	motion sensor	7oz (.44lbs)
APL-S24DCMS	24-48VDC (min. 20VDC, max. 60VDC)	motion sensor	7oz (.44lbs)

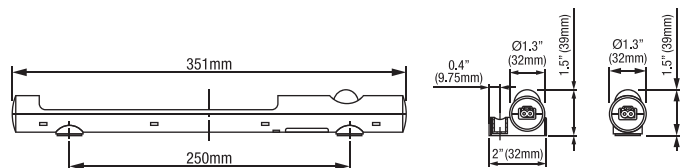
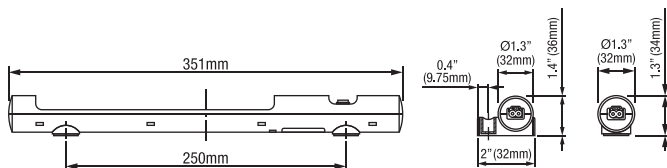



# Panel Filters



- Mounts Quickly and Easily - no mounting hardware required
- Low external Profile
- UV & Heat resisting Housing material
- Black or Grey Housing Color
- Filtering Class: G3 according to EN779
- Filtration Efficiency: 85% (DIN24185)
- Filter Mat included



## Exhaust Grills

Part No. Grey (RAL7035)	Part No. Black (RAL9005)	Dust Retention Capacity	Cutout Dimensions	Outer Dimensions
AEG-1000G	AEG-1000B	1.96oz/ft <sup>2</sup>	3.62"x3.62"	4.2"x4.2"x0.9"
AEG-2000G	AEG-2000B	1.96oz/ft <sup>2</sup>	4.92"x4.92"	5.9"x5.9"x1.1"
AEG-3000G	AEG-3000B	1.96oz/ft <sup>2</sup>	6.97"x6.97"	8.0"x8.0"x1.2"
AEG-4000G	AEG-4000B	1.96oz/ft <sup>2</sup>	8.78"x8.78"	9.8"x9.8"x1.3"
AEG-5000G	AEG-5000B	1.96oz/ft <sup>2</sup>	11.46"x11.46"	12.8"x12.8"x1.3"

## Filter Fans | 115VAC\*

Part No. Grey (RAL7035)	Part No. Black (RAL7035)	Rated Voltage	Rated Current @ 50/60Hz	Power Usage @ 50/ 60Hz	Max. Airflow	Fan Noise	Static Pressure	Cutout Dimensions
AFF-1010G-120VAC	AFF-1010B-120VAC	115VAC	0.11/ 0.09A	9/ 7W	7/ 9CFM	33dB(A)	0.13inH <sub>2</sub> O	3.62"x3.62"
AFF-1020G-120VAC	AFF-1020B-120VAC	115VAC	0.15/ 0.13A	12/ 10W	13/ 15CFM	42dB(A)	0.23inH <sub>2</sub> O	3.62"x3.62"
AFF-2010G-120VAC	AFF-2010B-120VAC	115VAC	0.20/ 0.18A	16/ 15W	26/ 29CFM	49dB(A)	0.33inH <sub>2</sub> O	4.92"x4.92"
AFF-2020G-120VAC	AFF-2020B-120VAC	115VAC	0.25/ 0.22A	19/ 17W	39/ 46CFM	44dB(A)	0.35inH <sub>2</sub> O	4.92"x4.92"
AFF-3010G-120VAC	AFF-3010B-120VAC	115VAC	0.21/ 0.20A	19/ 18W	59/ 65CFM	49dB(A)	0.24inH <sub>2</sub> O	6.97"x6.97"
AFF-3020G-120VAC	AFF-3020B-120VAC	115VAC	0.20/ 0.18A	16/ 15W	65/ 76CFM	44dB(A)	0.40inH <sub>2</sub> O	6.97"x6.97"
AFF-4010G-120VAC	AFF-4010B-120VAC	115VAC	0.21/ 0.21A	17/ 16W	62/ 70CFM	49dB(A)	0.23inH <sub>2</sub> O	8.78"x8.78"
AFF-4020G-120VAC	AFF-4020B-120VAC	115VAC	0.28/ 0.26A	31/ 26W	133/ 169CFM	55dB(A)	0.84inH <sub>2</sub> O	8.78"x8.78"
AFF-5010G-120VAC	AFF-5010B-120VAC	115VAC	0.68/ 0.73A	74/ 83W	306/ 359CFM	69dB(A)	0.78inH <sub>2</sub> O	11.46"x11.46"

\* 230VAC version available, please contact Altech for availability

## Filter Fans | 24VDC

Part No. Grey (RAL7035)	Part No. Black (RAL7035)	Rated Voltage	Rated Current	Power Usage	Max. Airflow	Fan Noise	Static Pressure	Cutout Dimensions
AFF-1010G-24VDC	AFF-1010B-24VDC	24VAC	0.09A	2W	9CFM	30dB(A)	0.11inH <sub>2</sub> O	3.62"x3.62"
AFF-1020G-24VDC	AFF-1020B-24VDC	24VAC	0.61A	15W	29CFM	59dB(A)	0.64inH <sub>2</sub> O	3.62"x3.62"
AFF-2010G-24VDC	AFF-2010B-24VDC	24VAC	0.31A	7W	27CFM	42dB(A)	0.23inH <sub>2</sub> O	4.92"x4.92"
AFF-3010G-24VDC	AFF-3010B-24VDC	24VAC	0.34A	8W	60CFM	42dB(A)	0.24inH <sub>2</sub> O	6.97"x6.97"
AFF-4010G-24VDC	AFF-4010B-24VDC	24VAC	0.32A	8W	82CFM	42dB(A)	0.25inH <sub>2</sub> O	6.97"x6.97"
AFF-4020G-24VDC	AFF-4020B-24VDC	24VAC	0.71A	17W	132CFM	58dB(A)	0.26inH <sub>2</sub> O	8.78"x8.78"



# Mechanical Thermostats

The APT Altech Mechanical Panel Thermostats are designed to control the air temperature inside of enclosures and control panels. They can be used for enclosure heaters, cooling equipment (e.g. filter fans), or signal devices.



- Adjustable Temperature Control
- Wide Adjustment Range
- Color Coded Dial (Red: Heating, Blue: Cooling)
- DIN Rail Mountable



The **Heating version** (red dial, NC) has closed contacts when the temperature is below the set point value and opens with rising temperature.

The **Cooling version** (blue dial, NO) has open contacts when the temperature is below the set point value and closes with rising temperature.

## Technical Details

Rated Voltage	110 - 250 VAC
Rated Current	10A
Max. Rated Current	15A
Hysteresis	+/-3K
Differential	-3°K NC version / +4°K NO version up to 5A / +7°K NC version > 5A
Lifetime	> 100,000 cycles
Terminal Size Acceptability	23 - 13 AWG (0.75 - 2.5mm <sup>2</sup> )
Protection Level	IP20
Enclosure Material	PA66, UL94V-0
Weight	1.9oz. (54g)

## Mechanical Thermostats

Part No.	Function	Contact	Temperature Scale	Setting Range
APT-HNCF	Heating	NC	Fahrenheit	14 - 176°F
APT-CNOF	Cooling	NO	Fahrenheit	14 - 176°F
APT-HNCC	Heating	NC	Celsius	-10 - 80°C
APT-CNOC	Cooling	NO	Celsius	-10 - 80°C

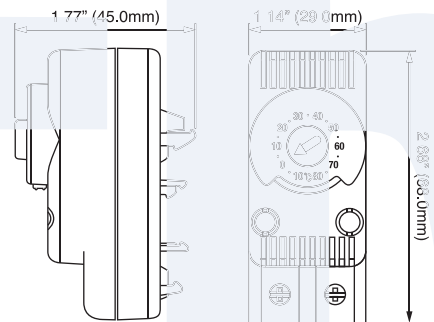

Thermostat Dimensions

# Lighting Accessories

## Power cable with female connector

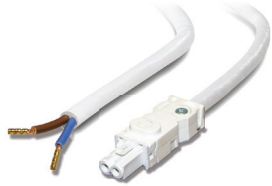

Part No.	Length	Volt. Type	Color
APL-PCAC	6.5 ft.	AC	Connector: white; Cable: white
APL-PCDC	6.5 ft.	DC	Connector: blue; Cable: white

## Extension cable with 2 connectors for daisy chain



Part No.	Length	Volt. Type	Color
APL-ECAC	3.3 ft.	AC	Connector: white; Cable: white
APL-ECDC	3.3 ft.	DC	Connector: blue; Cable: white

## Female / Male Connectors



Part No.	Connector Type	Volt. Type	Color
APL-FAC	Female	AC	White
APL-MAC	Male	AC	White
APL-FDC	Female	DC	Blue
APL-MDC	Male	DC	Blue

## Door Limit Switch



Part No.	Contact	Voltage Rating
APL-DS	NO / NC	24-250 VAC/DC
APL-SL	Slide limit switch (Bar mounting)	

# Filter Fan Accessories

## Replacement Filter Mats



- Made of washable non-woven synthetic fibers
- Can be cleaned up to 10 times by washing or blowing dry
- Black or Grey Housing Color
- NEMA 12 or NEMA 3R Filter Class available
- Sold in kits of 6pcs

Part No.	Filter Rating	Used with Filter Fan	Used with Exhaust Grill	Dimensions
AFM-1012	NEMA12	AFF-10xx	AEG-1000	3.3"x3.3"
AFM-2012	NEMA12	AFF-20xx	AEG-2000	4.6"x4.6"
AFM-3012	NEMA12	AFF-30xx	AEG-3000	6.6"x6.6"
AFM-4012	NEMA12	AFF-40xx	AEG-4000	8.5"x8.5"
AFM-5012	NEMA12	AFF-50xx	AEG-5000	11.1"x11.1"



### Altech Search

- Home
- Stock Check
- Distributors
- Information
- News
- Contact
- Rep/Disti Login
- Altech Mexico

### WEB TOOLS

- Product Crossings
- Request for Quote
- Sample Request
- Catalog Request

### PRODUCT MENU

Circuit Protection / Control

Connectors

Enclosures

European Spare Parts

Digital Panel Meters

Foot Switches

Interface Modules

Power Supplies

Power Semi-Conductors

Programmable Controllers

Push Buttons & Pilot Lights

Relays

Sensors

Terminal Blocks

Tower Lights

Timers

Wire & Cable Management

Home

### New Products and Promotions

## Serving the Automation & Control Industry Since 1984

### Circuit Protection



Circuit Protection Devices



Busbar and Power Distribution



Contactors, Overload Relays, Manual Motor Starters



Motor Disconnect Switches



European Fuses

### Connectors



Industrial Rectangular Connectors



Pin & Sleeve Devices



Receptacles

### Foot Switches



Foot Switches

### Sensors



Inductive Proximity Sensors

### Enclosures

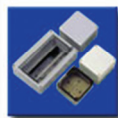

Industrial Enclosures



DIN Enclosures

### Modules & Relays

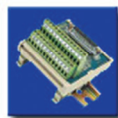

Interface Modules



Safety Relays



Slimline Relays

### Power Supplies



Power Supplies

### Push Buttons



22 & 30 mm Push Buttons

### DIN Rail



DIN Rail

### Wire & Cable Management



Liquid Tight Strain Reliefs/Corrugated Tubes



Wire Duct

### Terminal Blocks



Din Rail Terminal Blocks



Panel Mount Terminal Blocks

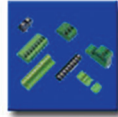

Printed Circuit Board Terminal Blocks



Eurostrips®



Distribution Blocks

### Miscellaneous



Ferrules

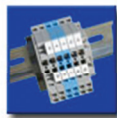

Custom Assembly

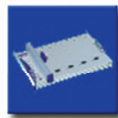

Marking & Engraving Systems



Altech Smart Relay



Tower Lights

Altech Corporation  
35 Royal Road  
Flemington, NJ 08822-6000  
P 908.806.9400 • F 908.806.9490  
www.altechcorp.com





## Стандарт Электрон Связь

Мы молодая и активно развивающаяся компания в области поставок электронных компонентов. Мы поставляем электронные компоненты отечественного и импортного производства напрямую от производителей и с крупнейших складов мира.

Благодаря сотрудничеству с мировыми поставщиками мы осуществляем комплексные и плановые поставки широчайшего спектра электронных компонентов.

Собственная эффективная логистика и склад в обеспечивает надежную поставку продукции в точно указанные сроки по всей России.

Мы осуществляем техническую поддержку нашим клиентам и предпродажную проверку качества продукции. На все поставляемые продукты мы предоставляем гарантию .

Осуществляем поставки продукции под контролем ВП МО РФ на предприятия военно-промышленного комплекса России , а также работаем в рамках 275 ФЗ с открытием отдельных счетов в уполномоченном банке. Система менеджмента качества компании соответствует требованиям ГОСТ ISO 9001.

Минимальные сроки поставки, гибкие цены, неограниченный ассортимент и индивидуальный подход к клиентам являются основой для выстраивания долгосрочного и эффективного сотрудничества с предприятиями радиоэлектронной промышленности, предприятиями ВПК и научно-исследовательскими институтами России.

С нами вы становитесь еще успешнее!

### Наши контакты:

**Телефон:** +7 812 627 14 35

**Электронная почта:** [sales@st-electron.ru](mailto:sales@st-electron.ru)

**Адрес:** 198099, Санкт-Петербург,  
Промышленная ул, дом № 19, литера Н,  
помещение 100-Н Офис 331