

## IEC Appliance Inlet C8 with Filter, Front Side Mounting

Standard- or Medical-Filter



new



Snap-in mounting from front side

Screw-on mounting from front side

C8  
  
70° C

**Description**

- Panel Mount:  
Screw-on or snap-in mounting from front side
- 2 Functions:  
Appliance Inlet Protection class II, Line filter in standard and medical version
- Solder terminals or quick connect terminals

**Approvals**

- VDE Certificate Number: 40029278
- UL File Number: E72928

**Characteristics**

- Compact high performance filter
- Designed for standard and medical applications
- Qualified for use in equipment according IEC/EN 60950

**Other versions on request**

- Standard version without X-capacitor

**Weblinks**

[pdf-datasheet](#), [html-datasheet](#), [General Product Information](#), [Approvals](#), [CE declaration of conformity](#), [RoHS](#), [CHINA-RoHS](#), [Mating Connectors](#), [e-Shop](#), [SCHURTER-Stock-Check](#), [Distributor-Stock-Check](#), [CAD-Drawings](#), [Accessories](#), [Detailed request for product](#)

**Technical Data**

Ratings IEC	0.5 - 2.5A @ Ta 40 °C / 250VAC; 50Hz	Appliance-Inlet/-Outlet	C8 acc. to IEC 60320
Ratings UL/CSA	0.5 - 6A @ Ta 40 °C / 250VAC; 60Hz	Line Filter	UL 498, CSA C22.2 no. 42 (for cold conditions) pin-temperature 70 °C, 2.5A, Protection Class II
Dielectric Strength	> 1.7kVDC between L-N > 4kVDC between L/N-PE Test voltage (2 sec)	MTBF	Standard and Medical Version, IEC 60939, IEC 60601-1, UL 1283, UL 544, CSA C22.2 no. 8 <a href="#">Technical Details</a>
Impulse Withstand Voltage	> 2.5 kV between L-N		
Allowable Operation Temp.	-25 °C to 85 °C		
Climatic Category	25/085/21 acc. to IEC 60068-1		
Degree of Protection	from front side IP 40 acc. to IEC 60529		
Protection Class	Suitable for appliances with protection class II acc. to IEC 61140		
Terminal	solder pin or quick connect terminals 6.3 x 0.8 or 4.8 x 0.8 mm		
Panel Thickness s	Screw Mounting screw torque max 0.5Nm Snap-in 1 mm to 3 mm		
Material: Housing	Thermoplastic, black, UL 94V-0		

**Dimensions**

Screw-on mounting from front side

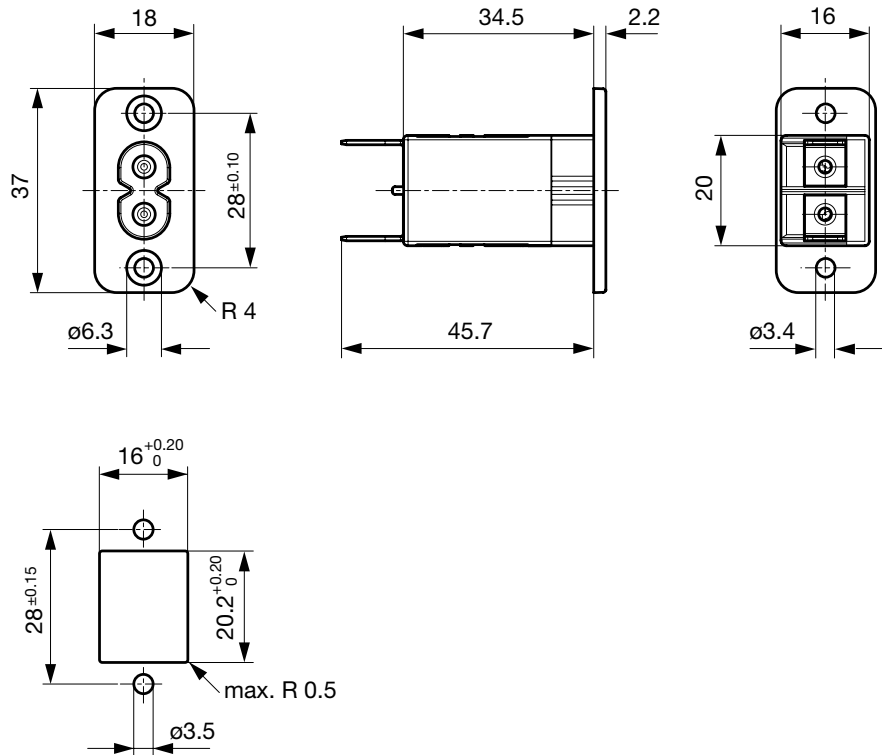

Snap-in mounting from front side

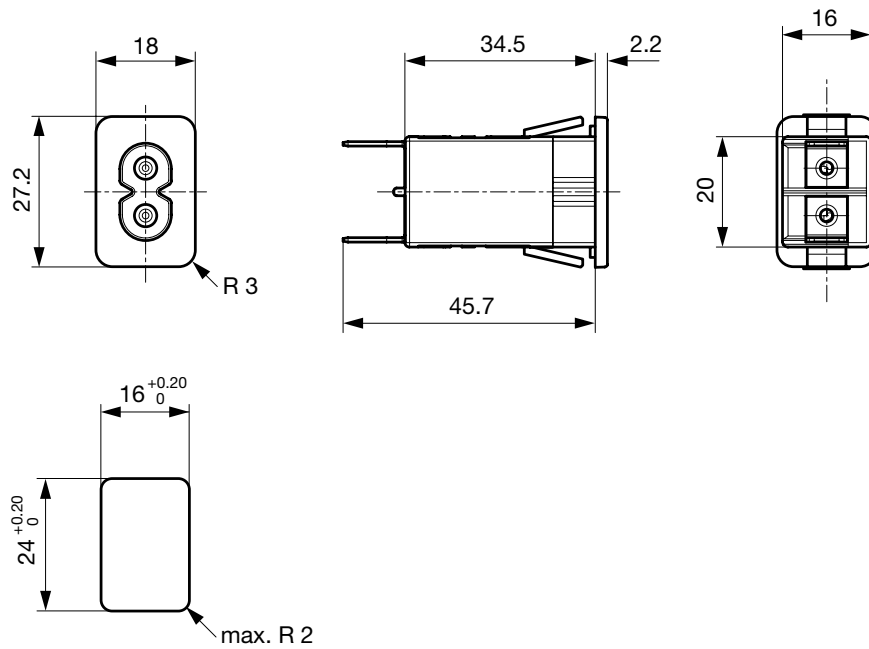

**Technical Data of Filter-Components**

Rated Current [A]	Filter-Type	Inductances L [mH]	Capacitance CX [nF]	Capacitance CY [nF]	R [MΩ]
1	Standard Version without Cx	2 x 8	-	-	-
0.5	Standard Version	2 x 18	100	-	-
1	Standard Version	2 x 8	100	-	-
2.5	Standard Version	2 x 1.2	100	-	-
4	Standard Version	2 x 0.8	100	-	-
6	Standard Version	2 x 0.3	100	-	-
0.5	Medical Version (M5)	2 x 18	100	-	1
1	Medical Version (M5)	2 x 8	100	-	1
2.5	Medical Version (M5)	2 x 1.2	100	-	1
4	Medical Version (M5)	2 x 0.8	100	-	1
6	Medical Version (M5)	2 x 0.3	100	-	1

**Diagrams**

Standard version

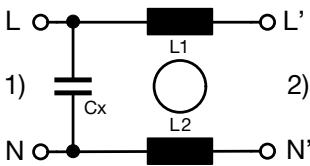

1) Line  
2) Load

Medical version M5

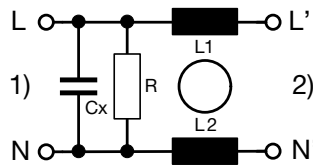

1) Line  
2) Load

**Derating Curves**

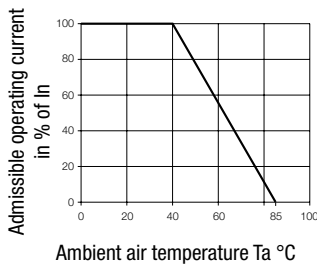

### Attenuation Loss

Standard version

--- differential mode    \_\_\_\_ common mode

0.5 A

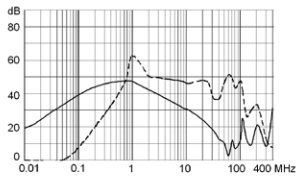

1 A

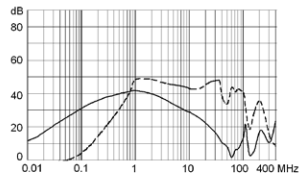

2.5 A

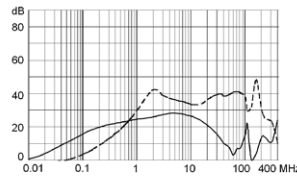

4 A

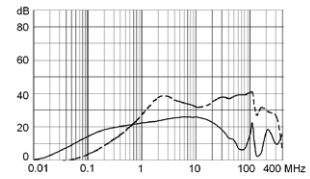

6 A

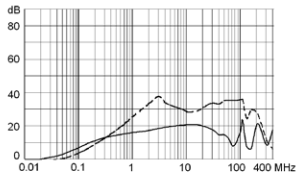

Medical version (M5)

0.5 A

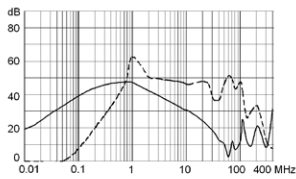

1 A

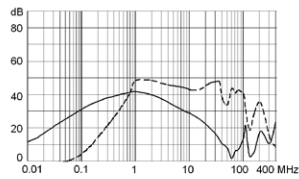

2.5 A

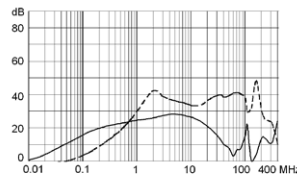

4 A

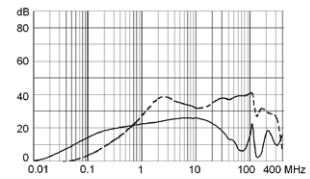

6 A

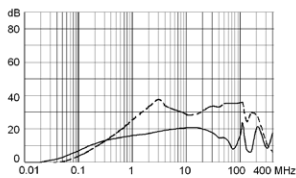

### Variants

Rated Current [A]	Filter-Type	Mounting	Terminal	Order Number
1	Standard Version without Cx	Snap-in 1.5	Quick connect terminal 4.8 x 0.8 mm	5008.2211
0.5	Standard Version	Snap-in 1.0	Quick connect terminal 4.8 x 0.8 mm	5008.1010
0.5	Standard Version	Snap-in 1.5	Quick connect terminal 4.8 x 0.8 mm	5008.2010
1	Standard Version	Snap-in 1.5	Solder terminal	5008.2021
1	Standard Version	Snap-in 1.5	Quick connect terminal 6.3 x 0.8 mm	5008.2001
1	Standard Version	Snap-in 2.0	Quick connect terminal 4.8 x 0.8 mm	5008.3011
2.5	Standard Version	Snap-in 1.0	Quick connect terminal 4.8 x 0.8 mm	5008.1012
2.5	Standard Version	Snap-in 1.5	Solder terminal	5008.2022
2.5	Standard Version	Snap-in 1.5	Quick connect terminal 4.8 x 0.8 mm	5008.2012
2.5	Standard Version	Snap-in 2.0	Solder terminal	5008.3022
2.5	Standard Version	Snap-in 2.0	Quick connect terminal 6.3 x 0.8 mm	5008.3002

Rated Current [A]	Filter-Type	Mounting	Terminal	Order Number
2.5	Standard Version	Screw	Solder terminal	5008.0022
2.5	Standard Version	Screw	Quick connect terminal 6.3 x 0.8 mm	5008.0002
2.5	Standard Version	Screw	Quick connect terminal 4.8 x 0.8 mm	5008.0012
4	Standard Version	Snap-in 1.5	Quick connect terminal 4.8 x 0.8 mm	5008.2014
6	Standard Version	Snap-in 1.0	Quick connect terminal 4.8 x 0.8 mm	5008.1016
6	Standard Version	Snap-in 1.5	Quick connect terminal 4.8 x 0.8 mm	5008.2016
6	Standard Version	Screw	Quick connect terminal 6.3 x 0.8 mm	5008.0006
0.5	Medical Version (M5)	Snap-in 1.0	Quick connect terminal 4.8 x 0.8 mm	5008.1110
1	Medical Version (M5)	Snap-in 1.0	Quick connect terminal 4.8 x 0.8 mm	5008.1111
1	Medical Version (M5)	Snap-in 2.0	Quick connect terminal 4.8 x 0.8 mm	5008.3111
1	Medical Version (M5)	Screw	Quick connect terminal 4.8 x 0.8 mm	5008.0111
2.5	Medical Version (M5)	Snap-in 1.0	Quick connect terminal 4.8 x 0.8 mm	5008.1112
2.5	Medical Version (M5)	Snap-in 2.0	Quick connect terminal 6.3 x 0.8 mm	5008.3102
4	Medical Version (M5)	Snap-in 1.0	Quick connect terminal 4.8 x 0.8 mm	5008.1114
4	Medical Version (M5)	Snap-in 1.5	Quick connect terminal 4.8 x 0.8 mm	5008.2114
6	Medical Version (M5)	Snap-in 1.0	Quick connect terminal 4.8 x 0.8 mm	5008.1116
6	Medical Version (M5)	Snap-in 1.5	Quick connect terminal 4.8 x 0.8 mm	5008.2116

Packaging unit 20 Pcs

Mating Outlets/Connectors

Category / Description



Appliance Outlet Overview complete

IEC Appliance Outlet D, Screw-on Mounting, Front or Rear Side, Solder Terminal	5082
--	------

Appliance Outlet further types to 5008



Connector Overview complete

IEC Appliance Outlet D, Inlay Mounting, Solder Terminal	5081
IEC Appliance Outlet D, Screw-on Mounting, Front Side, Solder Terminal	5084
IEC Appliance Outlet D, insert Mounting, Solder Terminal	5086

Connector further types to 5008



Power Cord Overview complete

Power Cord with IEC Connector C7, Straight 70°C	2510
Power Cord with IEC Connector C7, Angled	2511
Power Cord with IEC Plug C7, Angled	2514
Power Cord with IEC Connector C7, Straight 70°C	4810

Power Cord further types to 5008



## Стандарт Электрон Связь

Мы молодая и активно развивающаяся компания в области поставок электронных компонентов. Мы поставляем электронные компоненты отечественного и импортного производства напрямую от производителей и с крупнейших складов мира.

Благодаря сотрудничеству с мировыми поставщиками мы осуществляем комплексные и плановые поставки широчайшего спектра электронных компонентов.

Собственная эффективная логистика и склад в обеспечивает надежную поставку продукции в точно указанные сроки по всей России.

Мы осуществляем техническую поддержку нашим клиентам и предпродажную проверку качества продукции. На все поставляемые продукты мы предоставляем гарантию .

Осуществляем поставки продукции под контролем ВП МО РФ на предприятия военно-промышленного комплекса России , а также работаем в рамках 275 ФЗ с открытием отдельных счетов в уполномоченном банке. Система менеджмента качества компании соответствует требованиям ГОСТ ISO 9001.

Минимальные сроки поставки, гибкие цены, неограниченный ассортимент и индивидуальный подход к клиентам являются основой для выстраивания долгосрочного и эффективного сотрудничества с предприятиями радиоэлектронной промышленности, предприятиями ВПК и научно-исследовательскими институтами России.

С нами вы становитесь еще успешнее!

### Наши контакты:

**Телефон:** +7 812 627 14 35

**Электронная почта:** [sales@st-electron.ru](mailto:sales@st-electron.ru)

**Адрес:** 198099, Санкт-Петербург,  
Промышленная ул, дом № 19, литера Н,  
помещение 100-Н Офис 331