

Features

- $BV_{CE0} > 45V$
- $I_C = 100mA$ High Collector Current
- $P_D = 925mW$ Power Dissipation
- $0.36mm^2$ Package Footprint, 40% Smaller than DFN1006
- 0.4mm Height Package Minimizing Off-Board Profile
- Complementary PNP Type BC857BZ
- **Totally Lead-Free & Fully RoHS Compliant (Notes 1 & 2)**
- **Halogen and Antimony Free. "Green" Device (Note 3)**

Mechanical Data

- Case: X2-DFN0606-3
- Case Material: Molded Plastic, "Green" Molding Compound, UL Flammability Classification Rating 94V-0
- Moisture Sensitivity: Level 1 per J-STD-020
- Terminals: Finish — NiPdAu, Solderable per MIL-STD-202, Method 208 
- Weight: 0.0008 grams (Approximate)

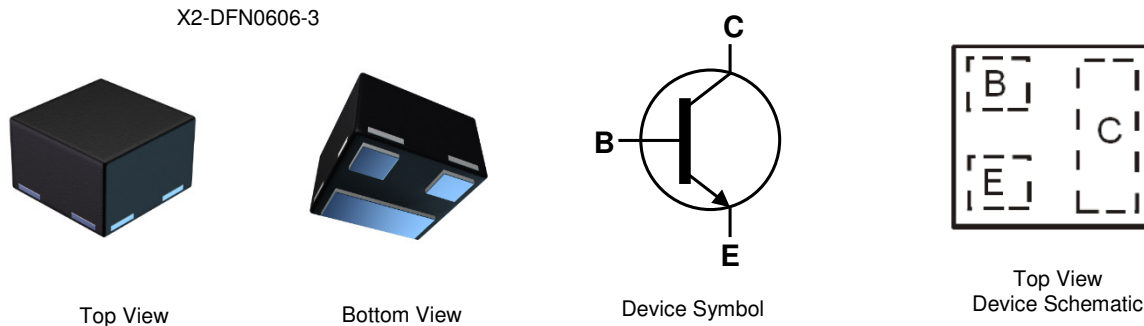

Ordering Information (Note 4)

Product	Marking	Reel Size (inches)	Tape Width (mm)	Quantity per Reel
BC847BFZ-7B	1F	7	8mm	10,000

- Notes:
1. No purposely added lead. Fully EU Directive 2002/95/EC (RoHS) & 2011/65/EU (RoHS 2) compliant.
 2. See http://www.diodes.com/quality/lead_free.html for more information about Diodes Incorporated's definitions of Halogen- and Antimony-free, "Green" and Lead-free.
 3. Halogen- and Antimony-free "Green" products are defined as those which contain <900ppm bromine, <900ppm chlorine (<1500ppm total Br + Cl) and <1000ppm antimony compounds.
 4. For packaging details, go to our website at <http://www.diodes.com/products/packages.html>.

Marking Information

X2-DFN0606-3

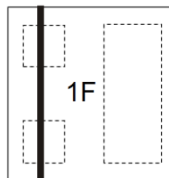

1F = Product Type Marking Code

Top View
Bar Denotes Base and Emitter Side

Absolute Maximum Ratings (@T_A = +25°C, unless otherwise specified.)

Characteristic	Symbol	Value	Unit
Collector-Base Voltage	V _{CBO}	50	V
Collector-Emitter Voltage	V _{CEO}	45	V
Emitter-Base Voltage	V _{EBO}	6.0	V
Continuous Collector Current	I _C	100	mA
Peak Pulse Collector Current	I _{CM}	200	mA

Thermal Characteristics (@T_A = +25°C, unless otherwise specified.)

Characteristic	Symbol	Value	Unit
Power Dissipation	P _D	(Note 5)	270
		(Note 6)	925
Thermal Resistance, Junction to Ambient	R _{θJA}	(Note 5)	465
		(Note 6)	135
Thermal Resistance, Junction to Lead	R _{θJL}	135	°C/W
Operating and Storage and Temperature Range	T _J , T _{STG}	-55 to +150	°C

ESD Ratings (Note 8)

Characteristic	Symbol	Value	Unit	JEDEC Class
Electrostatic Discharge - Human Body Model	ESD HBM	4,000	V	3A
Electrostatic Discharge - Machine Model	ESD MM	200	V	B

- Notes:
5. For the device mounted on minimum recommended pad layout 1oz copper that is on a single-sided 1.6mm FR4 PCB; device is measured under still air conditions whilst operating in steady state condition. The entire exposed collector pad is attached to the heatsink.
 6. Same as Note 5, except the exposed collector pad is mounted on 25mm x 25mm 2oz copper.
 7. Thermal resistance from junction to solder-point (on the exposed collector pad).
 8. Refer to JEDEC specification JESD22-A114 and JESD22-A115.

Thermal Characteristics and Derating Information

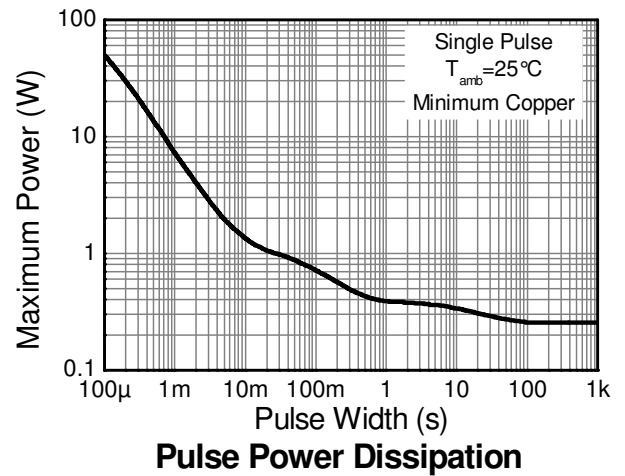
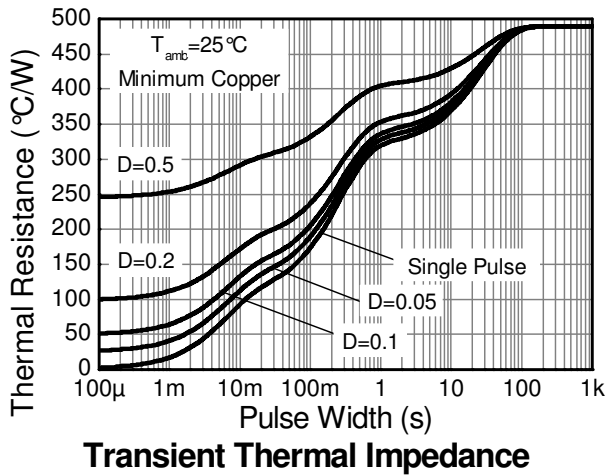
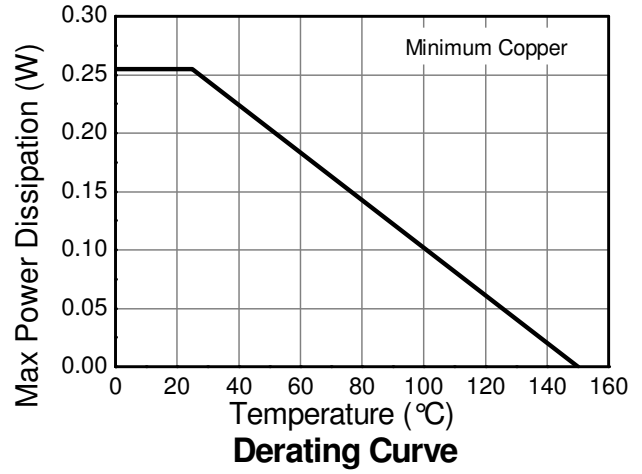
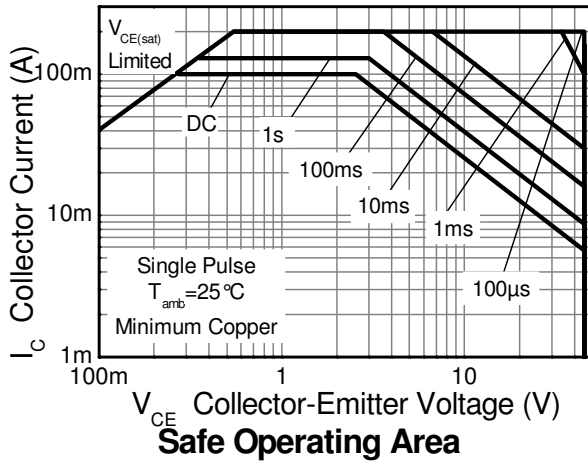

Electrical Characteristics (@T_A = +25°C, unless otherwise specified.)

Characteristic	Symbol	Min	Typical	Max	Unit	Test Condition
OFF CHARACTERISTICS						
Collector-Base Breakdown Voltage	BV _{CB0}	50	150	—	V	I _C = 50μA, I _B = 0
Collector-Emitter Breakdown Voltage	BV _{CES}	50	150	—	—	I _C = 50μA, I _B = 0
Collector-Emitter Breakdown Voltage (Note 9)	BV _{CEO}	45	65	—	V	I _C = 1mA, I _B = 0
Collector-Base Breakdown Voltage	BV _{EBO}	6.0	8.35	—	V	I _E = 50μA, I _C = 0
Collector-Base Cutoff Current	I _{CB0}	—	—	15	nA	V _{CB} = 40V
Collector-Emitter Cutoff Current	I _{CES}	—	—	15	nA	V _{CE} = 40V
ON CHARACTERISTICS (Note 9)						
DC Current Gain	h _{FE}	— 200	220 260	— 470	—	I _C = 10μA, V _{CE} = 5.0V I _C = 2.0mA, V _{CE} = 5.0V
Collector-Emitter Saturation Voltage	V _{CE(sat)}	—	50 122	125 300	mV	I _C = 10mA, I _B = 0.5mA I _C = 100mA, I _B = 5.0mA
Base-Emitter Saturation Voltage	V _{BE(sat)}	—	760 880	1,000 1,100	mV	I _C = 10mA, I _B = 0.5mA I _C = 100mA, I _B = 5.0mA
Base-Emitter Voltage	V _{BE(on)}	580 —	650 725	750 800	mV	I _C = 2.0mA, V _{CE} = 5V I _C = 10mA, V _{CE} = 5V
SMALL SIGNAL CHARACTERISTICS						
Output Capacitance	C _{obo}	—	1.3	—	pF	V _{CB} = 10.0V, f = 1.0MHz, I _E = 0
Current Gain-Bandwidth Product	f _T	100	180	—	MHz	V _{CE} = 5V, I _C = 10mA, f = 100MHz

Note: 9. Measured under pulsed conditions. Pulse width ≤ 300μs. Duty cycle ≤ 2%.

Typical Electrical Characteristics (@ $T_A = +25^\circ\text{C}$, unless otherwise specified.)

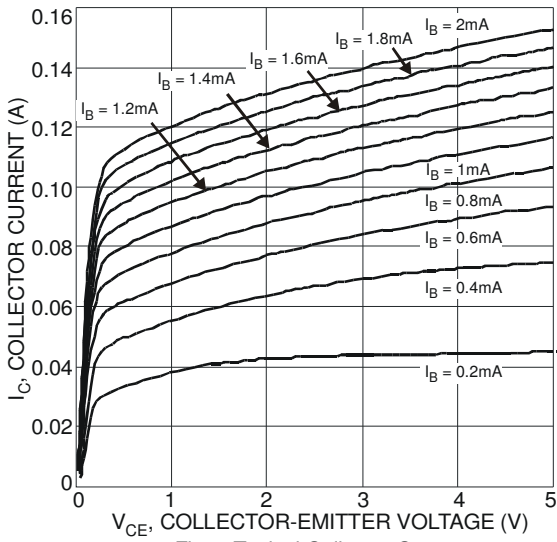

Fig. 4 Typical Collector Current vs. Collector-Emitter Voltage

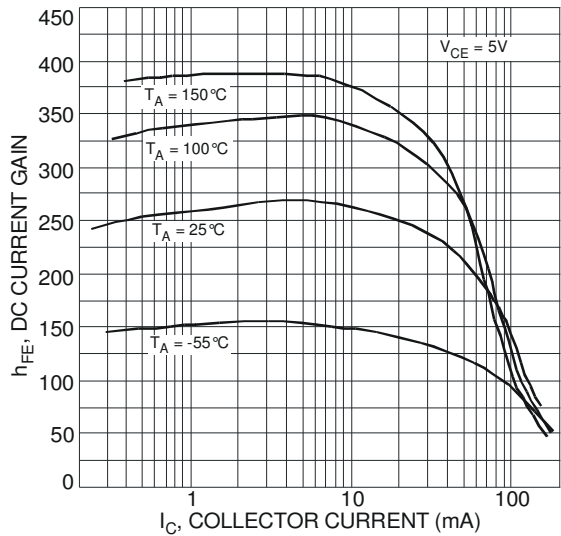

Fig. 5 Typical DC Current Gain vs. Collector Current

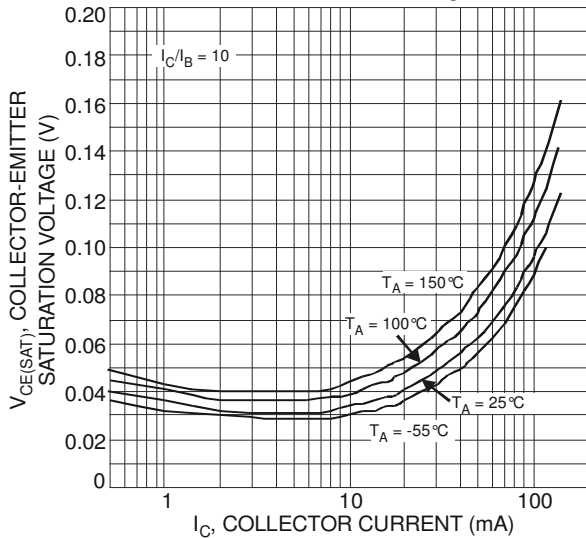

Fig. 6 Typical Collector-Emitter Saturation Voltage vs. Collector Current

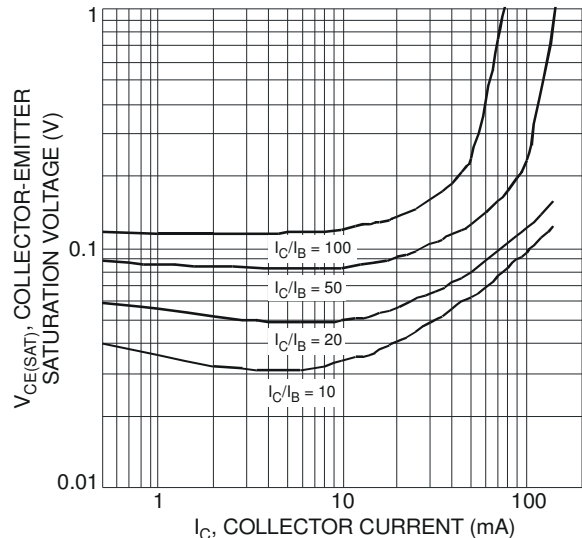

Fig. 7 Typical Collector-Emitter Saturation Voltage vs. Collector Current

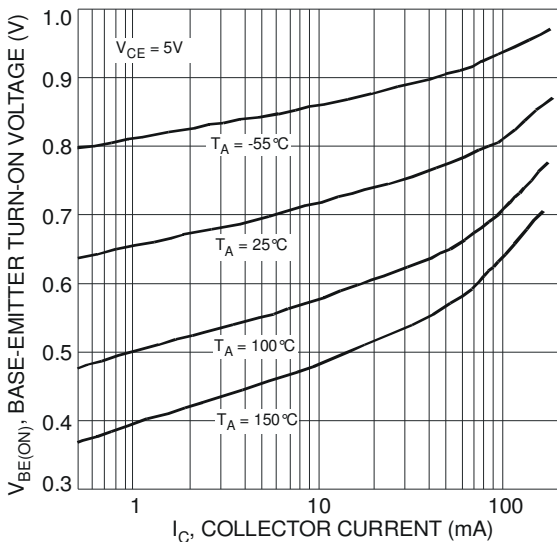

Fig. 8 Typical Base-Emitter Turn-On Voltage vs. Collector Current

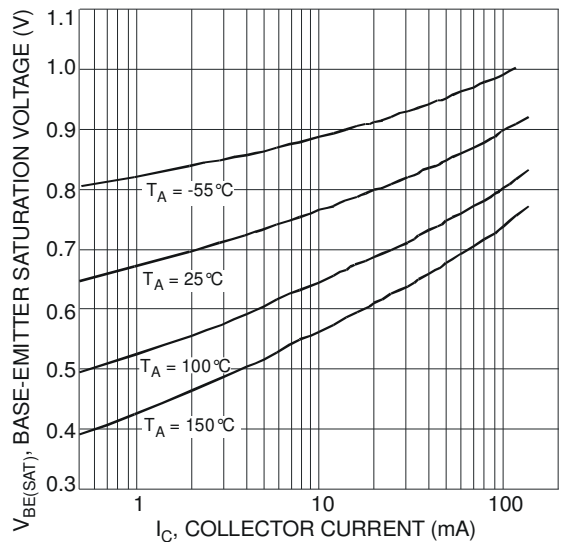
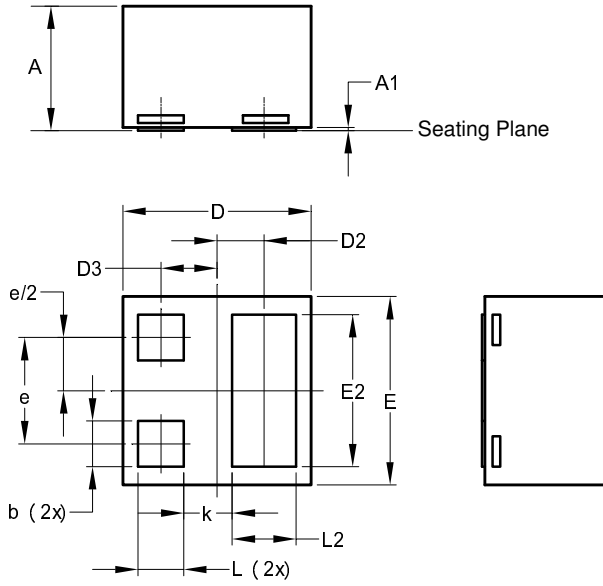

Fig. 9 Typical Base-Emitter Saturation Voltage vs. Collector Current

Package Outline Dimensions

Please see AP02002 at <http://www.diodes.com/datasheets/ap02002.pdf> for the latest version.



X2-DFN0606-3			
Dim	Min	Max	Typ
A	0.36	0.42	0.39
A1	0	0.05	0.02
b	0.10	0.20	0.15
D	0.57	0.67	0.62
D2	0.155 BSC		
D3	0.185 BSC		
E	0.57	0.67	0.62
E2	0.40	0.60	0.50
e	0.35 BSC		
k	0.16 REF		
L	0.09	0.21	0.15
L2	0.11	0.31	0.21
All Dimensions in mm			

Suggested Pad Layout

Please see AP02001 at <http://www.diodes.com/datasheets/ap02001.pdf> for the latest version.

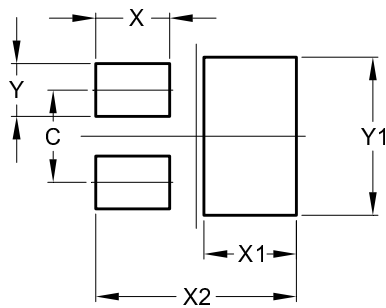

Dimensions	Value (in mm)
C	0.350
X	0.280
X1	0.350
X2	0.760
Y	0.200
Y1	0.600

IMPORTANT NOTICE

DIODES INCORPORATED MAKES NO WARRANTY OF ANY KIND, EXPRESS OR IMPLIED, WITH REGARDS TO THIS DOCUMENT, INCLUDING, BUT NOT LIMITED TO, THE IMPLIED WARRANTIES OF MERCHANTABILITY AND FITNESS FOR A PARTICULAR PURPOSE (AND THEIR EQUIVALENTS UNDER THE LAWS OF ANY JURISDICTION).

Diodes Incorporated and its subsidiaries reserve the right to make modifications, enhancements, improvements, corrections or other changes without further notice to this document and any product described herein. Diodes Incorporated does not assume any liability arising out of the application or use of this document or any product described herein; neither does Diodes Incorporated convey any license under its patent or trademark rights, nor the rights of others. Any Customer or user of this document or products described herein in such applications shall assume all risks of such use and will agree to hold Diodes Incorporated and all the companies whose products are represented on Diodes Incorporated website, harmless against all damages.

Diodes Incorporated does not warrant or accept any liability whatsoever in respect of any products purchased through unauthorized sales channel. Should Customers purchase or use Diodes Incorporated products for any unintended or unauthorized application, Customers shall indemnify and hold Diodes Incorporated and its representatives harmless against all claims, damages, expenses, and attorney fees arising out of, directly or indirectly, any claim of personal injury or death associated with such unintended or unauthorized application.

Products described herein may be covered by one or more United States, international or foreign patents pending. Product names and markings noted herein may also be covered by one or more United States, international or foreign trademarks.

This document is written in English but may be translated into multiple languages for reference. Only the English version of this document is the final and determinative format released by Diodes Incorporated.

LIFE SUPPORT

Diodes Incorporated products are specifically not authorized for use as critical components in life support devices or systems without the express written approval of the Chief Executive Officer of Diodes Incorporated. As used herein:

A. Life support devices or systems are devices or systems which:

1. are intended to implant into the body, or
2. support or sustain life and whose failure to perform when properly used in accordance with instructions for use provided in the labeling can be reasonably expected to result in significant injury to the user.

B. A critical component is any component in a life support device or system whose failure to perform can be reasonably expected to cause the failure of the life support device or to affect its safety or effectiveness.

Customers represent that they have all necessary expertise in the safety and regulatory ramifications of their life support devices or systems, and acknowledge and agree that they are solely responsible for all legal, regulatory and safety-related requirements concerning their products and any use of Diodes Incorporated products in such safety-critical, life support devices or systems, notwithstanding any devices- or systems-related information or support that may be provided by Diodes Incorporated. Further, Customers must fully indemnify Diodes Incorporated and its representatives against any damages arising out of the use of Diodes Incorporated products in such safety-critical, life support devices or systems.

Copyright © 2015, Diodes Incorporated

www.diodes.com



Стандарт Электрон Связь

Мы молодая и активно развивающаяся компания в области поставок электронных компонентов. Мы поставляем электронные компоненты отечественного и импортного производства напрямую от производителей и с крупнейших складов мира.

Благодаря сотрудничеству с мировыми поставщиками мы осуществляем комплексные и плановые поставки широчайшего спектра электронных компонентов.

Собственная эффективная логистика и склад в обеспечивает надежную поставку продукции в точно указанные сроки по всей России.

Мы осуществляем техническую поддержку нашим клиентам и предпродажную проверку качества продукции. На все поставляемые продукты мы предоставляем гарантию .

Осуществляем поставки продукции под контролем ВП МО РФ на предприятия военно-промышленного комплекса России , а также работаем в рамках 275 ФЗ с открытием отдельных счетов в уполномоченном банке. Система менеджмента качества компании соответствует требованиям ГОСТ ISO 9001.

Минимальные сроки поставки, гибкие цены, неограниченный ассортимент и индивидуальный подход к клиентам являются основой для выстраивания долгосрочного и эффективного сотрудничества с предприятиями радиоэлектронной промышленности, предприятиями ВПК и научно-исследовательскими институтами России.

С нами вы становитесь еще успешнее!

Наши контакты:

Телефон: +7 812 627 14 35

Электронная почта: sales@st-electron.ru

Адрес: 198099, Санкт-Петербург,
Промышленная ул, дом № 19, литера Н,
помещение 100-Н Офис 331