

60V COMPLEMENTARY NPN/PNP LOW VCE(sat) TRANSISTOR
Features

- Complementary NPN/PNP
- NPN Transistor
 - $BV_{CEO} > 60V$
 - $I_C = 1A$ high Continuous Collector Current
 - Low Saturation Voltage $V_{CE(sat)} < 220mV @ 1A$
- PNP Transistor
 - $BV_{CEO} > -60V$
 - $I_C = -1A$ high Continuous Collector Current
 - Low Saturation Voltage $V_{CE(sat)} < -340mV @ -1A$
- P_D up to 2.47W for power demanding applications
- $R_{\theta JA}$ efficient, 40% lower than SOT26
- Low profile 0.6mm high package for thin applications
- **Totally Lead-Free & Fully RoHS Compliant (Notes 1 & 2)**
- **Halogen and Antimony Free. "Green" Device (Note 3)**

Mechanical Data

- Case: U-DFN2020-6
- UL Flammability Rating 94V-0
- Case Material: Molded Plastic. "Green" Molding Compound.
- Moisture Sensitivity: Level 1 per J-STD-020
- Terminals: Finish — NiPdAu, Solderable per MIL-STD-202, Method 208 (e4)
- Weight: 0.0065 grams (Approximate)

Application

- Gate Driving
- Load Switches
- Power Management
- Charging Circuits
- Power Switches (e.g. Motors, Fans)

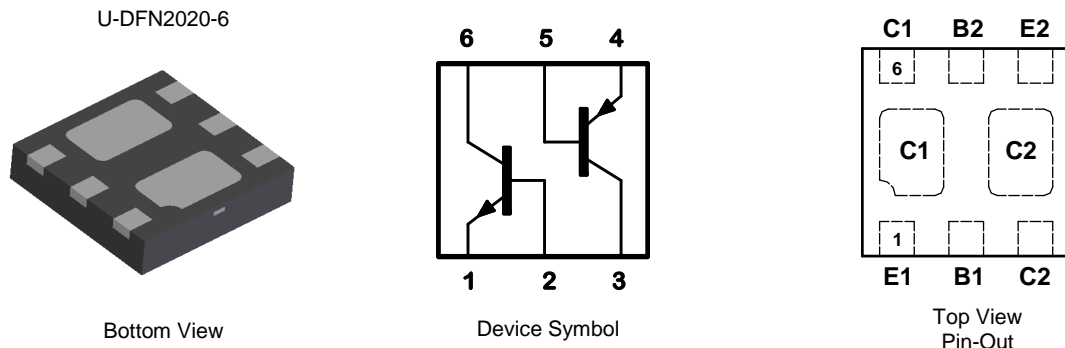
Ordering Information (Note 4)

Product	Marking	Reel size (inches)	Tape width (mm)	Quantity per reel
DSS45160FDB-7	2C	7	8	3,000

- Notes:
1. No purposely added lead. Fully EU Directive 2002/95/EC (RoHS) & 2011/65/EU (RoHS 2) compliant.
 2. See http://www.diodes.com/quality/lead_free.html for more information about Diodes Incorporated's definitions of Halogen- and Antimony-free, "Green" and Lead-free.
 3. Halogen- and Antimony-free "Green" products are defined as those which contain <900ppm bromine, <900ppm chlorine (<1500ppm total Br + Cl) and <1000ppm antimony compounds.
 4. For packaging details, go to our website at <http://www.diodes.com/products/packages.html>.

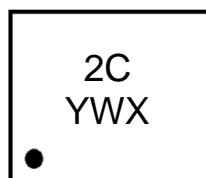
Marking Information

2C = Product type Marking Code
 Y = Year: 0~9
 W = Week: A~Z : 1~26 week;
 a~z; 27~52 week; z represents
 52 and 53 week
 X = A~Z: Internal code

Absolute Maximum Ratings – Q1 and Q2 (@T_A = +25°C, unless otherwise specified.)

Characteristic	Symbol	NPN	PNP	Unit
Collector-Base Voltage	V _{CB0}	60	-60	V
Collector-Emitter Voltage	V _{CEO}	60	-60	V
Emitter-Base Voltage	V _{EBO}	7	-7	V
Continuous Collector Current	I _C	1	-1	A
Peak Pulse Collector Current	I _{CM}	1.5	-1.5	A
Base Current	I _B	300	-300	mA
Peak Base Current	I _{BM}	1	-1	A

Thermal Characteristics (@T_A = +25°C, unless otherwise specified.)

Characteristic	Symbol	Value	Unit
Power Dissipation	P _D	(Notes 5 & 7)	405
		(Notes 5 & 8)	510
		(Notes 6 & 7)	1650
		(Notes 6 & 8)	2470
Thermal Resistance, Junction to Ambient	R _{θJA}	(Notes 5 & 7)	308
		(Notes 5 & 8)	245
		(Notes 6 & 7)	76
		(Notes 6 & 8)	51
Thermal Resistance, Junction to Lead	(Note 9)	R _{θJL}	18
Operating and Storage Temperature Range	T _J , T _{STG}	-55 to +150	°C

ESD Ratings (Note 10)

Characteristic	Symbol	Value	Unit	JEDEC Class
Electrostatic Discharge – Human Body Model	ESD HBM	4,000	V	3A
Electrostatic Discharge – Machine Model	ESD MM	400	V	C

- Notes:
- For a device mounted with the exposed collector pads on minimum recommended pad layout that is on a single-sided 1.6mm FR4 PCB; device is measured under still air conditions whilst operating in a steady-state.
 - Same as note (5), except the device is mounted with the collector pad on 28mm x 28mm (8cm²) 2oz copper.
 - For a dual device with one active die.
 - For dual device with 2 active die running at equal power.
 - Thermal resistance from junction to solder-point (on the exposed collector pads).
 - Refer to JEDEC specification JESD22-A114 and JESD22-A115.

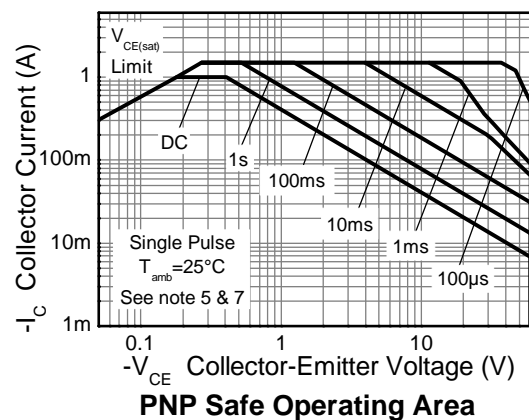
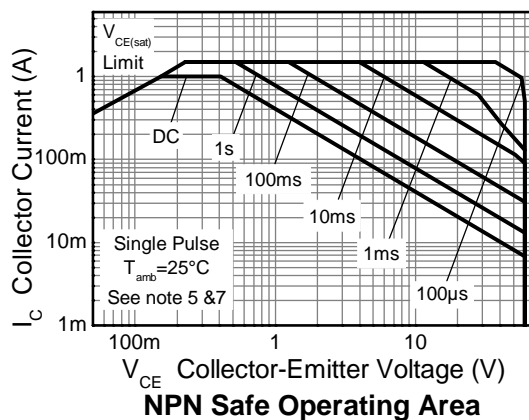
Thermal Characteristics and Derating Information

Thermal Characteristics and Derating Information

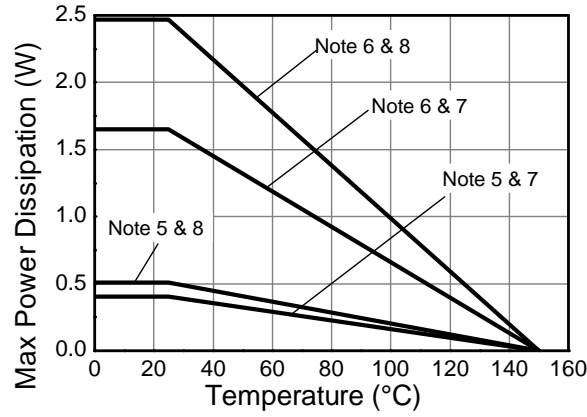

Derating Curve

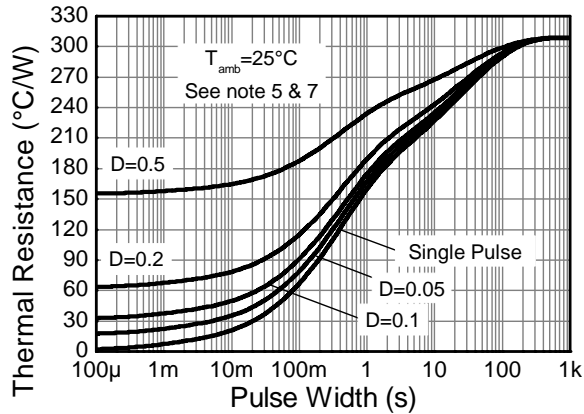

Transient Thermal Impedance

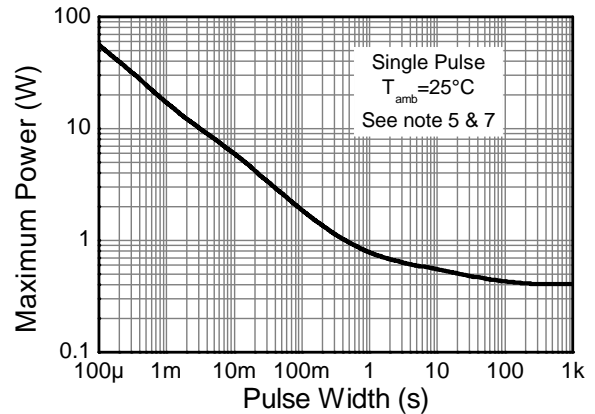

Pulse Power Dissipation

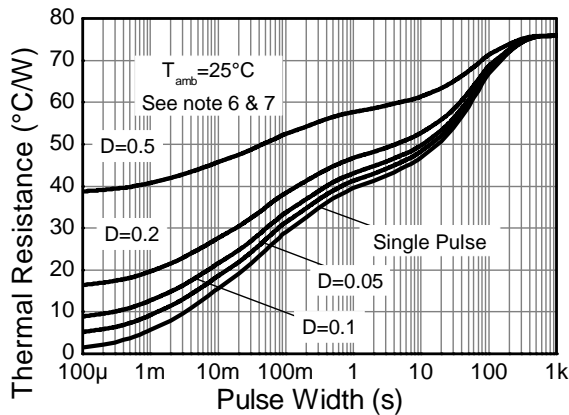

Transient Thermal Impedance

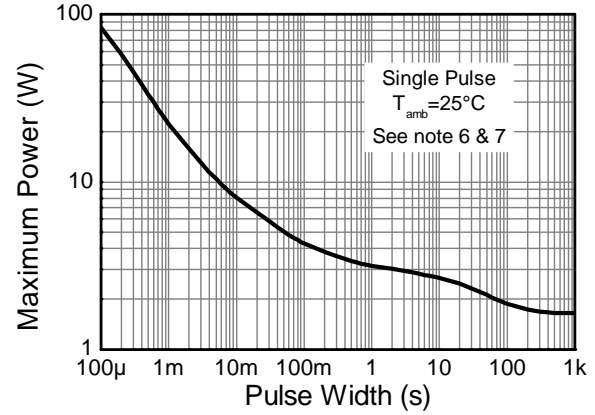

Pulse Power Dissipation

Electrical Characteristics – Q1 NPN (@ $T_A = +25^\circ\text{C}$, unless otherwise specified.)

Characteristic	Symbol	Min	Typ	Max	Unit	Test Conditions
Collector-Base Breakdown Voltage	BV_{CBO}	60	—	—	V	$I_C = 100\mu\text{A}$
Collector-Emitter Breakdown Voltage (Note 11)	BV_{CEO}	60	—	—	V	$I_C = 10\text{mA}$
Emitter-Base Breakdown Voltage	BV_{EBO}	7	—	—	V	$I_E = 100\mu\text{A}$
Collector-Base Cutoff Current	I_{CBO}	—	—	100	nA	$V_{CB} = 48\text{V}, I_E = 0$
		—	—	50	μA	$V_{CB} = 48\text{V}, I_E = 0, T_A = +150^\circ\text{C}$
Emitter-Base Cutoff Current	I_{EBO}	—	—	100	nA	$V_{EB} = 5.6\text{V}, I_C = 0$
DC Current Gain (Note 11)	h_{FE}	290	430	—	—	$V_{CE} = 2\text{V}, I_C = 100\text{mA}$
		150	220	—		$V_{CE} = 2\text{V}, I_C = 500\text{mA}$
		70	110	—		$V_{CE} = 2\text{V}, I_C = 1\text{A}$
Collector-Emitter Saturation Voltage (Note 11)	$V_{CE(sat)}$	—	90	120	mV	$I_C = 500\text{mA}, I_B = 50\text{mA}$
		—	170	220		$I_C = 1\text{A}, I_B = 100\text{mA}$
		—	185	240		$I_C = 1\text{A}, I_B = 50\text{mA}$
Equivalent On-Resistance (Note 11)	$R_{CE(sat)}$	—	180	240	m Ω	$I_C = 500\text{mA}, I_B = 50\text{mA}$
Base-Emitter Saturation Voltage (Note 11)	$V_{BE(sat)}$	—	—	1	V	$I_C = 0.5\text{A}, I_B = 50\text{mA}$
		—	—	1.1		$I_C = 1\text{A}, I_B = 50\text{mA}$
		—	—	1.1		$I_C = 1\text{A}, I_B = 100\text{mA}$
Base-Emitter Turn-on Voltage (Note 11)	$V_{BE(on)}$	—	—	0.9	V	$V_{CE} = 2\text{V}, I_C = 0.5\text{A}$
Transition Frequency	f_T	90	175	—	MHz	$V_{CE} = 10\text{V}, I_C = 50\text{mA}, f = 100\text{MHz}$
Output (Collector) Capacitance	$C_{ob(c)}$	—	4	6	pF	$V_{CB} = -10\text{V}, f = 1\text{MHz}$
Turn-On Time	t_{on}	—	105	—	ns	$V_{CC} = -10\text{V}, I_C = -0.5\text{A}, I_{B1} = -I_{B2} = 25\text{mA}$
Delay Time	t_d	—	15	—	ns	
Rise Time	t_r	—	90	—	ns	
Turn-Off Time	t_{off}	—	540	—	ns	
Storage Time	t_s	—	410	—	ns	
Fall Time	t_f	—	130	—	ns	

Note: 11. Measured under pulsed conditions. Pulse width $\leq 300\mu\text{s}$. Duty cycle $\leq 2\%$.

Electrical Characteristics – Q2 PNP (@ $T_A = +25^\circ\text{C}$, unless otherwise specified.)

Characteristic	Symbol	Min	Typ	Max	Unit	Test Conditions
Collector-Base Breakdown Voltage	BV_{CBO}	-60	—	—	V	$I_C = -100\mu\text{A}$
Collector-Emitter Breakdown Voltage (Note 11)	BV_{CEO}	-60	—	—	V	$I_C = -10\text{mA}$
Emitter-Base Breakdown Voltage	BV_{EBO}	-7	—	—	V	$I_E = -100\mu\text{A}$
Collector-Base Cutoff Current	I_{CBO}	—	—	-100	nA	$V_{CB} = -48\text{V}, I_E = 0$
		—	—	-50	μA	$V_{CB} = -48\text{V}, I_E = 0, T_A = +150^\circ\text{C}$
Emitter-Base Cutoff Current	I_{EBO}	—	—	-100	nA	$V_{EB} = -5.6\text{V}, I_C = 0$
DC Current Gain (Note 11)	h_{FE}	170	—	—	—	$V_{CE} = -2\text{V}, I_C = -100\text{mA}$
		120	—	—		$V_{CE} = -2\text{V}, I_C = -500\text{mA}$
		70	—	—		$V_{CE} = -2\text{V}, I_C = -1\text{A}$
Collector-Emitter Saturation Voltage (Note 11)	$V_{CE(sat)}$	—	—	-180	mV	$I_C = -500\text{mA}, I_B = -50\text{mA}$
		—	—	-340		$I_C = -1\text{A}, I_B = -100\text{mA}$
		—	—	-550		$I_C = -1\text{A}, I_B = -50\text{mA}$
Equivalent On-Resistance (Note 11)	$R_{CE(sat)}$	—	—	360	m Ω	$I_C = -500\text{mA}, I_B = -50\text{mA}$
Base-Emitter Saturation Voltage (Note 11)	$V_{BE(sat)}$	—	—	-1	V	$I_C = -0.5\text{A}, I_B = -50\text{mA}$
		—	—	-1.0		$I_C = -1\text{A}, I_B = -50\text{mA}$
		—	—	-1.1		$I_C = -1\text{A}, I_B = -100\text{mA}$
Base-Emitter Turn-on Voltage (Note 11)	$V_{BE(on)}$	—	—	-0.9	V	$V_{CE} = -2\text{V}, I_C = -0.5\text{A}$
Transition Frequency	f_T	65	—	—	MHz	$V_{CE} = -10\text{V}, I_C = -50\text{mA}, f = 100\text{MHz}$
Output Capacitance	C_{ob}	—	—	15	pF	$V_{CB} = -10\text{V}, f = 1\text{MHz}$
Turn-On Time	t_{on}	—	75	—	ns	$V_{CC} = -10\text{V}, I_C = -0.5\text{A}, I_{B1} = -I_{B2} = 25\text{mA}$
Delay Time	t_d	—	35	—	ns	
Rise Time	t_r	—	40	—	ns	
Turn-Off Time	t_{off}	—	265	—	ns	
Storage Time	t_s	—	230	—	ns	
Fall Time	t_f	—	35	—	ns	

Note: 11. Measured under pulsed conditions. Pulse width $\leq 300\mu\text{s}$. Duty cycle $\leq 2\%$.

Typical Electrical Characteristics - Q1 NPN (@ $T_A = +25^\circ\text{C}$, unless otherwise specified.)

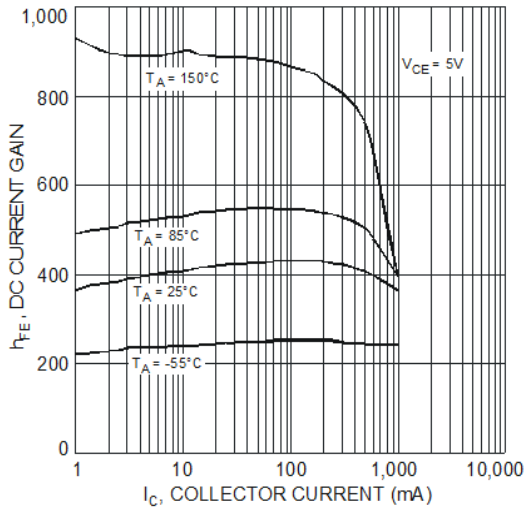

Fig. 1 Typical DC Current Gain vs. Collector Current

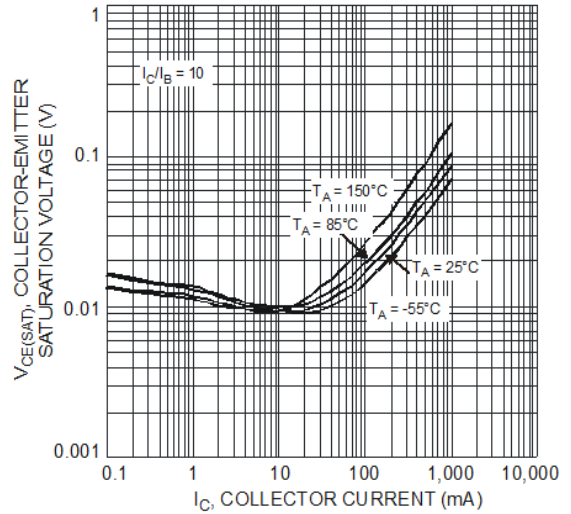

Fig. 2 Typical Collector-Emitter Saturation Voltage vs. Collector Current

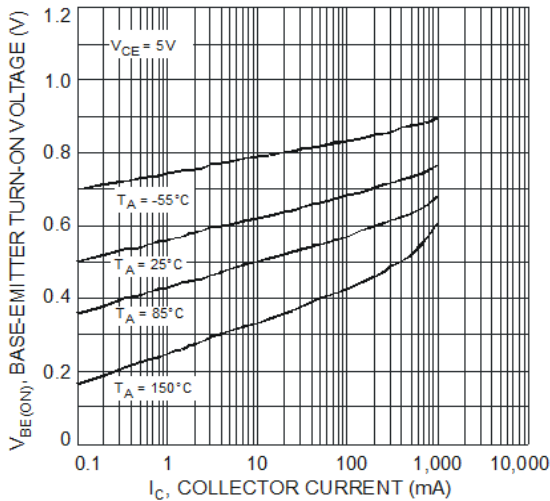

Fig. 3 Typical Base-Emitter Turn-On Voltage vs. Collector Current

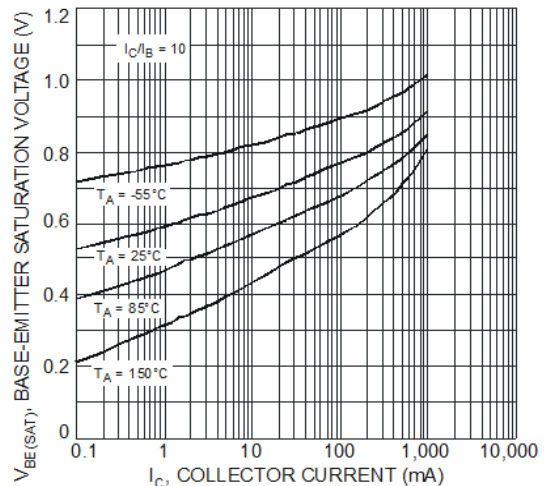

Fig. 4 Typical Base-Emitter Saturation Voltage vs. Collector Current

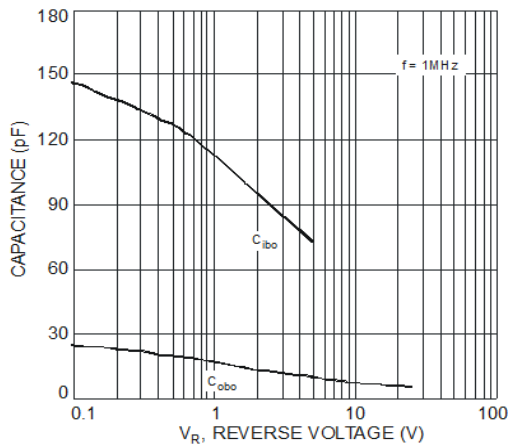
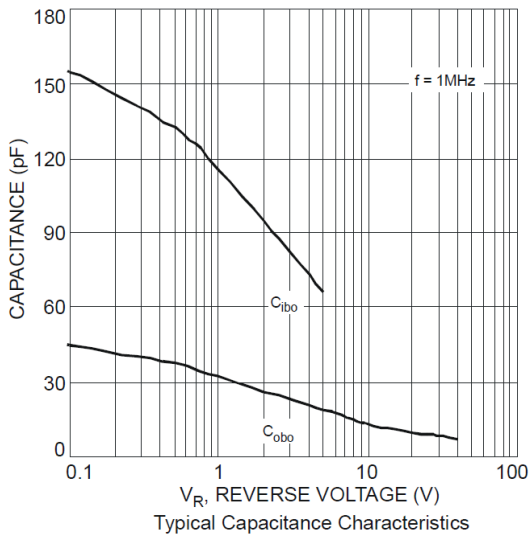
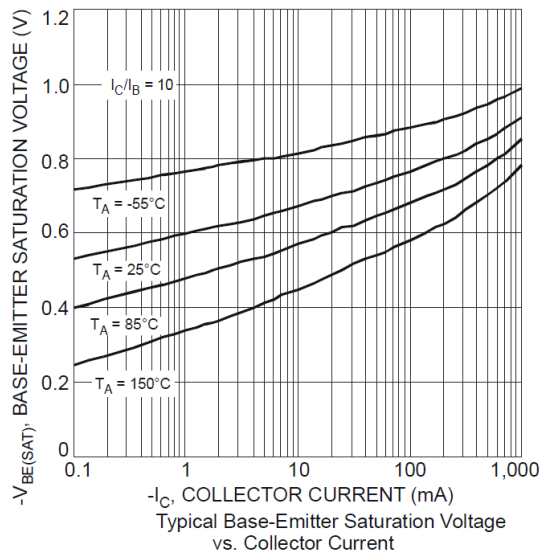
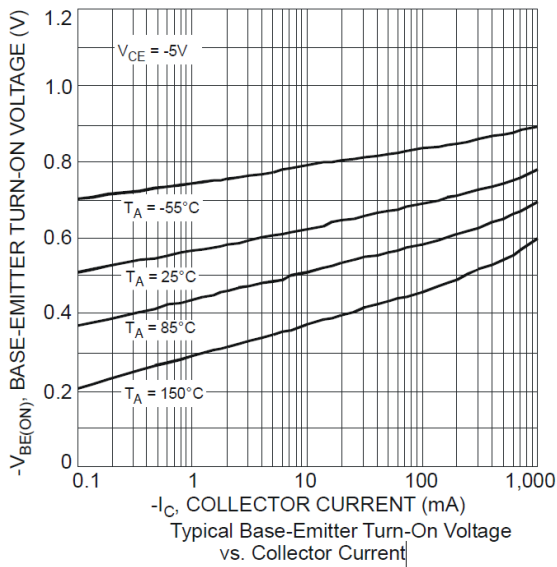
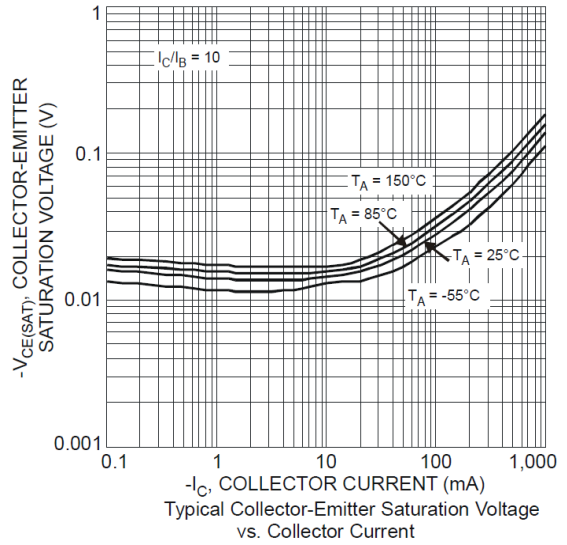
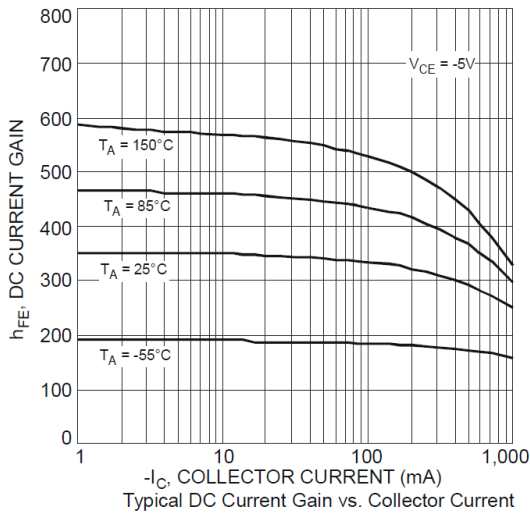

Fig. 5 Typical Capacitance Characteristics

Typical Electrical Characteristics - Q2 PNP (@T_A = +25°C, unless otherwise specified.)



Package Outline Dimensions

Please see AP02001 at http://www.diodes.com/_files/datasheets/ap02001.pdf for the latest version.

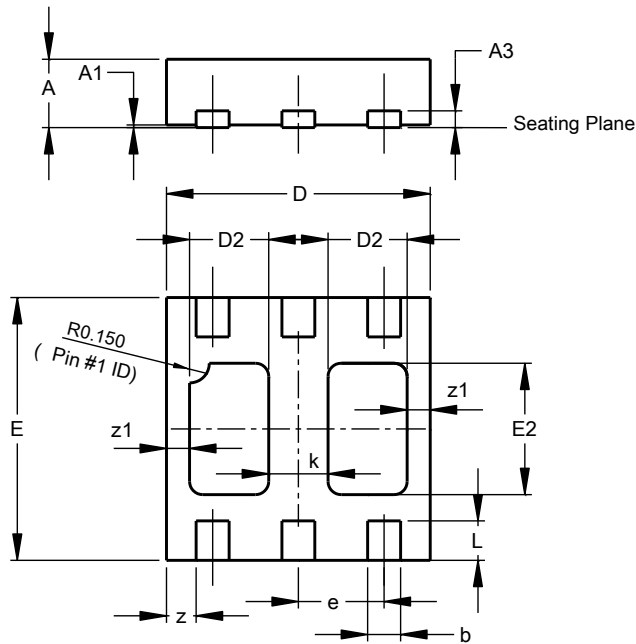

U-DFN2020-6			
Type B			
Dim	Min	Max	Typ
A	0.545	0.605	0.575
A1	0.00	0.05	0.02
A3	-	-	0.13
b	0.20	0.30	0.25
D	1.95	2.075	2.00
D2	0.50	0.70	0.60
e	-	-	0.65
E	1.95	2.075	2.00
E2	0.90	1.10	1.00
k	-	-	0.45
L	0.25	0.35	0.30
z	-	-	0.225
z1	-	-	0.175
All Dimensions in mm			

Suggested Pad Layout

Please see AP02001 at http://www.diodes.com/_files/datasheets/ap02001.pdf for the latest version.

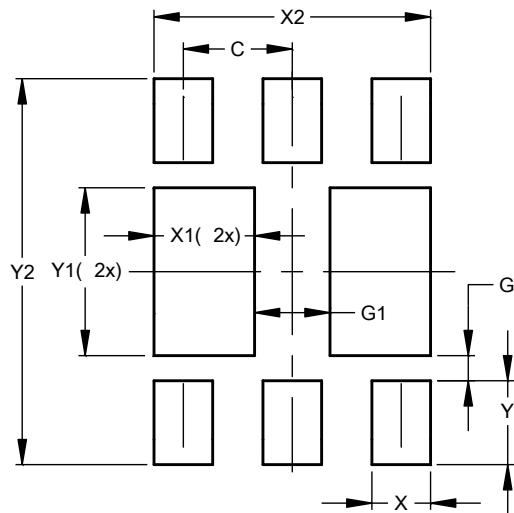

Dimensions	Value (in mm)
C	0.650
G	0.150
G1	0.450
X	0.350
X1	0.600
X2	1.650
Y	0.500
Y1	1.000
Y2	2.300

IMPORTANT NOTICE

DIODES INCORPORATED MAKES NO WARRANTY OF ANY KIND, EXPRESS OR IMPLIED, WITH REGARDS TO THIS DOCUMENT, INCLUDING, BUT NOT LIMITED TO, THE IMPLIED WARRANTIES OF MERCHANTABILITY AND FITNESS FOR A PARTICULAR PURPOSE (AND THEIR EQUIVALENTS UNDER THE LAWS OF ANY JURISDICTION).

Diodes Incorporated and its subsidiaries reserve the right to make modifications, enhancements, improvements, corrections or other changes without further notice to this document and any product described herein. Diodes Incorporated does not assume any liability arising out of the application or use of this document or any product described herein; neither does Diodes Incorporated convey any license under its patent or trademark rights, nor the rights of others. Any Customer or user of this document or products described herein in such applications shall assume all risks of such use and will agree to hold Diodes Incorporated and all the companies whose products are represented on Diodes Incorporated website, harmless against all damages.

Diodes Incorporated does not warrant or accept any liability whatsoever in respect of any products purchased through unauthorized sales channel. Should Customers purchase or use Diodes Incorporated products for any unintended or unauthorized application, Customers shall indemnify and hold Diodes Incorporated and its representatives harmless against all claims, damages, expenses, and attorney fees arising out of, directly or indirectly, any claim of personal injury or death associated with such unintended or unauthorized application.

Products described herein may be covered by one or more United States, international or foreign patents pending. Product names and markings noted herein may also be covered by one or more United States, international or foreign trademarks.

This document is written in English but may be translated into multiple languages for reference. Only the English version of this document is the final and determinative format released by Diodes Incorporated.

LIFE SUPPORT

Diodes Incorporated products are specifically not authorized for use as critical components in life support devices or systems without the express written approval of the Chief Executive Officer of Diodes Incorporated. As used herein:

- A. Life support devices or systems are devices or systems which:
 - 1. are intended to implant into the body, or
 - 2. support or sustain life and whose failure to perform when properly used in accordance with instructions for use provided in the labeling can be reasonably expected to result in significant injury to the user.
- B. A critical component is any component in a life support device or system whose failure to perform can be reasonably expected to cause the failure of the life support device or to affect its safety or effectiveness.

Customers represent that they have all necessary expertise in the safety and regulatory ramifications of their life support devices or systems, and acknowledge and agree that they are solely responsible for all legal, regulatory and safety-related requirements concerning their products and any use of Diodes Incorporated products in such safety-critical, life support devices or systems, notwithstanding any devices- or systems-related information or support that may be provided by Diodes Incorporated. Further, Customers must fully indemnify Diodes Incorporated and its representatives against any damages arising out of the use of Diodes Incorporated products in such safety-critical, life support devices or systems.

Copyright © 2016, Diodes Incorporated

www.diodes.com



Стандарт Электрон Связь

Мы молодая и активно развивающаяся компания в области поставок электронных компонентов. Мы поставляем электронные компоненты отечественного и импортного производства напрямую от производителей и с крупнейших складов мира.

Благодаря сотрудничеству с мировыми поставщиками мы осуществляем комплексные и плановые поставки широчайшего спектра электронных компонентов.

Собственная эффективная логистика и склад в обеспечивает надежную поставку продукции в точно указанные сроки по всей России.

Мы осуществляем техническую поддержку нашим клиентам и предпродажную проверку качества продукции. На все поставляемые продукты мы предоставляем гарантию .

Осуществляем поставки продукции под контролем ВП МО РФ на предприятия военно-промышленного комплекса России , а также работаем в рамках 275 ФЗ с открытием отдельных счетов в уполномоченном банке. Система менеджмента качества компании соответствует требованиям ГОСТ ISO 9001.

Минимальные сроки поставки, гибкие цены, неограниченный ассортимент и индивидуальный подход к клиентам являются основой для выстраивания долгосрочного и эффективного сотрудничества с предприятиями радиоэлектронной промышленности, предприятиями ВПК и научно-исследовательскими институтами России.

С нами вы становитесь еще успешнее!

Наши контакты:

Телефон: +7 812 627 14 35

Электронная почта: sales@st-electron.ru

Адрес: 198099, Санкт-Петербург,
Промышленная ул, дом № 19, литера Н,
помещение 100-Н Офис 331