

FEATURES

- High data rate: dc to 100 Mbps (NRZ)**
- Compatible with 3.3 V and 5.0 V operation/level translation**
- 125°C maximum operating temperature**
- Low power operation**
 - 5 V operation**
 - 1.0 mA maximum @ 1 Mbps**
 - 4.5 mA maximum @ 25 Mbps**
 - 16.8 mA maximum @ 100 Mbps**
 - 3.3 V operation**
 - 0.4 mA maximum @ 1 Mbps**
 - 3.5 mA maximum @ 25 Mbps**
 - 7.1 mA maximum @ 50 Mbps**
- 8-lead SOIC_N package (RoHS compliant version available)**
- High common-mode transient immunity: >25 kV/μs**
- Safety and regulatory approvals**
 - UL recognized**
 - 2500 V rms for 1 minute per UL 1577**
 - CSA Component Acceptance Notice #5A**
 - VDE Certificate of Conformity**
 - DIN V VDE V 0884-10 (VDE V 0884-10):2006-12**
 - V_{IORM} = 560 V peak**

APPLICATIONS

- Digital field bus isolation
- Opto-isolator replacement
- Computer peripheral interface
- Microprocessor system interface
- General instrumentation and data acquisition applications

GENERAL DESCRIPTION

The ADuM1100¹ is a digital isolator based on Analog Devices Inc., iCoupler® technology. Combining high speed CMOS and monolithic air core transformer technology, this isolation component provides outstanding performance characteristics superior to alternatives, such as optocoupler devices.

Configured as a pin-compatible replacement for existing high speed optocouplers, the ADuM1100 supports data rates as high as 25 Mbps and 100 Mbps.

The ADuM1100 operates with a voltage supply ranging from 3.0 V to 5.5 V, boasts a propagation delay of <18 ns and edge asymmetry of <2 ns, and is compatible with temperatures up to 125°C. It operates at very low power, less than 0.9 mA of quiescent current (sum of both sides), and a dynamic current of less than 160 μA per Mbps of data rate. Unlike other optocoupler alternatives, the ADuM1100 provides dc correctness with a patented refresh feature that continuously updates the output signal.

The ADuM1100 is offered in three grades. The ADuM1100AR and ADuM1100BR can operate up to a maximum temperature of 105°C and support data rates up to 25 Mbps and 100 Mbps, respectively. The ADuM1100UR can operate up to a maximum temperature of 125°C and supports data rates up to 100 Mbps.

¹ Protected by U.S. Patents 5,952,849; 6,525,566; 6,922,080; 6,903,578; 6,873,065; 7,075,329.

FUNCTIONAL BLOCK DIAGRAM

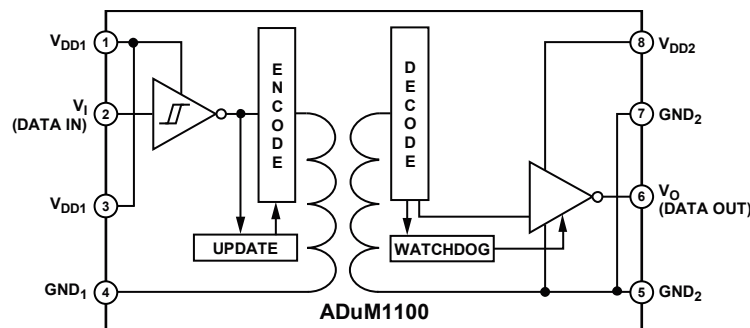

NOTES
1. FOR PRINCIPLES OF OPERATION, SEE METHOD OF OPERATION, DC CORRECTNESS, AND MAGNETIC FIELD IMMUNITY SECTION.

Figure 1.

02462-001

Rev. I

Information furnished by Analog Devices is believed to be accurate and reliable. However, no responsibility is assumed by Analog Devices for its use, nor for any infringements of patents or other rights of third parties that may result from its use. Specifications subject to change without notice. No license is granted by implication or otherwise under any patent or patent rights of Analog Devices. Trademarks and registered trademarks are the property of their respective owners.

TABLE OF CONTENTS

Features	1	Recommended Operating Conditions	11
Applications	1	Absolute Maximum Ratings	12
General Description	1	ESD Caution.....	12
Functional Block Diagram	1	Pin Configuration and Function Descriptions.....	13
Revision History	3	Typical Performance Characteristics	14
Specifications.....	4	Application Information.....	16
Electrical Specifications—5 V Operation	4	PC Board Layout	16
Electrical Specifications—3.3 V Operation	6	Propagation Delay-Related Parameters.....	16
Electrical Specifications—Mixed 5 V/3 V or 3 V/5 V Operation.....	8	Method of Operation, DC Correctness, and Magnetic Field Immunity	17
Package Characteristics	10	Power Consumption	18
Regulatory Information.....	10	Outline Dimensions	19
Insulation and Safety-Related Specifications.....	10	Ordering Guide	19
DIN V VDE V 0884-10 (VDE V 0884-10):2006-12 Insulation Characteristics.....	11		

REVISION HISTORY**3/12—Rev. H to Rev. I**

Created Hyperlink for Safety and Regulatory Approvals	
Entry in Features Section	1
Change to PC Board Layout Section	16

3/11—Rev. G to Rev. H

Changes to Data Sheet Title	1
Changes to Ordering Guide	18

6/07—Rev. F to Rev. G

Updated VDE Certification Throughout	1
Changes to Features and Endnote 1	1
Changes to Table 5 and Table 6	9
Updated Outline Dimensions	18
Changes to Ordering Guide	18

3/06—Rev. E to Rev. F

Updated Format	Universal
Added Note 1	1
Changes to Table 1	4
Changes to Table 2	6
Changes to Table 3	8
Added Table 11	13
Inserted Power Consumption Section	18

10/03—Rev. D to Rev. E

Changes to Product Name, Features, and General Description .	1
Changes to Regulatory Information	6
Changes to DIN EN 60747-5-2 (VDE 0884 Part 2) Insulation Characteristics	6
Changes to Absolute Maximum Ratings	7
Changes to Recommended Operating Conditions	7
Changes to Ordering Guide	8

6/03—Rev. C to Rev. D

Changed DIN EN 60747-5-2 (VDE 0884 Part 2) Insulation Characteristics	6
Updated Ordering Guide	8
Updated Outline Dimensions	13

4/03—Rev. B to Rev. C

Changes to Features and Patent Note	1
Changes to Regulatory Information	6
Changes to Insulation Characteristics Section	6
Changes to Absolute Maximum Ratings	7
Changes to Package Branding	8
Changes to Method of Operation, DC Correctness, and Magnetic Field Immunity Section	11
Replaced Figure 9	12

1/03—Rev. A to Rev. B

Added ADuM1100UR Grade	Universal
Changed ADuM1100AR/ADuM1100BR to ADuM1100	Universal
Changes to Features and General Description	1
Changes to Specifications	2
Added Electrical Specifications, Mixed 5 V/3 V or 3 V/5 V Operation Table	4
Updated Regulatory Information	6
Changes to VDE 0884 Insulation Characteristics	6
Changes to Absolute Maximum Ratings	7
Changes to Package Branding	8
Updated TPC 3 to TPC 8	9
Deleted iCoupler in Field Bus Networks Section	11
Changes to Figure 8	12
Added Figure 9 and Related Text	12

11/02—Rev. 0 to Rev. A

Edits to Features	1
Edits to Regulatory Information	4
Edits to VDE 0884 Insulation Characteristics	5
Added Revision History	12
Updated Outline Dimensions	12

SPECIFICATIONS

ELECTRICAL SPECIFICATIONS—5 V OPERATION

All voltages are relative to their respective ground. $4.5\text{ V} \leq V_{DD1} \leq 5.5\text{ V}$, $4.5\text{ V} \leq V_{DD2} \leq 5.5\text{ V}$. All minimum/maximum specifications apply over the entire recommended operation range, unless otherwise noted. All typical specifications are at $T_A = 25^\circ\text{C}$, $V_{DD1} = V_{DD2} = 5\text{ V}$.

Table 1.

Parameter	Symbol	Min	Typ	Max	Unit	Test Conditions
DC SPECIFICATIONS						
Input Supply Current	$I_{DD1(Q)}$		0.3	0.8	mA	$V_I = 0\text{ V}$ or V_{DD1}
Output Supply Current	$I_{DD2(Q)}$		0.01	0.06	mA	$V_I = 0\text{ V}$ or V_{DD1}
Input Supply Current (25 Mbps) (See Figure 5)	$I_{DD1(25)}$		2.2	3.5	mA	12.5 MHz logic signal frequency
Output Supply Current ¹ (25 Mbps) (See Figure 6)	$I_{DD2(25)}$		0.5	1.0	mA	12.5 MHz logic signal frequency
Input Supply Current (100 Mbps) (See Figure 5)	$I_{DD1(100)}$		9.0	14	mA	50 MHz logic signal frequency, ADuM1100BR/ADuM1100UR only
Output Supply Current ¹ (100 Mbps) (See Figure 6)	$I_{DD2(100)}$		2.0	2.8	mA	50 MHz logic signal frequency, ADuM1100BR/ADuM1100UR only
Input Current	I_I	-10	+0.01	+10	μA	$0\text{ V} \leq V_{IN} \leq V_{DD1}$
Logic High Output Voltage	V_{OH}	$V_{DD2} - 0.1$	5.0		V	$I_O = -20\text{ }\mu\text{A}$, $V_I = V_{IH}$
		$V_{DD2} - 0.8$	4.6		V	$I_O = -4\text{ mA}$, $V_I = V_{IH}$
Logic Low Output Voltage	V_{OL}		0.0	0.1	V	$I_O = 20\text{ }\mu\text{A}$, $V_I = V_{IL}$
			0.03	0.1	V	$I_O = 400\text{ }\mu\text{A}$, $V_I = V_{IL}$
			0.3	0.8	V	$I_O = 4\text{ mA}$, $V_I = V_{IL}$
SWITCHING SPECIFICATIONS						
For ADuM1100AR						
Minimum Pulse Width ²	PW			40	ns	$C_L = 15\text{ pF}$, CMOS signal levels
Maximum Data Rate ³		25			Mbps	$C_L = 15\text{ pF}$, CMOS signal levels
For ADuM1100BR/ADuM1100UR						
Minimum Pulse Width ²	PW		6.7	10	ns	$C_L = 15\text{ pF}$, CMOS signal levels
Maximum Data Rate ³		100	150		Mbps	$C_L = 15\text{ pF}$, CMOS signal levels
For All Grades						
Propagation Delay Time to Logic Low Output ^{4, 5} (See Figure 7)	t_{PHL}		10.5	18	ns	$C_L = 15\text{ pF}$, CMOS signal levels
Propagation Delay Time to Logic High Output ^{4, 5} (See Figure 7)	t_{PLH}		10.5	18	ns	$C_L = 15\text{ pF}$, CMOS signal levels
Pulse Width Distortion [$t_{PLH} - t_{PHL}$] ⁵	PWD		0.5	2	ns	$C_L = 15\text{ pF}$, CMOS signal levels
Change vs. Temperature ⁶			3		ps/ $^\circ\text{C}$	$C_L = 15\text{ pF}$, CMOS signal levels
Propagation Delay Skew (Equal Temperature) ^{5, 7}	t_{PSK1}			8	ns	$C_L = 15\text{ pF}$, CMOS signal levels
Propagation Delay Skew (Equal Temperature, Supplies) ^{5, 7}	t_{PSK2}			6	ns	$C_L = 15\text{ pF}$, CMOS signal levels
Output Rise/Fall Time	t_R, t_F		3		ns	$C_L = 15\text{ pF}$, CMOS signal levels
Common-Mode Transient Immunity at Logic Low/High Output ⁸	$ CM_L $, $ CM_H $	25	35		kV/ μs	$V_I = 0\text{ V}$ or V_{DD1} , $V_{CM} = 1000\text{ V}$, transient magnitude = 800 V
Refresh Rate	f_r		1.2		Mbps	
Input Dynamic Supply Current ⁹	$I_{DD1(D)}$		0.09		mA/Mbps	
Output Dynamic Supply Current ⁹	$I_{DDO(D)}$		0.02		mA/Mbps	

- ¹ Output supply current values are with no output load present. See Figure 5 and Figure 6 for information on supply current variation with logic signal frequency. See the Power Consumption section for guidance on calculating the input and output supply currents for a given data rate and output load.
- ² The minimum pulse width is the shortest pulse width at which the specified pulse width distortion is guaranteed.
- ³ The maximum data rate is the fastest data rate at which the specified pulse width distortion is guaranteed.
- ⁴ t_{PHL} is measured from the 50% level of the falling edge of the V_i signal to the 50% level of the falling edge of the V_o signal. t_{PLH} is measured from the 50% level of the rising edge of the V_i signal to the 50% level of the rising edge of the V_o signal.
- ⁵ Because the input thresholds of the ADuM1100 are at voltages other than the 50% level of typical input signals, the measured propagation delay and pulse width distortion can be affected by slow input rise/fall times. See the Propagation Delay-Related Parameters section and Figure 14 through Figure 18 for information on the impact of given input rise/fall times on these parameters.
- ⁶ Pulse width distortion change vs. temperature is the absolute value of the change in pulse width distortion for a 1°C change in operating temperature.
- ⁷ t_{PSK1} is the magnitude of the worst-case difference in t_{PHL} and/or t_{PLH} that is measured between units at the same operating temperature and output load within the recommended operating conditions. t_{PSK2} is the magnitude of the worst-case difference in t_{PHL} and/or t_{PLH} that is measured between units at the same operating temperature, supply voltages, and output load within the recommended operating conditions.
- ⁸ CM_H is the maximum common-mode voltage slew rate that can be sustained while maintaining $V_o > 0.8 V_{DD2}$. CM_L is the maximum common-mode voltage slew rate that can be sustained while maintaining $V_o < 0.8 V$. The common-mode voltage slew rates apply to both rising and falling edges. The transient magnitude is the range over which the common mode is slewed.
- ⁹ Dynamic supply current is the incremental amount of supply current required for a 1 Mbps increase in signal data rate. See Figure 5 and Figure 6 for information on supply current variation with logic signal frequency. See the Power Consumption section for guidance on calculating the input and output supply currents for a given data rate and output load.

ELECTRICAL SPECIFICATIONS—3.3 V OPERATION

All voltages are relative to their respective ground. $3.0\text{ V} \leq V_{DD1} \leq 3.6\text{ V}$, $3.0\text{ V} \leq V_{DD2} \leq 3.6\text{ V}$. All minimum/maximum specifications apply over the entire recommended operation range, unless otherwise noted. All typical specifications are at $T_A = 25^\circ\text{C}$, $V_{DD1} = V_{DD2} = 3.3\text{ V}$.

Table 2.

Parameter	Symbol	Min	Typ	Max	Unit	Test Conditions
DC SPECIFICATIONS						
Input Supply Current	$I_{DD1(Q)}$		0.1	0.3	mA	$V_I = 0\text{ V}$ or V_{DD1}
Output Supply Current	$I_{DD2(Q)}$		0.005	0.04	mA	$V_I = 0\text{ V}$ or V_{DD1}
Input Supply Current (25 Mbps) (See Figure 5)	$I_{DD1(25)}$		2.0	2.8	mA	12.5 MHz logic signal frequency
Output Supply Current ¹ (25 Mbps) (See Figure 6)	$I_{DD2(25)}$		0.3	0.7	mA	12.5 MHz logic signal frequency
Input Supply Current (50 Mbps) (See Figure 5)	$I_{DD1(50)}$		4.0	6.0	mA	25 MHz logic signal frequency, ADuM1100BR/ADuM1100UR only
Output Supply Current ¹ (50 Mbps) (See Figure 6)	$I_{DD2(50)}$		1.2	1.6	mA	25 MHz logic signal frequency, ADuM1100BR/ADuM1100UR only
Input Current	I_I	-10	+0.01	+10	μA	$0\text{ V} \leq V_{IN} \leq V_{DD1}$
Logic High Output Voltage	V_{OH}	$V_{DD2} - 0.1$	3.3		V	$I_O = -20\text{ }\mu\text{A}$, $V_I = V_{IH}$
		$V_{DD2} - 0.5$	3.0		V	$I_O = -2.5\text{ mA}$, $V_I = V_{IH}$
Logic Low Output Voltage	V_{OL}		0.0	0.1	V	$I_O = 20\text{ }\mu\text{A}$, $V_I = V_{IH}$
			0.04	0.1	V	$I_O = 400\text{ }\mu\text{A}$, $V_I = V_{IH}$
			0.3	0.4	V	$I_O = 2.5\text{ mA}$, $V_I = V_{IH}$
SWITCHING SPECIFICATIONS						
For ADuM1100AR						
Minimum Pulse Width ²	PW			40	ns	$C_L = 15\text{ pF}$, CMOS signal levels
Maximum Data Rate ³		25			Mbps	$C_L = 15\text{ pF}$, CMOS signal levels
For ADuM1100BR/ADuM1100UR						
Minimum Pulse Width ²	PW		10	20	ns	$C_L = 15\text{ pF}$, CMOS signal levels
Maximum Data Rate ³		50	100		Mbps	$C_L = 15\text{ pF}$, CMOS signal levels
For All Grades						
Propagation Delay Time to Logic Low Output ^{4, 5} (See Figure 8)	t_{PHL}		14.5	28	ns	$C_L = 15\text{ pF}$, CMOS signal levels
Propagation Delay Time to Logic High Output ^{4, 5} (See Figure 8)	t_{PLH}		15.0	28	ns	$C_L = 15\text{ pF}$, CMOS signal levels
Pulse Width Distortion $ t_{PLH} - t_{PHL} $ ⁵ Change vs. Temperature ⁶	PWD		0.5	3	ns	$C_L = 15\text{ pF}$, CMOS signal levels
Propagation Delay Skew (Equal Temperature) ^{5, 7}	t_{PSK1}			15	ps/ $^\circ\text{C}$	$C_L = 15\text{ pF}$, CMOS signal levels
Propagation Delay Skew (Equal Temperature, Supplies) ^{5, 7}	t_{PSK2}			12	ns	$C_L = 15\text{ pF}$, CMOS signal levels
Output Rise/Fall Time	t_R, t_F		3		ns	$C_L = 15\text{ pF}$, CMOS signal levels
Common-Mode Transient Immunity at Logic Low/High Output ⁸	$ CM_L $, $ CM_H $	25	35		kV/ μs	$V_I = 0\text{ V}$ or V_{DD1} , $V_{CM} = 1000\text{ V}$, transient magnitude = 800 V
Refresh Rate	f_r		1.1		Mbps	
Input Dynamic Supply Current ⁹	$I_{DDI(D)}$		0.08		mA/Mbps	
Output Dynamic Supply Current ⁹	$I_{DDO(D)}$		0.04		mA/Mbps	

- ¹ Output supply current values are with no output load present. See Figure 5 and Figure 6 for information on supply current variation with logic signal frequency. See the Power Consumption section for guidance on calculating the input and output supply currents for a given data rate and output load.
- ² The minimum pulse width is the shortest pulse width at which the specified pulse width distortion is guaranteed.
- ³ The maximum data rate is the fastest data rate at which the specified pulse width distortion is guaranteed.
- ⁴ t_{PHL} is measured from the 50% level of the falling edge of the V_i signal to the 50% level of the falling edge of the V_o signal. t_{PLH} is measured from the 50% level of the rising edge of the V_i signal to the 50% level of the rising edge of the V_o signal.
- ⁵ Because the input thresholds of the ADuM1100 are at voltages other than the 50% level of typical input signals, the measured propagation delay and pulse width distortion can be affected by slow input rise/fall times. See the Propagation Delay-Related Parameters section and Figure 14 through Figure 18 for information on the impact of given input rise/fall times on these parameters.
- ⁶ Pulse width distortion change vs. temperature is the absolute value of the change in pulse width distortion for a 1°C change in operating temperature.
- ⁷ t_{PSK1} is the magnitude of the worst-case difference in t_{PHL} and/or t_{PLH} that is measured between units at the same operating temperature and output load within the recommended operating conditions. t_{PSK2} is the magnitude of the worst-case difference in t_{PHL} and/or t_{PLH} that is measured between units at the same operating temperature, supply voltages, and output load within the recommended operating conditions.
- ⁸ CM_H is the maximum common-mode voltage slew rate that can be sustained while maintaining $V_o > 0.8 V_{DD2}$. CM_L is the maximum common-mode voltage slew rate that can be sustained while maintaining $V_o < 0.8 V$. The common-mode voltage slew rates apply to both rising and falling edges. The transient magnitude is the range over which the common mode is slewed.
- ⁹ Dynamic supply current is the incremental amount of supply current required for a 1 Mbps increase in signal data rate. See Figure 5 and Figure 6 for information on supply current variation with logic signal frequency. See the Power Consumption section for guidance on calculating the input and output supply currents for a given data rate and output load.

ELECTRICAL SPECIFICATIONS—MIXED 5 V/3 V OR 3 V/5 V OPERATION

All voltages are relative to their respective ground. 5 V/3 V operation: $4.5\text{ V} \leq V_{DD1} \leq 5.5\text{ V}$, $3.0\text{ V} \leq V_{DD2} \leq 3.6\text{ V}$. 3 V/5 V operation: $3.0\text{ V} \leq V_{DD1} \leq 3.6\text{ V}$, $4.5\text{ V} \leq V_{DD2} \leq 5.5\text{ V}$. All minimum/maximum specifications apply over the entire recommended operation range, unless otherwise noted. All typical specifications are at $T_A = 25^\circ\text{C}$, $V_{DD1} = 3.3\text{ V}$, $V_{DD2} = 5\text{ V}$ or $V_{DD1} = 5\text{ V}$, $V_{DD2} = 3.3\text{ V}$.

Table 3.

Parameter	Symbol	Min	Typ	Max	Unit	Test Conditions
DC SPECIFICATIONS						
Input Supply Current, Quiescent	$I_{DD1(Q)}$					
5 V/3 V Operation			0.3	0.8	mA	
3 V/5 V Operation			0.1	0.3	mA	
Output Supply Current, Quiescent	$I_{DDO(Q)}$					
5 V/3 V Operation			0.005	0.04	mA	
3 V/5 V Operation			0.01	0.06	mA	
Input Supply Current, 25 Mbps	$I_{DD1(25)}$					
5 V/3 V Operation			2.2	3.5	mA	12.5 MHz logic signal frequency
3 V/5 V Operation			2.0	2.8	mA	12.5 MHz logic signal frequency
Output Supply Current ¹ , 25 Mbps	$I_{DDO(25)}$					
5 V/3 V Operation			0.3	0.7	mA	12.5 MHz logic signal frequency
3 V/5 V Operation			0.5	1.0	mA	12.5 MHz logic signal frequency
Input Supply Current, 50 Mbps	$I_{DD1(50)}$					
5 V/3 V Operation			4.5	7.0	mA	25 MHz logic signal frequency
3 V/5 V Operation			4.0	6.0	mA	25 MHz logic signal frequency
Output Supply Current ¹ , 50 Mbps	$I_{DDO(50)}$					
5 V/3 V Operation			1.2	1.6	mA	25 MHz logic signal frequency
3 V/5 V Operation			1.0	1.5	mA	25 MHz logic signal frequency
Input Currents	I_{IA}	-10	+0.01	+10	μA	$0\text{ V} \leq V_{IA}, V_{IB}, V_{IC}, V_{ID} \leq V_{DD1}$ or V_{DD2}
Logic High Output Voltage	V_{OH}	$V_{DD2} - 0.1$	3.3		V	$I_O = -20\text{ }\mu\text{A}$, $V_I = V_{IH}$
5 V/3 V Operation		$V_{DD2} - 0.5$	3.0		V	$I_O = -2.5\text{ mA}$, $V_I = V_{IH}$
Logic Low Output Voltage	V_{OL}		0.0	0.1	V	$I_O = 20\text{ }\mu\text{A}$, $V_I = V_{IL}$
5 V/3 V Operation			0.04	0.1	V	$I_O = 400\text{ }\mu\text{A}$, $V_I = V_{IL}$
Logic High Output Voltage	V_{OH}	$V_{DD2} - 0.1$	5.0		V	$I_O = -20\text{ }\mu\text{A}$, $V_I = V_{IH}$
3 V/5 V Operation		$V_{DD2} - 0.8$	4.6		V	$I_O = -4\text{ mA}$, $V_I = V_{IH}$
Logic Low Output Voltage	V_{OL}		0.0	0.1	V	$I_O = 20\text{ }\mu\text{A}$, $V_I = V_{IL}$
3 V/5 V Operation			0.03	0.1	V	$I_O = 400\text{ }\mu\text{A}$, $V_I = V_{IL}$
			0.3	0.8	V	$I_O = 4\text{ mA}$, $V_I = V_{IL}$
SWITCHING SPECIFICATIONS						
For ADuM1100AR						
Minimum Pulse Width ²	PW			40	ns	$C_L = 15\text{ pF}$, CMOS signal levels
Maximum Data Rate ³		25			Mbps	$C_L = 15\text{ pF}$, CMOS signal levels
For ADuM1100BR/ADuM1100UR						
Minimum Pulse Width ²	PW			20	ns	$C_L = 15\text{ pF}$, CMOS signal levels
Maximum Data Rate ³		50			Mbps	$C_L = 15\text{ pF}$, CMOS signal levels
For All Grades						
Propagation Delay Time to Logic Low/High Output ^{4, 5}	t_{PHL} , t_{PLH}					
5 V/3 V Operation (See Figure 9)			13	21	ns	$C_L = 15\text{ pF}$, CMOS signal levels
3 V/5 V Operation (See Figure 10)			16	26	ns	$C_L = 15\text{ pF}$, CMOS signal levels

Parameter	Symbol	Min	Typ	Max	Unit	Test Conditions
Pulse Width Distortion, $ t_{PLH} - t_{PHL} ^5$	PWD					
5 V/3 V Operation			0.5	2	ns	$C_L = 15$ pF, CMOS signal levels
3 V/5 V Operation			0.5	3	ns	$C_L = 15$ pF, CMOS signal levels
Change in Pulse Width Distortion vs. Temperature ⁶						
5 V/3 V Operation			3		ps/°C	$C_L = 15$ pF, CMOS signal levels
3 V/5 V Operation			10		ps/°C	$C_L = 15$ pF, CMOS signal levels
Propagation Delay Skew (Equal Temperature) ^{5,7}	t_{PSK1}					
5 V/3 V Operation				12	ns	$C_L = 15$ pF, CMOS signal levels
3 V/5 V Operation				15	ns	$C_L = 15$ pF, CMOS signal levels
Propagation Delay Skew (Equal Temperature, Supplies) ^{5,7}	t_{PSK2}					
5 V/3 V Operation				9	ns	$C_L = 15$ pF, CMOS signal levels
3 V/5 V Operation				12	ns	$C_L = 15$ pF, CMOS signal levels
Output Rise/Fall Time (10% to 90%)	t_R, t_F		3		ns	$C_L = 15$ pF, CMOS signal levels
Common-Mode Transient Immunity at Logic Low/High Output ⁸	$ CM_L , CM_H $	25	35		kV/μs	$V_I = 0$ V or $V_{DD1}, V_{CM} = 1000$ V, transient magnitude = 800 V
Refresh Rate	f_r					
5 V/3 V Operation			1.2		Mbps	
3 V/5 V Operation			1.1		Mbps	
Input Dynamic Supply Current ⁹	C_{PD1}					
5 V/3 V Operation			0.09		mA/Mbps	
3 V/5 V Operation			0.08		mA/Mbps	
Output Dynamic Supply Current ⁹	C_{PD2}					
5 V/3 V Operation			0.04		mA/Mbps	
3 V/5 V Operation			0.02		mA/Mbps	

¹ Output supply current values are with no output load present. See Figure 5 and Figure 6 for information on supply current variation with logic signal frequency. See the Power Consumption section for guidance on calculating the input and output supply currents for a given data rate and output load.

² The minimum pulse width is the shortest pulse width at which the specified pulse width distortion is guaranteed.

³ The maximum data rate is the fastest data rate at which the specified pulse width distortion is guaranteed.

⁴ t_{PHL} is measured from the 50% level of the falling edge of the V_I signal to the 50% level of the falling edge of the V_O signal. t_{PLH} is measured from the 50% level of the rising edge of the V_I signal to the 50% level of the rising edge of the V_O signal.

⁵ Because the input thresholds of the ADuM1100 are at voltages other than the 50% level of typical input signals, the measured propagation delay and pulse width distortion can be affected by slow input rise/fall times. See the Propagation Delay-Related Parameters section and Figure 14 through Figure 18 for information on the impact of given input rise/fall times on these parameters.

⁶ Pulse width distortion change vs. temperature is the absolute value of the change in pulse width distortion for a 1°C change in operating temperature.

⁷ t_{PSK1} is the magnitude of the worst-case difference in t_{PHL} and/or t_{PLH} that is measured between units at the same operating temperature and output load within the recommended operating conditions. t_{PSK2} is the magnitude of the worst-case difference in t_{PHL} and/or t_{PLH} that is measured between units at the same operating temperature, supply voltages, and output load within the recommended operating conditions.

⁸ CM_H is the maximum common-mode voltage slew rate that can be sustained while maintaining $V_O > 0.8 V_{DD2}$. CM_L is the maximum common-mode voltage slew rate that can be sustained while maintaining $V_O < 0.8$ V. The common-mode voltage slew rates apply to both rising and falling edges. The transient magnitude is the range over which the common mode is slewed.

⁹ Dynamic supply current is the incremental amount of supply current required for a 1 Mbps increase in signal data rate. See Figure 5 and Figure 6 for information on supply current variation with logic signal frequency. See the Power Consumption section for guidance on calculating the input and output supply currents for a given data rate and output load.

PACKAGE CHARACTERISTICS

Table 4.

Parameter	Symbol	Min	Typ	Max	Unit	Test Conditions
Resistance (Input-to-Output) ¹	R _{I-O}		10 ¹²		Ω	f = 1 MHz
Capacitance (Input-to-Output) ¹	C _{I-O}		1.0		pF	
Input Capacitance ²	C _I		4.0		pF	Thermocouple located at center of package underside
IC Junction-to-Case Thermal Resistance, Side 1	θ _{JCI}		46		°C/W	
IC Junction-to-Case Thermal Resistance, Side 2	θ _{JCO}		41		°C/W	
Package Power Dissipation	P _{PD}			240	mW	

¹ The device is considered a 2-terminal device; Pin 1, Pin 2, Pin 3, and Pin 4 are shorted together, and Pin 5, Pin 6, Pin 7, and Pin 8 are shorted together.

² Input capacitance is measured at Pin 2 (Vi).

REGULATORY INFORMATION

The ADuM1100 is approved by the following organizations.

Table 5.

UL	CSA	VDE
Recognized under 1577 component recognition program ¹	Approved under CSA Component Acceptance Notice #5A	Certified according to DIN V VDE V 0884-10 (VDE V 0884-10):2006-12 ²
Single/basic insulation, 2500 V rms isolation voltage	Basic insulation per CSA 60950-1-03 and IEC 60950-1, 400 V rms (565 V peak) maximum working voltage	Reinforced insulation, 560 V peak
File E214100	File 205078	File 2471900-4880-0001

¹ In accordance with UL 1577, each ADuM1100 is proof tested by applying an insulation test voltage ≥3000 V rms for 1 sec (current leakage detection limit = 5 μA).

² In accordance with DIN V VDE V 0884-10, each ADuM1100 is proof tested by applying an insulation test voltage ≥1050 V peak for 1 sec (partial discharge detection limit = 5 pC). The * marking branded on the component designates DIN V VDE V 0884-10 approval.

INSULATION AND SAFETY-RELATED SPECIFICATIONS

Table 6.

Parameter	Symbol	Value	Unit	Conditions
Minimum External Air Gap (Clearance)	L(I01)	4.90 min	mm	Measured from input terminals to output terminals, shortest distance through air
Minimum External Tracking (Creepage)	L(I02)	4.01 min	mm	Measured from input terminals to output terminals, shortest distance path along body
Minimum Internal Gap (Internal Clearance)		0.016 min	mm	Insulation distance through insulation
Tracking Resistance (Comparative Tracking Index)	CTI	>175	V	DIN IEC 112/VDE 0303 Part 1
Isolation Group		IIIa		Material Group (DIN VDE 0110, 1/89, Table I)
Maximum Working Voltage Compatible with 50 Years Service Life	V _{IORM}	565	V peak	Continuous peak voltage across the isolation barrier

DIN V VDE V 0884-10 (VDE V 0884-10):2006-12 INSULATION CHARACTERISTICS

This isolator is suitable for reinforced isolation only within the safety limit data. Maintenance of the safety data is ensured by means of protective circuits. The asterisk (*) marking on the package denotes DIN V VDE V 0884-10 approval for 560 V peak working voltage.

Table 7.

Description	Conditions	Symbol	Characteristic	Unit
Installation Classification per DIN VDE 0110 For Rated Mains Voltage ≤ 150 V rms For Rated Mains Voltage ≤ 300 V rms For Rated Mains Voltage ≤ 400 V rms			I to IV I to III I to II	
Climatic Classification			40/105/21	
Pollution Degree per DIN VDE 0110, Table 1			2	
Maximum Working Insulation Voltage		V_{IORM}	560	V peak
Input-to-Output Test Voltage, Method B1	$V_{IORM} \times 1.875 = V_{PR}$, 100% production test, $t_m = 1$ sec, partial discharge < 5 pC	V_{PR}	1050	V peak
Input-to-Output Test Voltage, Method A	$V_{IORM} \times 1.6 = V_{PR}$, $t_m = 60$ sec, partial discharge < 5 pC	V_{PR}		
After Environmental Tests Subgroup 1			896	V peak
After Input and/or Safety Test Subgroup 2 and Subgroup 3	$V_{IORM} \times 1.2 = V_{PR}$, $t_m = 60$ sec, partial discharge < 5 pC		672	V peak
Highest Allowable Overvoltage	Transient overvoltage, $t_{TR} = 10$ seconds	V_{TR}	4000	V peak
Safety-Limiting Values	Maximum value allowed in the event of a failure (see Figure 2)			
Case Temperature		T_S	150	°C
Side 1 Current		I_{S1}	160	mA
Side 2 Current		I_{S2}	170	mA
Insulation Resistance at T_S	$V_{IO} = 500$ V	R_S	>10 ⁹	Ω

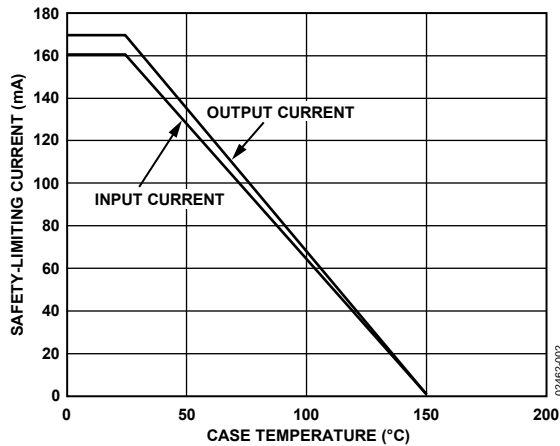

Figure 2. Thermal Derating Curve, Dependence of Safety-Limiting Values with Case Temperature per DIN V VDE V 0884-10

RECOMMENDED OPERATING CONDITIONS

Table 8.

Parameter	Symbol	Min	Max	Unit
Operating Temperature				
ADuM1100AR/ADuM1100BR	T_A	-40	+105	°C
ADuM1100UR	T_A	-40	+125	°C
Supply Voltages ¹	V_{DD1} , V_{DD2}	3.0	5.5	V
Logic High Input Voltage, 5 V Operation ^{1, 2} (See Figure 11 and Figure 12)	V_{IH}	2.0	V_{DD1}	V
Logic Low Input Voltage, 5 V Operation ^{1, 2} (See Figure 11 and Figure 12)	V_{IL}	0.0	0.8	V
Logic High Input Voltage, 3.3 V Operation ^{1, 2} (See Figure 11 and Figure 12)	V_{IH}	1.5	V_{DD1}	V
Logic Low Input Voltage, 3.3 V Operation ^{1, 2} (See Figure 11 and Figure 12)	V_{IL}	0.0	0.5	V
Input Signal Rise and Fall Times			1.0	ms

¹ All voltages are relative to their respective ground.

² Input switching thresholds have 300 mV of hysteresis. See the Method of Operation, DC Correctness, and Magnetic Field Immunity section, Figure 19, and Figure 20 for information on immunity to external magnetic fields.

ABSOLUTE MAXIMUM RATINGS

Table 9.

Parameter	Symbol	Min	Max	Unit
Storage Temperature	T _{ST}	-55	+150	°C
Ambient Operating Temperature	T _A	-40	+125	°C
Supply Voltages ¹	V _{DD1} , V _{DD2}	-0.5	+6.5	V
Input Voltage ¹	V _I	-0.5	V _{DD1} + 0.5	V
Output Voltage ¹	V _O	-0.5	V _{DD2} + 0.5	V
Average Current, per Pin ²				
Temperature ≤ 105°C		-25	+25	mA
Temperature ≤ 125°C				
Input Current		-7	+7	mA
Output Current		-20	+20	mA
Common-Mode Transients ³		-100	+100	kV/μs

¹ All voltages are relative to their respective ground.

² See Figure 2 for information on maximum allowable current for various temperatures.

³ Refers to common-mode transients across the insulation barrier. Common-mode transients exceeding the Absolute Maximum Rating may cause latch-up or permanent damage.

Stresses above those listed under Absolute Maximum Ratings may cause permanent damage to the device. This is a stress rating only; functional operation of the device at these or any other conditions above those indicated in the operational section of this specification is not implied. Exposure to absolute maximum rating conditions for extended periods may affect device reliability.

ESD CAUTION



ESD (electrostatic discharge) sensitive device. Charged devices and circuit boards can discharge without detection. Although this product features patented or proprietary protection circuitry, damage may occur on devices subjected to high energy ESD. Therefore, proper ESD precautions should be taken to avoid performance degradation or loss of functionality.

Table 10. Truth Table (Positive Logic)

V _I Input	V _{DD1} State	V _{DD2} State	V _O Output
H	Powered	Powered	H
L	Powered	Powered	L
X	Unpowered	Powered	H ¹
X	Powered	Unpowered	X ¹

¹ V_O returns to V_I state within 1 μs of power restoration.

Figure 3 shows the package branding. The asterisk (*) is the DIN EN 60747-5-2 mark, R is the package designator (R denotes SOIC_N), YYWW is the date code, and XXXXXX is the lot code.

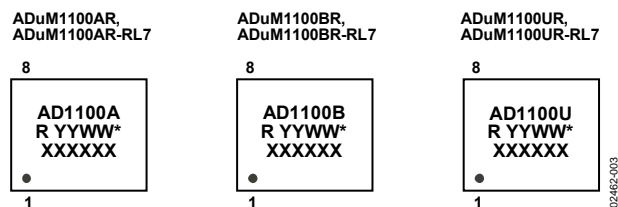
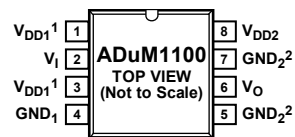

Figure 3. Package Branding

PIN CONFIGURATION AND FUNCTION DESCRIPTIONS



¹PIN 1 AND PIN 3 ARE INTERNALLY CONNECTED. EITHER OR BOTH MAY BE USED FOR V_{DD1} .
²PIN 5 AND PIN 7 ARE INTERNALLY CONNECTED. EITHER OR BOTH MAY BE USED FOR GND_2 .

02482-004

Figure 4. Pin Configuration

Table 11. Pin Function Descriptions

Pin No.	Mnemonic	Description
1	V_{DD1}	Input Supply Voltage, 3.0 V to 5.5 V.
2	V_I	Logic Input.
3	V_{DD1}	Input Supply Voltage, 3.0 V to 5.5 V.
4	GND_1	Input Ground Reference.
5	GND_2	Output Ground Reference.
6	V_O	Logic Output.
7	GND_2	Output Ground Reference.
8	V_{DD2}	Output Supply Voltage, 3.0 V to 5.5 V.

TYPICAL PERFORMANCE CHARACTERISTICS

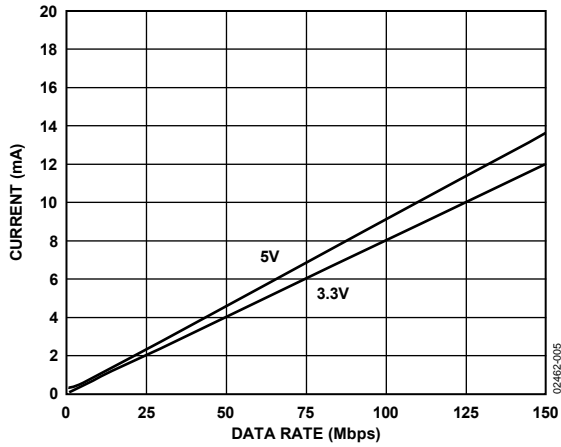

Figure 5. Typical Input Supply Current vs. Logic Signal Frequency for 5 V and 3.3 V Operation

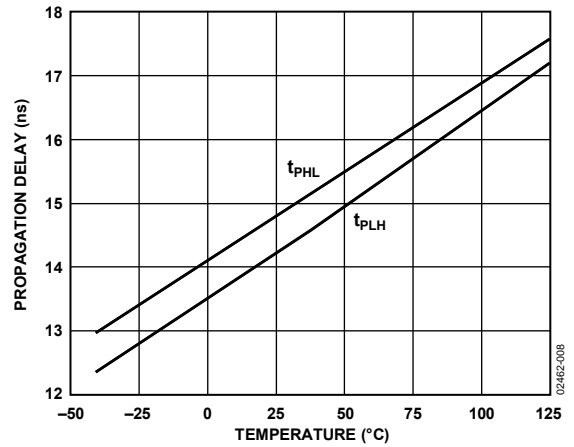

Figure 8. Typical Propagation Delays vs. Temperature, 3.3 V Operation

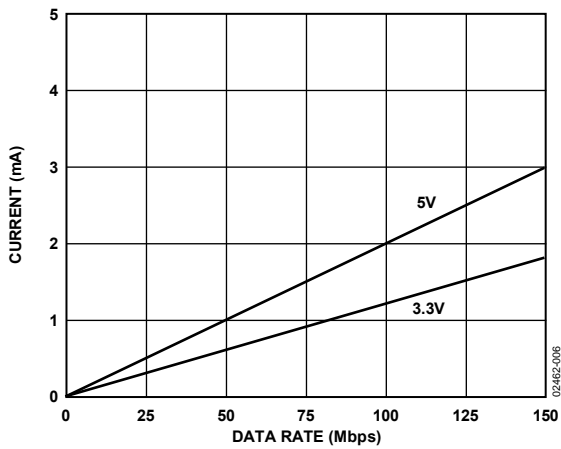

Figure 6. Typical Output Supply Current vs. Logic Signal Frequency for 5 V and 3.3 V Operation

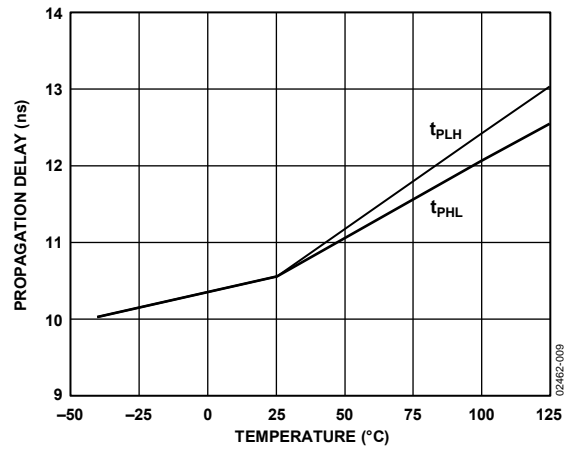

Figure 9. Typical Propagation Delays vs. Temperature, 5 V/3 V Operation

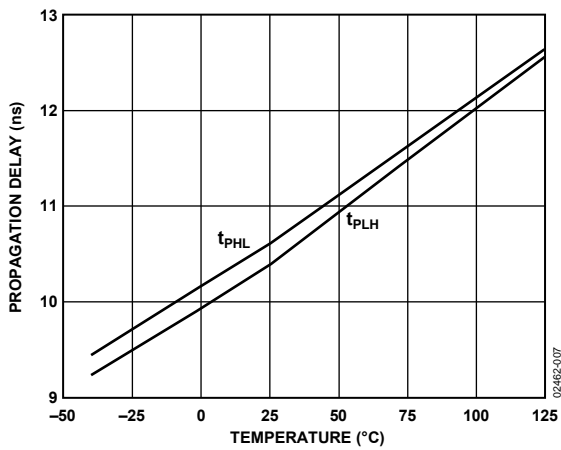

Figure 7. Typical Propagation Delays vs. Temperature, 5 V Operation

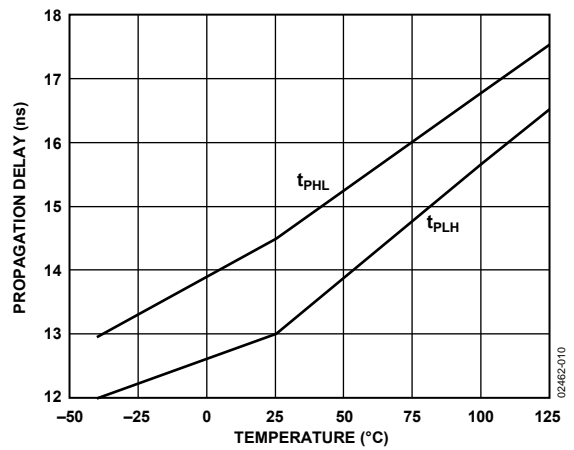

Figure 10. Typical Propagation Delays vs. Temperature, 3 V/5 V Operation

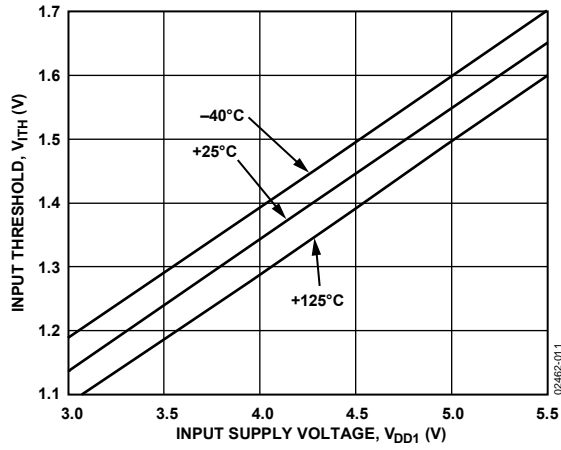

Figure 11. Typical Input Voltage Switching Threshold, Low-to-High Transition

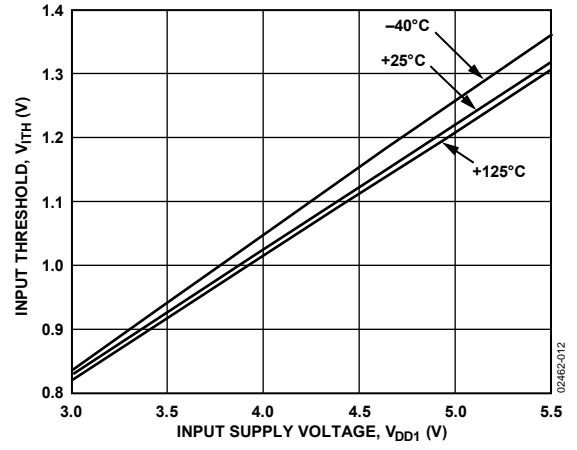

Figure 12. Typical Input Voltage Switching Threshold, High-to-Low Transition

APPLICATION INFORMATION

PC BOARD LAYOUT

The ADuM1100 digital isolator requires no external interface circuitry for the logic interfaces. A bypass capacitor is recommended at the input and output supply pins. The input bypass capacitor can conveniently be connected between Pin 3 and Pin 4 (see Figure 13). Alternatively, the bypass capacitor can be located between Pin 1 and Pin 4. The output bypass capacitor can be connected between Pin 7 and Pin 8 or Pin 5 and Pin 8. The capacitor value should be between 0.01 μF and 0.1 μF . The total lead length between both ends of the capacitor and the power supply pins should not exceed 20 mm.

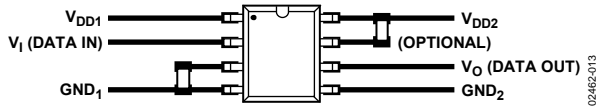

Figure 13. Recommended Printed Circuit Board Layout

See the [AN-1109 Application Note](#) for board layout guidelines.

PROPAGATION DELAY-RELATED PARAMETERS

Propagation delay time describes the length of time it takes for a logic signal to propagate through a component. Propagation delay time to logic low output and propagation delay time to logic high output refer to the duration between an input signal transition and the respective output signal transition (see Figure 14).

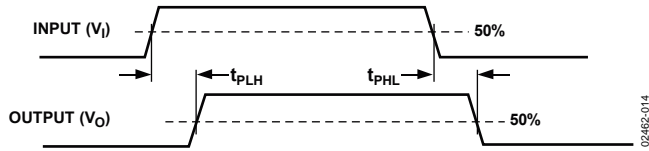

Figure 14. Propagation Delay Parameters

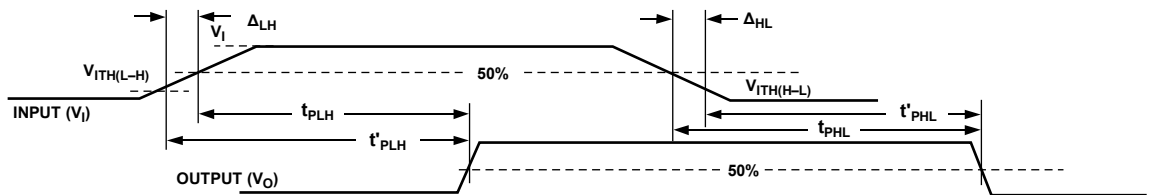

Figure 15. Impact of Input Rise/Fall Time on Propagation Delay

Pulse width distortion is the maximum difference between t_{PLH} and t_{PHL} and provides an indication of how accurately the input signal's timing is preserved in the component's output signal. Propagation delay skew is the difference between the minimum and maximum propagation delay values among multiple ADuM1100 components operated at the same operating temperature and having the same output load.

Depending on the input signal rise/fall time, the measured propagation delay based on the input 50% level can vary from the true propagation delay of the component (as measured from its input switching threshold). This is because the input threshold, as is the case with commonly used optocouplers, is at a different voltage level than the 50% point of typical input signals. This propagation delay difference is given by

$$\Delta_{LH} = t'_{PLH} - t_{PLH} = (t_r/0.8 V_I)(0.5 V_I - V_{ITH(L-H)})$$

$$\Delta_{HL} = t'_{PHL} - t_{PHL} = (t_f/0.8 V_I)(0.5 V_I - V_{ITH(H-L)})$$

where:

t_{PLH} and t_{PHL} are the propagation delays as measured from the input 50% level.

t'_{PLH} and t'_{PHL} are the propagation delays as measured from the input switching thresholds.

t_r and t_f are the input 10% to 90% rise/fall times.

V_I is the amplitude of the input signal (0 V to V_I levels assumed).

$V_{ITH(L-H)}$ and $V_{ITH(H-L)}$ are the input switching thresholds.

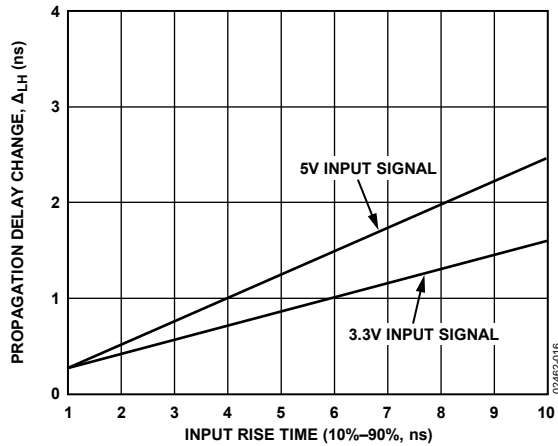

Figure 16. Typical Propagation Delay Change Due to Input Rise Time Variation (for $V_{DD1} = 3.3\text{ V}$ and 5 V)

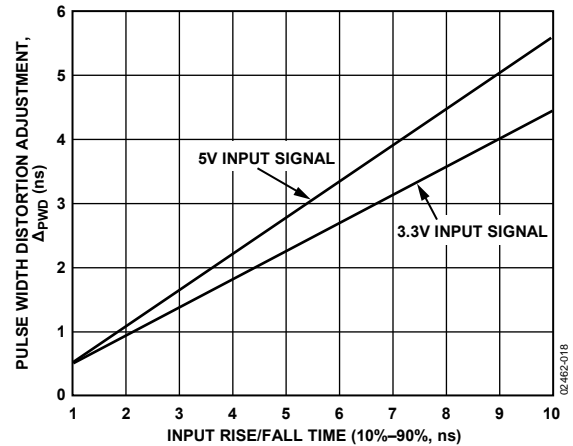

Figure 18. Typical Pulse Width Distortion Adjustment Due to Input Rise/Fall Time Variation (for $V_{DD1} = 3.3\text{ V}$ and 5 V)

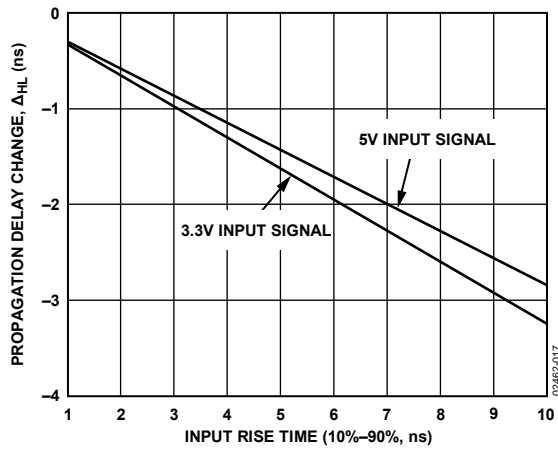

Figure 17. Typical Propagation Delay Change Due to Input Fall Time Variation (for $V_{DD1} = 3.3\text{ V}$ and 5 V)

The impact of the slower input edge rates can also affect the measured pulse width distortion as based on the input 50% level. This impact can either increase or decrease the apparent pulse width distortion depending on the relative magnitudes of t_{PHL} , t_{PLH} , and PWD . The case of interest here is the condition that leads to the largest increase in pulse width distortion. The change in this case is given by

$$\Delta_{PWD} = PWD' - PWD = \Delta_{LH} - \Delta_{HL} = (t/0.8 V_i)(V - V_{ITH(L-H)} - V_{ITH(H-L)}), \text{ (for } t = t_R = t_F)$$

where:

$$PWD = |t_{PLH} - t_{PHL}|$$

$$PWD' = |t'_{PLH} - t'_{PHL}|$$

This adjustment in pulse width distortion is plotted as a function of input rise/fall time in Figure 18.

METHOD OF OPERATION, DC CORRECTNESS, AND MAGNETIC FIELD IMMUNITY

The two coils in Figure 1 act as a pulse transformer. Positive and negative logic transitions at the isolator input cause narrow (2 ns) pulses to be sent via the transformer to the decoder. The decoder is bistable and therefore either set or reset by the pulses indicating input logic transitions. In the absence of logic transitions at the input for more than $\sim 1\ \mu\text{s}$, a periodic update pulse of the appropriate polarity is sent to ensure dc correctness at the output. If the decoder receives none of these update pulses for more than about $5\ \mu\text{s}$, the input side is assumed to be unpowered or nonfunctional, in which case the isolator output is forced to a logic high state by the watchdog timer circuit.

The limitation on the magnetic field immunity of the ADuM1100 is set by the condition in which induced voltage in the transformer's receiving coil is sufficiently large to either falsely set or reset the decoder. The analysis that follows defines the conditions under which this can occur. The 3.3 V operating condition of the ADuM1100 is examined because it represents the most susceptible mode of operation.

The pulses at the transformer output are greater than 1.0 V in amplitude. The decoder has sensing thresholds at about 0.5 V, therefore establishing a 0.5 V margin in which induced voltages can be tolerated. The voltage induced across the receiving coil is given by

$$V = (-d\beta/dt) \sum \pi r_n^2, n = 1, 2, \dots, N$$

where:

β is the magnetic flux density (gauss).

N is the number of turns in the receiving coil.

r_n is the radius of the n th turn in the receiving coil (cm).

Given the geometry of the receiving coil in the ADuM1100 and an imposed requirement that the induced voltage be at most 50% of the 0.5 V margin at the decoder, a maximum allowable magnetic field is calculated, as shown in Figure 19.

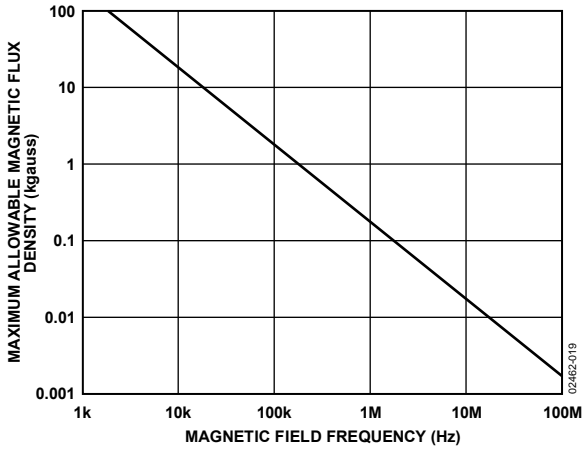

Figure 19. Maximum Allowable External Magnetic Field

For example, at a magnetic field frequency of 1 MHz, the maximum allowable magnetic field of 0.2 kgauss induces a voltage of 0.25 V at the receiving coil. This is about 50% of the sensing threshold and does not cause a faulty output transition. Similarly, if such an event were to occur during a transmitted pulse (and was of the worst-case polarity), it would reduce the received pulse from >1.0 V to 0.75 V, still well above the 0.5 V sensing threshold of the decoder.

The preceding magnetic flux density values correspond to specific current magnitudes at given distances away from the ADuM1100 transformers. Figure 20 expresses these allowable current magnitudes as a function of frequency for selected distances. As can be seen, the ADuM1100 is extremely immune and can be affected only by extremely large currents operated at high frequency and very close to the component. For the 1 MHz example noted, one would have to place a current of 0.5 kA 5 mm away from the ADuM1100 to affect the component's operation.

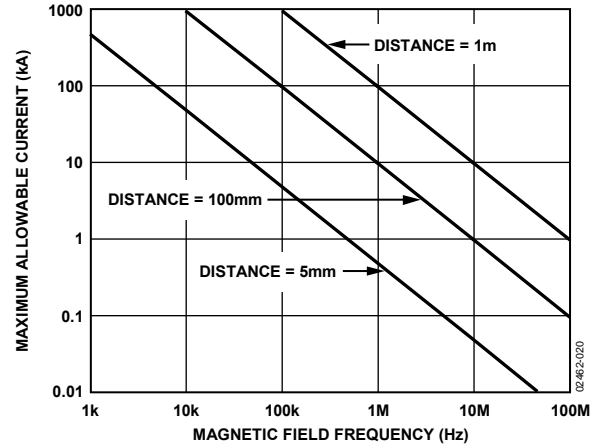

Figure 20. Maximum Allowable Current for Various Current-to-ADuM1100 Spacings

Note that at combinations of strong magnetic field and high frequency, any loops formed by printed circuit board traces could induce sufficiently large error voltages to trigger the thresholds of succeeding circuitry. Care should be taken in the layout of such traces to avoid this possibility.

POWER CONSUMPTION

The supply current of the ADuM1100 isolator is a function of the supply voltage, the input data rate, and the output load.

The input supply current is given by

$$I_{DDI} = I_{DDI(Q)} \quad f \leq 0.5f_r$$

$$I_{DDI} = I_{DDI(D)} \times (2f - f_r) + I_{DDI(Q)} \quad f > 0.5f_r$$

The output supply current is given by

$$I_{DDO} = I_{DDO(Q)} \quad f \leq 0.5f_r$$

$$I_{DDO} = (I_{DDO(D)} + (0.5 \times 10^{-3}) \times C_L V_{DDO}) \times (2f - f_r) + I_{DDO(Q)} \quad f > 0.5f_r$$

where:

$I_{DDI(D)}$, $I_{DDO(D)}$ are the input and output dynamic supply currents per channel (mA/Mbps).

C_L is the output load capacitance (pF).

V_{DDO} is the output supply voltage (V).

f is the input logic signal frequency (MHz, half the input data rate, NRZ signaling).

f_r is the input stage refresh rate (Mbps).

$I_{DDI(Q)}$, $I_{DDO(Q)}$ are the specified input and output quiescent supply currents (mA).

OUTLINE DIMENSIONS

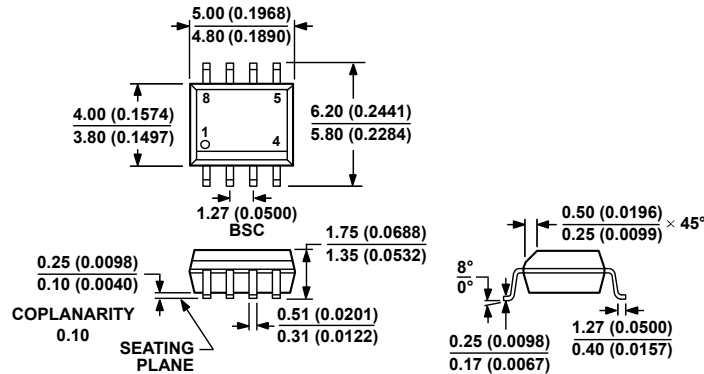

COMPLIANT TO JEDEC STANDARDS MS-012-AA
 CONTROLLING DIMENSIONS ARE IN MILLIMETERS; INCH DIMENSIONS
 (IN PARENTHESES) ARE ROUNDED-OFF MILLIMETER EQUIVALENTS FOR
 REFERENCE ONLY AND ARE NOT APPROPRIATE FOR USE IN DESIGN.

012407-A

Figure 21. 8-Lead Standard Small Outline Package [SOIC_N]
 Narrow Body (R-8)
 Dimensions shown in millimeters and (inches)

ORDERING GUIDE

Model ¹	Temperature Range	Maximum Data Rate (Mbps)	Minimum Pulse Width (ns)	Package Description	Package Option
ADuM1100AR	-40°C to +105°C	25	40	8-Lead SOIC_N	R-8
ADuM1100AR-RL7	-40°C to +105°C	25	40	8-Lead SOIC_N, 1,000 Piece Reel	R-8
ADuM1100ARZ	-40°C to +105°C	25	40	8-Lead SOIC_N	R-8
ADuM1100ARZ-RL7	-40°C to +105°C	25	40	8-Lead SOIC_N, 1,000 Piece Reel	R-8
ADuM1100BR	-40°C to +105°C	100	10	8-Lead SOIC_N	R-8
ADuM1100BR-RL7	-40°C to +105°C	100	10	8-Lead SOIC_N, 1,000 Piece Reel	R-8
ADuM1100BRZ	-40°C to +105°C	100	10	8-Lead SOIC_N	R-8
ADuM1100BRZ-RL7	-40°C to +105°C	100	10	8-Lead SOIC_N, 1,000 Piece Reel	R-8
ADuM1100UR	-40°C to +125°C	100	10	8-Lead SOIC_N	R-8
ADuM1100UR-RL7	-40°C to +125°C	100	10	8-Lead SOIC_N, 1,000 Piece Reel	R-8
ADuM1100URZ	-40°C to +125°C	100	10	8-Lead SOIC_N	R-8
ADuM1100URZ-RL7	-40°C to +125°C	100	10	8-Lead SOIC_N, 1,000 Piece Reel	R-8

¹ Z = RoHS Compliant Part.

NOTES



Стандарт Электрон Связь

Мы молодая и активно развивающаяся компания в области поставок электронных компонентов. Мы поставляем электронные компоненты отечественного и импортного производства напрямую от производителей и с крупнейших складов мира.

Благодаря сотрудничеству с мировыми поставщиками мы осуществляем комплексные и плановые поставки широчайшего спектра электронных компонентов.

Собственная эффективная логистика и склад в обеспечивает надежную поставку продукции в точно указанные сроки по всей России.

Мы осуществляем техническую поддержку нашим клиентам и предпродажную проверку качества продукции. На все поставляемые продукты мы предоставляем гарантию .

Осуществляем поставки продукции под контролем ВП МО РФ на предприятия военно-промышленного комплекса России , а также работаем в рамках 275 ФЗ с открытием отдельных счетов в уполномоченном банке. Система менеджмента качества компании соответствует требованиям ГОСТ ISO 9001.

Минимальные сроки поставки, гибкие цены, неограниченный ассортимент и индивидуальный подход к клиентам являются основой для выстраивания долгосрочного и эффективного сотрудничества с предприятиями радиоэлектронной промышленности, предприятиями ВПК и научно-исследовательскими институтами России.

С нами вы становитесь еще успешнее!

Наши контакты:

Телефон: +7 812 627 14 35

Электронная почта: sales@st-electron.ru

Адрес: 198099, Санкт-Петербург,
Промышленная ул, дом № 19, литера Н,
помещение 100-Н Офис 331