

Dual Pair Anti-Parallel Non-Magnetic PIN 5 - 400 MHz

Rev. V1

Features

- Designed for MRI applications
- Non-Magnetic Surface Mount Package
- Anti-Parallel Self Bias Configuration
- $C_T = 3.0 \text{ pF}$, $R_P = 10 \text{ k}\Omega$, $V_B = 80 \text{ V}$
- > 50 W CW Incident Power Handling @ 400 MHz
- Lead-Free 4 mm 8-lead HQFN Package
- Halogen-Free “Green” Mold Compound
- RoHS* Compliant and 260°C Reflow Compatible

Description

The MADP-011048 acts as a passive switch using silicon PIN diodes in a non-magnetic surface mount package. There are two sets of diode pairs constructed in an anti-parallel configuration that operate from 5 to 400 MHz.

The two pairs of diodes are arranged in an electrically isolated anti-parallel configuration. The diode pair with anode on Pin 1 and cathode on Pin 6 will be referenced as D1 and the diode pair with anode on Pin 5 and cathode on Pin 2 will be referenced as D2.

The MADP-011048 is well suited for MRI passive switching applications. The PIN diodes become a high Q R-C network under small signal and behave as an effective passive rectifier or short circuit under high RF signal to tune and de-tune the resonant MRI tank circuit. The anti-parallel doublet configuration provides efficient power handling.

Ordering Information^{1,2}

Part Number	Package
MADP-011048-TR3000	3000 Piece Reel
MADP-011048-000SMB	Sample Board

1. Reference Application Note M513 for reel size information.
2. All sample boards include 5 loose parts.

Functional Schematic

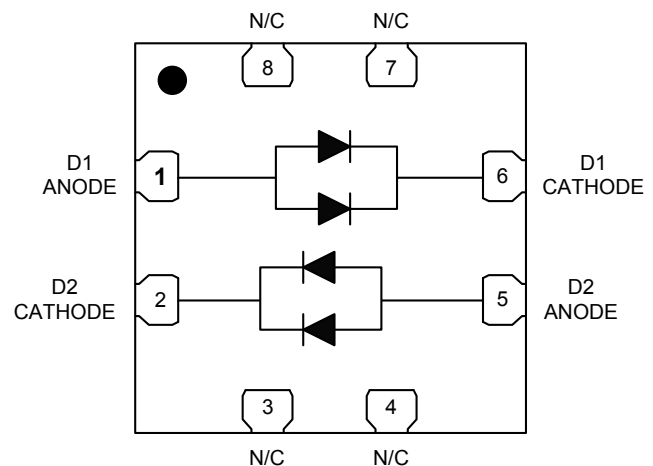

Pin Configuration³

Pin No.	Function
1	D1 Anode
2	D2 Cathode
3	No Connection
4	No Connection
5	D2 Anode
6	D1 Cathode
7	No Connection
8	No Connection
Paddle ⁴	Ground

3. MACOM recommends connecting unused package pins to ground.
4. The exposed pad centered on the package bottom must be connected to RF, DC and thermal ground.

* Restrictions on Hazardous Substances, European Union Directive 2011/65/EU.

Dual Pair Anti-Parallel Non-Magnetic PIN
5 - 400 MHz

Rev. V1

Electrical Specifications⁵: $T_A = 25^\circ\text{C}$, $Z_0 = 50 \Omega$

Parameter	Test Conditions	Units	Min.	Typ.	Max.
Total Capacitance (C_T)	100 MHz, 0 V	pF	—	3.0	4.0
Series Resistance (R_S)	100 MHz, +10 mA	Ω	—	0.5	—
Parallel Resistance (R_P)	100 MHz, 0 V	k Ω	—	10	—
Reverse Breakdown Voltage	-10 μA	V	—	100	—
Forward Voltage	+10 mA	V	—	0.85	—
Carrier Lifetime	1 kHz, +10 mA, -6 mA	μs	—	0.2	—
CW Thermal Resistance (Θ_{JC})	(Infinite heat sink at thermal ground plane)	$^\circ\text{C}/\text{W}$	—	22	—
Insertion Loss	100 MHz, +10 mA	dB	—	0.05	—
Input/output Return Loss	100 MHz, +10 mA	dB	—	30	—
Isolation	100 MHz, 0 V	dB	—	14	—

5. Per diode pair D1 or D2

Absolute Maximum Ratings^{6,7}

Parameter	Absolute Maximum
CW Incident Power +50 mA, 400 MHz @ 85 $^\circ\text{C}$	+51 dBm
Reverse Voltage	80 V
AC _{RMS} + DC Forward Current (per diode pair D1 or D2)	3.7 A
Power Dissipation (per diode pair D1 or D2)	4.7 W
Junction Temperature ⁸	+175 $^\circ\text{C}$
Operating Temperature	-55 $^\circ\text{C}$ to +125 $^\circ\text{C}$
Storage Temperature	-55 $^\circ\text{C}$ to +125 $^\circ\text{C}$

6. Exceeding any one or combination of these limits may cause permanent damage to this device.
7. MACOM does not recommend sustained operation near these survivability limits.
8. Operating at nominal conditions with $T_J \leq +175^\circ\text{C}$ will ensure MTTF > 1×10^6 hours.

Handling Procedures

Please observe the following precautions to avoid damage:

Static Sensitivity

These devices are sensitive to electrostatic discharge (ESD) and can be damaged by static electricity. Proper ESD control techniques should be used when handling these class 2 devices.

Dual Pair Anti-Parallel Non-Magnetic PIN 5 - 400 MHz

Rev. V1

Low Power Sample Board (< +20 dBm⁹)

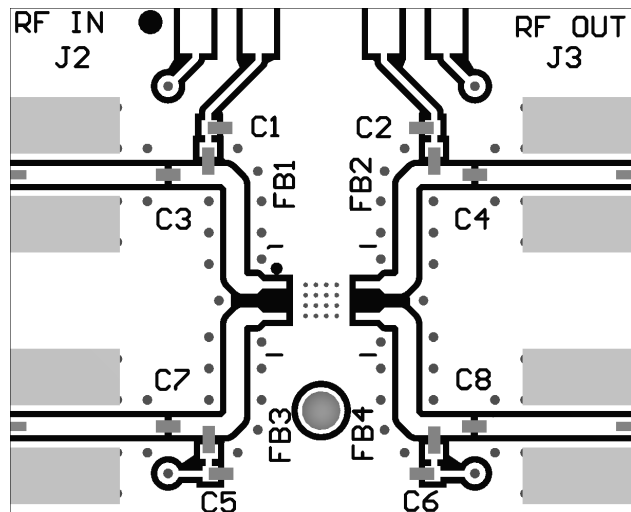

9. The board is recommended for small signal. For high power operation, heat sink is required.

Parts List: 100 - 400 MHz

Part	Value	Case Style
C1,C2,C5,C6	100 pF	0402
C3, C4, C7, C8	1 μ F ¹⁰	0402
Ferrite Bead: FB1,FB2,FB3,FB4	1000 Ω AC Resistance @ 1 GHz ¹¹	0402

10. These values are recommended for 100 - 400 MHz operation. Increase capacitance to 10 μ F for operation below 100 MHz.
11. Recommended part: Murata BLM15HD102SN1

Application Schematic

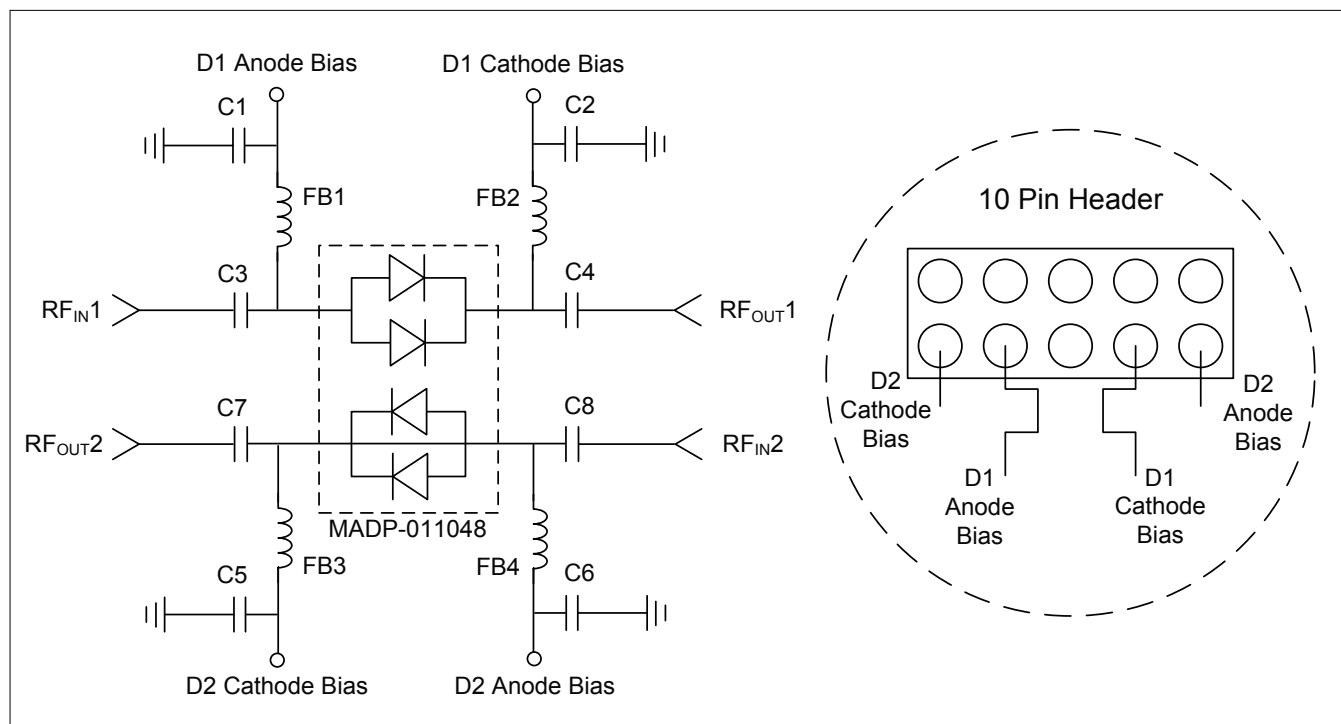

Typical Performance Curves¹²

Insertion Loss, 10 mA Forward Bias

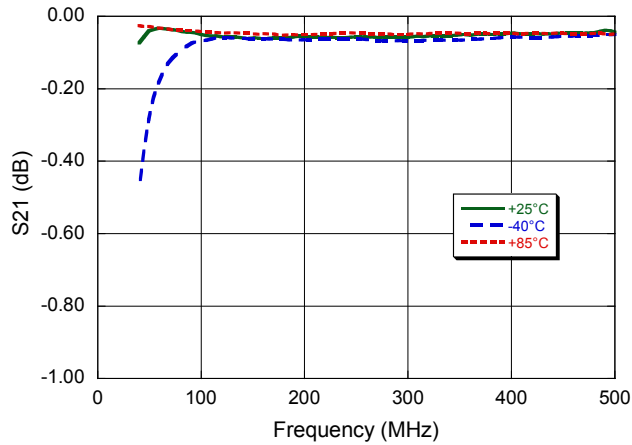

Insertion Loss, 20 mA Forward Bias

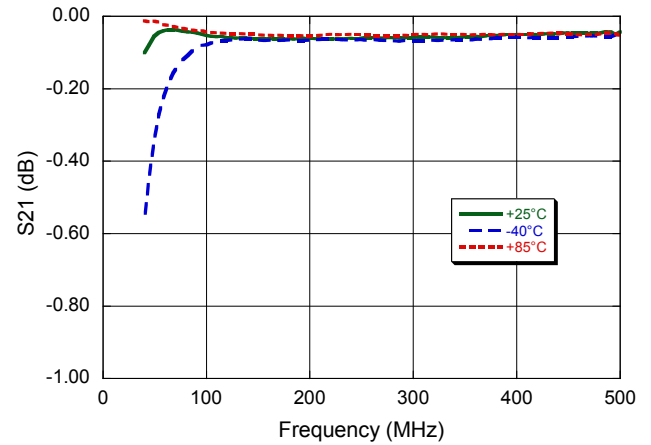

Insertion Loss, 50 mA Forward Bias

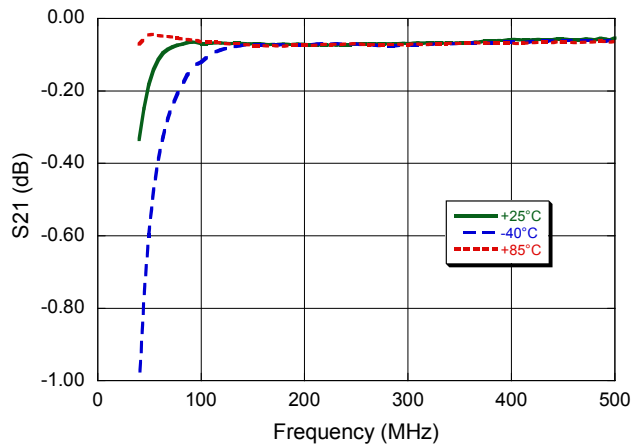

Insertion Loss, 100 mA Forward Bias

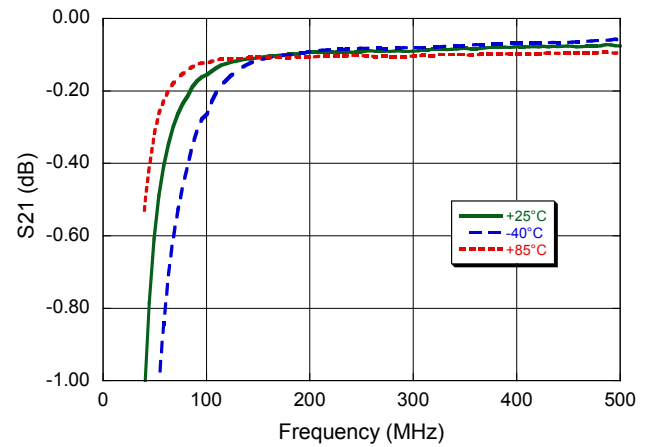

12. Performance below 100 MHz is limited by sample board bias components.

Typical Performance Curves¹³

Return Loss, 10 mA Forward Bias

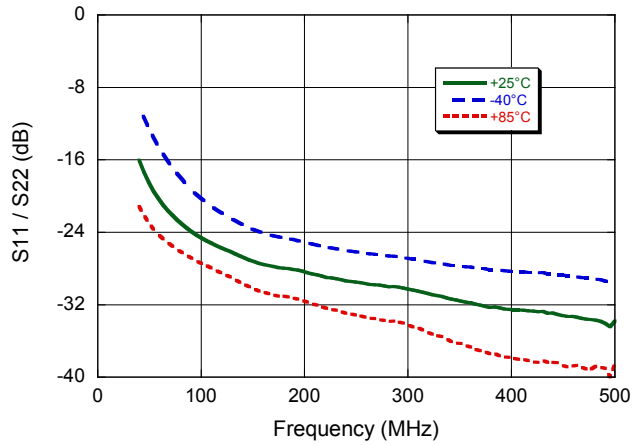

Return Loss, 20 mA Forward Bias

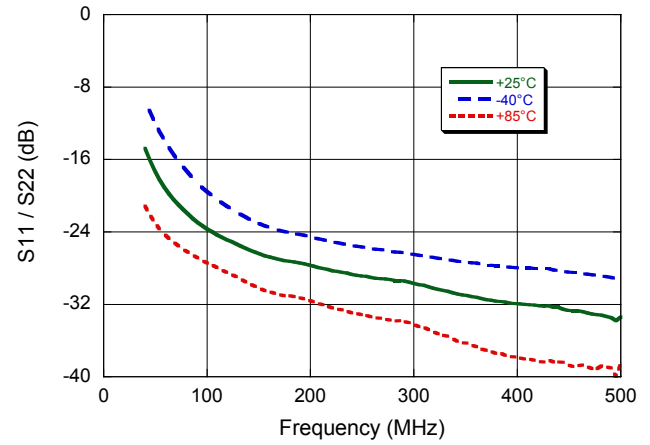

Return Loss, 50 mA Forward Bias

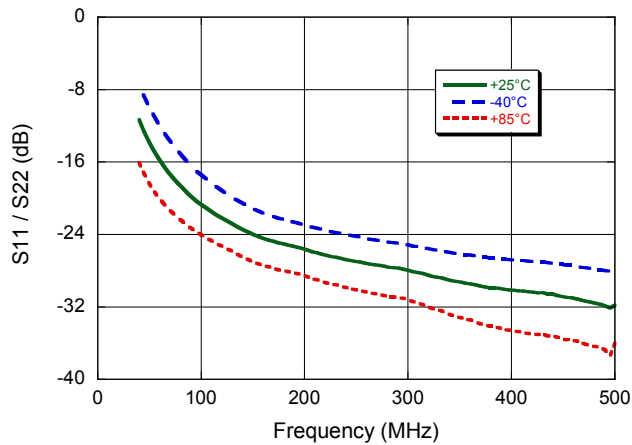

Return Loss, 100 mA Forward Bias

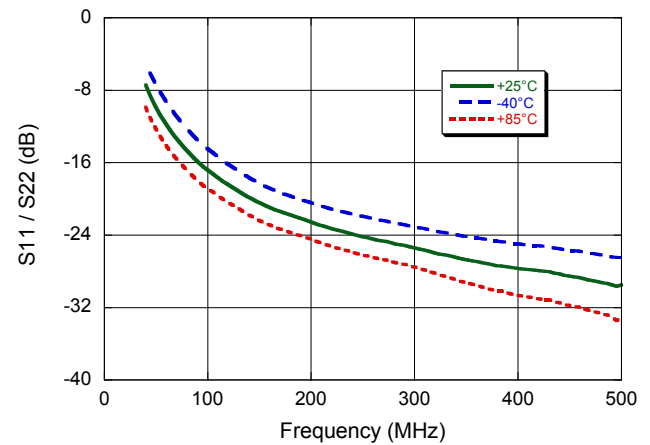

13. Performance below 100 MHz is limited by sample board bias components.

Typical Performance Curves¹⁴

Isolation, 0 V Reverse Bias

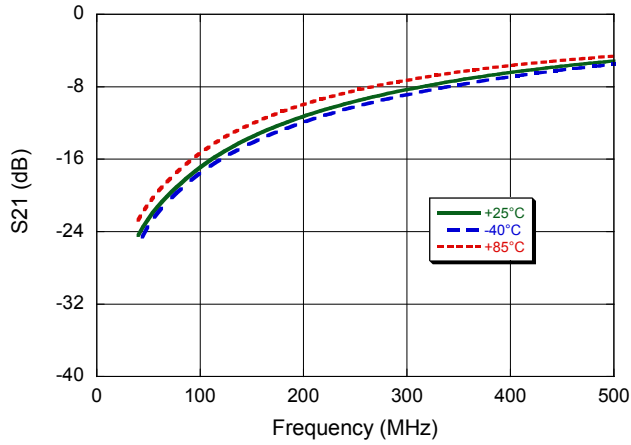

Isolation, 10 V Reverse Bias

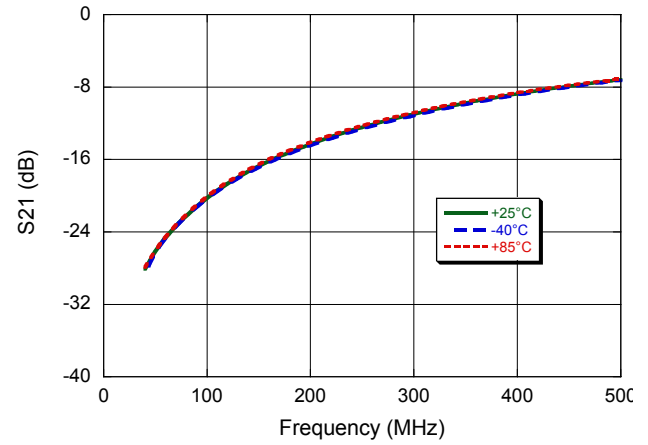

Isolation, 40 V Reverse Bias

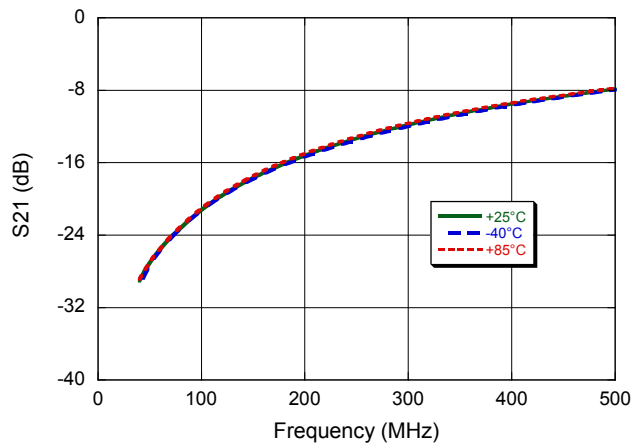

Output Power vs. Incident Power @ 400 MHz CW

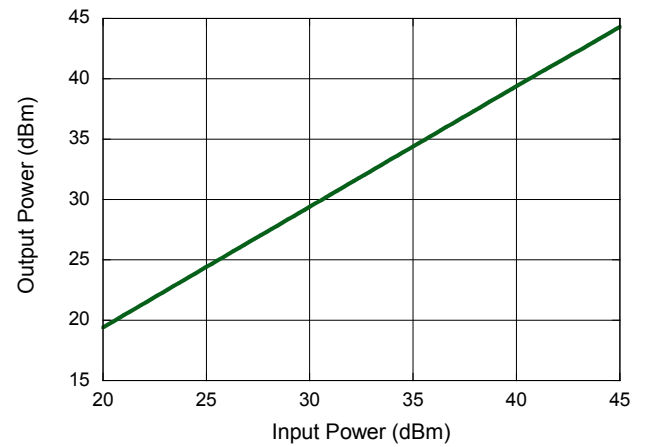

14. Performance below 100 MHz is limited by sample board bias components.

Lead-Free 4 mm 8-Lead HQFN[†]

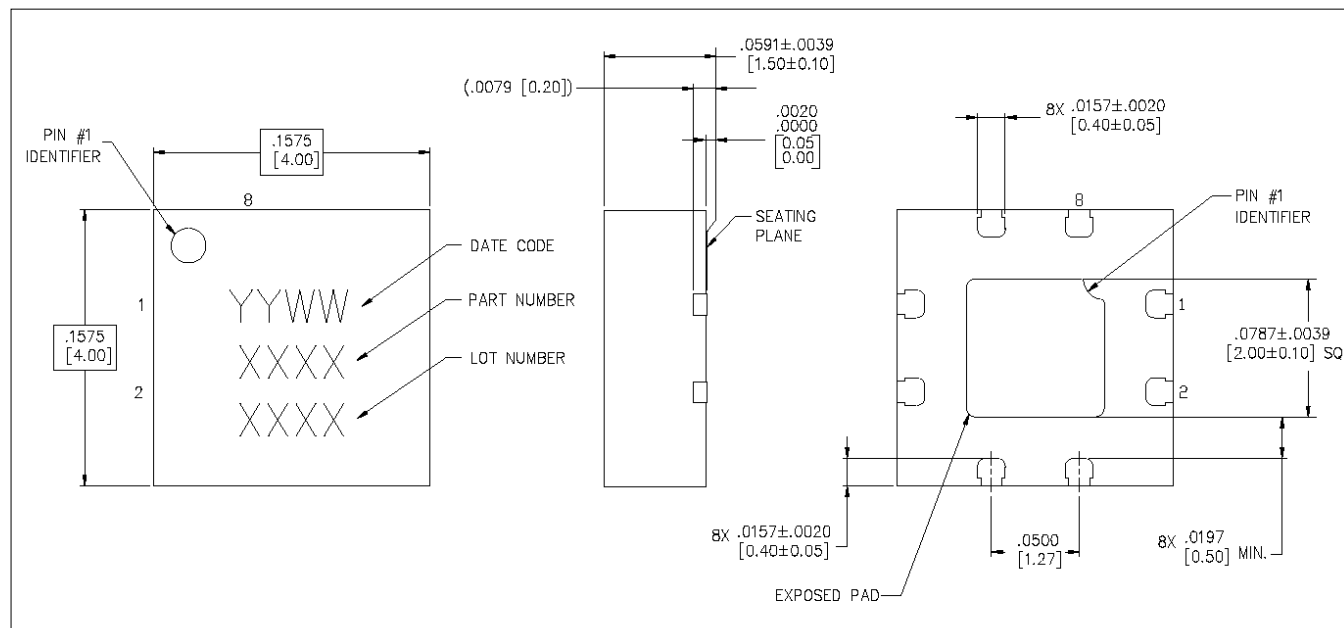

[†] Reference Application Note S2083 for lead-free solder reflow recommendations.
 Meets JEDEC moisture sensitivity level 1 requirements.
 Plating is 100% matte tin over copper.



Стандарт Электрон Связь

Мы молодая и активно развивающаяся компания в области поставок электронных компонентов. Мы поставляем электронные компоненты отечественного и импортного производства напрямую от производителей и с крупнейших складов мира.

Благодаря сотрудничеству с мировыми поставщиками мы осуществляем комплексные и плановые поставки широчайшего спектра электронных компонентов.

Собственная эффективная логистика и склад в обеспечивает надежную поставку продукции в точно указанные сроки по всей России.

Мы осуществляем техническую поддержку нашим клиентам и предпродажную проверку качества продукции. На все поставляемые продукты мы предоставляем гарантию .

Осуществляем поставки продукции под контролем ВП МО РФ на предприятия военно-промышленного комплекса России , а также работаем в рамках 275 ФЗ с открытием отдельных счетов в уполномоченном банке. Система менеджмента качества компании соответствует требованиям ГОСТ ISO 9001.

Минимальные сроки поставки, гибкие цены, неограниченный ассортимент и индивидуальный подход к клиентам являются основой для выстраивания долгосрочного и эффективного сотрудничества с предприятиями радиоэлектронной промышленности, предприятиями ВПК и научно-исследовательскими институтами России.

С нами вы становитесь еще успешнее!

Наши контакты:

Телефон: +7 812 627 14 35

Электронная почта: sales@st-electron.ru

Адрес: 198099, Санкт-Петербург,
Промышленная ул, дом № 19, литера Н,
помещение 100-Н Офис 331