

PNP Silicon AF Transistor

- For AF input stages and driver applications
- High current gain
- Low collector-emitter saturation voltage
- Low noise between 30 hz and 15 kHz
- Complementary types:
BC847...-BC850... (NPN)
- Pb-free (RoHS compliant) package
- Qualified according AEC Q101¹⁾



¹BC857BL3 is not qualified according AEC Q101

| Type | Marking | Pin Configuration | | | | | | Package |
|-----------|---------|-------------------|-----|-----|---|---|---|----------|
| | | 1=B | 2=E | 3=C | - | - | - | |
| BC857A | 3Es | 1=B | 2=E | 3=C | - | - | - | SOT23 |
| BC857B | 3Fs | 1=B | 2=E | 3=C | - | - | - | SOT23 |
| BC857BL3* | 3F | 1=B | 2=E | 3=C | - | - | - | TSLP-3-1 |
| BC857BW | 3Fs | 1=B | 2=E | 3=C | - | - | - | SOT323 |
| BC857C | 3Gs | 1=B | 2=E | 3=C | - | - | - | SOT23 |
| BC857CW | 3Gs | 1=B | 2=E | 3=C | - | - | - | SOT323 |
| BC858A | 3Js | 1=B | 2=E | 3=C | - | - | - | SOT23 |
| BC858B | 3Ks | 1=B | 2=E | 3=C | - | - | - | SOT23 |
| BC858BW | 3Ks | 1=B | 2=E | 3=C | - | - | - | SOT323 |
| BC858C | 3Ls | 1=B | 2=E | 3=C | - | - | - | SOT23 |
| BC858CW | 3Ls | 1=B | 2=E | 3=C | - | - | - | SOT323 |
| BC859C | 4Cs | 1=B | 2=E | 3=C | - | - | - | SOT23 |
| BC860B | 4Fs | 1=B | 2=E | 3=C | - | - | - | SOT23 |
| BC860BW | 4Fs | 1=B | 2=E | 3=C | - | - | - | SOT323 |
| BC860CW | 4Gs | 1=B | 2=E | 3=C | - | - | - | SOT323 |

* Not qualified according AEC Q101

Maximum Ratings

| Parameter | Symbol | Value | Unit |
|---|-----------|-------------------|------|
| Collector-emitter voltage BC857..., BC860... BC858..., BC859... | V_{CEO} | 45 30 | V |
| Collector-base voltage BC857..., BC860... BC858..., BC859... | V_{CBO} | 50 30 | |
| Emitter-base voltage | V_{EBO} | 5 | |
| Collector current | I_C | 100 | mA |
| Peak collector current, $t_p \leq 10$ ms | I_{CM} | 200 | |
| Total power dissipation $T_S \leq 71$ °C, BC857-BC860 $T_S \leq 135$ °C, BC857BL3 $T_S \leq 124$ °C, BC857W-BC860W | P_{tot} | 330 250 250 | mW |
| Junction temperature | T_j | 150 | °C |
| Storage temperature | T_{stg} | -65 ... 150 | |

Thermal Resistance

| Parameter | Symbol | Value | Unit |
|--|------------|---------------------------------------|------|
| Junction - soldering point ¹⁾ BC857-BC860 BC857BL3 BC857W-BC860W | R_{thJS} | ≤ 240 ≤ 60 ≤ 105 | K/W |

¹⁾For calculation of R_{thJA} please refer to Application Note AN077 (Thermal Resistance Calculation)

Electrical Characteristics at $T_A = 25^\circ\text{C}$, unless otherwise specified

| Parameter | Symbol | Values | | | Unit |
|---|---------------|----------------------------------|--|----------------------------------|---------------|
| | | min. | typ. | max. | |
| DC Characteristics | | | | | |
| Collector-emitter breakdown voltage $I_C = 10\text{ mA}$, $I_B = 0$, BC857..., BC860... $I_C = 10\text{ mA}$, $I_B = 0$, BC858..., BC859... | $V_{(BR)CEO}$ | 45 30 | - - | - - | V |
| Collector-base breakdown voltage $I_C = 10\text{ }\mu\text{A}$, $I_E = 0$, BC857..., BC860... $I_C = 10\text{ }\mu\text{A}$, $I_E = 0$, BC858..., BC859... | $V_{(BR)CBO}$ | 50 30 | - - | - - | |
| Emitter-base breakdown voltage $I_E = 1\text{ }\mu\text{A}$, $I_C = 0$ | $V_{(BR)EBO}$ | 5 | - | - | |
| Collector-base cutoff current $V_{CB} = 45\text{ V}$, $I_E = 0$ $V_{CB} = 30\text{ V}$, $I_E = 0$, $T_A = 150\text{ }^\circ\text{C}$ | I_{CBO} | - - | - - | 0.015 5 | μA |
| DC current gain ¹⁾ $I_C = 10\text{ }\mu\text{A}$, $V_{CE} = 5\text{ V}$, $h_{FE}\text{-grp.A}$ $I_C = 10\text{ }\mu\text{A}$, $V_{CE} = 5\text{ V}$, $h_{FE}\text{-grp.B}$ $I_C = 10\text{ }\mu\text{A}$, $V_{CE} = 5\text{ V}$, $h_{FE}\text{-grp.C}$ $I_C = 2\text{ mA}$, $V_{CE} = 5\text{ V}$, $h_{FE}\text{-grp.A}$ $I_C = 2\text{ mA}$, $V_{CE} = 5\text{ V}$, $h_{FE}\text{-grp.B}$ $I_C = 2\text{ mA}$, $V_{CE} = 5\text{ V}$, $h_{FE}\text{-grp.C}$ | h_{FE} | - - - 125 220 420 | 140 250 480 180 290 520 | - - - 250 475 800 | - |
| Collector-emitter saturation voltage ¹⁾ $I_C = 10\text{ mA}$, $I_B = 0.5\text{ mA}$ $I_C = 100\text{ mA}$, $I_B = 5\text{ mA}$ | V_{CEsat} | - - | 75 250 | 300 650 | mV |
| Base emitter saturation voltage ¹⁾ $I_C = 10\text{ mA}$, $I_B = 0.5\text{ mA}$ $I_C = 100\text{ mA}$, $I_B = 5\text{ mA}$ | V_{BEsat} | - - | 700 850 | - - | |
| Base-emitter voltage ¹⁾ $I_C = 2\text{ mA}$, $V_{CE} = 5\text{ V}$ $I_C = 10\text{ mA}$, $V_{CE} = 5\text{ V}$ | $V_{BE(ON)}$ | 600 - | 650 - | 750 820 | |

¹⁾Pulse test: $t < 300\mu\text{s}$; $D < 2\%$

Electrical Characteristics at $T_A = 25^\circ\text{C}$, unless otherwise specified

| Parameter | Symbol | Values | | | Unit | |
|---|-----------|--------|-------------------|------|---------------|------------------|
| | | min. | typ. | max. | | |
| AC Characteristics | | | | | | |
| Transition frequency $I_C = 20\text{ mA}$, $V_{CE} = 5\text{ V}$, $f = 100\text{ MHz}$ | f_T | - | 250 | - | MHz | |
| Collector-base capacitance $V_{CB} = 10\text{ V}$, $f = 1\text{ MHz}$ | C_{cb} | - | 1.5 | - | pF | |
| Emitter-base capacitance $V_{EB} = 0.5\text{ V}$, $f = 1\text{ MHz}$ | C_{eb} | - | 8 | - | | |
| Short-circuit input impedance $I_C = 2\text{ mA}$, $V_{CE} = 5\text{ V}$, $f = 1\text{ kHz}$, $h_{FE}\text{-grp.A}$ $I_C = 2\text{ mA}$, $V_{CE} = 5\text{ V}$, $f = 1\text{ kHz}$, $h_{FE}\text{-grp.B}$ $I_C = 2\text{ mA}$, $V_{CE} = 5\text{ V}$, $f = 1\text{ kHz}$, $h_{FE}\text{-grp.C}$ | h_{11e} | - | 2.7 4.5 8.7 | - | k Ω | |
| Open-circuit reverse voltage transf. ratio $I_C = 2\text{ mA}$, $V_{CE} = 5\text{ V}$, $f = 1\text{ kHz}$, $h_{FE}\text{-grp.A}$ $I_C = 2\text{ mA}$, $V_{CE} = 5\text{ V}$, $f = 1\text{ kHz}$, $h_{FE}\text{-grp.B}$ $I_C = 2\text{ mA}$, $V_{CE} = 5\text{ V}$, $f = 1\text{ kHz}$, $h_{FE}\text{-grp.C}$ | h_{12e} | - | 1.5 2 3 | - | | 10 ⁻⁴ |
| Short-circuit forward current transf. ratio $I_C = 2\text{ mA}$, $V_{CE} = 5\text{ V}$, $f = 1\text{ kHz}$, $h_{FE}\text{-grp.A}$ $I_C = 2\text{ mA}$, $V_{CE} = 5\text{ V}$, $f = 1\text{ kHz}$, $h_{FE}\text{-grp.B}$ $I_C = 2\text{ mA}$, $V_{CE} = 5\text{ V}$, $f = 1\text{ kHz}$, $h_{FE}\text{-grp.C}$ | h_{21e} | - | 200 330 600 | - | | |
| Open-circuit output admittance $I_C = 2\text{ mA}$, $V_{CE} = 5\text{ V}$, $f = 1\text{ kHz}$, $h_{FE}\text{-grp.A}$ $I_C = 2\text{ mA}$, $V_{CE} = 5\text{ V}$, $f = 1\text{ kHz}$, $h_{FE}\text{-grp.B}$ $I_C = 2\text{ mA}$, $V_{CE} = 5\text{ V}$, $f = 1\text{ kHz}$, $h_{FE}\text{-grp.C}$ | h_{22e} | - | 18 30 60 | - | μS | |
| Noise figure $I_C = 0.2\text{ mA}$, $V_{CE} = 5\text{ V}$, $f = 1\text{ kHz}$, $\Delta f = 200\text{ Hz}$, $R_S = 2\text{ k}\Omega$, BC859, BC850 | F | - | 1 | 4 | | dB |
| Equivalent noise voltage $I_C = 200\text{ mA}$, $V_{CE} = 5\text{ V}$, $R_S = 2\text{ k}\Omega$, $f = 10\text{...}50\text{ Hz}$, BC860 | V_n | - | - | 0.11 | | |

DC current gain $h_{FE} = f(I_C)$

$V_{CE} = 1\text{ V}$

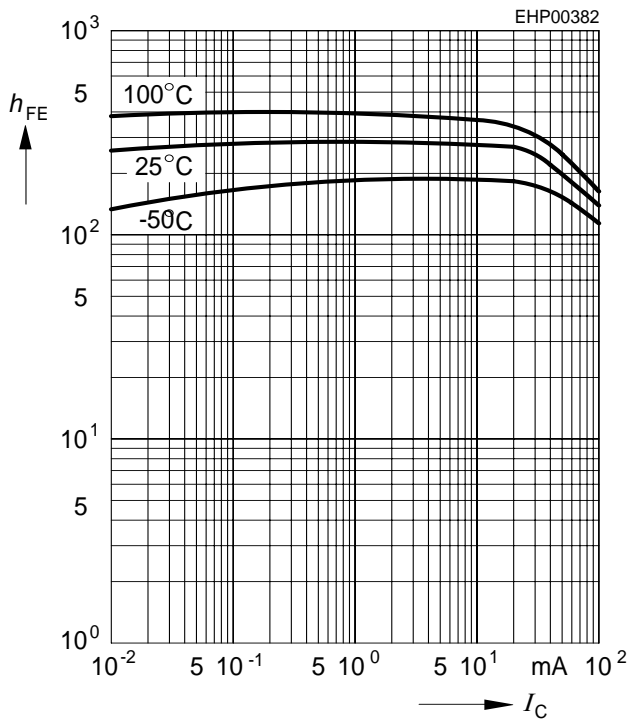

Collector-emitter saturation voltage

$I_C = f(V_{CEsat}), h_{FE} = 20$

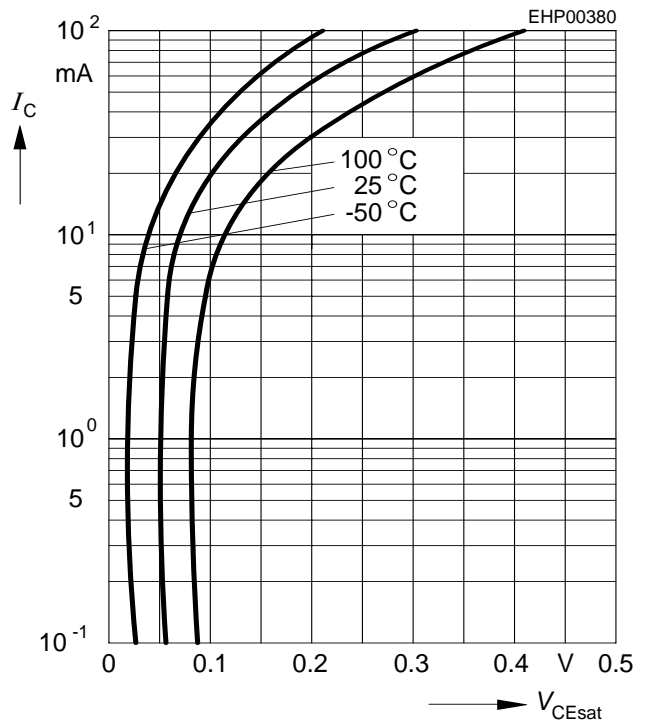

Base-emitter saturation voltage

$I_C = f(V_{BEsat}), h_{FE} = 20$

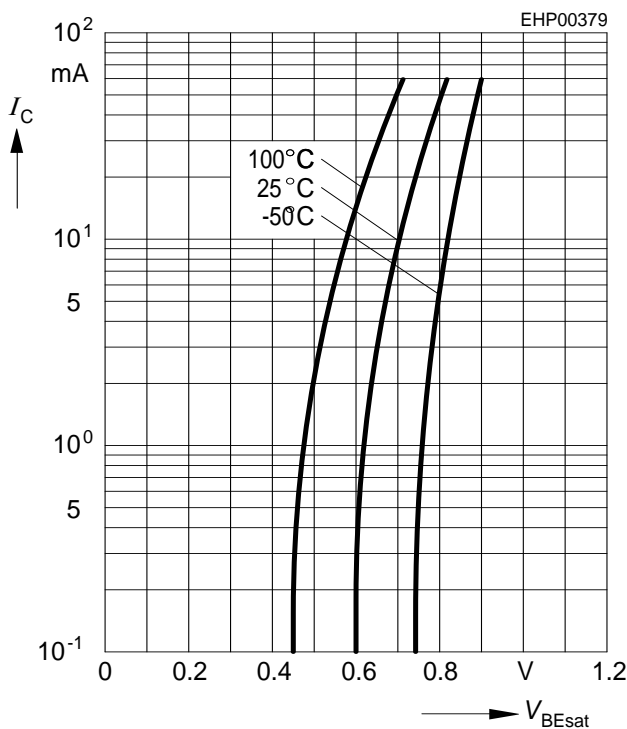

Collector cutoff current $I_{CBO} = f(T_A)$

$V_{CBO} = 30\text{ V}$

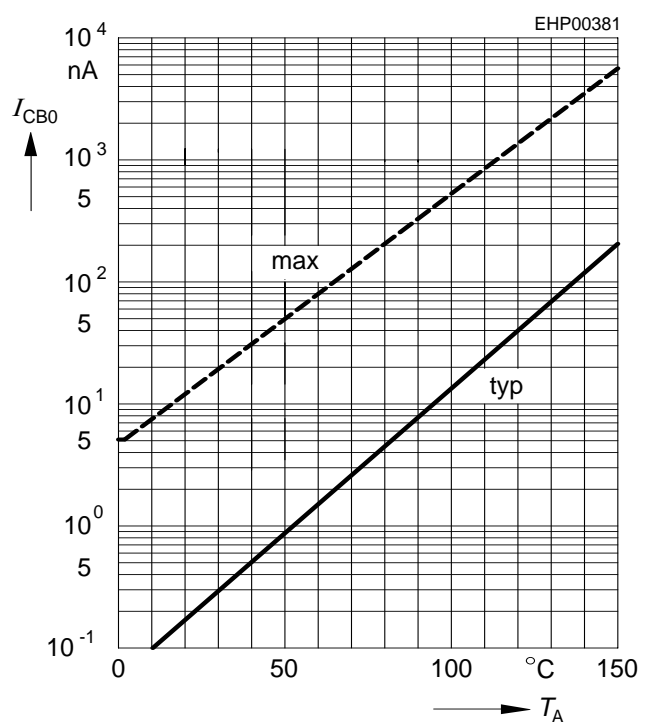

Transition frequency $f_T = f(I_C)$

$V_{CE} = 5\text{ V}$



Collector-base capacitance $C_{cb} = f(V_{CB})$

Emitter-base capacitance $C_{eb} = f(V_{EB})$



Total power dissipation $P_{tot} = f(T_S)$

BC856-BC860



Total power dissipation $P_{tot} = f(T_S)$

BC857BL3



Total power dissipation $P_{tot} = f(T_S)$

BC857W-BC860W



Permissible Pulse Load

$P_{totmax}/P_{totDC} = f(t_p)$

BC857/W-BC860/W



Permissible Puls Load $R_{thJS} = f(t_p)$

BC857BL3



Permissible Pulse Load

$P_{totmax}/P_{totDC} = f(t_p)$

BC857BL3



Package Outline



1) Lead width can be 0.6 max. in dambar area

Foot Print



Marking Layout (Example)



Standard Packing

Reel \varnothing 180 mm = 3.000 Pieces/Reel
 Reel \varnothing 330 mm = 10.000 Pieces/Reel



Package Outline



Foot Print



Marking Layout (Example)



Standard Packing

Reel \varnothing 180 mm = 3.000 Pieces/Reel
 Reel \varnothing 330 mm = 10.000 Pieces/Reel



Package Outline

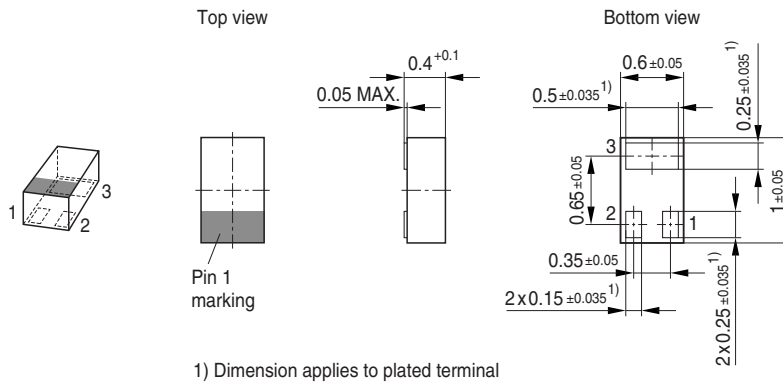

Foot Print

For board assembly information please refer to Infineon website "Packages"

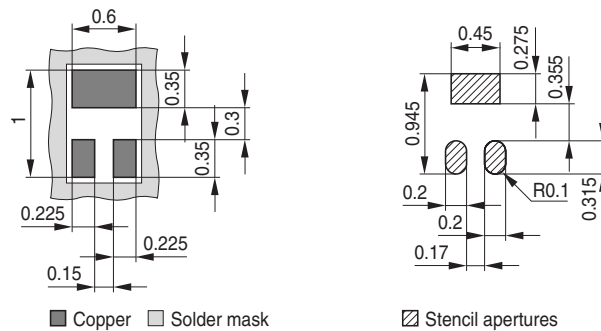

Marking Layout (Example)

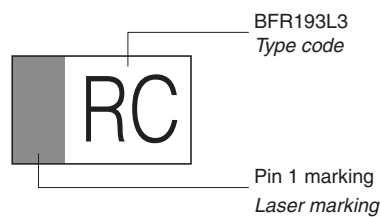

Standard Packing

Reel ø180 mm = 15.000 Pieces/Reel

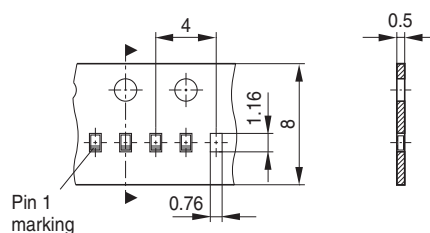

Edition 2009-11-16

**Published by
Infineon Technologies AG
81726 Munich, Germany**

**© 2009 Infineon Technologies AG
All Rights Reserved.**

Legal Disclaimer

The information given in this document shall in no event be regarded as a guarantee of conditions or characteristics. With respect to any examples or hints given herein, any typical values stated herein and/or any information regarding the application of the device, Infineon Technologies hereby disclaims any and all warranties and liabilities of any kind, including without limitation, warranties of non-infringement of intellectual property rights of any third party.

Information

For further information on technology, delivery terms and conditions and prices, please contact the nearest Infineon Technologies Office (www.infineon.com).

Warnings

Due to technical requirements, components may contain dangerous substances. For information on the types in question, please contact the nearest Infineon Technologies Office.

Infineon Technologies components may be used in life-support devices or systems only with the express written approval of Infineon Technologies, if a failure of such components can reasonably be expected to cause the failure of that life-support device or system or to affect the safety or effectiveness of that device or system. Life support devices or systems are intended to be implanted in the human body or to support and/or maintain and sustain and/or protect human life. If they fail, it is reasonable to assume that the health of the user or other persons may be endangered.



Стандарт Электрон Связь

Мы молодая и активно развивающаяся компания в области поставок электронных компонентов. Мы поставляем электронные компоненты отечественного и импортного производства напрямую от производителей и с крупнейших складов мира.

Благодаря сотрудничеству с мировыми поставщиками мы осуществляем комплексные и плановые поставки широчайшего спектра электронных компонентов.

Собственная эффективная логистика и склад в обеспечивает надежную поставку продукции в точно указанные сроки по всей России.

Мы осуществляем техническую поддержку нашим клиентам и предпродажную проверку качества продукции. На все поставляемые продукты мы предоставляем гарантию .

Осуществляем поставки продукции под контролем ВП МО РФ на предприятия военно-промышленного комплекса России , а также работаем в рамках 275 ФЗ с открытием отдельных счетов в уполномоченном банке. Система менеджмента качества компании соответствует требованиям ГОСТ ISO 9001.

Минимальные сроки поставки, гибкие цены, неограниченный ассортимент и индивидуальный подход к клиентам являются основой для выстраивания долгосрочного и эффективного сотрудничества с предприятиями радиоэлектронной промышленности, предприятиями ВПК и научно-исследовательскими институтами России.

С нами вы становитесь еще успешнее!

Наши контакты:

Телефон: +7 812 627 14 35

Электронная почта: sales@st-electron.ru

Адрес: 198099, Санкт-Петербург,
Промышленная ул, дом № 19, литера Н,
помещение 100-Н Офис 331