

RTEN SERIES

Multipurpose Three-Phase Filter with Many Current Variations



FEATURES

- 6 to 300A wide range lineup.
- Small due to L1, light and thin.
- Low-profile design.
- Self-tightening screws and an open/close type cover make wiring work easier.
- Terminal block cover included for safety.
- DIN rail installation compatible type is also available.
- Compliant with RoHS directives.

SAFETY STANDARDS

UL1283	File No. E62388 (Up to 150A)
EN60939	Licence Ref. No. SE/07115-5 (Up to 60A)
	SE/07115-4 (80A to)

PRODUCT IDENTIFICATION

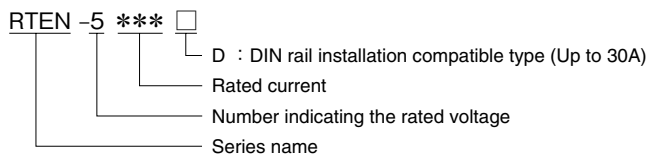

CIRCUIT DIAGRAM

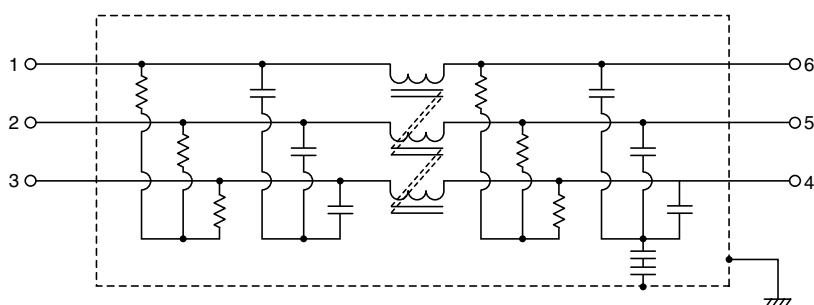

• Conformity to RoHS Directive: This means that, in conformity with EU Directive 2002/95/EC, lead, cadmium, mercury, hexavalent chromium, and specific bromine-based flame retardants, PBB and PBDE, have not been used, except for exempted applications.

• All specifications are subject to change without notice.

ELECTRICAL CHARACTERISTICS

Part No.	Rated voltage (AC/DC)	Rated current (AC/DC)	Withstand voltage	Insulation resistance	Leakage current	Operating temperature range	With derating over	DC resistance (mΩ)	Attenuation frequency range (MHz)	
									Common mode	Differential mode
									at 25dB	at 25dB
RTEN-5006	500V	6A	AC.2500V 60s [Between line to ground]	100MΩ min. [DC.500V/ 1min.]	2.5mA max. [250V/60Hz] 5mA max. [500V/60Hz]	-25 to +85°C	50°C	145 max.	0.2 to 10	0.2 to 30
RTEN-5010		10A						60 max.	0.2 to 10	0.2 to 30
RTEN-5020		20A						25 max.	0.3 to 8	0.2 to 30
RTEN-5030		30A						13 max.	0.5 to 8	0.2 to 30
RTEN-5040		40A						10 max.	0.3 to 7	0.2 to 30
RTEN-5050		50A						7 max.	0.5 to 7	0.2 to 30
RTEN-5060		60A						5 max.	0.7 to 5	0.2 to 30
RTEN-5080		80A						5 max.	0.3 to 7	0.2 to 30
RTEN-5100		100A						4 max.	0.3 to 7	0.2 to 30
RTEN-5150		150A						3 max.	0.3 to 7	0.2 to 20
RTEN-5200		200A						2 max.	0.5 to 10	0.2 to 20
RTEN-5250		250A						1.5 max.	1 to 6	0.2 to 20
RTEN-5300		300A						1 max.	1.5 to 5	0.2 to 20

DERATINGS

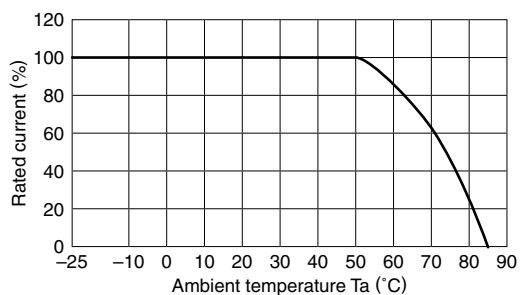

■ SHAPES AND DIMENSIONS

RTEN-5006/5010

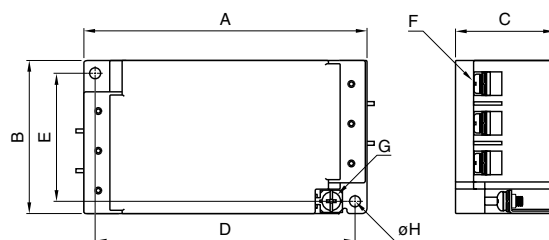

RTEN-5020/5030/5040/5050/5060

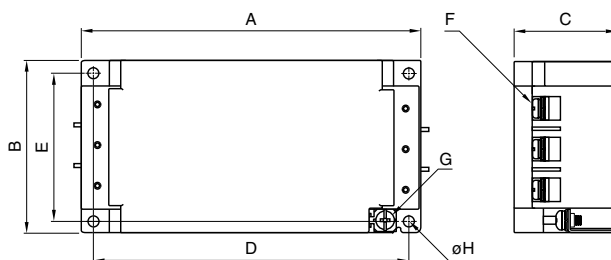

RTEN-5080/5100/5150/5200/5250/5300

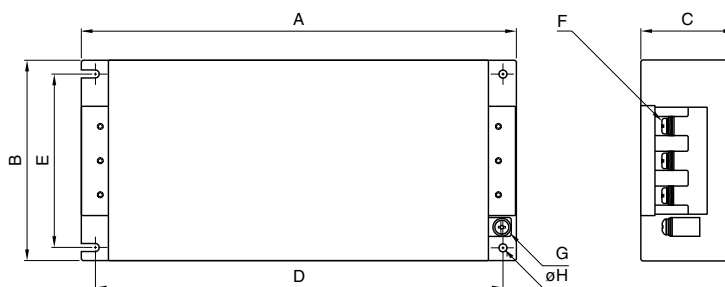

Dimensions in mm

Part No.	A	B	C	D	E	F	G	φH	Recommended clamping torque
RTEN-5006	120	63	42	110	53	M4	M4	4.5	M4 : 1.27N · m M5 : 2.5N · m M6 : 4.8N · m M8 : 7.64N · m M10 : 11.8N · m
RTEN-5010									
RTEN-5020	140	70	42	130	60	M4	M4		
RTEN-5030									
RTEN-5040	170	90	54	160	80	M5	M4	4.5	
RTEN-5050									
RTEN-5060									
RTEN-5080	267	161	85	247	135	M8	M6	6.5	
RTEN-5100									
RTEN-5150	290	190	88	270	164	M8	M6	6.5	
RTEN-5200									
RTEN-5250	390	195	103	370	169	M10	M8	6.5	
RTEN-5300									

RTEN-5006D/5010D

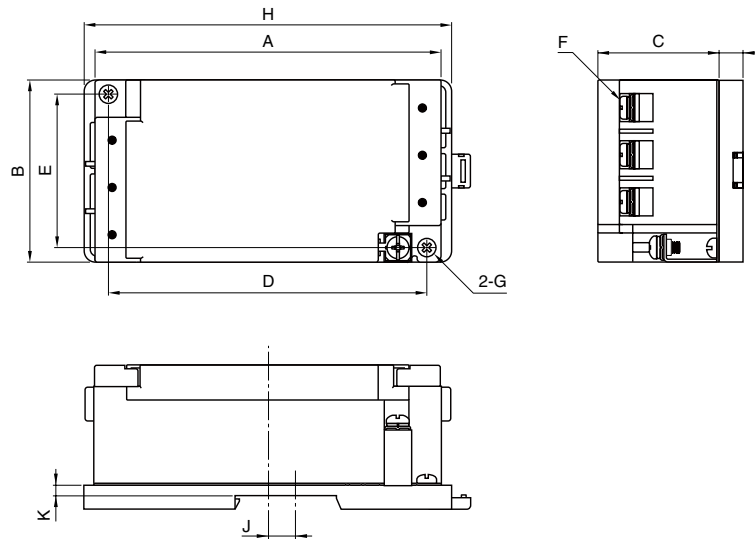

RTEN-5020D/5030D

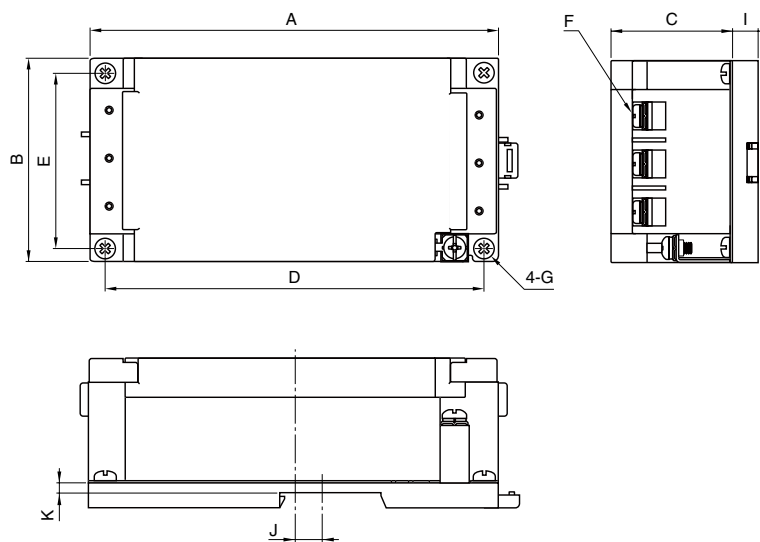

Dimensions in mm

Part No.	A	B	C	D	E	F	G	H	I	J	K
RTEN-5006D	120	63	42	110	53	M4	M4	127	8.4	6	3.5
RTEN-5010D								-	8.4	12.5	3.5
RTEN-5020D	140	70	42	130	60	M4	M4	-	8.4	12.5	3.5
RTEN-5030D								-	8.4	12.5	3.5

■ ATTENUATION vs. FREQUENCY CHARACTERISTICS

RTEN-5006

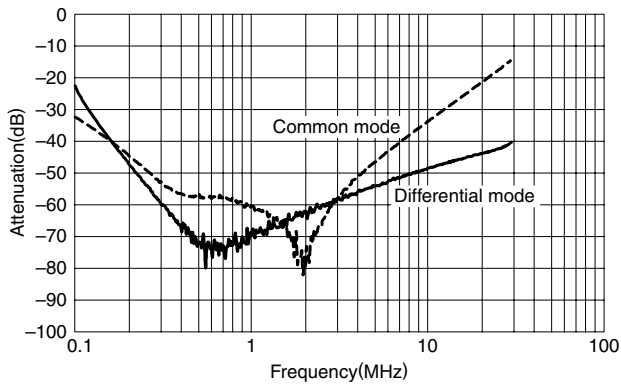

RTEN-5010

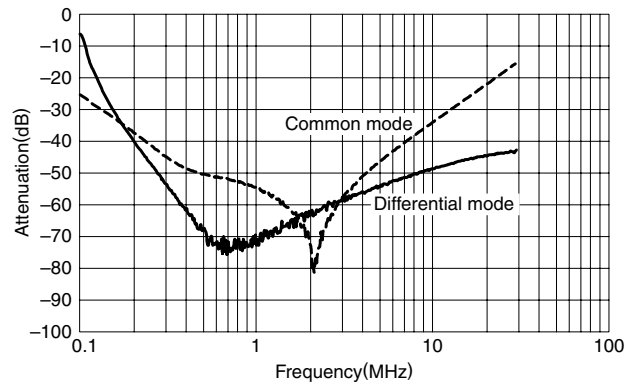

RTEN-5020

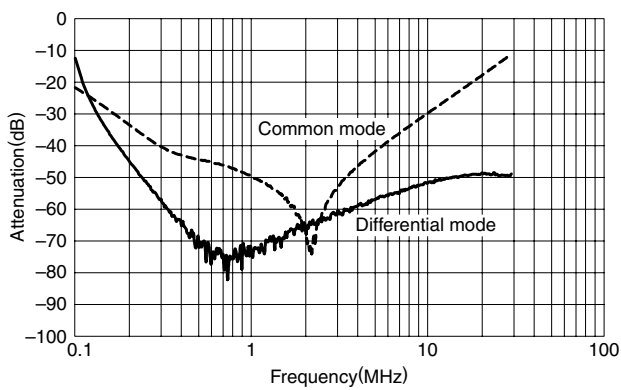

RTEN-5030

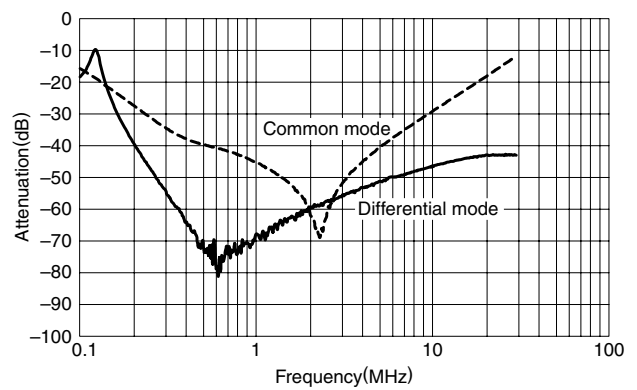

RTEN-5040

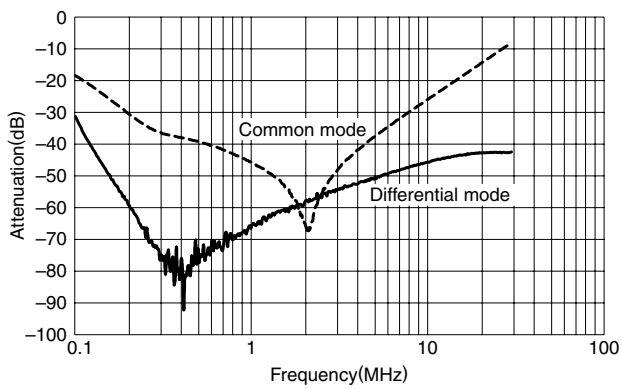

RTEN-5050

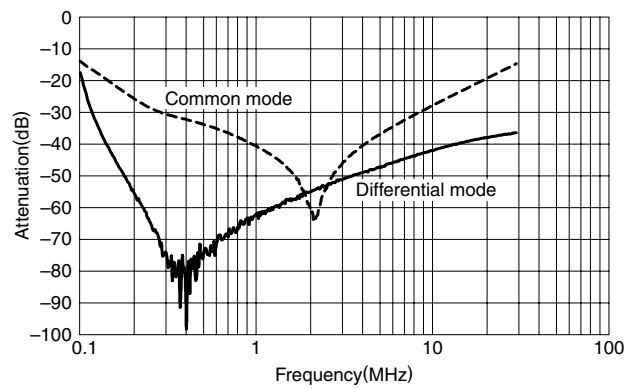

RTEN-5060

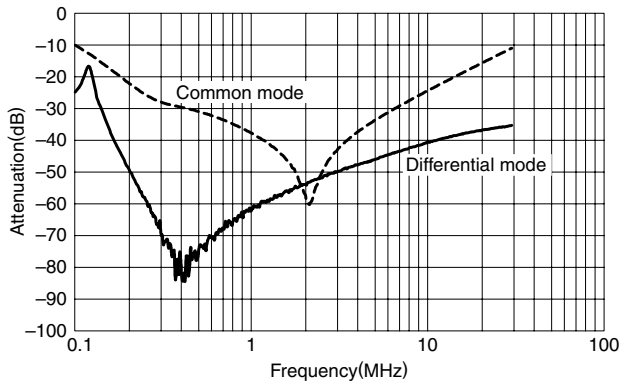

RTEN-5080

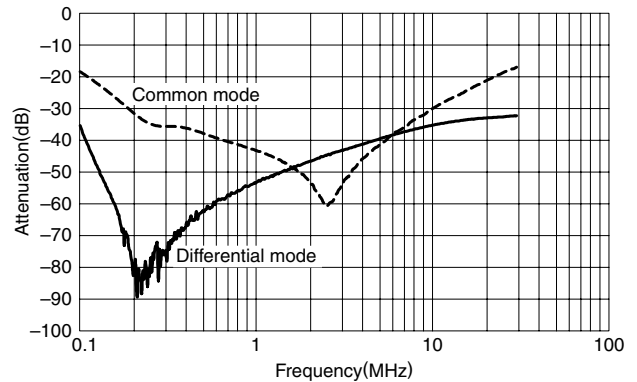

RTEN-5100

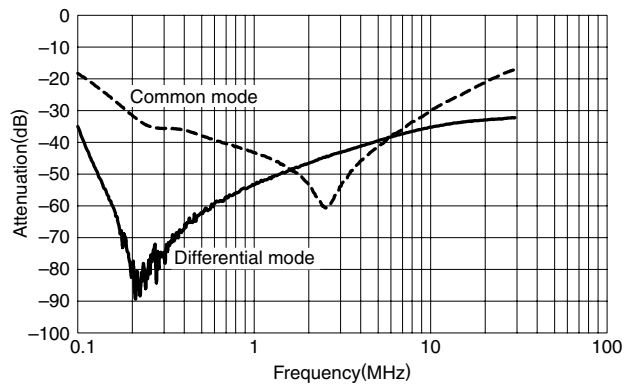

RTEN-5150

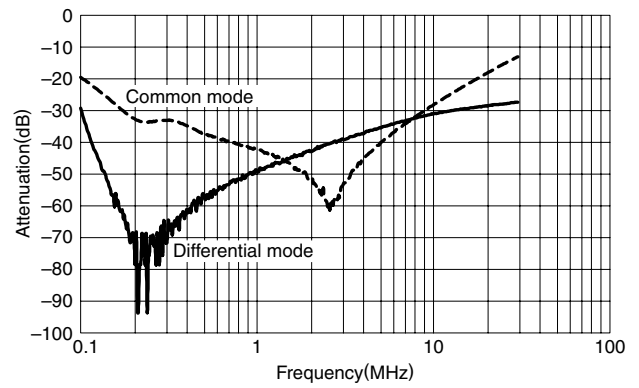

RTEN-5200

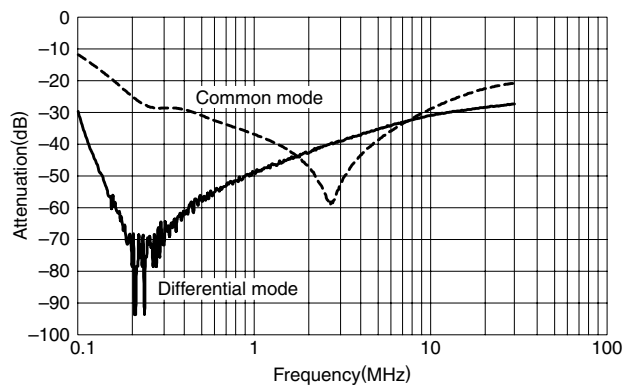

RTEN-5250

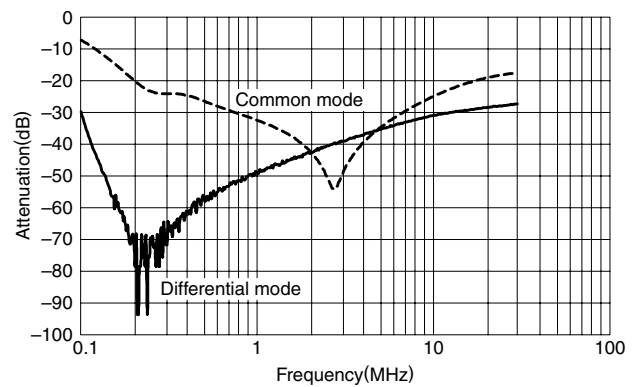

RTEN-5300

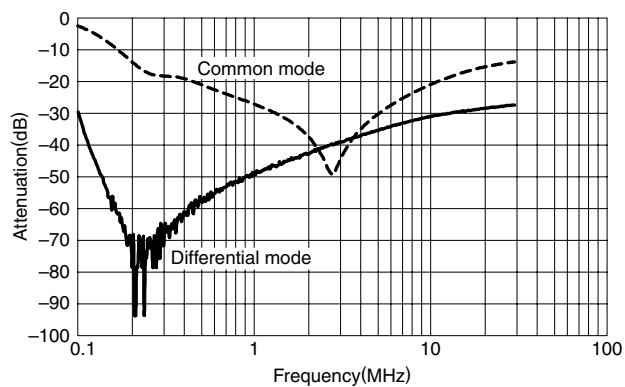



**Стандарт
Электрон
Связь**

Мы молодая и активно развивающаяся компания в области поставок электронных компонентов. Мы поставляем электронные компоненты отечественного и импортного производства напрямую от производителей и с крупнейших складов мира.

Благодаря сотрудничеству с мировыми поставщиками мы осуществляем комплексные и плановые поставки широчайшего спектра электронных компонентов.

Собственная эффективная логистика и склад в обеспечивает надежную поставку продукции в точно указанные сроки по всей России.

Мы осуществляем техническую поддержку нашим клиентам и предпродажную проверку качества продукции. На все поставляемые продукты мы предоставляем гарантию .

Осуществляем поставки продукции под контролем ВП МО РФ на предприятия военно-промышленного комплекса России , а также работаем в рамках 275 ФЗ с открытием отдельных счетов в уполномоченном банке. Система менеджмента качества компании соответствует требованиям ГОСТ ISO 9001.

Минимальные сроки поставки, гибкие цены, неограниченный ассортимент и индивидуальный подход к клиентам являются основой для выстраивания долгосрочного и эффективного сотрудничества с предприятиями радиоэлектронной промышленности, предприятиями ВПК и научно-исследовательскими институтами России.

С нами вы становитесь еще успешнее!

Наши контакты:

Телефон: +7 812 627 14 35

Электронная почта: sales@st-electron.ru

Адрес: 198099, Санкт-Петербург,
Промышленная ул, дом № 19, литера Н,
помещение 100-Н Офис 331