



Programmable Low-Jitter Precision LVDS Oscillator

General Description

The DSC8103 & DSC8123 series of high performance field-programmable oscillators utilizes a proven silicon MEMS technology to provide excellent jitter and stability over a wide range of supply voltages and temperatures. Using the TIMEFLASH programmer, the end user can easily program the oscillators' frequency in the field for immediate testing or use in advance prototype development or production.

DSC8103 has a standby feature allowing it to completely power-down when EN pin is pulled low; whereas for DSC8123, only the outputs are disabled when EN is low. Both oscillators are available in industry standard packages, including the small 3.2x2.5 mm², and are "drop-in" replacement for standard 6-pin LVDS quartz oscillators.

Block Diagram



Output Enable Modes

| EN Pin | DSC8103 | DSC8123 |
|--------|----------------|------------------|
| High | Outputs Active | Outputs Active |
| NC | Outputs Active | Outputs Active |
| Low | Standby | Outputs Disabled |

Features

- **Low RMS Phase Jitter: <1 ps (typ)**
- **High Stability: ±10, ±25, ±50 ppm**
- **Wide Temperature Range**
 - Industrial: -40° to 85° C
 - Ext. commercial: -20° to 70° C
- **High Supply Noise Rejection: -50 dBc**
- **Short Lead Time: 2 Weeks**
- **Wide Freq. Range: 10 to 460 MHz**
- **Small Industry Standard Footprints**
 - 2.5x2.0, 3.2x2.5, 5.0x3.2, & 7.0x5.0 mm
- **Excellent Shock & Vibration Immunity**
 - Qualified to MIL-STD-883
- **High Reliability**
 - 20x better MTF than quartz oscillators
- **Low Current Consumption**
- **Supply Range of 2.25 to 3.6 V**
- **Standby & Output Enable Function**
- **Lead Free & RoHS Compliant**
- **LVPECL & HCSL Versions Available**
- **AEC-Q100 Automotive Qualified**

Applications

- **Storage Area Networks**
 - SATA, SAS, Fibre Channel
- **Passive Optical Networks**
 - EPON, 10G-EPON, GPON, 10G-PON
- **Ethernet**
 - 1G, 10GBASE-T/KR/LR/SR, and FCoE
- **HD/SD/SDI Video & Surveillance**
- **PCI Express: Gen 1 & Gen 2**
- **DisplayPort**

Absolute Maximum Ratings

| Item | Min | Max | Unit | Condition |
|----------------|------|--------------|------|------------|
| Supply Voltage | -0.3 | +4.0 | V | |
| Input Voltage | -0.3 | $V_{DD}+0.3$ | V | |
| Junction Temp | - | +150 | °C | |
| Storage Temp | -55 | +150 | °C | |
| Soldering Temp | - | +260 | °C | 40sec max. |
| ESD | - | | V | |
| HBM | | 4000 | | |
| MM | | 400 | | |
| CDM | | 1500 | | |

Note: 1000+ years of data retention on internal memory

Ordering Code

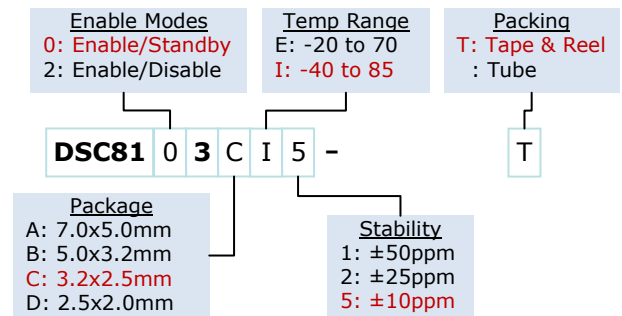

Specifications

| Parameter | Condition | Min. | Typ. | Max. | Unit |
|---|--|---------------------|--------------------|---------------------|-------------------|
| Supply Voltage ¹ | V_{DD} | 2.25 | | 3.6 | V |
| Supply Current | I_{DD} EN pin low – outputs are disabled DSC8103 DSC8123 | | 20 | 0.095 22 | mA |
| Frequency Stability | Δf Includes frequency variations due to initial tolerance, temp. and power supply voltage | | | ±10 ±25 ±50 | ppm |
| Aging | Δf 1 year @25°C | | | ±5 | ppm |
| Startup Time ² | t_{SU} T=25°C | | | 5 | ms |
| Input Logic Levels Input logic high Input logic low | V_{IH} V_{IL} | 0.75x V_{DD} - | | - 0.25x V_{DD} | V |
| Output Disable Time ³ | t_{DA} | | | 5 | ns |
| Output Enable Time | t_{EN} DSC8103 DSC8123 | | | 5 20 | ms ns |
| Enable Pull-Up Resistor ⁴ | Pull-up resistor exist | | 40 | | kΩ |
| LVDS Outputs | | | | | |
| Supply Current | I_{DD} Output Enabled, $R_L=50\Omega$ | | 29 | 32 | mA |
| Output offset Voltage | V_{OS} R=100Ω Differential | 1.125 | | 1.4 | V |
| Delta Offset Voltage | ΔV_{OS} | | | 50 | mV |
| Pk to Pk Output Swing | V_{PP} Single-Ended | | 350 | | mV |
| Output Transition time ³ Rise Time Fall Time | t_R t_F 20% to 80% $R_L=50\Omega$, $C_L=2pF$ | | 200 | | ps |
| Frequency | f_0 Single Frequency | 10 | | 460 | MHz |
| Output Duty Cycle | SYM Differential | 48 | | 52 | % |
| Period Jitter | J_{PER} | | 2.5 | | ps _{RMS} |
| Integrated Phase Noise | J_{PH} 200kHz to 20MHz @156.25MHz 100kHz to 20MHz @156.25MHz 12kHz to 20MHz @156.25MHz | | 0.28 0.4 1.7 | 2 | ps _{RMS} |

Notes:

- Pin 6 V_{DD} should be filtered with 0.1uF capacitor.
- t_{SU} is time to 100ppm of output frequency after V_{DD} is applied and outputs are enabled.
- Output Waveform and Test Circuit figures below define the parameters.
- Output is enabled if pad is floated or not connected.

Nominal Performance Parameters (Unless specified otherwise: T=25° C, V_{DD}=3.3 V)

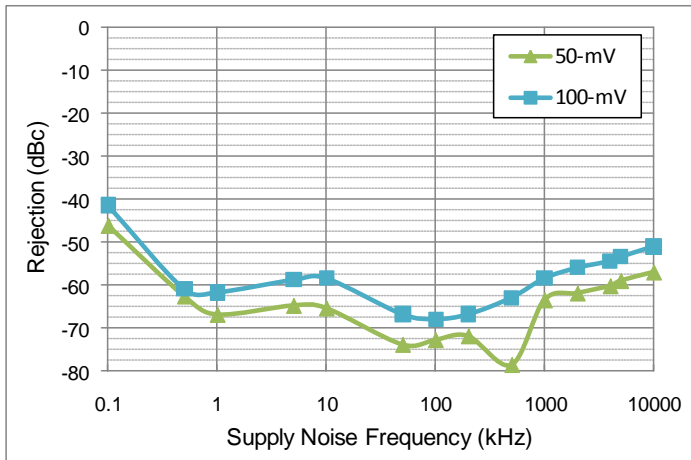

Power supply rejection ratio

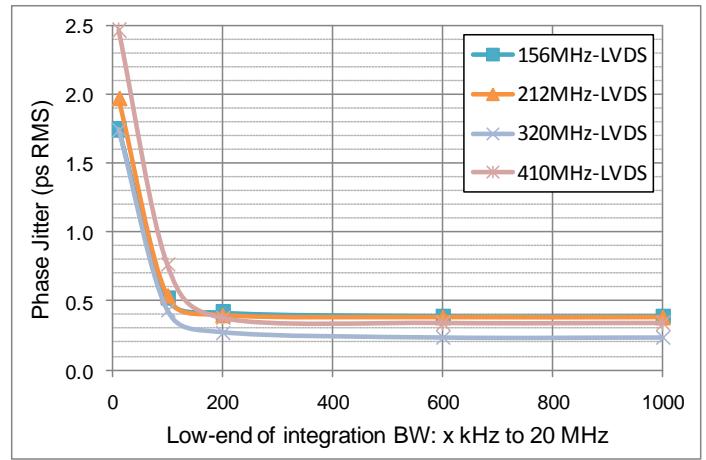

Phase jitter (integrated phase noise)

Output Waveform

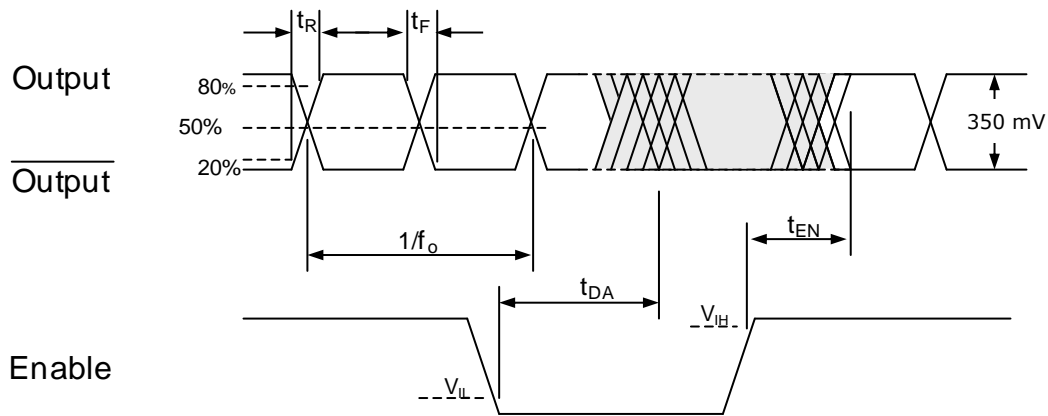

Typical Termination Scheme

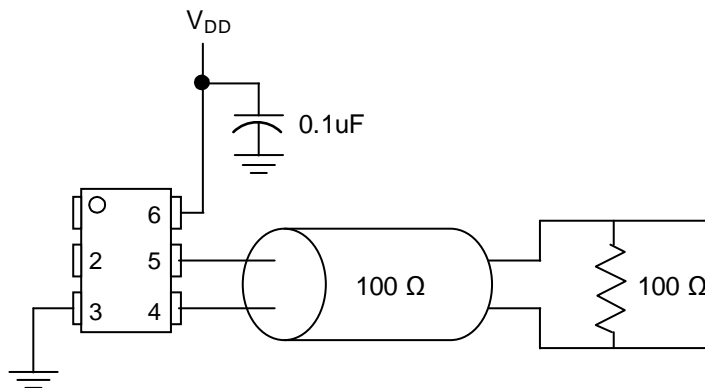

Test Circuit

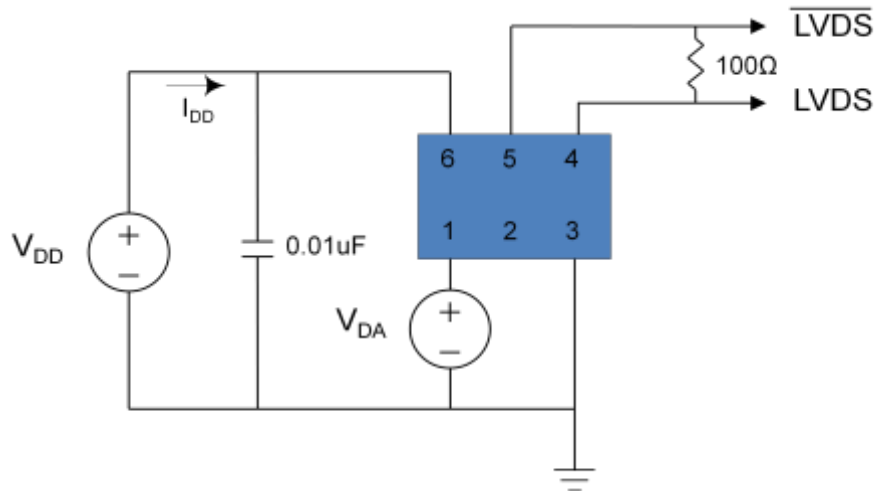

Solder Reflow Profile

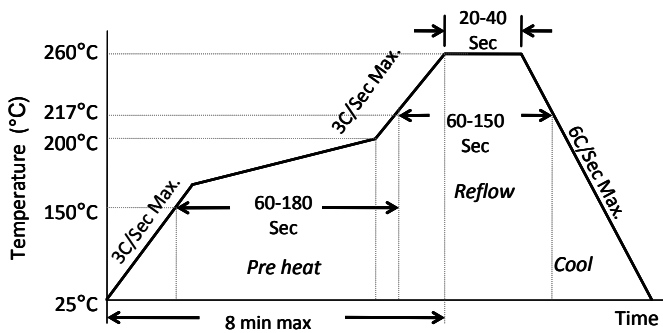

| MSL 1 @ 260°C refer to JSTD-020C | |
|-----------------------------------|--------------|
| Ramp-Up Rate (200°C to Peak Temp) | 3°C/Sec Max. |
| Preheat Time 150°C to 200°C | 60-180 Sec |
| Time maintained above 217°C | 60-150 Sec |
| Peak Temperature | 255-260°C |
| Time within 5°C of actual Peak | 20-40 Sec |
| Ramp-Down Rate | 6°C/Sec Max. |
| Time 25°C to Peak Temperature | 8 min Max. |

Package Dimensions

7.0 x 5.0 mm Plastic Package

External Dimensions
units: mm[inch]

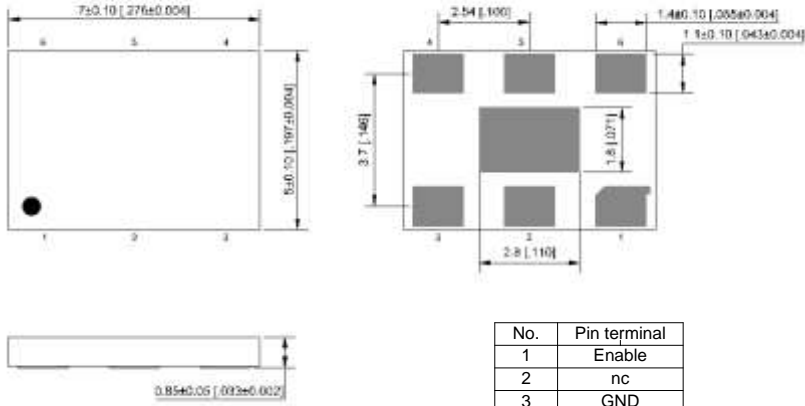

| No. | Pin terminal |
|-----|--------------|
| 1 | Enable |
| 2 | nc |
| 3 | GND |
| 4 | Output |
| 5 | Output |
| 6 | VDD |

Recommended Solder Pad Layout
units: mm[inch]

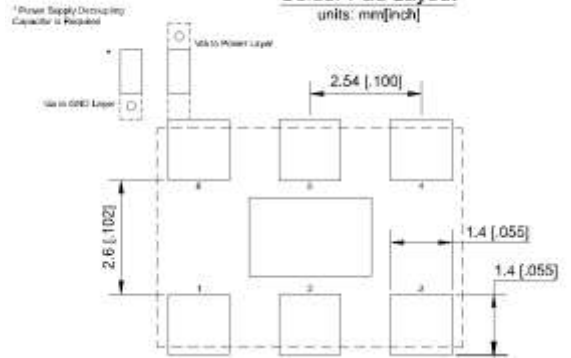

5.0 x 3.2 mm Plastic Package

External Dimensions
units: mm[inch]

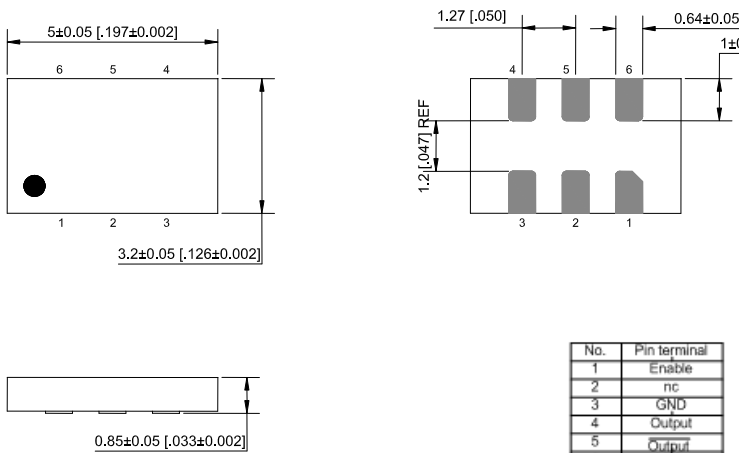

| No. | Pin terminal |
|-----|--------------|
| 1 | Enable |
| 2 | nc |
| 3 | GND |
| 4 | Output |
| 5 | Output |
| 6 | VDD |

Recommended Solder Pad Layout
units: mm[inch]

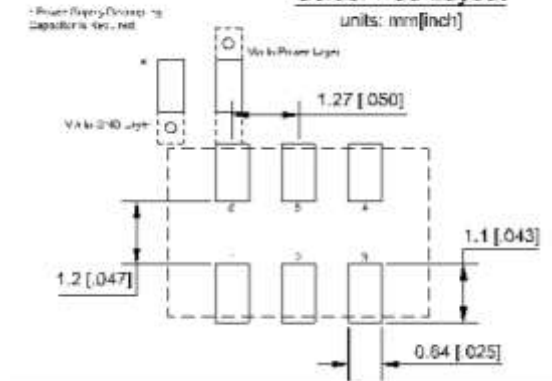

3.2 x 2.5 mm Plastic Package

External Dimensions

units: mm[inch]

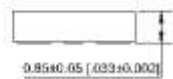
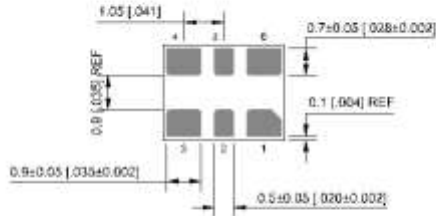
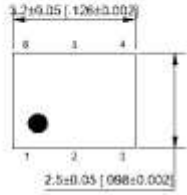

| No. | Pin terminal |
|-----|--------------|
| 1 | Enable |
| 2 | nc |
| 3 | GND |
| 4 | Output |
| 5 | Output |
| 6 | VDD |

Recommended Solder Pad Layout

units: mm[inch]

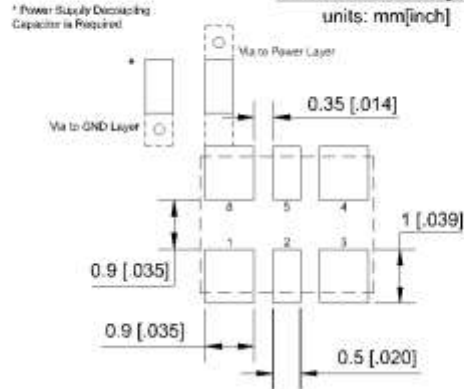

2.5 x 2.0 mm Plastic Package

2.5±0.05 [0.098±0.002]

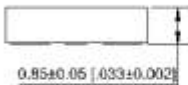
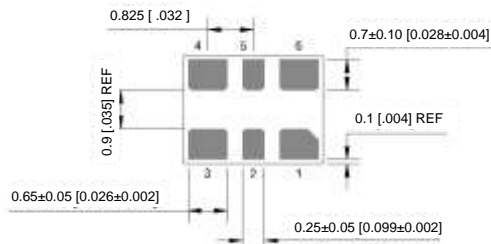
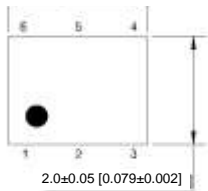

| No. | Pin terminal |
|-----|--------------|
| 1 | Enable |
| 2 | nc |
| 3 | GND |
| 4 | Output |
| 5 | Output |
| 6 | VDD |

Recommended Solder Pad Layout

units: mm[inch]

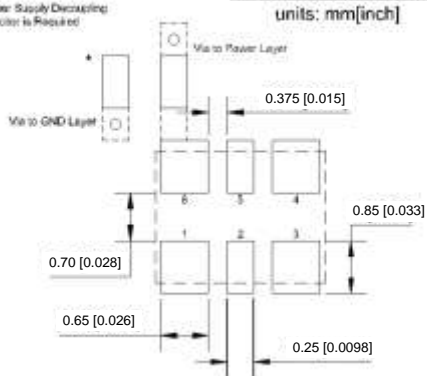

Disclaimer:

Micrel makes no representations or warranties with respect to the accuracy or completeness of the information furnished in this data sheet. This information is not intended as a warranty and Micrel does not assume responsibility for its use. Micrel reserves the right to change circuitry, specifications and descriptions at any time without notice. No license, whether express, implied, arising by estoppel or otherwise, to any intellectual property rights is granted by this document. Except as provided in Micrel's terms and conditions of sale for such products, Micrel assumes no liability whatsoever, and Micrel disclaims any express or implied warranty relating to the sale and/or use of Micrel products including liability or warranties relating to fitness for a particular purpose, merchantability, or infringement of any patent, copyright or other intellectual property right.

MICREL, Inc.
Phone: +1 (408) 944-0800

•

2180 Fortune Drive,
Fax: +1 (408) 474-1000

•

San Jose, California 95131
• Email: hbwhelp@micrel.com

•

USA
www.micrel.com



Стандарт Электрон Связь

Мы молодая и активно развивающаяся компания в области поставок электронных компонентов. Мы поставляем электронные компоненты отечественного и импортного производства напрямую от производителей и с крупнейших складов мира.

Благодаря сотрудничеству с мировыми поставщиками мы осуществляем комплексные и плановые поставки широчайшего спектра электронных компонентов.

Собственная эффективная логистика и склад в обеспечивает надежную поставку продукции в точно указанные сроки по всей России.

Мы осуществляем техническую поддержку нашим клиентам и предпродажную проверку качества продукции. На все поставляемые продукты мы предоставляем гарантию .

Осуществляем поставки продукции под контролем ВП МО РФ на предприятия военно-промышленного комплекса России , а также работаем в рамках 275 ФЗ с открытием отдельных счетов в уполномоченном банке. Система менеджмента качества компании соответствует требованиям ГОСТ ISO 9001.

Минимальные сроки поставки, гибкие цены, неограниченный ассортимент и индивидуальный подход к клиентам являются основой для выстраивания долгосрочного и эффективного сотрудничества с предприятиями радиоэлектронной промышленности, предприятиями ВПК и научно-исследовательскими институтами России.

С нами вы становитесь еще успешнее!

Наши контакты:

Телефон: +7 812 627 14 35

Электронная почта: sales@st-electron.ru

Адрес: 198099, Санкт-Петербург,
Промышленная ул, дом № 19, литера Н,
помещение 100-Н Офис 331