

IR-Lumineszenzdiode (850 nm) mit hoher Ausgangsleistung
High Power Infrared Emitter (850 nm)
Lead (Pb) Free Product - RoHS Compliant

SFH 4258S
SFH 4259S



Wesentliche Merkmale

- Infrarot LED mit hoher Ausgangsleistung
- Halbwinkel SFH 4258S: $\pm 15^\circ$
- Halbwinkel SFH 4259S: $\pm 25^\circ$
- Hohe Bestromung bei hohen Temperaturen möglich
- Kurze Schaltzeiten

Anwendungen

- Industrie Anwendungen
- Infrarotbeleuchtung für Kameras
- IR-Datenübertragung
- Sensorik

Sicherheitshinweise

Je nach Betriebsart emittieren diese Bauteile hochkonzentrierte, nicht sichtbare Infrarot-Strahlung, die gefährlich für das menschliche Auge sein kann. Produkte, die diese Bauteile enthalten, müssen gemäß den Sicherheitsrichtlinien der IEC-Normen 60825-1 und 62471 behandelt werden.

Features

- High Power Infrared LED
- Half angle SFH 4258S: $\pm 15^\circ$
- Half angle SFH 4259S: $\pm 25^\circ$
- High forward current allowed at high temperature
- Short switching times

Applications

- industrial applications
- Infrared Illumination for cameras
- IR Data Transmission
- Optical sensors

Safety Advices

Depending on the mode of operation, these devices emit highly concentrated non visible infrared light which can be hazardous to the human eye. Products which incorporate these devices have to follow the safety precautions given in IEC 60825-1 and IEC 62471.

Typ Type	Bestellnummer Ordering Code	Strahlstärkegruppierung ¹⁾ ($I_F = 70 \text{ mA}$, $t_p = 20 \text{ ms}$) Radiant Intensity Grouping ¹⁾ $I_e \text{ (mW/sr)}$
SFH 4258S	Q65111A1158	≥ 40 (typ. 100)
SFH 4259S	Q65111A1159	≥ 25 (typ. 60)

¹⁾ gemessen bei einem Raumwinkel $\Omega = 0.01 \text{ sr}$ / measured at a solid angle of $\Omega = 0.01 \text{ sr}$

Grenzwerte ($T_A = 25\text{ °C}$)**Maximum Ratings**

Bezeichnung Parameter	Symbol Symbol	Wert Value	Einheit Unit
Betriebs- und Lagertemperatur Operating and storage temperature range	T_{op}, T_{stg}	- 40 ... + 85	°C
Sperrspannung Reverse voltage	V_R	5	V
Vorwärtsgleichstrom Forward current	I_F	70	mA
Stoßstrom, $t_p = 300\ \mu\text{s}$, $D = 0$ Surge current	I_{FSM}	700	mA
Verlustleistung Power dissipation	P_{tot}	245	mW
Wärmewiderstand Sperrschicht - Umgebung bei Montage auf FR4 Platine, Padgröße je $16\ \text{mm}^2$ Thermal resistance junction - ambient mounted on PC-board (FR4), pads size $16\ \text{mm}^2$ each	R_{thJA}	300	K/W
Wärmewiderstand Sperrschicht - Lötstelle bei Montage auf Metall-Block Thermal resistance junction - soldering point, mounted on metal block	R_{thJS}	140	K/W

Kennwerte ($T_A = 25\text{ °C}$)**Characteristics**

Bezeichnung Parameter	Symbol Symbol	Wert Value	Einheit Unit
Wellenlänge der Strahlung Wavelength at peak emission $I_F = 70\ \text{mA}$	λ_{peak}	860	nm
Centroid-Wellenlänge der Strahlung Centroid wavelength $I_F = 70\ \text{mA}$	$\lambda_{centroid}$	850	nm
Spektrale Bandbreite bei 50% von I_{max} Spectral bandwidth at 50% of I_{max} $I_F = 70\ \text{mA}$	$\Delta\lambda$	30	nm
Abstrahlwinkel Half angle SFH 4258S SFH 4259S	φ φ	± 15 ± 25	Grad deg.

Kennwerte ($T_A = 25\text{ °C}$)
Characteristics (cont'd)

Bezeichnung Parameter	Symbol Symbol	Wert Value	Einheit Unit
Aktive Chipfläche Active chip area	A	0.09	mm ²
Abmessungen der aktiven Chipfläche Dimension of the active chip area	$L \times B$ $L \times W$	0.3×0.3	mm ²
Schaltzeiten, I_e von 10% auf 90% und von 90% auf 10%, bei $I_F = 70\text{ mA}$, $R_L = 50\ \Omega$ Switching times, I_e from 10% to 90% and from 90% to 10%, $I_F = 70\text{ mA}$, $R_L = 50\ \Omega$	t_r, t_f	15	ns
Durchlassspannung Forward voltage $I_F = 70\text{ mA}$, $t_p = 20\text{ ms}$ $I_F = 700\text{ mA}$, $t_p = 100\ \mu\text{s}$	V_F V_F	3 (< 3.5) 4 (< 5.2)	V V
Sperrstrom Reverse current	I_R	not designed for reverse operation	μA
Gesamtstrahlungsfluss Total radiant flux $I_F = 70\text{ mA}$, $t_p = 20\text{ ms}$	$\Phi_{e\text{ typ}}$	80	mW
Temperaturkoeffizient von I_e bzw. Φ_e , $I_F = 70\text{ mA}$ Temperature coefficient of I_e or Φ_e , $I_F = 70\text{ mA}$	TC_I	- 0.5	%/K
Temperaturkoeffizient von V_F , $I_F = 70\text{ mA}$ Temperature coefficient of V_F , $I_F = 70\text{ mA}$	TC_V	- 2	mV/K
Temperaturkoeffizient von λ , $I_F = 70\text{ mA}$ Temperature coefficient of λ , $I_F = 70\text{ mA}$	TC_λ	+ 0.3	nm/K

Strahlstärke I_e in Achsrichtung¹⁾

gemessen bei einem Raumwinkel $\Omega = 0.01$ sr

Radiant Intensity I_e in Axial Direction

at a solid angle of $\Omega = 0.01$ sr

Bezeichnung Parameter	Symbol	Werte Values			Einheit Unit
		SFH 4258S -U	SFH 4258S -V	SFH 4258S -AW	
Strahlstärke Radiant intensity $I_F = 70$ mA, $t_p = 20$ ms	$I_{e \text{ min}}$	40	63	100	mW/sr
	$I_{e \text{ max}}$	80	125	200	mW/sr
Strahlstärke Radiant intensity $I_F = 700$ mA, $t_p = 25$ μ s	$I_{e \text{ typ}}$	480	750	1200	mW/sr
		SFH 4259S -T	SFH 4259S -U	SFH 4259S -V	
Strahlstärke Radiant intensity $I_F = 70$ mA, $t_p = 20$ ms	$I_{e \text{ min}}$	25	40	63	mW/sr
	$I_{e \text{ max}}$	50	80	125	mW/sr
Strahlstärke Radiant intensity $I_F = 700$ mA, $t_p = 25$ μ s	$I_{e \text{ typ}}$	300	480	750	mW/sr

¹⁾ Nur eine Gruppe in einer Verpackungseinheit (Streuung kleiner 2:1) /
Only one bin in one packing unit (variation lower 2:1)

Abstrahlcharakteristik

Radiation Characteristics $I_{rel} = f(\varphi)$

SFH 4258S

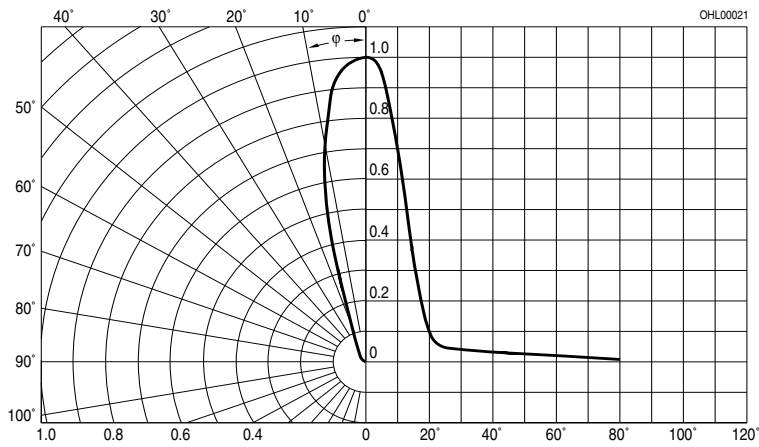

Abstrahlcharakteristik

Radiation Characteristics $I_{rel} = f(\varphi)$

SFH 4259S

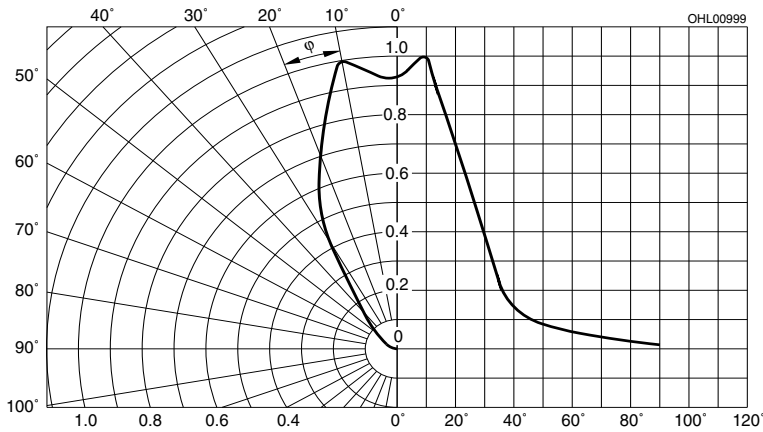

Relative Spectral Emission

$I_{rel} = f(\lambda)$

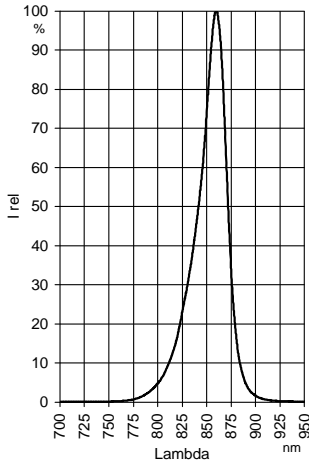

Radiant Intensity $\frac{I_e}{I_e 70 \text{ mA}} = f(I_F)$

Single pulse, $t_p = 25 \mu\text{s}$

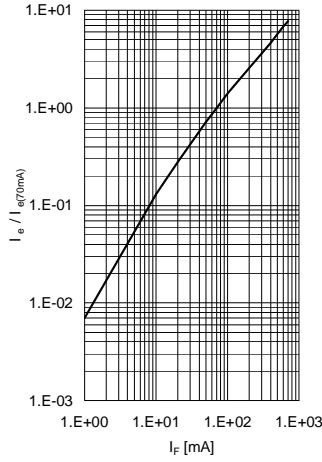

Max. Permissible Forward Current

$I_F = f(T_A), R_{thJA} = 300 \text{ K/W}$

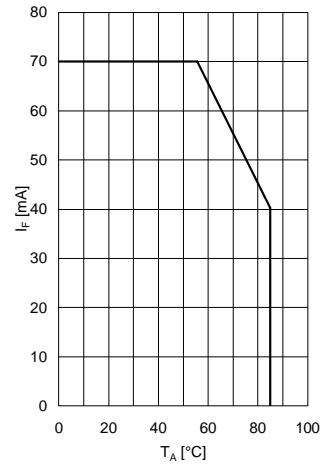

Forward Current $I_F = f(V_F)$

Single pulse, $t_p = 100 \mu\text{s}$

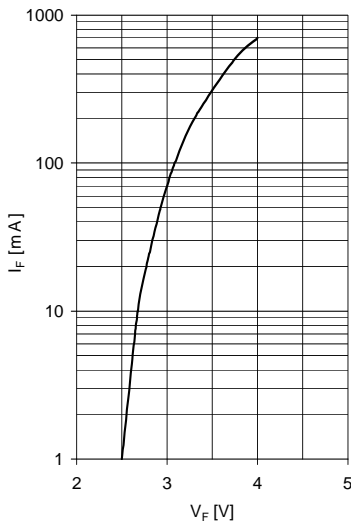

Permissible Pulse Handling Capability

$I_F = f(\tau), T_A = 25^\circ\text{C}$,
duty cycle $D = \text{parameter}$

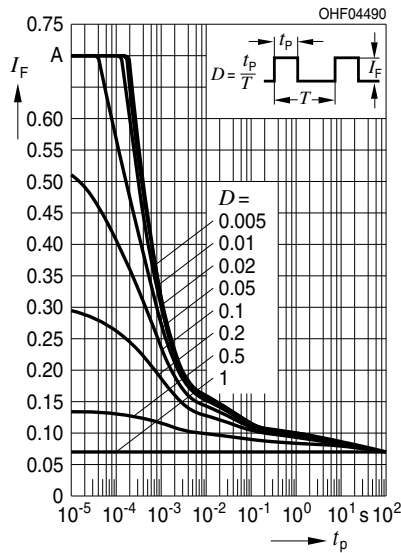

Permissible Pulse Handling Capability

$I_F = f(\tau), T_A = 85^\circ\text{C}$,
duty cycle $D = \text{parameter}$

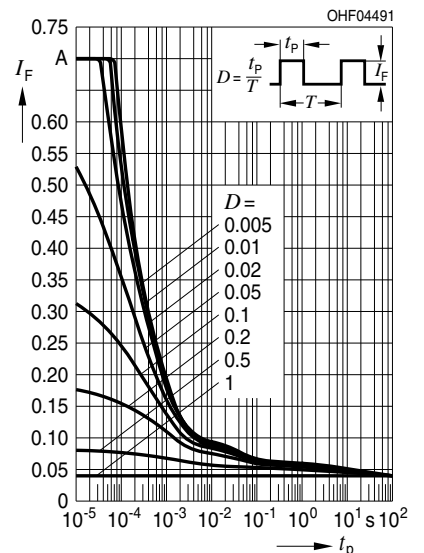

Maßzeichnung
Package Outlines

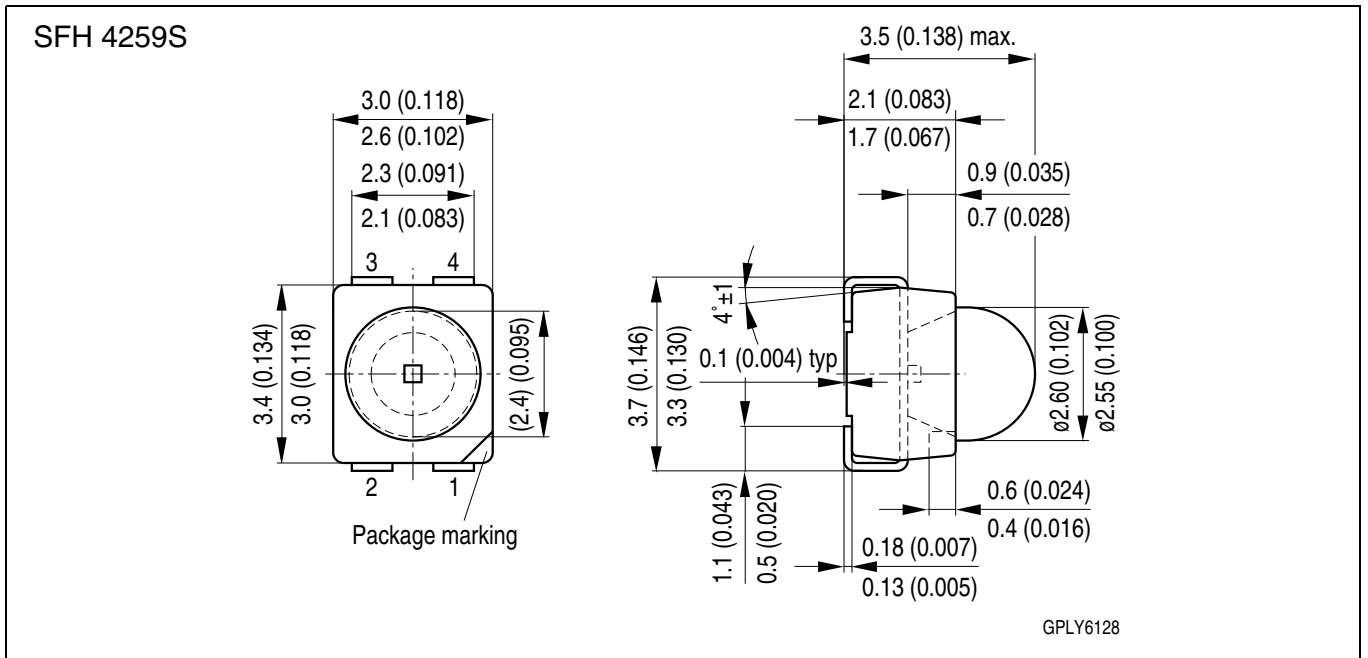
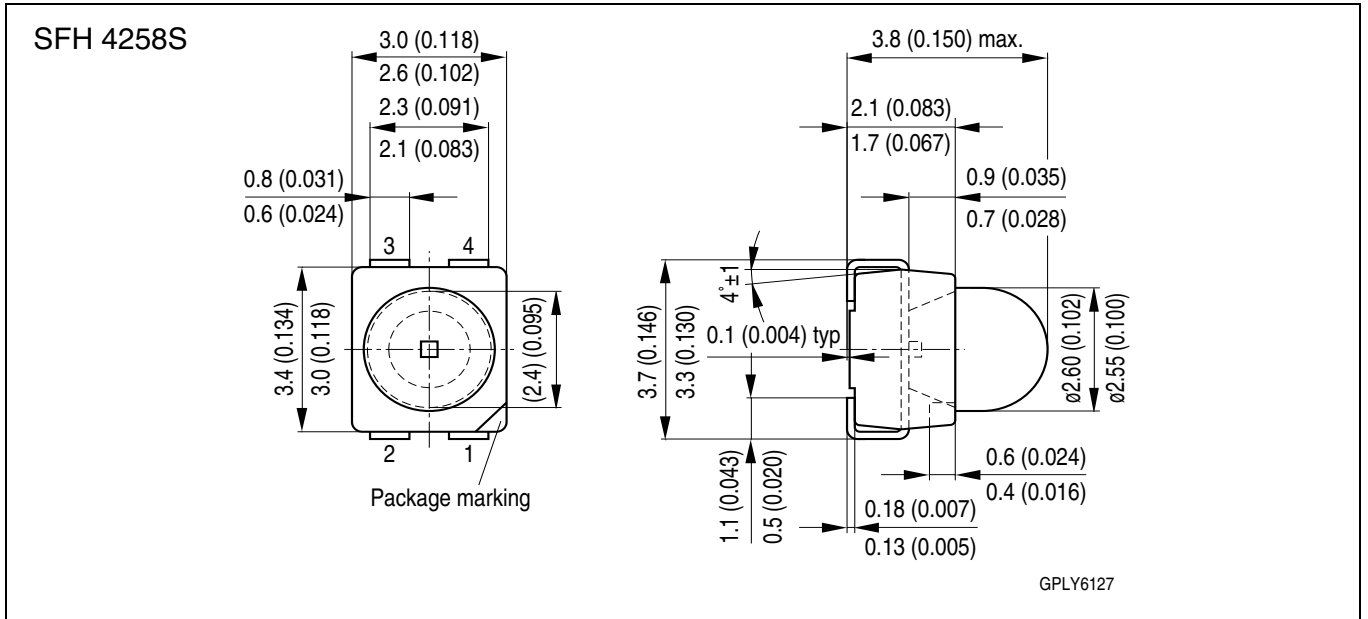

Maße in mm (inch) / Dimensions in mm (inch).

Gehäuse / Package	Power TOPLED® mit Linse, klarer Verguss / Power TOPLED® with lens, clear resin
Anschlussbelegung pin configuration	1 = Kathode / cathode 2/3/4 = Anode / anode

Empfohlenes Lötpaddesign
Recommended Solder Pad Design

Reflow Löten
 Reflow Soldering

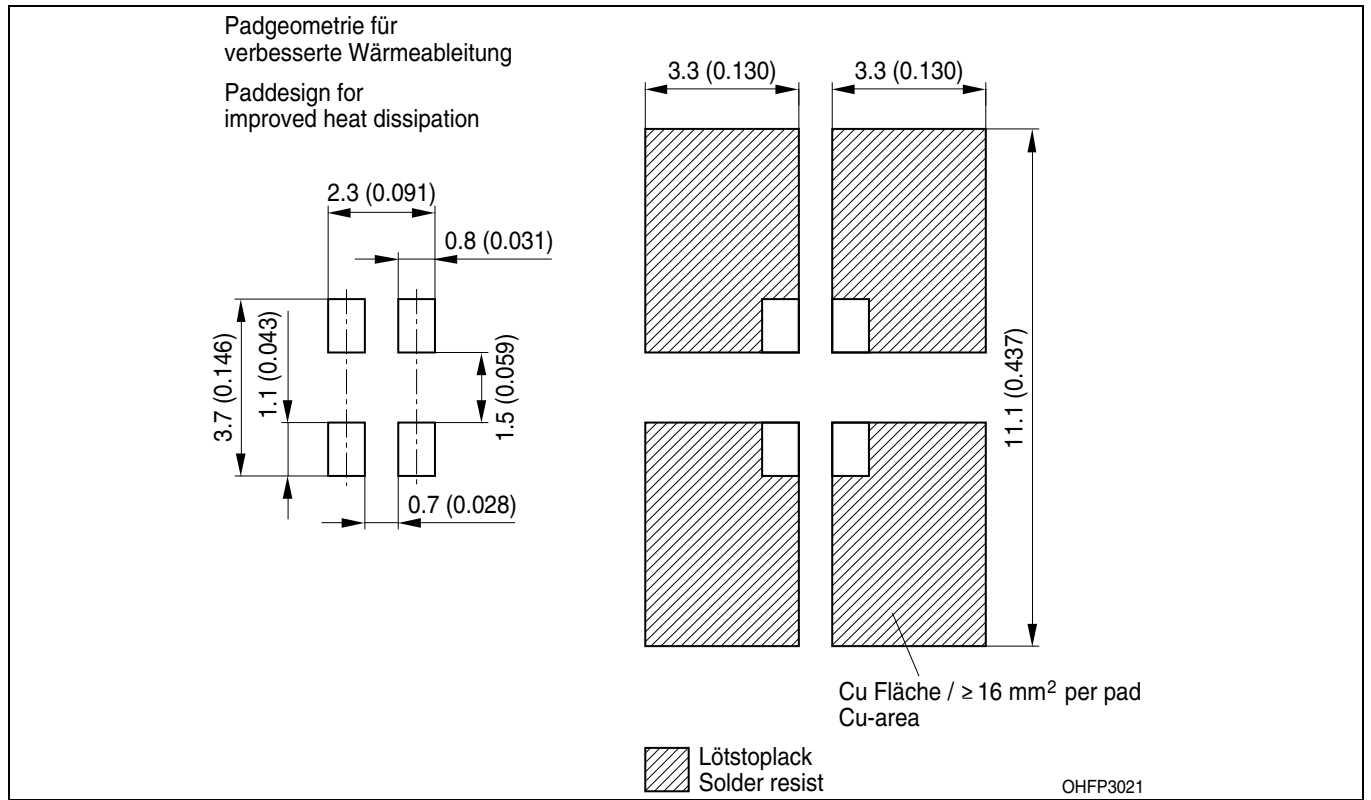

Empfohlenes Lötpaddesign
Recommended Solder Pad Design

Wellenlöten TTW
 TTW Soldering

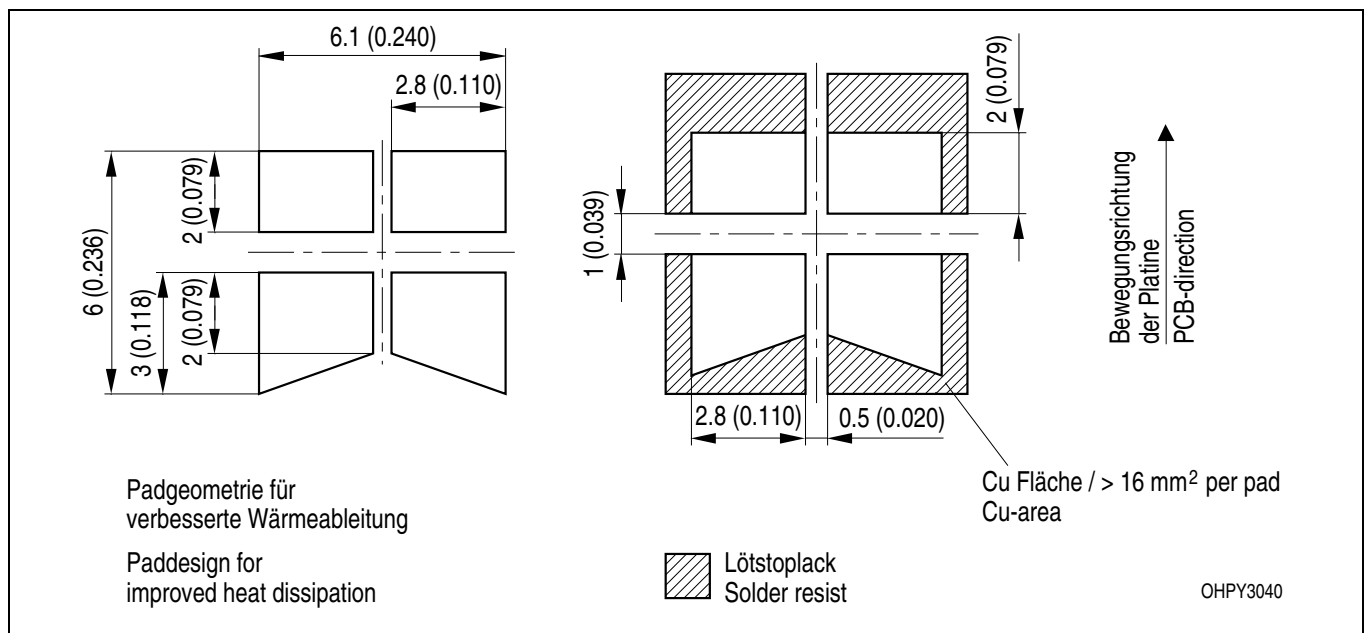

Lötbedingungen
Soldering Conditions
Reflow Lötprofil für bleifreies Löten
Reflow Soldering Profile for lead free soldering

Vorbehandlung nach JEDEC Level 2
 Preconditioning acc. to JEDEC Level 2
 (nach J-STD-020D.01)
 (acc. to J-STD-020D.01)

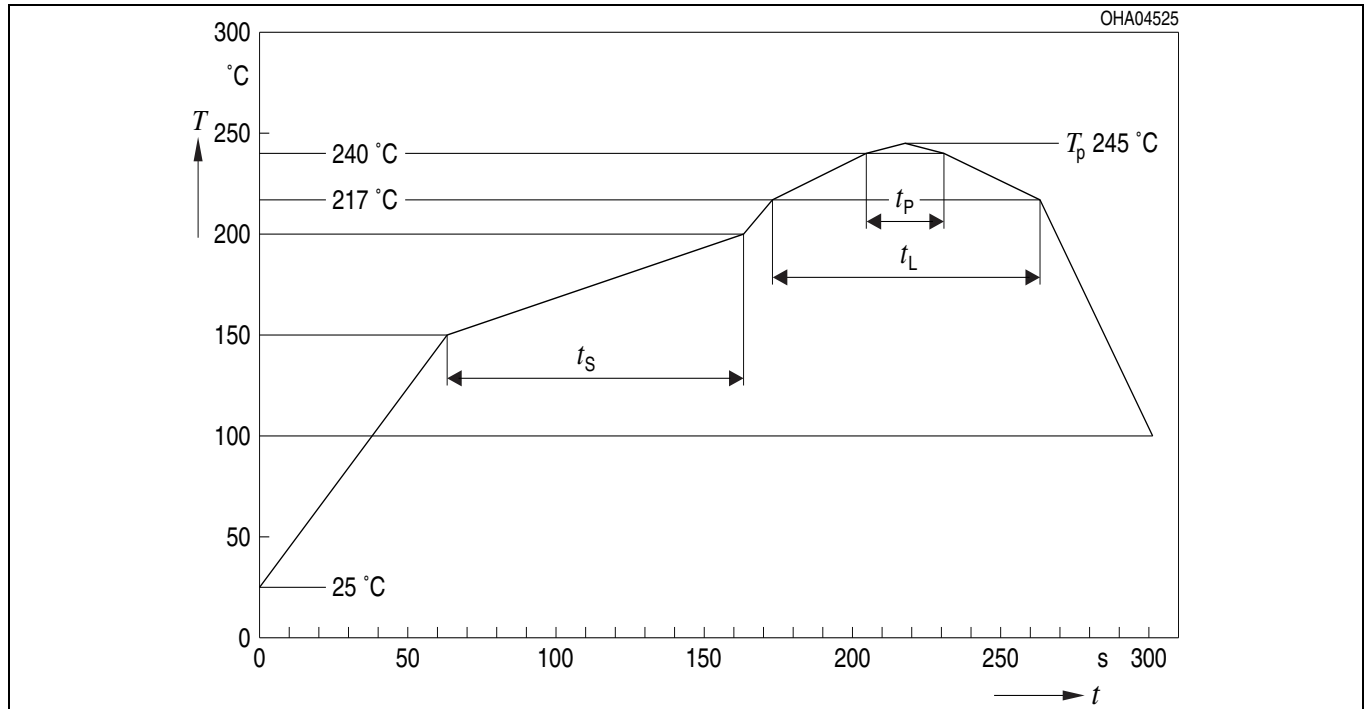

Profileigenschaften Profile Feature	Bleifreier Aufbau / Pb-Free Assembly (SnAgCu)	
	Empfehlung / Recommendation	Grenzwerte / Max. Ratings
Aufheizrate zum Vorwärmen*) / Ramp-up rate to preheat*) 25 °C to 150 °C	2 K / s	3 K / s
Zeit t _s von T _{Smin} bis T _{Smax} / Time t _s from T _{Smin} to T _{Smax} 150 °C to 200 °C	100 s	min. 60 s max. 120 s
Aufheizrate zur Spitzentemperatur*) / Ramp-up rate to peak*) 180 °C to T _p	2 K / s	3 K / s
Liquidustemperatur T _L / Liquidus temperature T _L	217 °C	
Zeit t _L über T _L / Time t _L above T _L	80 s	max. 100 s
Spitzentemperatur T _p / Peak temperature T _p	245 °C	max. 250 °C
Verweilzeit t _p innerhalb des spezifizierten Spitzentemperaturbereichs T _p - 5 K / Time t _p within the specified peak temperature range T _p - 5 K	20 s	min. 10 s max. 30 s
Abkühlrate*) / Ramp-down rate*) T _p to 100 °C	3 K / s	4 K / s maximum
Zeitspanne von 25 °C bis zur Spitzentemperatur / Time from 25 °C to peak temperature		max. 8 min.

Alle Temperaturen beziehen sich auf die Bauteilmitte, jeweils auf der Bauteiloberseite gemessen / All temperatures refer to the center of the package, measured on the top of the package

* Steigungsberechnung $\Delta T/\Delta t$: Δt max. 5 s; erfüllt über den gesamten Temperaturbereich / slope calculation $\Delta T/\Delta t$: Δt max. 5 s; fulfillment for the whole T-range

Wellenlöten (TTW)
TTW Soldering

(nach CECC 00802)
(acc. to CECC 00802)

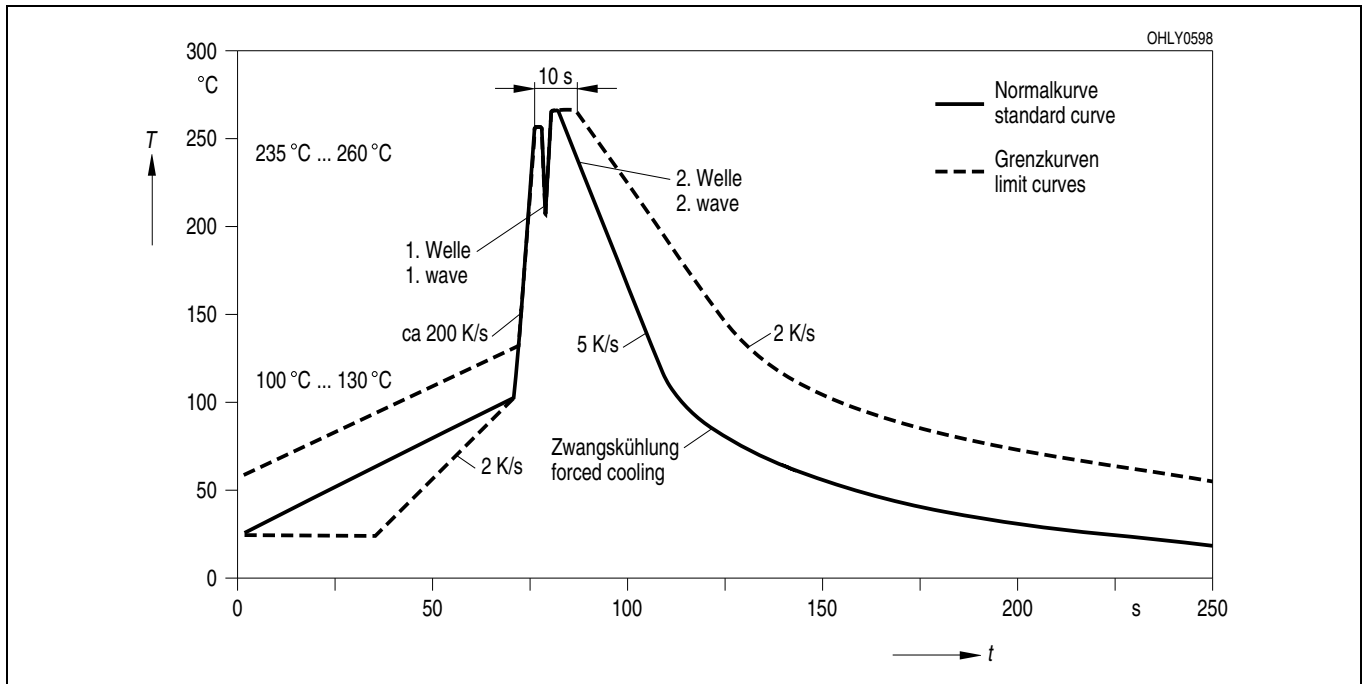

Published by
OSRAM Opto Semiconductors GmbH
Leibnizstraße 4, D-93055 Regensburg
www.osram-os.com

© All Rights Reserved.

The information describes the type of component and shall not be considered as assured characteristics. Terms of delivery and rights to change design reserved. Due to technical requirements components may contain dangerous substances. For information on the types in question please contact our Sales Organization.

Packing

Please use the recycling operators known to you. We can also help you – get in touch with your nearest sales office. By agreement we will take packing material back, if it is sorted. You must bear the costs of transport. For packing material that is returned to us unsorted or which we are not obliged to accept, we shall have to invoice you for any costs incurred.

Components used in life-support devices or systems must be expressly authorized for such purpose! Critical components ¹, may only be used in life-support devices or systems ² with the express written approval of OSRAM OS.

¹ A critical component is a component used in a life-support device or system whose failure can reasonably be expected to cause the failure of that life-support device or system, or to affect its safety or effectiveness of that device or system.

² Life support devices or systems are intended (a) to be implanted in the human body, or (b) to support and/or maintain and sustain human life. If they fail, it is reasonable to assume that the health of the user may be endangered.

EU RoHS and China RoHS compliant product



此产品符合欧盟 RoHS 指令的要求；

按照中国的相关法规和标准，不含有毒有害物质或元素。



Стандарт Электрон Связь

Мы молодая и активно развивающаяся компания в области поставок электронных компонентов. Мы поставляем электронные компоненты отечественного и импортного производства напрямую от производителей и с крупнейших складов мира.

Благодаря сотрудничеству с мировыми поставщиками мы осуществляем комплексные и плановые поставки широчайшего спектра электронных компонентов.

Собственная эффективная логистика и склад в обеспечивает надежную поставку продукции в точно указанные сроки по всей России.

Мы осуществляем техническую поддержку нашим клиентам и предпродажную проверку качества продукции. На все поставляемые продукты мы предоставляем гарантию .

Осуществляем поставки продукции под контролем ВП МО РФ на предприятия военно-промышленного комплекса России , а также работаем в рамках 275 ФЗ с открытием отдельных счетов в уполномоченном банке. Система менеджмента качества компании соответствует требованиям ГОСТ ISO 9001.

Минимальные сроки поставки, гибкие цены, неограниченный ассортимент и индивидуальный подход к клиентам являются основой для выстраивания долгосрочного и эффективного сотрудничества с предприятиями радиоэлектронной промышленности, предприятиями ВПК и научно-исследовательскими институтами России.

С нами вы становитесь еще успешнее!

Наши контакты:

Телефон: +7 812 627 14 35

Электронная почта: sales@st-electron.ru

Адрес: 198099, Санкт-Петербург,
Промышленная ул, дом № 19, литера Н,
помещение 100-Н Офис 331