

CPG004_DRV88xx Evaluation Modules

This document is provided as a supplement to the DRV8802, DRV8812, DRV8813, DRV8814, DRV8824, DRV8825, DRV8841 and DRV8843 datasheets. It details the hardware implementation of the CPG004 DRV88xxEVM Customer Evaluation Module (EVM). On this document, DRV88xx will be used interchangeably to refer to any of the aforementioned devices.

Contents

1	Block Diagram	2
	1.1 Power Connectors	2
	1.2 Test Stakes	2
	1.3 Jumpers	3
	1.4 Motor Outputs	4
2	Installing Drivers And Software	5
	2.1 Installing the FTDI USB Driver	5
	2.2 Installing the CPG004_DRV88xx Evaluation Board Windows Application Software	5
	2.3 Running the Windows Application Software	5
3	The Windows Application	5
	3.1 The Menu	7
	3.2 DRV88xx GPIO Control Signals	7
	3.3 Updating DAC Output for Current Control (VREFA and VREFB)	8
	3.4 DC Motor Speed Control (PWM)	8
	3.5 Operating the Stepper Motor (DRV8824)	9
4	Schematics	12

List of Figures

1	AVREF Select Jumper Configuration	3
2	BVREF Select Jumper Configuration	3
3	DECAY Select Jumper Configuration	4
4	DRV8802-12-13-14 Tab.....	5
5	DRV8824-25 GUI	6
6	DRV8841-43 Tab	6
7	GPIO Control Signals.....	7
8	Current Control	8
9	Duty Cycle Indicator	8
10	PWM Signal on INx Pins.....	9
11	Turning the Stepper Motor	10
12	Speed Control.....	10
13	Step Control.....	11
14	Stepper Speed Calculator.....	11

List of Tables

1	BVREF Default Jumper Allocation on a Per Device Basis	4
---	---	---

1 Block Diagram

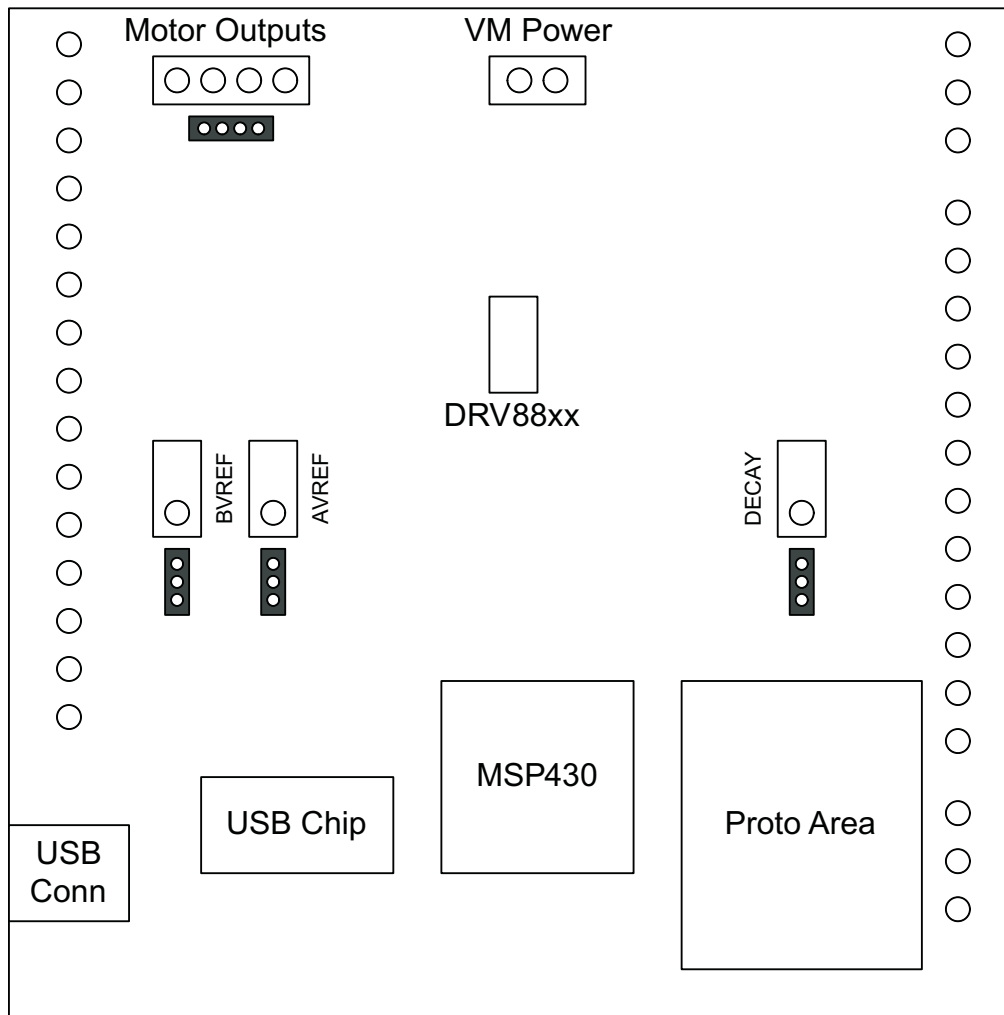

Where DRV88xx stands for one of DRV8802, DRV8812, DRV8813, DRV8814, DRV8824, DRV8825, DRV8841 or DRV8843.

1.1 Power Connectors

The DRV88xx Customer EVM offers access to VM (Motor Voltage) power rail via a terminal block (J1). A set of test clips in parallel with the terminal block allows for the monitoring of the input power rail.

User must apply VM according to datasheet recommended parameters.

NOTE: VDD for logic and microcontroller is derived from USB interface.

1.2 Test Stakes

Every pin on the DRV88xx device has been brought out to a test stake. A label on the silkscreen identifies each signal.

For those pins that change functionality depending on device flavor, a table is provided with corresponding function name on its particular column.

1.3 Jumpers

There are only three jumpers the user must configure as detailed below. Default configuration assumes microcontroller resources are being utilized. As an alternative, a variable resistance is provided on the opposing jumper configuration.

1.3.1 AVREF Select Jumper (JP2)

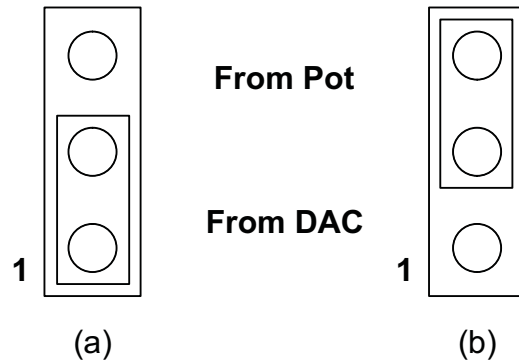

To configure the AVREF select jumper:
 (a) Use position JP2-1:2 to select the MSP430 DAC output (default).
 (b) Use position JP2-2:3 to select the respective variable resistance potentiometer. This jumper should not be left open as lack of reference voltage on the device will minimize current sourcing into the respective H Bridge, resulting in very poor motion or no motion at all.

Figure 1. AVREF Select Jumper Configuration

1.3.2 BVREF Select Jumper (JP1)

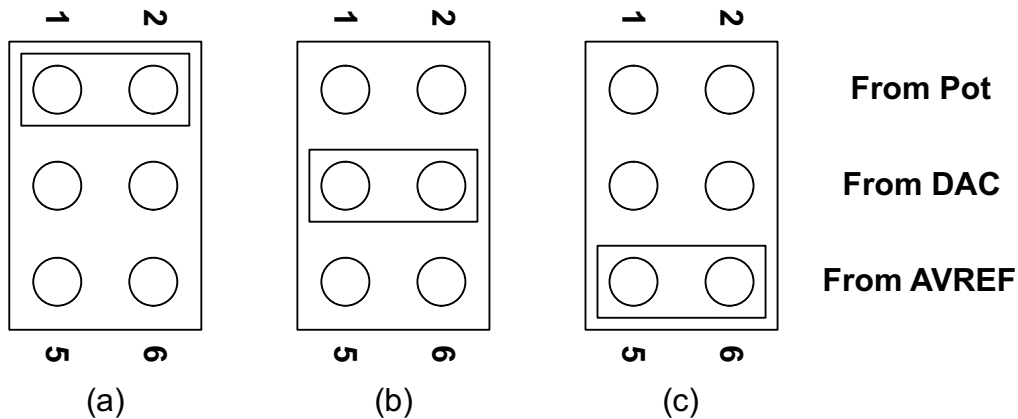

To configure the BVREF select jumper:
 (a) Use position JP1-1:2 to select the respective variable resistance potentiometer.
 (b) Use position JP1-2:3 to select the MSP430 DAC functionality.
 (c) Use position JP1-5:6 to select AVREF as reference voltage source. This jumper should not be left open as lack of a reference voltage on the device will minimize current sourcing into the respective H Bridge, resulting in very poor motion or no motion at all.

Figure 2. BVREF Select Jumper Configuration

1.3.2.1 BVREF Default Jumper Allocation

Table 1. BVREF Default Jumper Allocation on a Per Device Basis

DEVICE	BVREF JUMPER DEFAULT
DRV8802/12/13/14	JP1-3:4
DRV8824/25	JP1-5:6
DRV8841/43	JP1-3:4

1.3.3 DECAY Select Jumper (JP3)

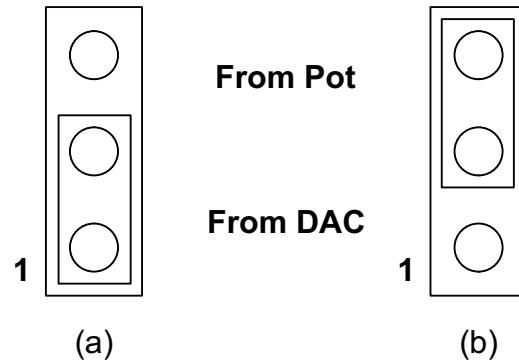

To configure the DECAY select jumper:

- (a) Use position JP3-1:2 to select the MSP430 GPIO functionality (default).
- (b) Use position JP3-2:3 to select the respective variable resistance potentiometer. Allowing the jumper to not be placed, will result in the device operating under mixed decay mode.

Figure 3. DECAY Select Jumper Configuration

1.4 Motor Outputs

There are two ways of connecting the different motor styles (single bipolar stepper motor or two DC motors) into the CPG004_DRV88xx Evaluation Module: four pin header (J4) and four position terminal block (J3). Although feasible, we do not recommend the connection of any motor into the test clips as these are Kelvin connections and not rated for high current output.

2 Installing Drivers And Software

2.1 Installing the FTDI USB Driver

Instructions on how to install the FTDI USB driver on a Windows based computer are detailed in the “USB_Drivers_Install_Readme.pdf” file supplied with the CD inside the USB_Driver folder.

2.2 Installing the CPG004_DRV88xx Evaluation Board Windows Application Software

Copy the contents of the “WindowsApplication” folder provided within the CD, into your hard disk.

2.3 Running the Windows Application Software

To run the application, double click the CPG004_DRV88xxEVM_R0p2.exe application icon found on the same folder the application was extracted into.

3 The Windows Application

The CPG004_DRV88xxEVM Windows application is the software counterpart for the CPG004_DRV88xx EVM. It allows the PC computer to connect to the MSP430F1612 microcontroller through an USB interface chip. Once connection is established and commands are sent, microcontroller takes care of configuring control signals and administering certain levels of automation, such as microstepping generation for (DRV8812/13), STEP and DIR control (for DRV8824/25) or PWM output (for DRV8812/13/14/41/43).

The graphical user interface (GUI) has been designed to allow for all of the DRV88xx device’s functionality to be tested without having to intervene with the hardware, except for the proper configuration of jumpers, when needed.

The following pictures show the CPG004_DRV88xxEVM_R1p1.exe main screen. The application is divided into three tabs: one for each one of the three available device flavors. The menu contains items to configure and enable/disable the serial port.

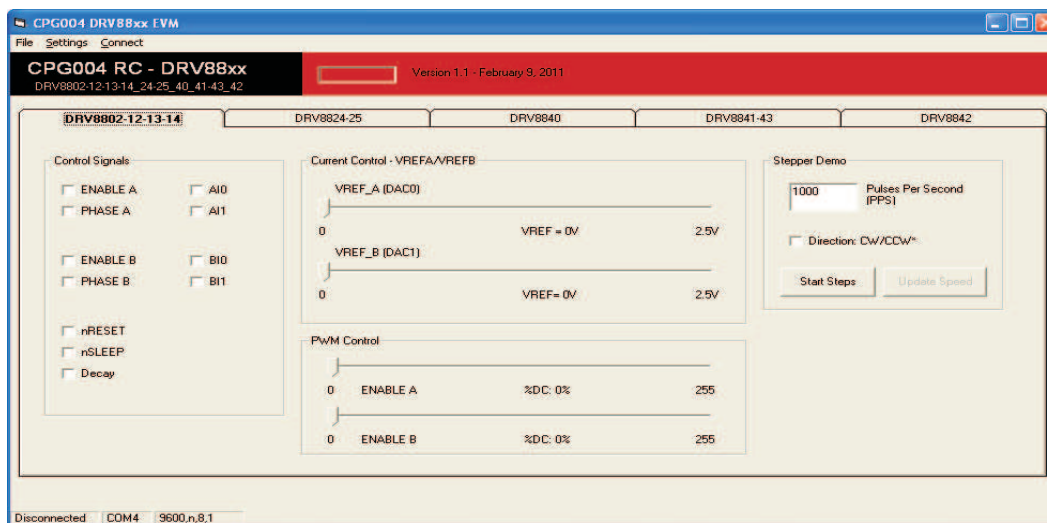

Figure 4. DRV8802-12-13-14 Tab

The DRV8802-12-13-14 tab contains all the control signals needed to control motor enablement (ENABLE A, ENABLE B), direction of rotation (PHASE A, PHASE B) and current control (AIx and BIx). Access to both DAC generating VREF analog voltages is achieved by moving sliders. Another set of sliders allow the control of PWM duty cycle on ENABLE x pins. This is intended for motion control.

A simple stepper demo allows hooking a bipolar stepper to the DRV8812 EVM and have its speed and direction controlled by an algorithm which modulates the VREF current in a high resolution microstepping style. This function is achieved by using both MSP430 DAC outputs and is only available if respective jumpers are set for dual DAC connection (as default).

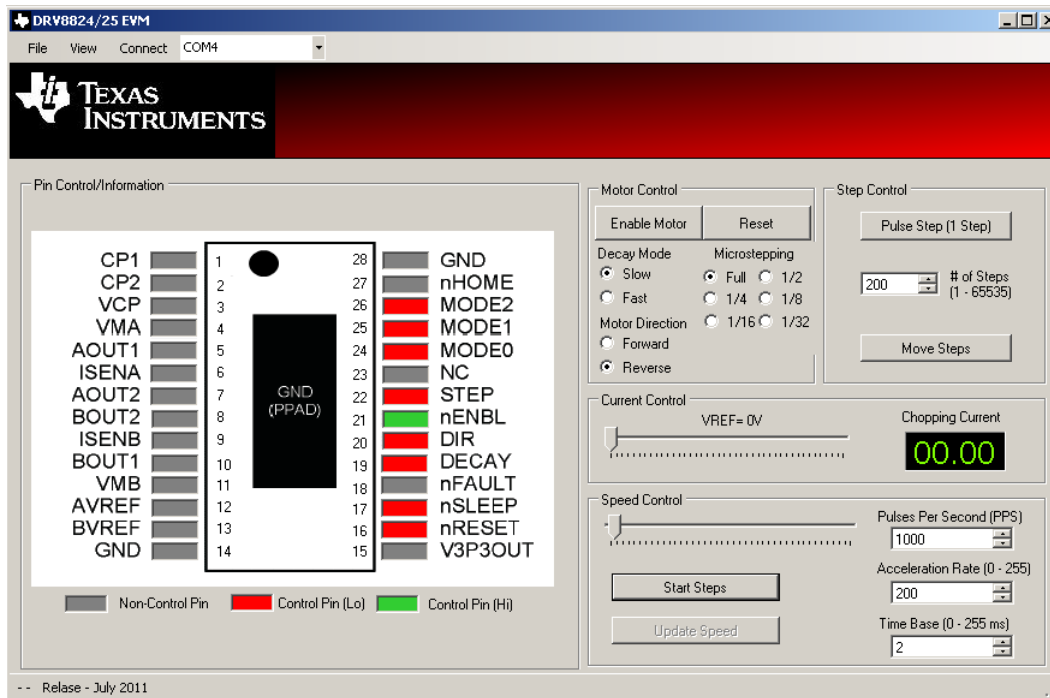

Figure 5. DRV8824-25 GUI

The DRV8824-25 has an updated GUI that contains all the necessary control signals for driving a bipolar stepper. Important aspects to control are enablement, direction of rotation, speed, number of steps, reference voltage (for maximum current) and degrees of microstepping.

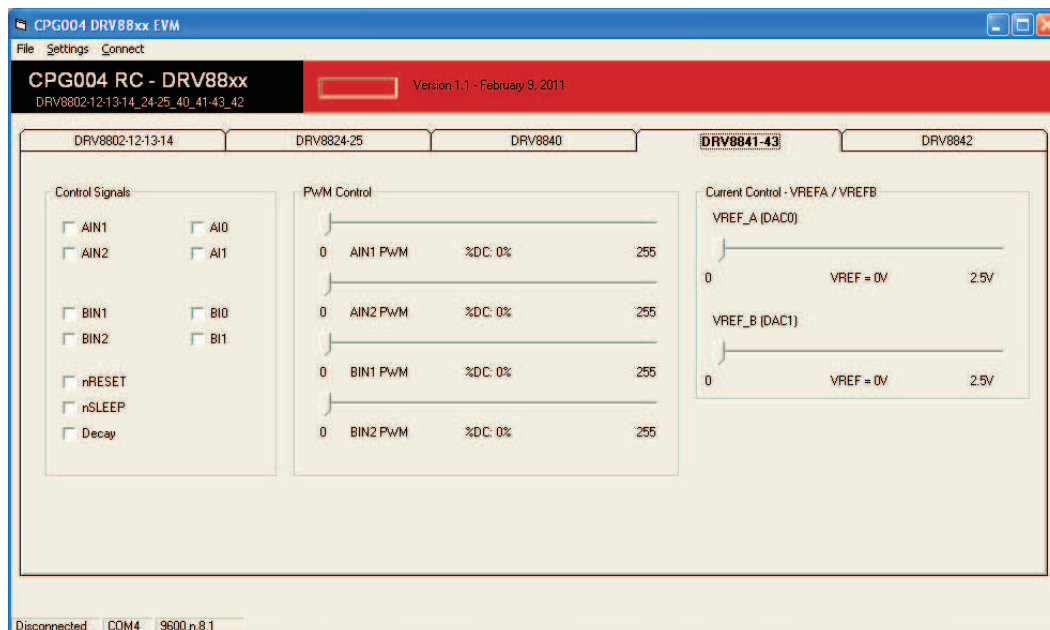

Figure 6. DRV8841-43 Tab

The DRV8841-43 tab is very similar to the DRV8802-12-13-14 tab, except correct naming conventions have been followed to showcase the AINx pins (instead of PHASE and ENABLE). In this tab, the four INx signals have a respective PWM slider in order to provide speed control per H Bridge on both directions per H Bridge.

3.1 The Menu

The menu at the top of the application offers a series of quick options for how the COM port is to behave.

File: Exit – Terminates the application

Settings: Port – Selects from COM1 to COM4. Default is COM4.

The serial port's actual port number defaults to what we have specified on the "USB_Drivers_Install_Readme.pdf". However, any port between COM 1 and COM 4 are equally usable.

Connect: Opens the serial port. When this menu item is pressed, its caption changes to "Disconnect".

Disconnect: Closes the serial port. When this menu item is pressed, its caption changes to "Connect".

After opening the application, the order of events should be:

1. Go to Settings → Port and choose the COM Port where the FTDI device has been configured to work. If the COM port is 4, then this step can be skipped, as application defaults to COM4.
2. Press Connect. If the port is available, the menu changes the "Connect" caption to "Disconnect". Press Disconnect to disable the serial communications.
3. <1><0><0> should return on the text box as an acknowledge. The text box also changes from red to green.
4. The application is ready for use.

3.2 DRV88xx GPIO Control Signals

Once the application is communicating with the interface board, the control signals can be actuated by checking or un-checking check boxes on the Signals frame. Each tab will have a different set of control signals as depending on the device being interface on. nSLEEP and nRESET control signals will be on all tabs.

Functionality of control signals is identical across the platform. A checked checkbox translates to a HI level on the respective control signal. Unchecked checkboxes translates to a LO level on the respective control signals.

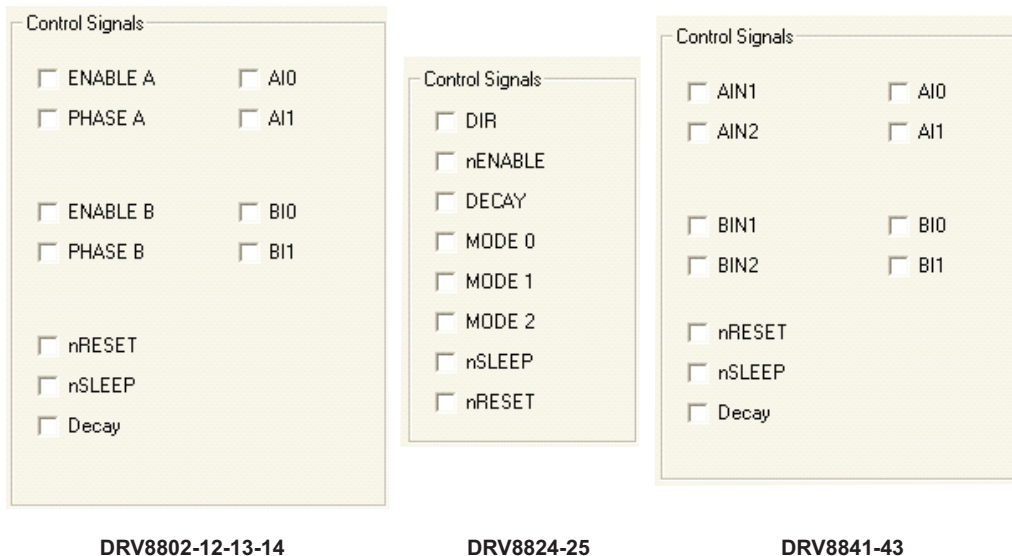

Figure 7. GPIO Control Signals

3.2.1 About DECAY

The DECAY pin is in reality a triple state input. The GPIO operates as HI and LO according to the checkbox. To have the DECAY pin floating, engaging mixed decay mode, simply remove the decay jumper JP3.

3.3 Updating DAC Output for Current Control (VREFA and VREFB)

If the DRV88xx has been configured to accept VREF analog voltages through the microcontroller DAC outputs (refer to Jumpers section), then the slider bar on the Current Control frame can be used to set the VREF voltage.

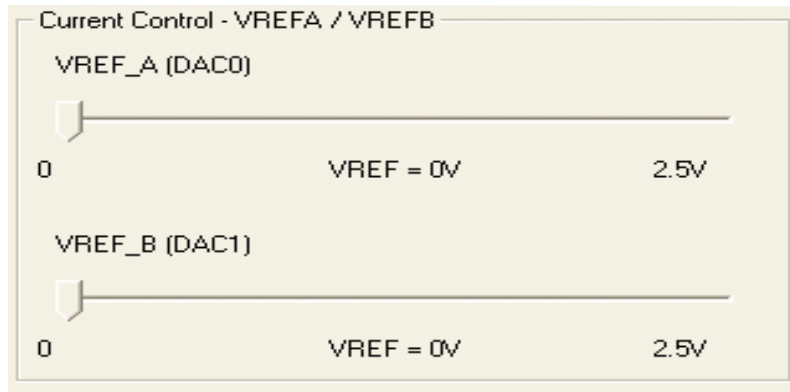

Figure 8. Current Control

The 12-bit DAC channels 0/1 are connected to the DRV88xx VREF analog inputs ABVREF and CDVREF. Changing the DAC digital value from 0 to 4095, changes the analog voltage at the respective VREF pin from 0 V to 2.5 V respectively, following the equation:

$$VREF = DAC_VALUE \cdot \frac{2.5 V}{4095} \tag{1}$$

Where:

VREF is the output voltage.

DAC_VALUE is a number from 0 to 4095.

Moving the sliders will update the “VREF = xV” caption below each respective slider with the result of the previous equation giving the user an idea of what analog voltage is being presented at the reference voltage input.

3.4 DC Motor Speed Control (PWM)

The DRV8802-14 can be utilized to control DC motors. For the purpose to control DC motor speed, a slider is provided which applies a PWM to the ENABLE line. The PWM slider consists of an 8-bit number so position from 0 to 255 are obtained. The MSP430 directly transforms this 8 bit number into the respective duty cycle. PWM frequency is around 31.25 kHz.

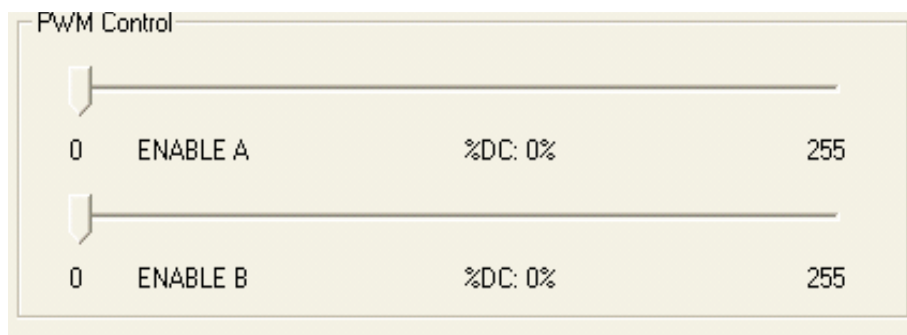

Figure 9. Duty Cycle Indicator

When the slider bar is moved across, the Duty Cycle indicator is updated accordingly. Resulting duty cycle is an integer number between 0 and 100 and it is computed according to the equation:

$$\%Duty\ Cycle = \frac{PWM}{255 \cdot 100} \tag{2}$$

The DRV8841-43 will offer the same ability to apply a PWM signal to each one of the INx pins.

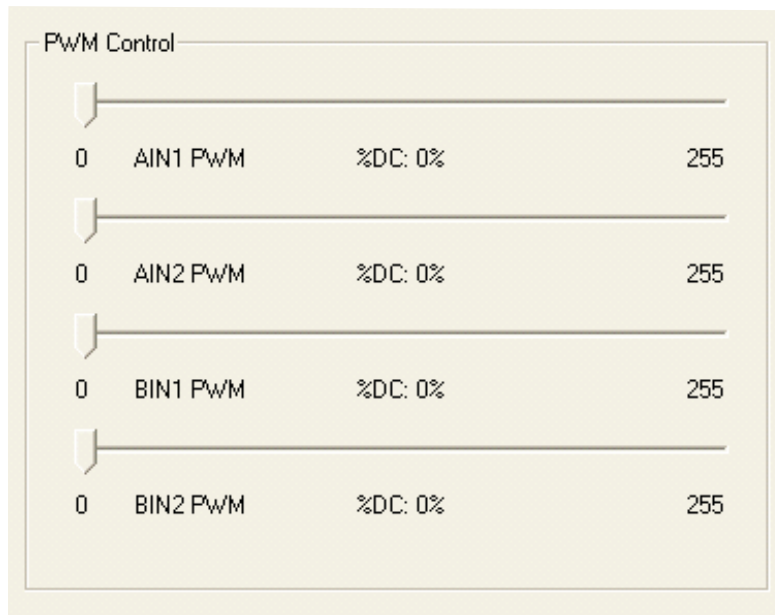

Figure 10. PWM Signal on INx Pins

3.5 Operating the Stepper Motor (DRV8824)

3.5.1 Turning the Stepper Motor

The Windows application, in conjunction with the MSP430F1612 microcontroller, utilizes a series of timers to coordinate the rate of steps sent to the device. Once all the control signals are configured accordingly, (ENABLEn = LO, SLEEPn = HI, RESETn = HI; DIR, USMx can be HI or LO depending on preferred mode of operation), the motor is ready to be turned.

The DRV88xx EVM allows for the possibility of coordinating step rates such that accelerating and decelerating profiles are achieved. Both acceleration and deceleration are controlled by the same parameters, acceleration rate and time base.

When the motor starts, it always starts at the slowed PPS speed (62 pulses per second). The controller will accelerate the motor in order to reach the PPS speed. Acceleration rate is an 8-bit number (0 to 255) that gets added to the current PPS speed and time base is an 8-bit number (0 to 255) that specifies how many milliseconds will elapse from one speed increase to the next. Once the specified PPS speed has been achieved, the acceleration stops.

When the motor stops, the inverse of the above description occurs.

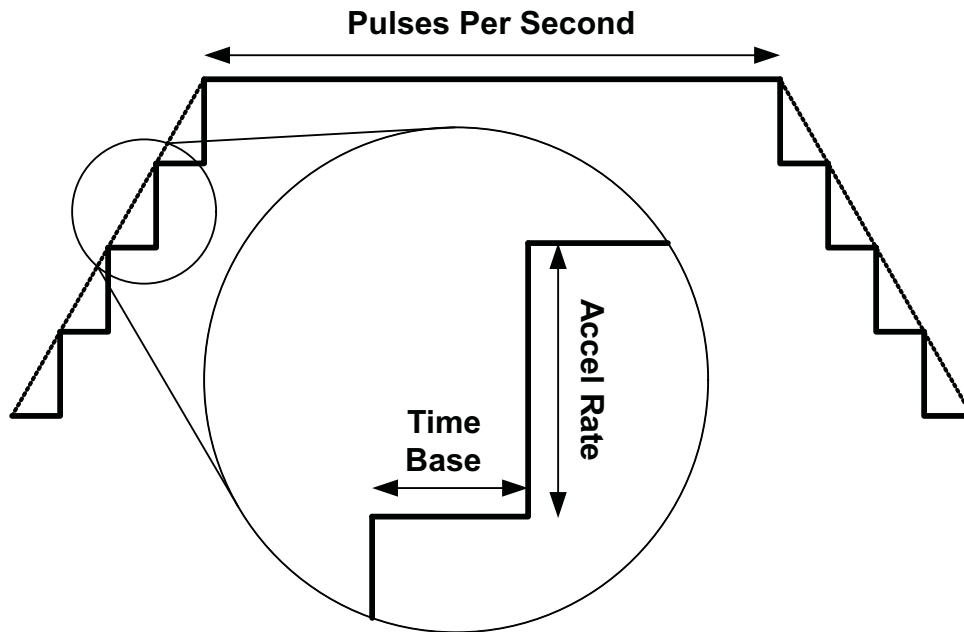

Figure 11. Turning the Stepper Motor

The Windows application frame to control speed, acceleration and deceleration, as well as motor start and stop, is shown in [Figure 12](#).

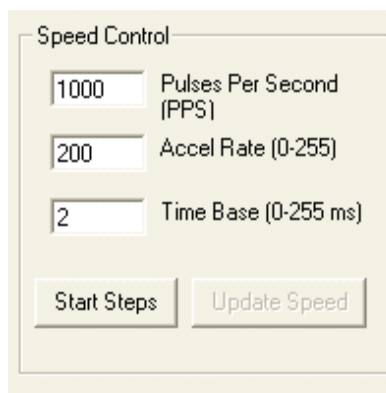

Figure 12. Speed Control

Pressing the “Start Steps” button, will start the timer and pulses will be generated at the rate specified by the decimal number at the PPS text box. Once the “Start Steps” button is pressed it becomes the “Stepping” button. Press the “Stepping” button to stop the stepper motion.

When the motor is stepping, the “Update Speed” button becomes enabled. Speed can be updated by modifying the PPS text box and then pressing the “Update Speed” button. The “Speed Button is disabled every time the motor is not turning because the stepping has been halted by pressing the “Stepping” button.

3.5.2 Step by Step Control

The step control frame has a series of tools to control the stepping of the motor on a predetermined number of steps fashion.

The “Pulse Step” button allows for a single step to be issued. Remember that a STEP takes place when STEP goes from LO to HI.

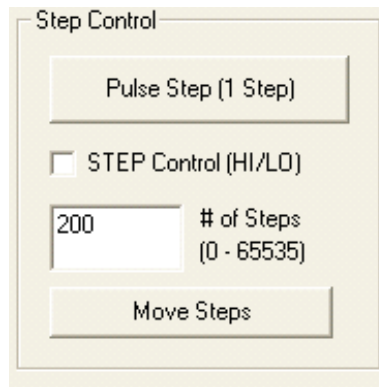

Figure 13. Step Control

To move the motor a number of steps and then stop, fill the # of Steps text box with a decimal number from 0 to 65535 and the motor will move that number of steps at the speed specified on the PPS text box. No acceleration or deceleration takes place under this function.

3.5.3 Stepper Speed Calculator

In order to easily translate steps per second to actual angular velocity, a simple calculator is provided. The calculator extracts step resolution information from the Mode x pins values and STEP frequency from the PPS text box. The user must then provide number of steps per resolution the motor has been manufactured to achieve. For example, a 1.8 degrees stepper motor would have 200 steps per revolution, and so on.

By pressing the Compute button, the calculator reports the revolutions per second and revolutions per minute parameters. For example, on the picture below, the stepping rate was set to 4000 steps per second. While microstepping with 4 degrees of microstepping, a motor with 200 steps per revolution should be moving at 5 revolutions per second or 300 revolutions per minute.

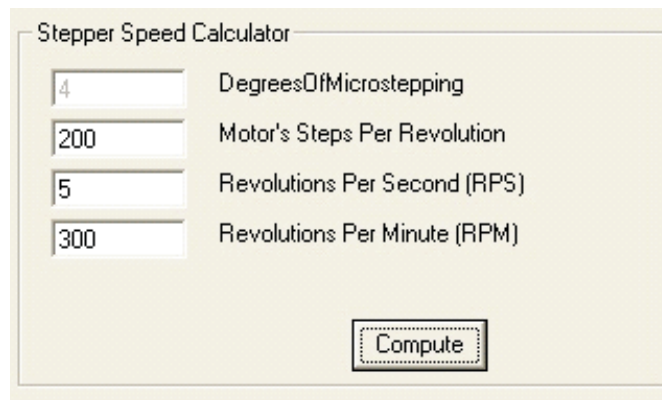
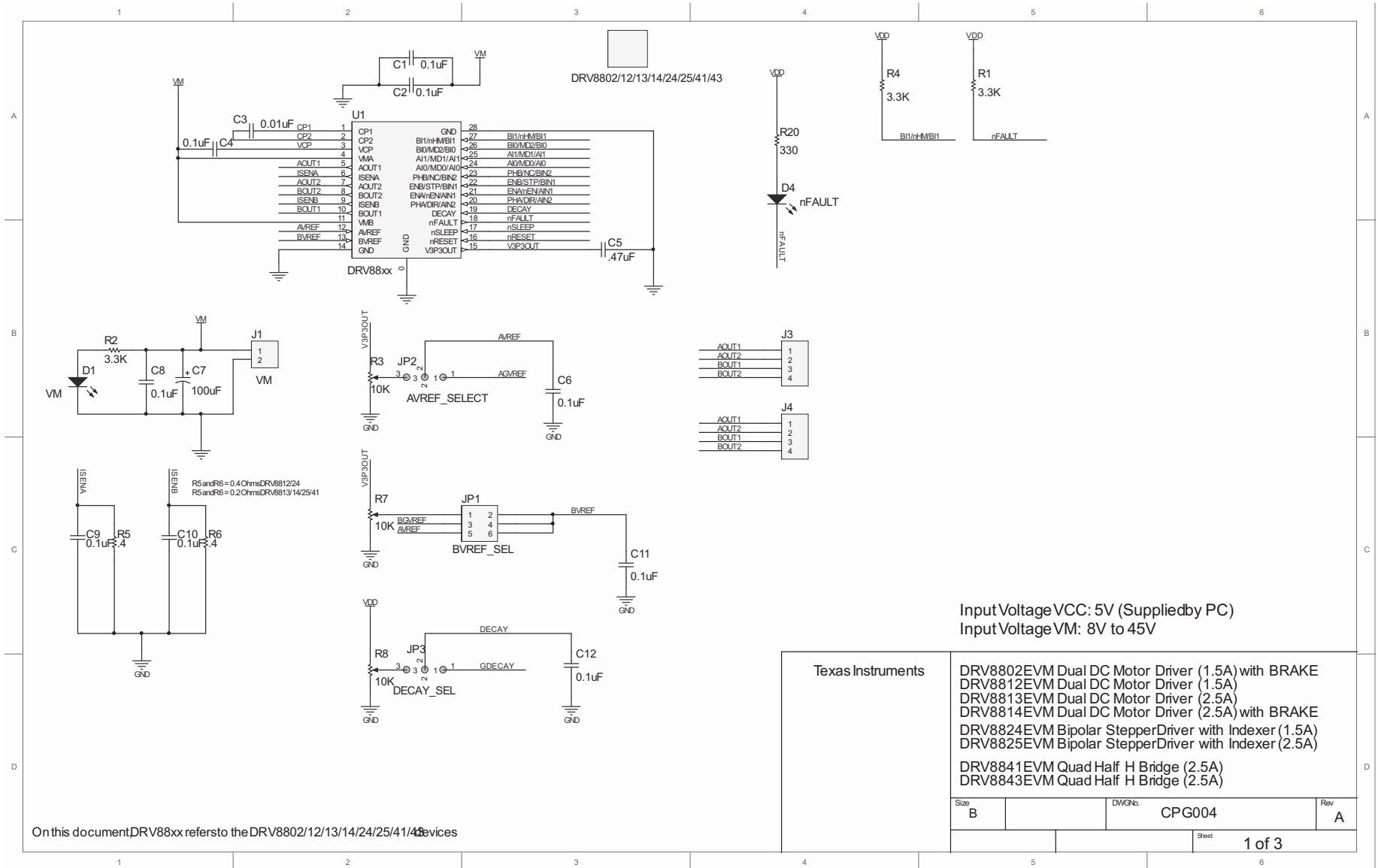
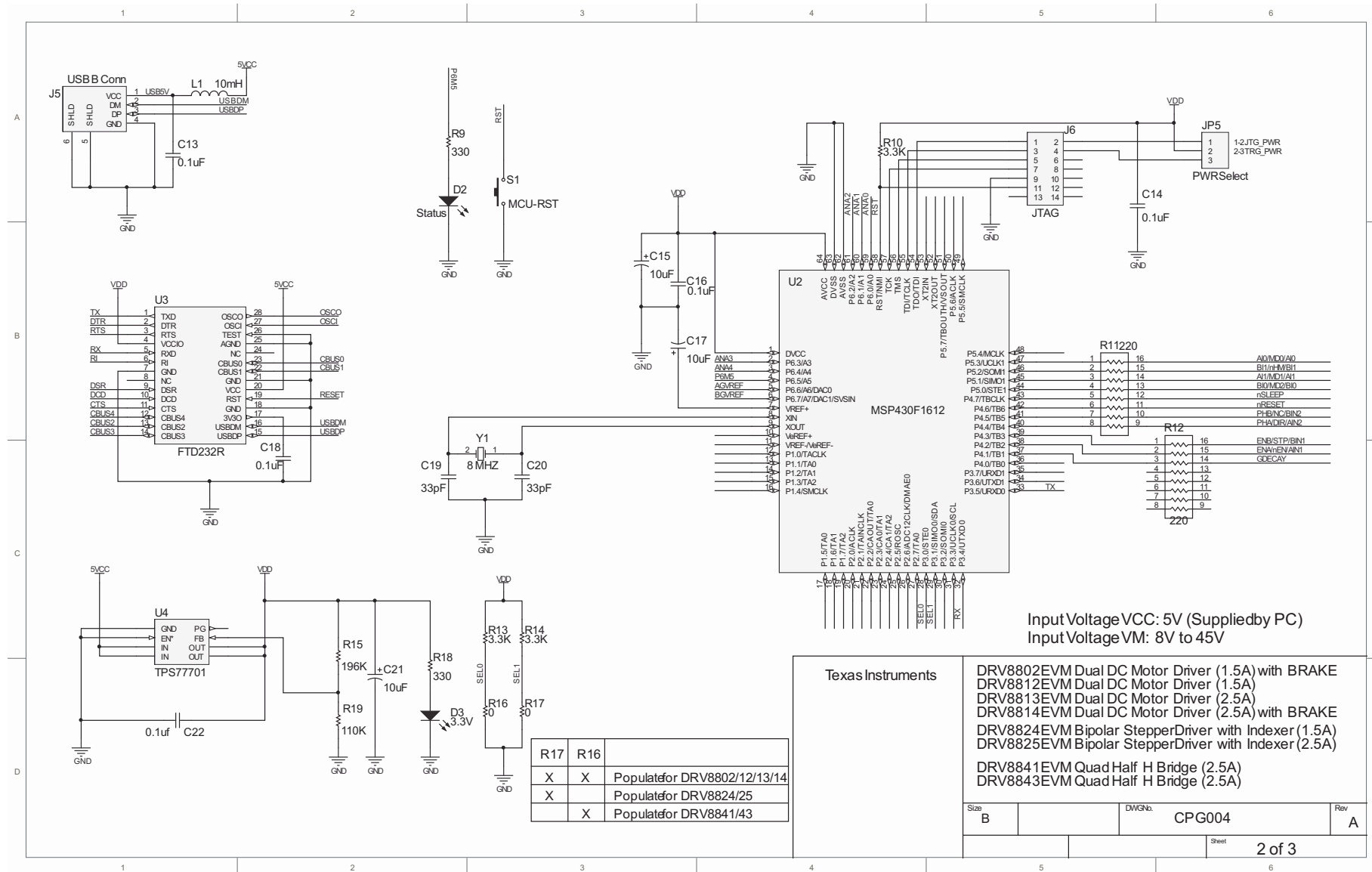

Figure 14. Stepper Speed Calculator

4 Schematics

See the following pages for schematics.





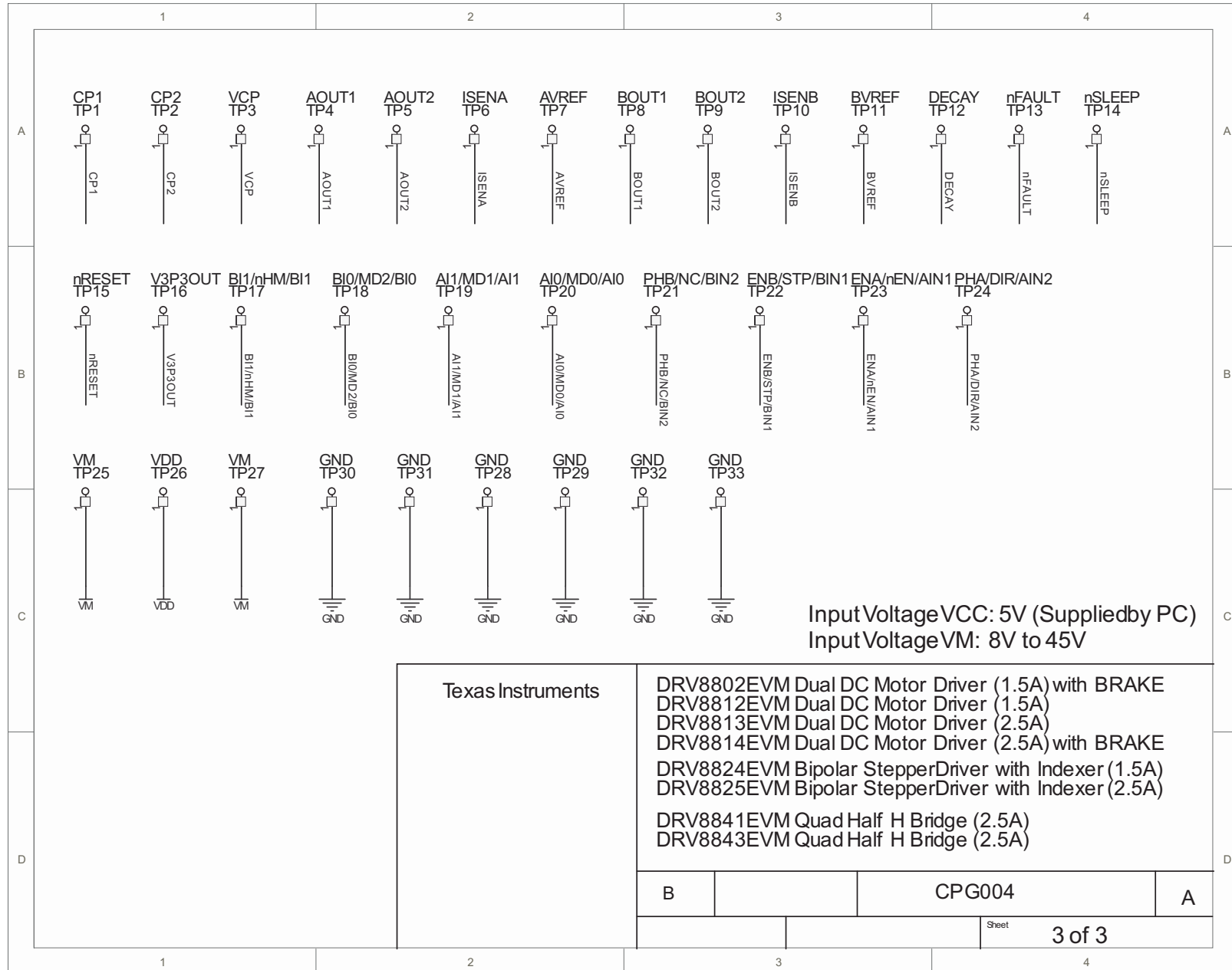

Revision History

Changes from A Revision (June, 2011) to B Revision	Page
• Changed figure 5 and supporting text below image	6

NOTE: Page numbers for previous revisions may differ from page numbers in the current version.

EVALUATION BOARD/KIT/MODULE (EVM) ADDITIONAL TERMS

Texas Instruments (TI) provides the enclosed Evaluation Board/Kit/Module (EVM) under the following conditions:

The user assumes all responsibility and liability for proper and safe handling of the goods. Further, the user indemnifies TI from all claims arising from the handling or use of the goods.

Should this evaluation board/kit not meet the specifications indicated in the User's Guide, the board/kit may be returned within 30 days from the date of delivery for a full refund. THE FOREGOING LIMITED WARRANTY IS THE EXCLUSIVE WARRANTY MADE BY SELLER TO BUYER AND IS IN LIEU OF ALL OTHER WARRANTIES, EXPRESSED, IMPLIED, OR STATUTORY, INCLUDING ANY WARRANTY OF MERCHANTABILITY OR FITNESS FOR ANY PARTICULAR PURPOSE. EXCEPT TO THE EXTENT OF THE INDEMNITY SET FORTH ABOVE, NEITHER PARTY SHALL BE LIABLE TO THE OTHER FOR ANY INDIRECT, SPECIAL, INCIDENTAL, OR CONSEQUENTIAL DAMAGES.

Please read the User's Guide and, specifically, the Warnings and Restrictions notice in the User's Guide prior to handling the product. This notice contains important safety information about temperatures and voltages. For additional information on TI's environmental and/or safety programs, please visit www.ti.com/esh or contact TI.

No license is granted under any patent right or other intellectual property right of TI covering or relating to any machine, process, or combination in which such TI products or services might be or are used. TI currently deals with a variety of customers for products, and therefore our arrangement with the user is not exclusive. TI assumes no liability for applications assistance, customer product design, software performance, or infringement of patents or services described herein.

REGULATORY COMPLIANCE INFORMATION

As noted in the EVM User's Guide and/or EVM itself, this EVM and/or accompanying hardware may or may not be subject to the Federal Communications Commission (FCC) and Industry Canada (IC) rules.

For EVMs **not** subject to the above rules, this evaluation board/kit/module is intended for use for ENGINEERING DEVELOPMENT, DEMONSTRATION OR EVALUATION PURPOSES ONLY and is not considered by TI to be a finished end product fit for general consumer use. It generates, uses, and can radiate radio frequency energy and has not been tested for compliance with the limits of computing devices pursuant to part 15 of FCC or ICES-003 rules, which are designed to provide reasonable protection against radio frequency interference. Operation of the equipment may cause interference with radio communications, in which case the user at his own expense will be required to take whatever measures may be required to correct this interference.

General Statement for EVMs including a radio

User Power/Frequency Use Obligations: This radio is intended for development/professional use only in legally allocated frequency and power limits. Any use of radio frequencies and/or power availability of this EVM and its development application(s) must comply with local laws governing radio spectrum allocation and power limits for this evaluation module. It is the user's sole responsibility to only operate this radio in legally acceptable frequency space and within legally mandated power limitations. Any exceptions to this are strictly prohibited and unauthorized by Texas Instruments unless user has obtained appropriate experimental/development licenses from local regulatory authorities, which is responsibility of user including its acceptable authorization.

For EVMs annotated as FCC – FEDERAL COMMUNICATIONS COMMISSION Part 15 Compliant

Caution

This device complies with part 15 of the FCC Rules. Operation is subject to the following two conditions: (1) This device may not cause harmful interference, and (2) this device must accept any interference received, including interference that may cause undesired operation.

Changes or modifications not expressly approved by the party responsible for compliance could void the user's authority to operate the equipment.

FCC Interference Statement for Class A EVM devices

This equipment has been tested and found to comply with the limits for a Class A digital device, pursuant to part 15 of the FCC Rules. These limits are designed to provide reasonable protection against harmful interference when the equipment is operated in a commercial environment. This equipment generates, uses, and can radiate radio frequency energy and, if not installed and used in accordance with the instruction manual, may cause harmful interference to radio communications. Operation of this equipment in a residential area is likely to cause harmful interference in which case the user will be required to correct the interference at his own expense.

FCC Interference Statement for Class B EVM devices

This equipment has been tested and found to comply with the limits for a Class B digital device, pursuant to part 15 of the FCC Rules. These limits are designed to provide reasonable protection against harmful interference in a residential installation. This equipment generates, uses and can radiate radio frequency energy and, if not installed and used in accordance with the instructions, may cause harmful interference to radio communications. However, there is no guarantee that interference will not occur in a particular installation. If this equipment does cause harmful interference to radio or television reception, which can be determined by turning the equipment off and on, the user is encouraged to try to correct the interference by one or more of the following measures:

- Reorient or relocate the receiving antenna.
- Increase the separation between the equipment and receiver.
- Connect the equipment into an outlet on a circuit different from that to which the receiver is connected.
- Consult the dealer or an experienced radio/TV technician for help.

For EVMs annotated as IC – INDUSTRY CANADA Compliant

This Class A or B digital apparatus complies with Canadian ICES-003.

Changes or modifications not expressly approved by the party responsible for compliance could void the user's authority to operate the equipment.

Concerning EVMs including radio transmitters

This device complies with Industry Canada licence-exempt RSS standard(s). Operation is subject to the following two conditions: (1) this device may not cause interference, and (2) this device must accept any interference, including interference that may cause undesired operation of the device.

Concerning EVMs including detachable antennas

Under Industry Canada regulations, this radio transmitter may only operate using an antenna of a type and maximum (or lesser) gain approved for the transmitter by Industry Canada. To reduce potential radio interference to other users, the antenna type and its gain should be so chosen that the equivalent isotropically radiated power (e.i.r.p.) is not more than that necessary for successful communication.

This radio transmitter has been approved by Industry Canada to operate with the antenna types listed in the user guide with the maximum permissible gain and required antenna impedance for each antenna type indicated. Antenna types not included in this list, having a gain greater than the maximum gain indicated for that type, are strictly prohibited for use with this device.

Cet appareil numérique de la classe A ou B est conforme à la norme NMB-003 du Canada.

Les changements ou les modifications pas expressément approuvés par la partie responsable de la conformité ont pu vider l'autorité de l'utilisateur pour actionner l'équipement.

Concernant les EVMs avec appareils radio

Le présent appareil est conforme aux CNR d'Industrie Canada applicables aux appareils radio exempts de licence. L'exploitation est autorisée aux deux conditions suivantes : (1) l'appareil ne doit pas produire de brouillage, et (2) l'utilisateur de l'appareil doit accepter tout brouillage radioélectrique subi, même si le brouillage est susceptible d'en compromettre le fonctionnement.

Concernant les EVMs avec antennes détachables

Conformément à la réglementation d'Industrie Canada, le présent émetteur radio peut fonctionner avec une antenne d'un type et d'un gain maximal (ou inférieur) approuvé pour l'émetteur par Industrie Canada. Dans le but de réduire les risques de brouillage radioélectrique à l'intention des autres utilisateurs, il faut choisir le type d'antenne et son gain de sorte que la puissance isotrope rayonnée équivalente (p.i.r.e.) ne dépasse pas l'intensité nécessaire à l'établissement d'une communication satisfaisante.

Le présent émetteur radio a été approuvé par Industrie Canada pour fonctionner avec les types d'antenne énumérés dans le manuel d'usage et ayant un gain admissible maximal et l'impédance requise pour chaque type d'antenne. Les types d'antenne non inclus dans cette liste, ou dont le gain est supérieur au gain maximal indiqué, sont strictement interdits pour l'exploitation de l'émetteur.

【Important Notice for Users of EVMs for RF Products in Japan】

This development kit is NOT certified as Confirming to Technical Regulations of Radio Law of Japan

If you use this product in Japan, you are required by Radio Law of Japan to follow the instructions below with respect to this product:

1. Use this product in a shielded room or any other test facility as defined in the notification #173 issued by Ministry of Internal Affairs and Communications on March 28, 2006, based on Sub-section 1.1 of Article 6 of the Ministry's Rule for Enforcement of Radio Law of Japan,
2. Use this product only after you obtained the license of Test Radio Station as provided in Radio Law of Japan with respect to this product, or
3. Use of this product only after you obtained the Technical Regulations Conformity Certification as provided in Radio Law of Japan with respect to this product. Also, please do not transfer this product, unless you give the same notice above to the transferee. Please note that if you could not follow the instructions above, you will be subject to penalties of Radio Law of Japan.

Texas Instruments Japan Limited
(address) 24-1, Nishi-Shinjuku 6 chome, Shinjuku-ku, Tokyo, Japan

<http://www.tij.co.jp>

【無線電波を送信する製品の開発キットをお使いになる際の注意事項】

本開発キットは技術基準適合証明を受けておりません。

本製品のご使用に際しては、電波法遵守のため、以下のいずれかの措置を取っていただく必要がありますのでご注意ください。

1. 電波法施行規則第6条第1項第1号に基づく平成18年3月28日総務省告示第173号で定められた電波暗室等の試験設備でご使用いただく。
2. 実験局の免許を取得後ご使用いただく。
3. 技術基準適合証明を取得後ご使用いただく。

なお、本製品は、上記の「ご使用にあたっての注意」を譲渡先、移転先に通知しない限り、譲渡、移転できないものとします。

上記を遵守頂けない場合は、電波法の罰則が適用される可能性があることをご留意ください。

日本テキサス・インスツルメンツ株式会社
東京都新宿区西新宿6丁目24番1号
西新宿三井ビル

<http://www.tij.co.jp>

EVALUATION BOARD/KIT/MODULE (EVM) WARNINGS, RESTRICTIONS AND DISCLAIMERS

For Feasibility Evaluation Only, in Laboratory/Development Environments. Unless otherwise indicated, this EVM is not a finished electrical equipment and not intended for consumer use. It is intended solely for use for preliminary feasibility evaluation in laboratory/development environments by technically qualified electronics experts who are familiar with the dangers and application risks associated with handling electrical mechanical components, systems and subsystems. It should not be used as all or part of a finished end product.

Your Sole Responsibility and Risk. You acknowledge, represent and agree that:

1. You have unique knowledge concerning Federal, State and local regulatory requirements (including but not limited to Food and Drug Administration regulations, if applicable) which relate to your products and which relate to your use (and/or that of your employees, affiliates, contractors or designees) of the EVM for evaluation, testing and other purposes.
2. You have full and exclusive responsibility to assure the safety and compliance of your products with all such laws and other applicable regulatory requirements, and also to assure the safety of any activities to be conducted by you and/or your employees, affiliates, contractors or designees, using the EVM. Further, you are responsible to assure that any interfaces (electronic and/or mechanical) between the EVM and any human body are designed with suitable isolation and means to safely limit accessible leakage currents to minimize the risk of electrical shock hazard.
3. Since the EVM is not a completed product, it may not meet all applicable regulatory and safety compliance standards (such as UL, CSA, VDE, CE, RoHS and WEEE) which may normally be associated with similar items. You assume full responsibility to determine and/or assure compliance with any such standards and related certifications as may be applicable. You will employ reasonable safeguards to ensure that your use of the EVM will not result in any property damage, injury or death, even if the EVM should fail to perform as described or expected.
4. You will take care of proper disposal and recycling of the EVM's electronic components and packing materials.

Certain Instructions. It is important to operate this EVM within TI's recommended specifications and environmental considerations per the user guidelines. Exceeding the specified EVM ratings (including but not limited to input and output voltage, current, power, and environmental ranges) may cause property damage, personal injury or death. If there are questions concerning these ratings please contact a TI field representative prior to connecting interface electronics including input power and intended loads. Any loads applied outside of the specified output range may result in unintended and/or inaccurate operation and/or possible permanent damage to the EVM and/or interface electronics. Please consult the EVM User's Guide prior to connecting any load to the EVM output. If there is uncertainty as to the load specification, please contact a TI field representative. During normal operation, some circuit components may have case temperatures greater than 60°C as long as the input and output are maintained at a normal ambient operating temperature. These components include but are not limited to linear regulators, switching transistors, pass transistors, and current sense resistors which can be identified using the EVM schematic located in the EVM User's Guide. When placing measurement probes near these devices during normal operation, please be aware that these devices may be very warm to the touch. As with all electronic evaluation tools, only qualified personnel knowledgeable in electronic measurement and diagnostics normally found in development environments should use these EVMs.

Agreement to Defend, Indemnify and Hold Harmless. You agree to defend, indemnify and hold TI, its licensors and their representatives harmless from and against any and all claims, damages, losses, expenses, costs and liabilities (collectively, "Claims") arising out of or in connection with any use of the EVM that is not in accordance with the terms of the agreement. This obligation shall apply whether Claims arise under law of tort or contract or any other legal theory, and even if the EVM fails to perform as described or expected.

Safety-Critical or Life-Critical Applications. If you intend to evaluate the components for possible use in safety critical applications (such as life support) where a failure of the TI product would reasonably be expected to cause severe personal injury or death, such as devices which are classified as FDA Class III or similar classification, then you must specifically notify TI of such intent and enter into a separate Assurance and Indemnity Agreement.

IMPORTANT NOTICE FOR TI REFERENCE DESIGNS

Texas Instruments Incorporated ("TI") reference designs are solely intended to assist designers ("Buyers") who are developing systems that incorporate TI semiconductor products (also referred to herein as "components"). Buyer understands and agrees that Buyer remains responsible for using its independent analysis, evaluation and judgment in designing Buyer's systems and products.

TI reference designs have been created using standard laboratory conditions and engineering practices. **TI has not conducted any testing other than that specifically described in the published documentation for a particular reference design.** TI may make corrections, enhancements, improvements and other changes to its reference designs.

Buyers are authorized to use TI reference designs with the TI component(s) identified in each particular reference design and to modify the reference design in the development of their end products. HOWEVER, NO OTHER LICENSE, EXPRESS OR IMPLIED, BY ESTOPPEL OR OTHERWISE TO ANY OTHER TI INTELLECTUAL PROPERTY RIGHT, AND NO LICENSE TO ANY THIRD PARTY TECHNOLOGY OR INTELLECTUAL PROPERTY RIGHT, IS GRANTED HEREIN, including but not limited to any patent right, copyright, mask work right, or other intellectual property right relating to any combination, machine, or process in which TI components or services are used. Information published by TI regarding third-party products or services does not constitute a license to use such products or services, or a warranty or endorsement thereof. Use of such information may require a license from a third party under the patents or other intellectual property of the third party, or a license from TI under the patents or other intellectual property of TI.

TI REFERENCE DESIGNS ARE PROVIDED "AS IS". TI MAKES NO WARRANTIES OR REPRESENTATIONS WITH REGARD TO THE REFERENCE DESIGNS OR USE OF THE REFERENCE DESIGNS, EXPRESS, IMPLIED OR STATUTORY, INCLUDING ACCURACY OR COMPLETENESS. TI DISCLAIMS ANY WARRANTY OF TITLE AND ANY IMPLIED WARRANTIES OF MERCHANTABILITY, FITNESS FOR A PARTICULAR PURPOSE, QUIET ENJOYMENT, QUIET POSSESSION, AND NON-INFRINGEMENT OF ANY THIRD PARTY INTELLECTUAL PROPERTY RIGHTS WITH REGARD TO TI REFERENCE DESIGNS OR USE THEREOF. TI SHALL NOT BE LIABLE FOR AND SHALL NOT DEFEND OR INDEMNIFY BUYERS AGAINST ANY THIRD PARTY INFRINGEMENT CLAIM THAT RELATES TO OR IS BASED ON A COMBINATION OF COMPONENTS PROVIDED IN A TI REFERENCE DESIGN. IN NO EVENT SHALL TI BE LIABLE FOR ANY ACTUAL, SPECIAL, INCIDENTAL, CONSEQUENTIAL OR INDIRECT DAMAGES, HOWEVER CAUSED, ON ANY THEORY OF LIABILITY AND WHETHER OR NOT TI HAS BEEN ADVISED OF THE POSSIBILITY OF SUCH DAMAGES, ARISING IN ANY WAY OUT OF TI REFERENCE DESIGNS OR BUYER'S USE OF TI REFERENCE DESIGNS.

TI reserves the right to make corrections, enhancements, improvements and other changes to its semiconductor products and services per JESD46, latest issue, and to discontinue any product or service per JESD48, latest issue. Buyers should obtain the latest relevant information before placing orders and should verify that such information is current and complete. All semiconductor products are sold subject to TI's terms and conditions of sale supplied at the time of order acknowledgment.

TI warrants performance of its components to the specifications applicable at the time of sale, in accordance with the warranty in TI's terms and conditions of sale of semiconductor products. Testing and other quality control techniques for TI components are used to the extent TI deems necessary to support this warranty. Except where mandated by applicable law, testing of all parameters of each component is not necessarily performed.

TI assumes no liability for applications assistance or the design of Buyers' products. Buyers are responsible for their products and applications using TI components. To minimize the risks associated with Buyers' products and applications, Buyers should provide adequate design and operating safeguards.

Reproduction of significant portions of TI information in TI data books, data sheets or reference designs is permissible only if reproduction is without alteration and is accompanied by all associated warranties, conditions, limitations, and notices. TI is not responsible or liable for such altered documentation. Information of third parties may be subject to additional restrictions.

Buyer acknowledges and agrees that it is solely responsible for compliance with all legal, regulatory and safety-related requirements concerning its products, and any use of TI components in its applications, notwithstanding any applications-related information or support that may be provided by TI. Buyer represents and agrees that it has all the necessary expertise to create and implement safeguards that anticipate dangerous failures, monitor failures and their consequences, lessen the likelihood of dangerous failures and take appropriate remedial actions. Buyer will fully indemnify TI and its representatives against any damages arising out of the use of any TI components in Buyer's safety-critical applications.

In some cases, TI components may be promoted specifically to facilitate safety-related applications. With such components, TI's goal is to help enable customers to design and create their own end-product solutions that meet applicable functional safety standards and requirements. Nonetheless, such components are subject to these terms.

No TI components are authorized for use in FDA Class III (or similar life-critical medical equipment) unless authorized officers of the parties have executed an agreement specifically governing such use.

Only those TI components that TI has specifically designated as military grade or "enhanced plastic" are designed and intended for use in military/aerospace applications or environments. Buyer acknowledges and agrees that any military or aerospace use of TI components that have **not** been so designated is solely at Buyer's risk, and Buyer is solely responsible for compliance with all legal and regulatory requirements in connection with such use.

TI has specifically designated certain components as meeting ISO/TS16949 requirements, mainly for automotive use. In any case of use of non-designated products, TI will not be responsible for any failure to meet ISO/TS16949.



Стандарт Электрон Связь

Мы молодая и активно развивающаяся компания в области поставок электронных компонентов. Мы поставляем электронные компоненты отечественного и импортного производства напрямую от производителей и с крупнейших складов мира.

Благодаря сотрудничеству с мировыми поставщиками мы осуществляем комплексные и плановые поставки широчайшего спектра электронных компонентов.

Собственная эффективная логистика и склад в обеспечивает надежную поставку продукции в точно указанные сроки по всей России.

Мы осуществляем техническую поддержку нашим клиентам и предпродажную проверку качества продукции. На все поставляемые продукты мы предоставляем гарантию .

Осуществляем поставки продукции под контролем ВП МО РФ на предприятия военно-промышленного комплекса России , а также работаем в рамках 275 ФЗ с открытием отдельных счетов в уполномоченном банке. Система менеджмента качества компании соответствует требованиям ГОСТ ISO 9001.

Минимальные сроки поставки, гибкие цены, неограниченный ассортимент и индивидуальный подход к клиентам являются основой для выстраивания долгосрочного и эффективного сотрудничества с предприятиями радиоэлектронной промышленности, предприятиями ВПК и научно-исследовательскими институтами России.

С нами вы становитесь еще успешнее!

Наши контакты:

Телефон: +7 812 627 14 35

Электронная почта: sales@st-electron.ru

Адрес: 198099, Санкт-Петербург,
Промышленная ул, дом № 19, литера Н,
помещение 100-Н Офис 331