

# Analog Devices Welcomes Hittite Microwave Corporation

NO CONTENT ON THE ATTACHED DOCUMENT HAS CHANGED



**THIS PAGE INTENTIONALLY LEFT BLANK**



### Features

- RF Bandwidth: 990 to 1105 MHz
- Ultra Low Phase Noise  
-110 dBc/Hz in Band Typ.
- Figure of Merit (FOM) -227 dBc
- < 180 fs RMS Jitter
- 24-bit Step Size, Resolution 3 Hz typ
- Exact Frequency Mode
- Built-in Digital Self Test
- 40 Lead 6x6mm SMT Package: 36mm<sup>2</sup>

### Typical Applications

- Cellular/4G Infrastructure
- Repeaters and Femtocells
- Communications Test Equipment
- CATV Equipment
- Phased Array Applications
- DDS Replacement
- Very High Data Rate Radios

### Functional Diagram

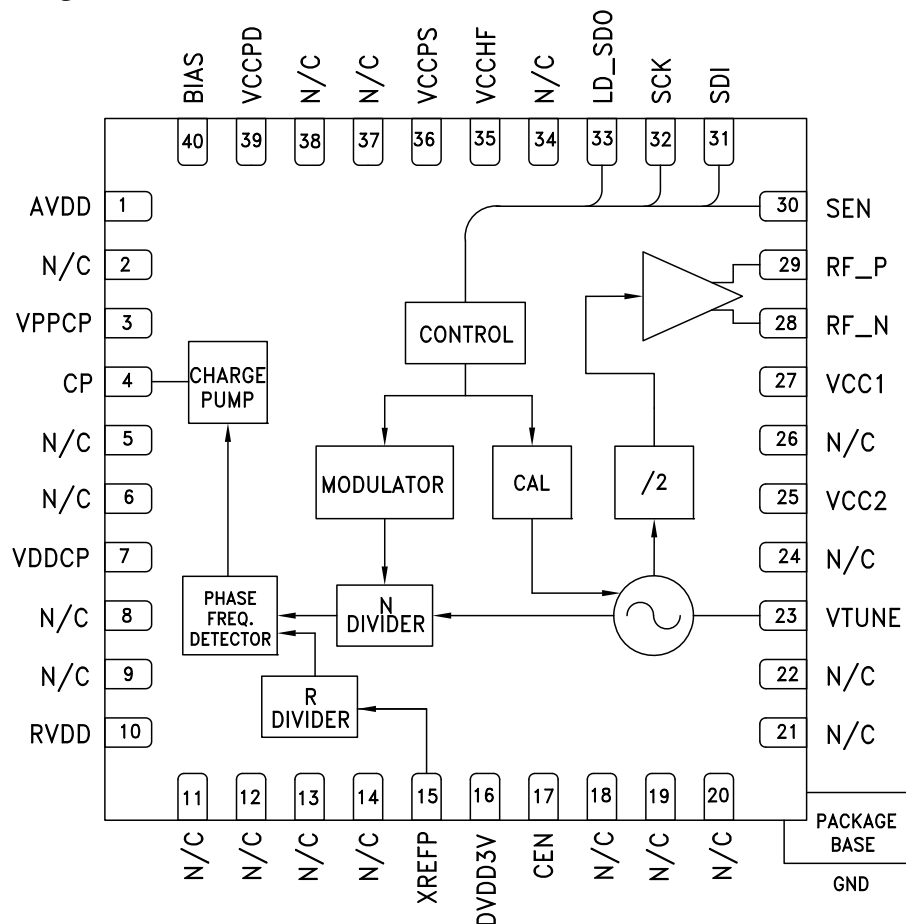



## FRACTIONAL-N SYNTHESIZER WITH INTEGRATED VCO, 990 - 1105 MHz

### General Description

The HMC826LP6CE is a fully functioned Fractional-N Phase-Locked-Loop (PLL) with an Integrated Voltage Controlled Oscillator (VCO). The PLL consists of an integrated low noise VCO with divide-by-2 output, an autocalibration subsystem for low voltage VCO tuning, a very low noise digital Phase Detector (PD), a precision controlled charge pump, a low noise reference path divider and a fractional divider.

The fractional PLL features an advanced delta-sigma modulator design that allows both ultra-fine step sizes and low spurious products. The phase detector (PD) features cycle slip prevention (CSP) technology to allow faster frequency hopping times. Ultra low in-close phase noise and low spurious also allows wider loop bandwidths for faster frequency hopping and low micro-phonics.

For theory of operation and register map refer to the “PLLs with Integrated VCOs - RF VCOs Operating Guide”. To view the Operating Guide, please visit [www.hittite.com](http://www.hittite.com) and choose HMC826LP6CE from the “Search by Part Number” pull down menu.

### Electrical Specifications, $T_A = +25^\circ\text{C}$

**VPPCP, VDDCP, VCC1, VCC2 = 5V ±4%; RVDD, AVDD, DVDD3V, VCCPD, VCCHF, VCCPS = 3.3V ±6% GNDCP = GNDLS = Ground Paddle = 0V**

| Parameter  | Condition  | Min. | Typ. | Max.    | Units |
|--|--|------|------|---------|-------|
| <b>RF Output Characteristics</b>                                       |  |      |      |         |       |
| VCO Frequency at PLL Input   |  | 1980 |      | 2210    | MHz   |
| RF Output Frequency at $f_{VCO}/2$                                     |  | 990  |      | 1105    | MHz   |
| RF Output Power at $f_{VCO}/2$   |  | 8    | 11   | 15      | dBm   |
| VCO Tuning Sensitivity   | Measured at 2 GHz, 2V  |      | 15   |         | MHz/V |
| VCO Supply Pushing   | Measured at 2 GHz, 2V  | -2   |      | 1.5     | MHz/V |
| RF Output 2nd Harmonic   |  |      | -25  |         | dBc   |
| RF Output 3rd Harmonic   |  |      | -23  |         | dBc   |
| RF Output 4th Harmonic   |  |      | -31  |         | dBc   |
| RF Output 5th Harmonic   |  |      | -33  |         | dBc   |
| <b>RF Divider Characteristics</b>                                      |  |      |      |         |       |
| 19-Bit N-Divider Range (Integer)                                       | Max = $2^{19} - 1$   | 16   |      | 524,287 |       |
| 19-Bit N-Divider Range (Fractional)                                    | Fractional nominal divide ratio varies (-3 / +4) dynamically max   | 20   |      | 524,283 |       |
| <b>REF Input Characteristics</b>                                       |  |      |      |         |       |
| Max Ref Input Frequency  | Synthesizer phase noise can degrade by about 5dB when operating with a reference frequency near the low end of this range. | 10   | 50   | 200     | MHz   |
| Ref Input Range  | AC Coupled   | 1.5  | 2    | 3.3     | Vpp   |
| Ref Input Capacitance  |  |      |      | 5       | pF    |
| 14-Bit R-Divider Range   |  | 1    |      | 16,383  |       |
| <b>Phase Detector (PD)</b>   |  |      |      |         |       |
| PD Frequency Fractional Feedback Mode                                  | [1]  | 0.1  |      | 100     | MHz   |
| PD Frequency Fractional Feedforward Mode (and Register 6 [17:16] = 10) |  | 0.1  |      | 80      | MHz   |
| PD Frequency Integer Mode  | [1]  | 0.1  |      | 125     | MHz   |

Note 1: This maximum phase detector frequency can only be achieved if the minimum N value is respected. eg. In the case of fractional feedback mode, the maximum PFD rate =  $f_{vco}/20$  or 100MHz, whichever is less.

**FRACTIONAL-N SYNTHESIZER WITH  
INTEGRATED VCO, 990 - 1105 MHz**
**Electrical Specifications (Continued)**

| Parameter   | Condition                             | Min.       | Typ. | Max.   | Units  |
|---|---------------------------------------|------------|------|--------|--------|
| <b>Charge Pump</b>  |                                       |            |      |        |        |
| Max Output Current  |                                       | 0.02       |      | 2.54   | mA     |
| Charge Pump Gain Step Size (5-Bits)                             |                                       |            | 500  |        | μA     |
| PD/Charge Pump SSB Phase Noise                                  | 50 MHz Ref, Input Referred            |            |      |        |        |
| 1 kHz   |                                       |            | -141 |        | dBc/Hz |
| 10 kHz  | Add 1 dB for Fractional               |            | -149 |        | dBc/Hz |
| 100 kHz   | Add 3 dB for Fractional               |            | -153 |        | dBc/Hz |
| <b>Logic Inputs</b>   |                                       |            |      |        |        |
| VIH Input High Voltage  |                                       | DVDD3V-0.4 |      | DVDD3V | V      |
| VIL Input Low Voltage   |                                       | 0          |      | 0.4    | V      |
| <b>Logic Outputs</b>  |                                       |            |      |        |        |
| VOH Output High Voltage   |                                       | DVDD3V-0.4 |      | DVDD3V | V      |
| VOL Output Low Voltage  |                                       | 0          |      | 0.4    | V      |
| <b>Power Supply Voltages</b>                                    |                                       |            |      |        |        |
| Analog 3.3V Supplies  | AVDD, VCCHF, VCCPS, VCCPD, RVDD       | 3.0        | 3.3  | 3.5    | V      |
| Digital Supply  | DVDD3V                                | 3.0        | 3.3  | 3.5    | V      |
| Analog 5V Supplies  | VPPCP, VDDCP, VCC1, VCC2              | 4.8        | 5    | 5.2    | V      |
| <b>Power Supply Currents</b>                                    |                                       |            |      |        |        |
| +5V Analog Charge Pump  | VPPCP, VDDCP                          |            | 5.3  |        | mA     |
| +5V VCO Core and PLL Buffer                                     | VCC2                                  |            | 56   |        | mA     |
| +5V VCO Divider and RF Buffer                                   | VCC1                                  |            | 36   |        | mA     |
| +3.3V Analog  | AVDD, VCCHF, VCCPS, VCCPD, RVDD       |            | 45   |        | mA     |
| +3.3V Digital   | DVDD3V                                |            | 6.5  |        | mA     |
| Power Down - Crystal Off  | Reg 01h=0,<br>Crystal Not Clocked     |            | 10   |        | μA     |
| Power Down - Crystal On, 100 MHz                                | Reg 01h=0,<br>Crystal Clocked 100 MHz |            | 10   | 200    | μA     |
| <b>Power on Reset</b>   |                                       |            |      |        |        |
| Typical Reset Voltage on DVDD                                   |                                       |            | 700  |        | mV     |
| Min DVDD Voltage for No Reset                                   |                                       | 1.5        |      |        | V      |
| Power on Reset Delay  |                                       |            | 250  |        | μs     |
| <b>VCO Open Loop Phase Noise at <math>fvco/2</math></b>         |                                       |            |      |        |        |
| 1 GHz Divide-by-2 Output  | 10 kHz Offset                         |            | -91  |        | dBc/Hz |
| 1 GHz Divide-by-2 Output  | 100 kHz Offset                        |            | -121 |        | dBc/Hz |
| 1 GHz Divide-by-2 Output  | 1 MHz Offset                          |            | -146 |        | dBc/Hz |
| 1 GHz Divide-by-2 Output  | 10 MHz Offset                         |            | -163 |        | dBc/Hz |
| 1 GHz Divide-by-2 Output  | 100 MHz Offset                        |            | -164 |        | dBc/Hz |
| <b>Closed Loop Phase Noise PLL + VCO at <math>fvco/2</math></b> |                                       |            |      |        |        |
| 1 GHz VCO, Integer, 50 MHz PFD                                  | 1 kHz Offset                          |            | -112 |        | dBc/Hz |
| 1 GHz VCO, Integer, 50 MHz PFD                                  | 10 kHz Offset                         |            | -114 |        | dBc/Hz |
| 1 GHz VCO, Integer, 50 MHz PFD                                  | 100 kHz Offset                        |            | -120 |        | dBc/Hz |
| 1 GHz VCO, Integer, 50 MHz PFD                                  | 1 MHz Offset                          |            | -146 |        | dBc/Hz |



## FRACTIONAL-N SYNTHESIZER WITH INTEGRATED VCO, 990 - 1105 MHz

### Electrical Specifications (Continued)

| Parameter                         | Condition                              | Min. | Typ. | Max. | Units  |
|-----------------------------------|--|------|------|------|--------|
| 1 GHz VCO, Fractional, 50 MHz PFD | 1 kHz Offset                           |      | -107 |      | dBc/Hz |
| 1 GHz VCO, Fractional, 50 MHz PFD | 10 kHz Offset                          |      | -107 |      | dBc/Hz |
| 1 GHz VCO, Fractional, 50 MHz PFD | 100 kHz Offset                         |      | -112 |      | dBc/Hz |
| <b>Figure of Merit</b>            | Normalized 1 Hz                        |      |      |      |        |
| Integer Mode                      | Measured w/ 50 MHz PD at 30 kHz Offset |      | -229 |      | dBc/Hz |
| Fractional Mode                   | Measured w/ 50 MHz PD at 30 kHz Offset |      | -227 |      | dBc/Hz |

#### Closed Loop Integer Phase Noise

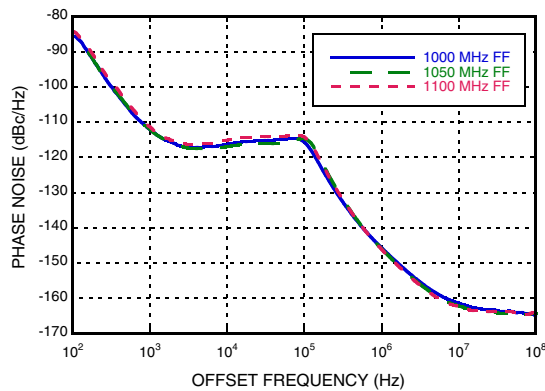

#### Typical Closed Loop Fractional Phase Noise [1]

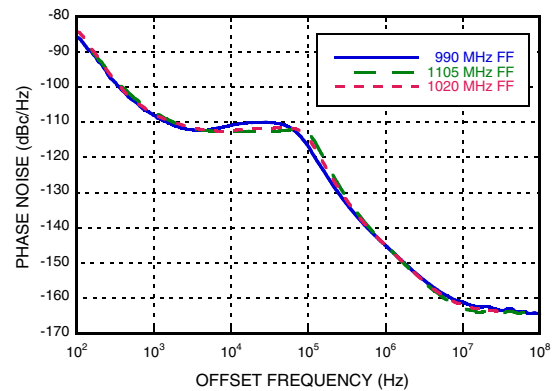

#### VCO/2 Free Running Phase Noise

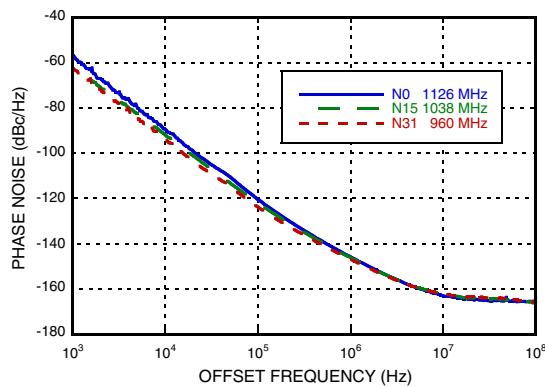

#### Typical VCO/2 Tuning Curves vs. Switch Position

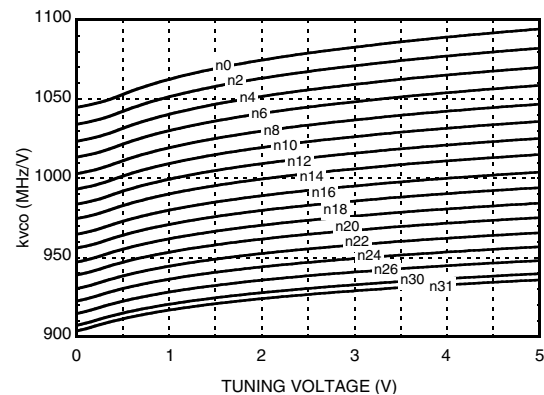

[1] Fractional Mode, 50 MHz Crystal, R=1, ~80 kHz Loop BW, Filter C36 = 560pF, R26 = 680Ω, C35 =15nF, R27 & R28 = 1 kΩ, C37 & C38 = 270 pF, 2mA Charge Pump, -385µA Offset.

## FRACTIONAL-N SYNTHESIZER WITH INTEGRATED VCO, 990 - 1105 MHz

**Free Running VCO Phase Noise**  
( $V_{TUNE}$  Set by AutoCal)

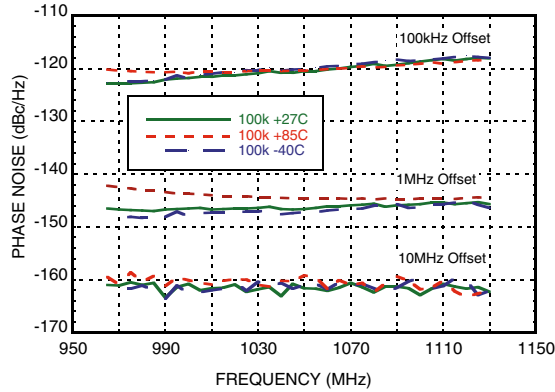

**Typical VCO Tuning Voltage After Calibration**

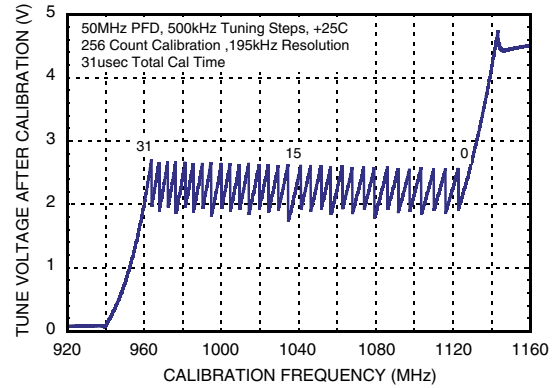

**Typical VCO Sensitivity vs. Cap @ Fo Voltage**

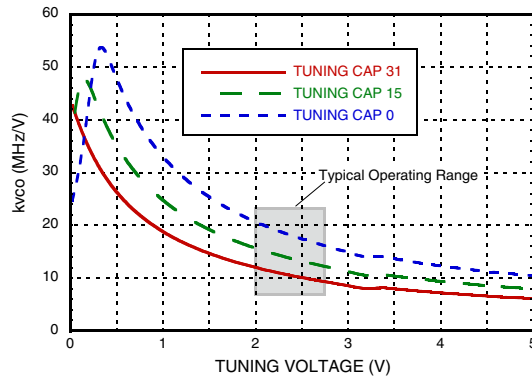

**Typical Spurious at 200 kHz from Integer Boundary [1]**

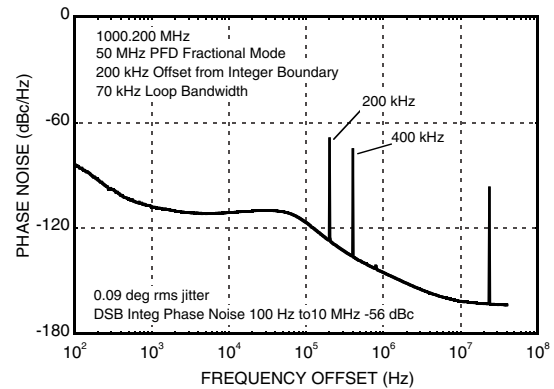

**Typical Output Power - Narrow Band Match**

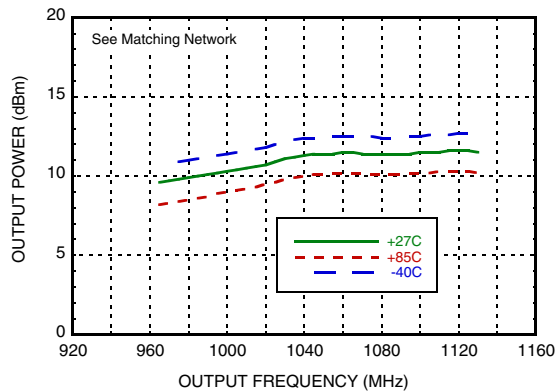

**Figure of Merit**

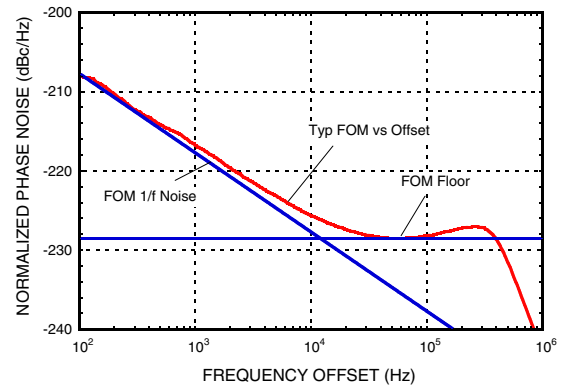

[1] Fractional Mode, 50 MHz Crystal, R=1, ~80 kHz Loop BW. (Loop filter values: C36 = 560pF, R26 = 680Ω, C35 = 15nF, R27 & R28 = 1 kΩ, C37 & C38 = 270 pF) 2mA Charge Pump, -385μA Offset.

**FRACTIONAL-N SYNTHESIZER WITH  
INTEGRATED VCO, 990 - 1105 MHz**
**Pin Descriptions**

| Pin Number  | Function | Description  |
|---|----------|--|
| 1   | AVDD     | DC Power Supply for analog circuitry.  |
| 2, 5, 6, 8, 9,<br>11 - 14, 18 - 22,<br>24, 26, 34, 37, 38 | N/C      | The pins are not connected internally; however, all data shown herein was measured with these pins connected to RF/DC ground externally.   |
| 3   | VPPCP    | Power Supply for charge pump analog section  |
| 4   | CP       | Charge Pump Output   |
| 7   | VDDCP    | Power Supply for the charge pump digital section   |
| 10  | RVDD     | Reference Supply   |
| 15  | XREFP    | Reference Oscillator Input   |
| 16  | DVDD3V   | DC Power Supply for Digital (CMOS) Circuitry   |
| 17  | CEN      | Chip Enable. Connect to logic high for normal operation.   |
| 23  | VTUNE    | VCO Varactor. Tuning Port Input.   |
| 25  | VCC2     | VCO Analog Supply 2  |
| 27  | VCC1     | VCO Analog Supply 1  |
| 28  | RF_N     | VCO Divide by 2 RF Positive Output   |
| 29  | RF_P     | VCO Divide by 2 RF Negative Output   |
| 30  | SEN      | PLL Serial Port Enable (CMOS) Logic Input  |
| 31  | SDI      | PLL Serial Port Data (CMOS) Logic Input  |
| 32  | SCK      | PLL Serial Port Clock (CMOS) Logic Input   |
| 33  | LD_SDO   | Lock Detect, or Serial Data, or General Purpose (CMOS) Logic Output (GPO)  |
| 35  | VCCHF    | DC Power Supply for Analog Circuitry   |
| 36  | VCCPS    | DC Power Supply for Analog Prescaler   |
| 39  | VCCPD    | DC Power Supply for Phase Detector   |
| 40  | BIAS     | External bypass decoupling for precision bias circuits.<br>Note: 1.920V $\pm$ 20mV reference voltage (BIAS) is generated internally and cannot drive an external load. Must be measured with 10G $\Omega$ meter such as Agilent 34410A, normal 10M $\Omega$ DVM will read erroneously. |



**FRACTIONAL-N SYNTHESIZER WITH  
INTEGRATED VCO, 990 - 1105 MHz****Absolute Maximum Ratings**

|  |                |
|--|----------------|
| AVDD, RVDD, DVDD3V, VCCPD, VCCHF, VCCPS                              | -0.3V to +3.6V |
| VPPCP, VDDCP, VCC1   | -0.3V to +5.8V |
| VCC2   | -0.3V to +5.5V |
| Operating Temperature  | -40°C to +85°C |
| Storage Temperature  | -65°C to 125°C |
| Maximum Junction Temperature   | 125 °C         |
| Thermal Resistance (R <sub>TH</sub> )<br>(junction to ground paddle) | 20 °C/W        |
| Reflow Soldering   |                |
| Peak Temperature   | 260°C          |
| Time at Peak Temperature   | 40 sec         |
| ESD Sensitivity (HBM)  | Class 1B       |

Stresses above those listed under Absolute Maximum Ratings may cause permanent damage to the device. This is a stress rating only; functional operation of the device at these or any other conditions above those indicated in the operational section of this specification is not implied. Exposure to absolute maximum rating conditions for extended periods may affect device reliability.

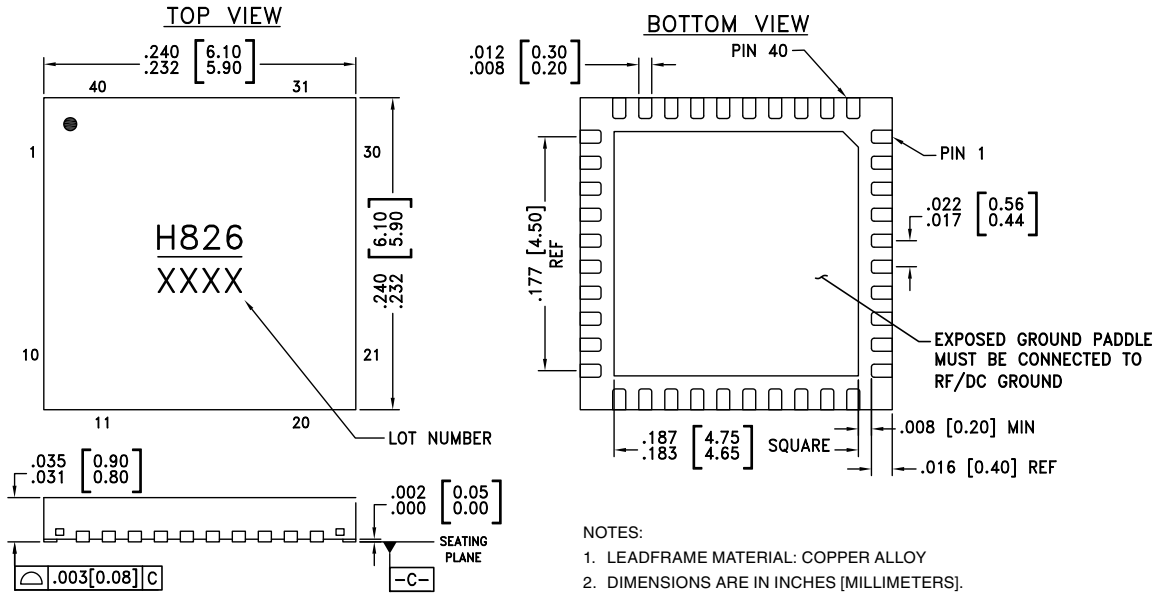
**FRACTIONAL-N SYNTHESIZER WITH  
INTEGRATED VCO, 990 - 1105 MHz**
**Outline Drawing**

**Package Information**

| Part Number | Package Body Material                              | Lead Finish   | MSL Rating | Package Marking <sup>[1]</sup> |
|-------------|--|---------------|------------|--------------------------------|
| HMC826LP6CE | RoHS-compliant Low Stress Injection Molded Plastic | 100% matte Sn | MSL1       | H826<br>XXXX                   |

[1] 4-Digit lot number XXXX



## FRACTIONAL-N SYNTHESIZER WITH INTEGRATED VCO, 990 - 1105 MHz

### Evaluation PCB

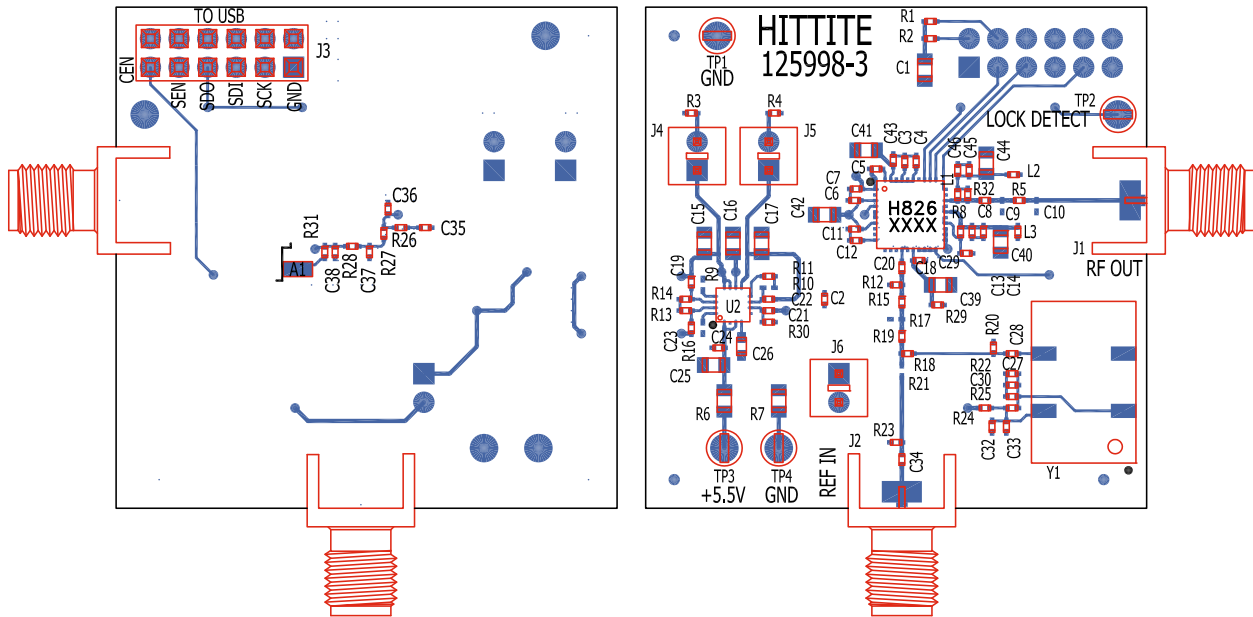

The circuit board used in the application should use RF circuit design techniques. Signal lines should have 50 Ohm impedance while the package ground leads and exposed paddle should be connected directly to the ground plane similar to that shown. A sufficient number of via holes should be used to connect the top and bottom ground planes. The evaluation circuit board shown is available from Hittite upon request.

### Evaluation PCB Schematic

To view this [Evaluation PCB Schematic](#) please visit [www.hittite.com](http://www.hittite.com) and choose HMC826LP6CE from the "Search by Part Number" pull down menu to view the product splash page.

**FRACTIONAL-N SYNTHESIZER WITH  
INTEGRATED VCO, 990 - 1105 MHz**
**List of Materials for Evaluation PCB 127829 [1]**

| Item   | Description                                   |
|--|---|
| J1, J2   | PCB Mount SMA RF Connector                    |
| J3   | Dual Row Terminal Strip                       |
| J4 - J6  | Connector Header                              |
| C1, C15 - C17, C25                                   | 10 $\mu$ F Capacitor, 0805 Pkg.               |
| C2, C3, C6, C7, C11, C12,<br>C14, C18, C27, C43, C45 | 0.47 $\mu$ F Capacitor, 0402 Pkg.             |
| C4, C13  | 22 pF Capacitor, 0402 Pkg.                    |
| C5, C33  | 1000 pF Capacitor, 0402 Pkg.                  |
| C8   | 1.5 pF Capacitor, 0402 Pkg.                   |
| C19 - C24, C28, C30 - C32, C34                       | 0.1 $\mu$ F Capacitor, 0402 Pkg.              |
| C26  | 1 $\mu$ F Capacitor, 0603 Pkg.                |
| C29  | 47 pF Capacitor, 0402 Pkg.                    |
| C35  | 3300 pF Capacitor, 0402 Pkg.                  |
| C36  | 270 pF Capacitor, 0402 Pkg.                   |
| C37, C38   | 68 pF Capacitor, 0402 Pkg.                    |
| C39 - C42, C44                                       | 4.7 $\mu$ F Tantalum Capacitor, 0805 Pkg      |
| C46  | 27 pF Capacitor, 0402 Pkg.                    |
| R1, R2, R5, R11, R15, R18, R19, R21, R24             | 0 Ohm Resistor, 0402 Pkg.                     |
| R3, R4   | 1 Ohm Resistor, 0402 Pkg.                     |
| R6, R7   | 0 Ohm Resistor, 0805 Pkg.                     |
| R8   | 22 Ohm Resistor, 0402 Pkg.                    |
| R12, R20, R29  | 51 Ohm Resistor, 0402 Pkg.                    |
| R22, R25   | 20 kOhm Resistor, 0402 Pkg.                   |
| R26 - R28  | 1k Ohm Resistor, 0402 Pkg.                    |
| L1   | 8.2 nH Inductor, 0402 Pkg.                    |
| L2, L3   | 47 nH Inductor, 0402 Pkg.                     |
| TP3, TP4   | Test Point PC Compact SMT                     |
| U1   | HMC826LP6CE PLL with Integrated VCO           |
| U2   | HMC860LP3E<br>Low Noise Quad Linear Regulator |
| Y1   | 3.3V, 50 MHz VCXO Crystal Oscillator          |
| PCB [2]  | 125998 Evaluation Board                       |

[1] Reference this number when ordering complete evaluation PCB

[2] Circuit Board Material: Rogers 4350 or Arlon 25FR and FR4



## Стандарт Электрон Связь

Мы молодая и активно развивающаяся компания в области поставок электронных компонентов. Мы поставляем электронные компоненты отечественного и импортного производства напрямую от производителей и с крупнейших складов мира.

Благодаря сотрудничеству с мировыми поставщиками мы осуществляем комплексные и плановые поставки широчайшего спектра электронных компонентов.

Собственная эффективная логистика и склад в обеспечивает надежную поставку продукции в точно указанные сроки по всей России.

Мы осуществляем техническую поддержку нашим клиентам и предпродажную проверку качества продукции. На все поставляемые продукты мы предоставляем гарантию .

Осуществляем поставки продукции под контролем ВП МО РФ на предприятия военно-промышленного комплекса России , а также работаем в рамках 275 ФЗ с открытием отдельных счетов в уполномоченном банке. Система менеджмента качества компании соответствует требованиям ГОСТ ISO 9001.

Минимальные сроки поставки, гибкие цены, неограниченный ассортимент и индивидуальный подход к клиентам являются основой для выстраивания долгосрочного и эффективного сотрудничества с предприятиями радиоэлектронной промышленности, предприятиями ВПК и научно-исследовательскими институтами России.

С нами вы становитесь еще успешнее!

### Наши контакты:

**Телефон:** +7 812 627 14 35

**Электронная почта:** [sales@st-electron.ru](mailto:sales@st-electron.ru)

**Адрес:** 198099, Санкт-Петербург,  
Промышленная ул, дом № 19, литера Н,  
помещение 100-Н Офис 331