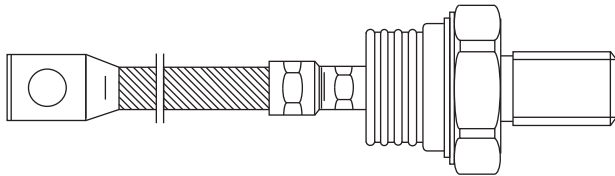

Fast Recovery Diodes (Stud Version), 400 A, 450 A

B-8

PRODUCT SUMMARY	
$I_{F(AV)}$	400 A, 450 A
Package	B-8
Circuit configuration	Single diode

FEATURES

- High power fast recovery diode series
- 2.0 μ s to 3.0 μ s recovery time
- High voltage ratings up to 2500 V
- High current capability
- Optimized turn-on and turn-off characteristics
- Low forward recovery
- Fast and soft reverse recovery
- Compression bonded encapsulation
- Stud version case style B-8
- Maximum junction temperature 150 °C
- Designed and qualified for industrial level
- Material categorization: For definitions of compliance please see www.vishay.com/doc?99912

**RoHS
COMPLIANT**

TYPICAL APPLICATIONS

- Snubber diode for GTO
- High voltage freewheeling diode
- Fast recovery rectifier applications

MAJOR RATINGS AND CHARACTERISTICS				
PARAMETER	TEST CONDITIONS	SD453N/R		UNITS
		S20	S30	
$I_{F(AV)}$		400	450	A
	T_C	70	70	°C
$I_{F(RMS)}$		630	710	A
I_{FSM}	50 Hz	9300	9600	
	60 Hz	9730	10 050	
V_{RRM}	Range	1200 to 2500	1200 to 2500	V
t_{rr}		2.0	3.0	μ s
	T_J	25	25	°C
T_J		- 40 to 150	- 40 to 150	

ELECTRICAL SPECIFICATIONS

VOLTAGE RATINGS				
TYPE NUMBER	VOLTAGE CODE	V_{RRM} , MAXIMUM REPETITIVE PEAK REVERSE VOLTAGE V	V_{RSM} , MAXIMUM NON-REPETITIVE PEAK REVERSE VOLTAGE V	I_{RRM} MAXIMUM AT $T_J = T_J$ MAXIMUM mA
VS-SD453N/R	12	1200	1300	50
	16	1600	1700	
	20	2000	2100	
	25	2500	2600	



FORWARD CONDUCTION							
PARAMETER	SYMBOL	TEST CONDITIONS		SD453N/R		UNITS	
				S20	S30		
Maximum average forward current at case temperature	$I_{F(AV)}$	180° conduction, half sine wave		400	450	A	
				70	70	°C	
Maximum RMS forward current at case temperature	$I_{F(RMS)}$			630	710	A	
				55	52	°C	
Maximum peak, one-cycle forward, non-repetitive surge current	I_{FSM}	t = 10 ms	No voltage reappplied	Sinusoidal half wave, initial $T_J = T_J$ maximum	9300	9600	A
		t = 8.3 ms			9730	10 050	
		t = 10 ms	100 % V_{RRM} reappplied		7820	8070	
		t = 8.3 ms			8190	8450	
Maximum I^2t for fusing	I^2t	t = 10 ms	No voltage reappplied		432	460	kA ² s
		t = 8.3 ms			395	420	
		t = 10 ms	100 % V_{RRM} reappplied		306	326	
		t = 8.3 ms			279	297	
Maximum $I^2\sqrt{t}$ for fusing	$I^2\sqrt{t}$	t = 0.1 to 10 ms, no voltage reappplied		4320	4600	kA ² √s	
Low level value of threshold voltage	$V_{F(TO)1}$	(16.7 % $\times \pi \times I_{F(AV)} < I < \pi \times I_{F(AV)}$, $T_J = T_J$ maximum)		1.00	0.95	V	
High level value of threshold voltage	$V_{F(TO)2}$	(I $> \pi \times I_{F(AV)}$, $T_J = T_J$ maximum)		1.09	1.04		
Low level value of forward slope resistance	r_{f1}	(16.7 % $\times \pi \times I_{F(AV)} < I < \pi \times I_{F(AV)}$, $T_J = T_J$ maximum)		0.80	0.60	mW	
High level value of forward slope resistance	r_{f2}	(I $> \pi \times I_{F(AV)}$, $T_J = T_J$ maximum)		0.74	0.54		
Maximum forward voltage drop	V_{FM}	$I_{pk} = 1500$ A, $T_J = T_J$ maximum, $t_p = 10$ ms sinusoidal wave		2.20	1.85	V	

RECOVERY CHARACTERISTICS								
CODE	MAXIMUM VALUE AT $T_J = 25$ °C	TEST CONDITIONS			TYPICAL VALUES AT $T_J = 150$ °C			
	t_{rr} AT 25 % I_{RRM} (μs)	I_{pk} SQUARE PULSE (A)	dI/dt (A/μs)	V_r (V)	t_{rr} AT 25 % I_{RRM} (μs)	Q_{rr} (μC)	I_{rr} (A)	
S20	2.0	1000	50	- 50	3.5	250	120	
S30	3.0				5.0	380	150	

THERMAL AND MECHANICAL SPECIFICATIONS				
PARAMETER	SYMBOL	TEST CONDITIONS	VALUES	UNITS
Maximum junction operating and storage temperature range	T_J, T_{Stg}		- 40 to 150	°C
Maximum thermal resistance, junction to case	R_{thJC}	DC operation	0.1	K/W
Maximum thermal resistance, case to heatsink	R_{thCS}	Mounting surface, smooth, flat and greased	0.04	
Mounting torque ± 10 %		Not-lubricated threads	50	Nm
Approximate weight			454	g
Case style		See dimensions (link at the end of datasheet)	B-8	

ΔR_{thJC} CONDUCTION				
CONDUCTION ANGLE	SINUSOIDAL CONDUCTION	RECTANGULAR CONDUCTION	TEST CONDITIONS	UNITS
180°	0.010	0.008	$T_J = T_J$ maximum	K/W
120°	0.014	0.014		
90°	0.017	0.019		
60°	0.025	0.026		
30°	0.042	0.042		

Note

- The table above shows the increment of thermal resistance R_{thJC} when devices operate at different conduction angles than DC

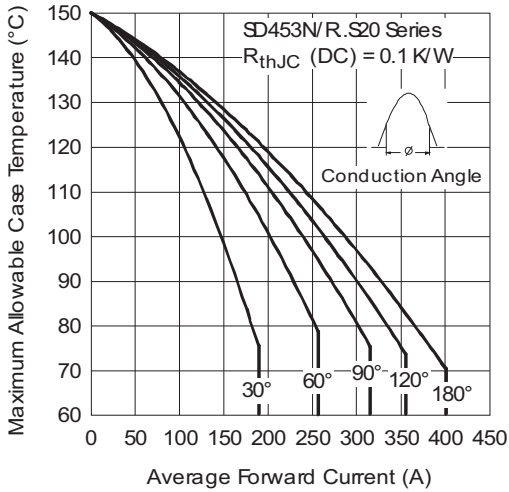

Fig. 1 - Current Ratings Characteristics

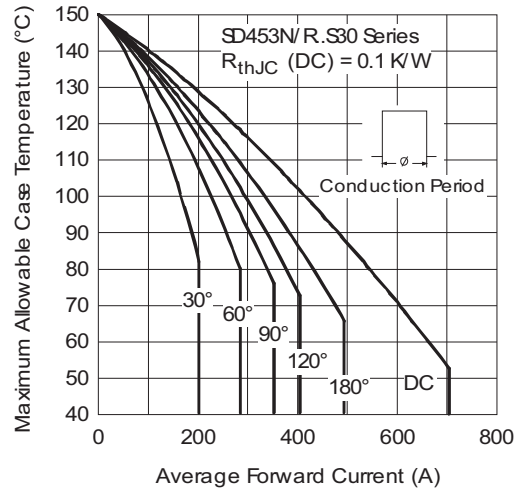

Fig. 4 - Current Ratings Characteristics

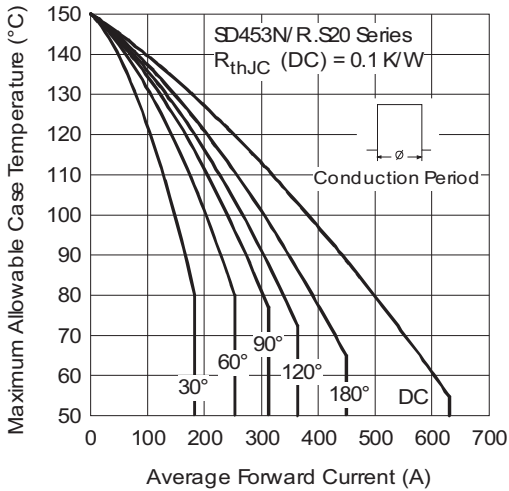

Fig. 2 - Current Ratings Characteristics

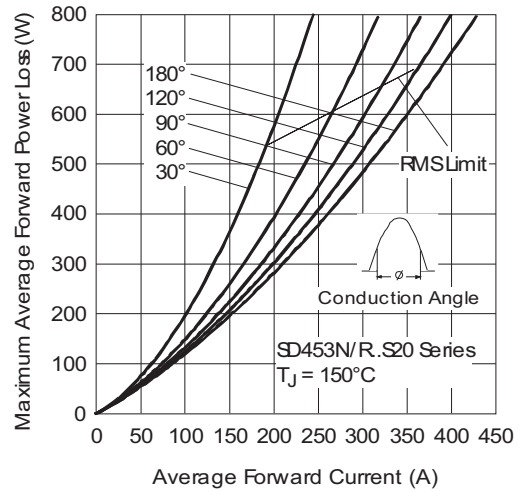

Fig. 5 - Forward Power Loss Characteristics

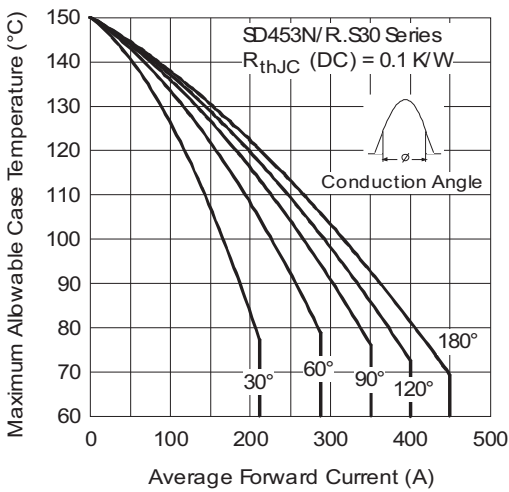

Fig. 3 - Current Ratings Characteristics

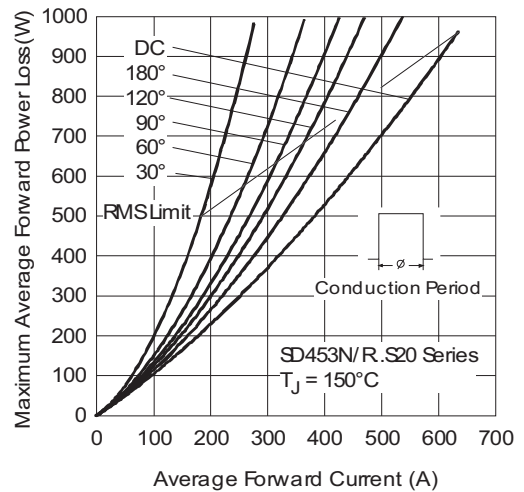

Fig. 6 - Forward Power Loss Characteristics

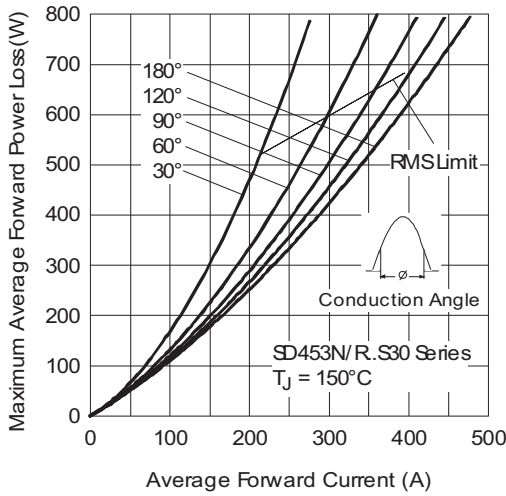

Fig. 7 - Forward Power Loss Characteristics

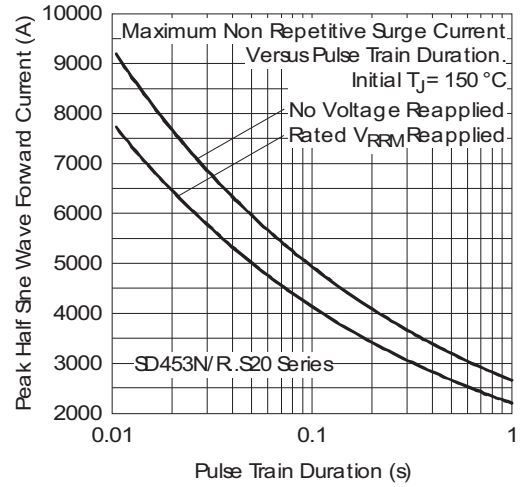

Fig. 10 - Maximum Non-Repetitive Surge Current

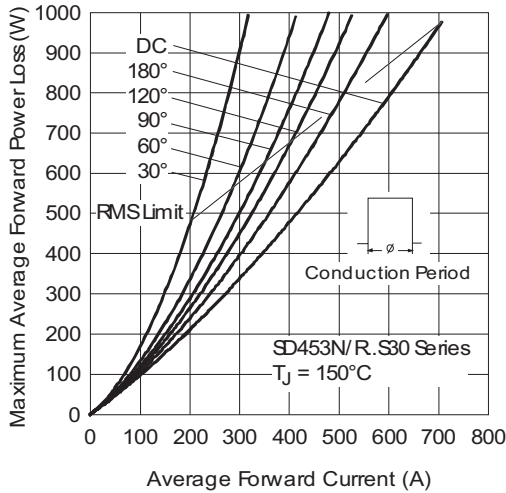

Fig. 8 - Forward Power Loss Characteristics

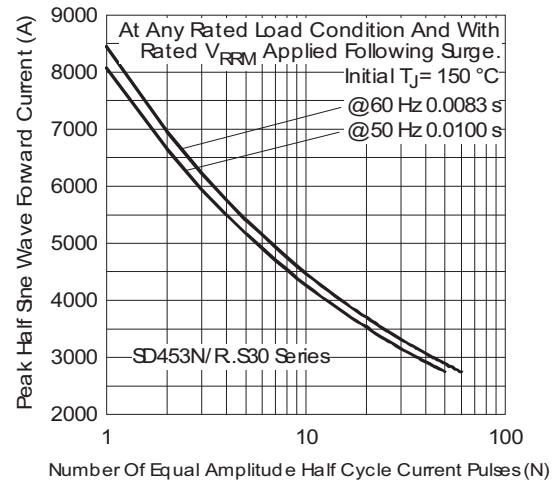

Fig. 11 - Maximum Non-Repetitive Surge Current

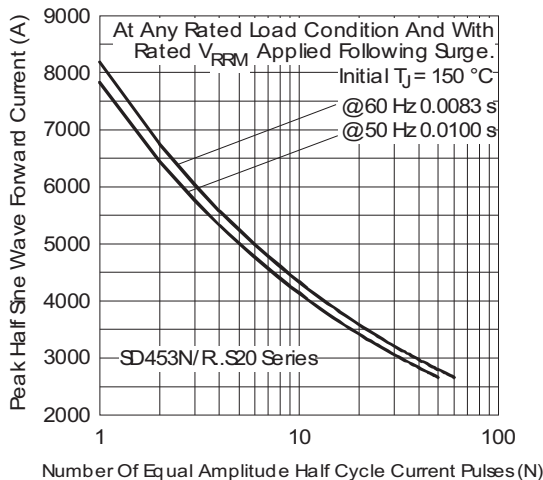

Fig. 9 - Maximum Non-Repetitive Surge Current

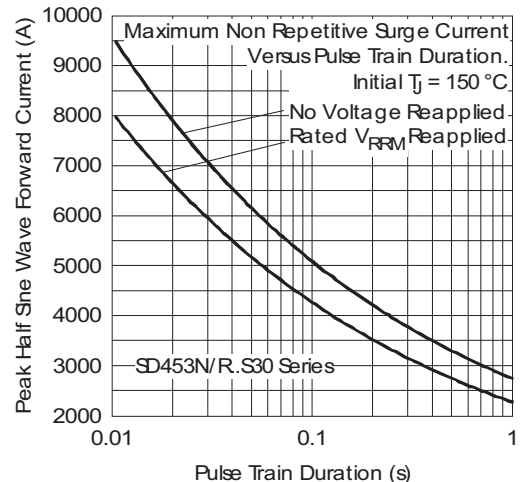

Fig. 12 - Maximum Non-Repetitive Surge Current

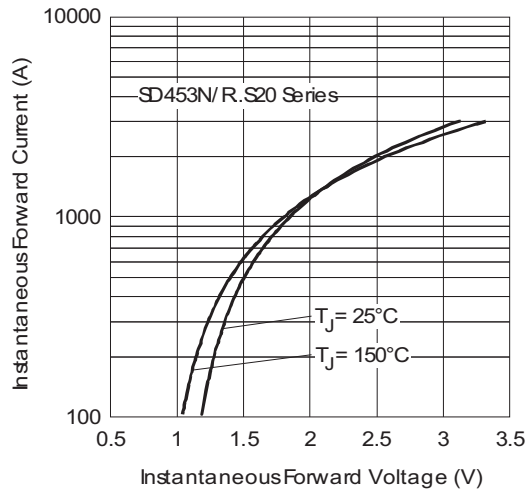

Fig. 13 - Forward Voltage Drop Characteristics

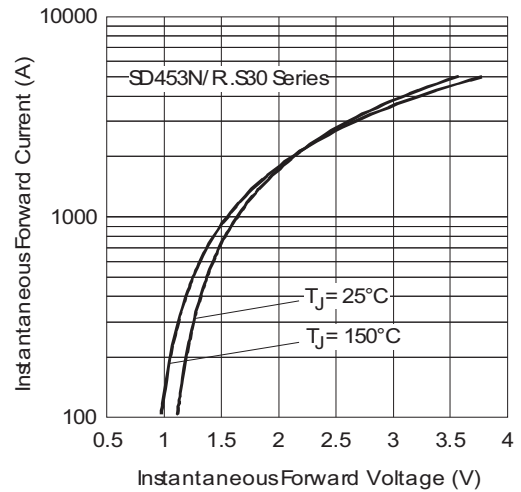

Fig. 14 - Forward Voltage Drop Characteristics

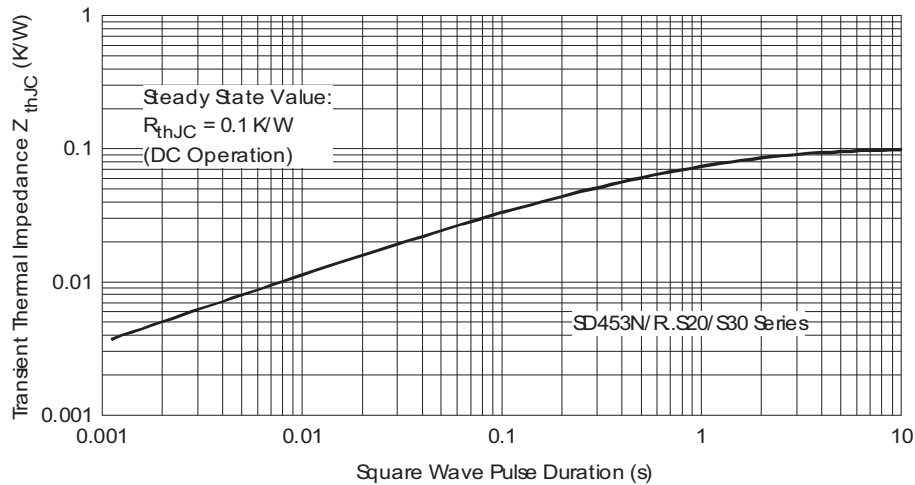

Fig. 15 - Thermal Impedance Z_{thJC} Characteristic

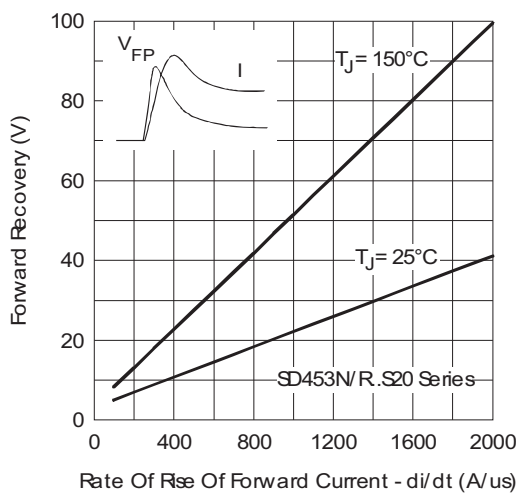

Fig. 16 - Typical Forward Recovery Characteristics

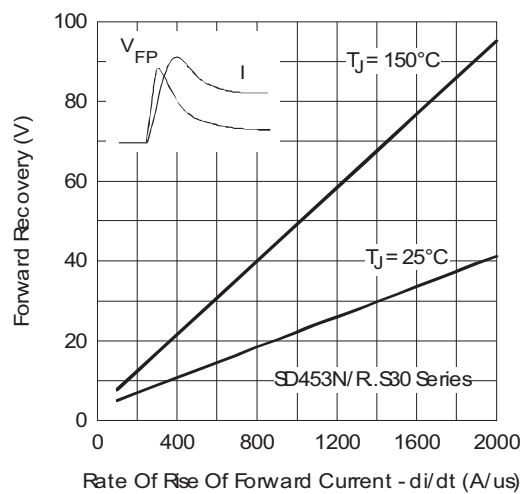
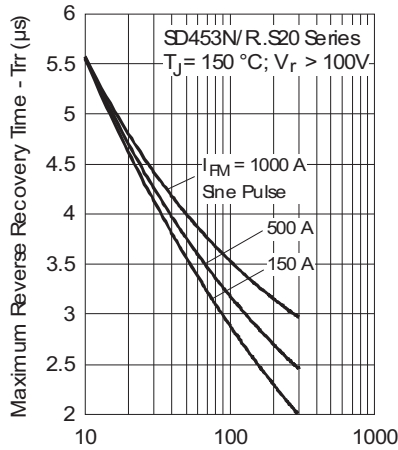
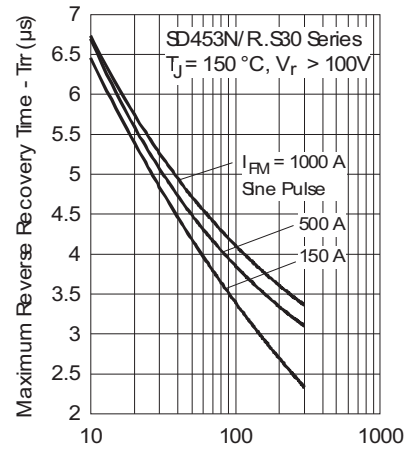

Fig. 17 - Typical Forward Recovery Characteristics



Rate Of Fall Of Forward Current - di/dt (A/µs)

Fig. 18 - Recovery Time Characteristics



Rate Of Fall Of Forward Current - di/dt (A/µs)

Fig. 21 - Recovery Time Characteristics

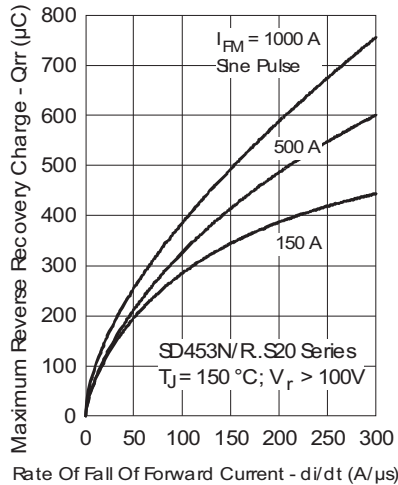

Rate Of Fall Of Forward Current - di/dt (A/µs)

Fig. 19 - Recovery Charge Characteristics

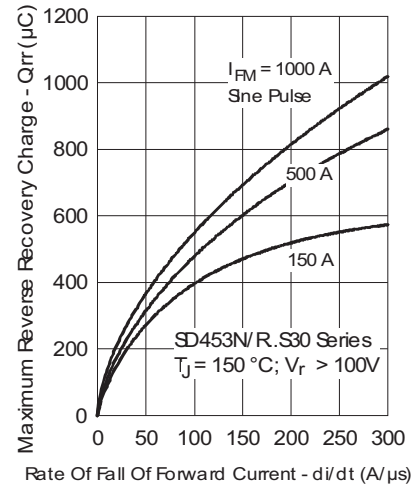

Rate Of Fall Of Forward Current - di/dt (A/µs)

Fig. 22 - Recovery Charge Characteristics

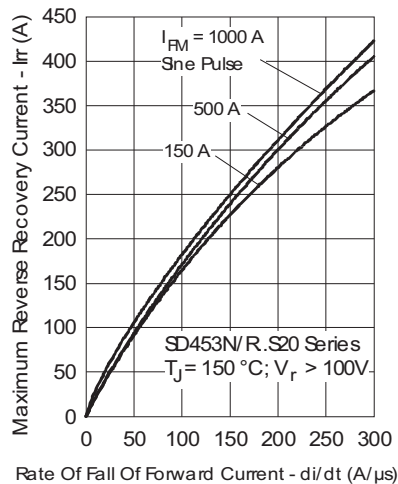

Rate Of Fall Of Forward Current - di/dt (A/µs)

Fig. 20 - Recovery Current Characteristics

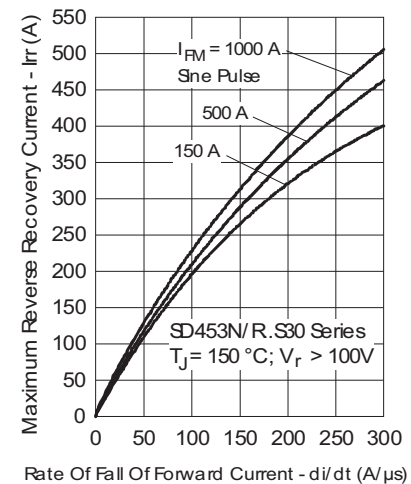

Rate Of Fall Of Forward Current - di/dt (A/µs)

Fig. 23 - Recovery Current Characteristics

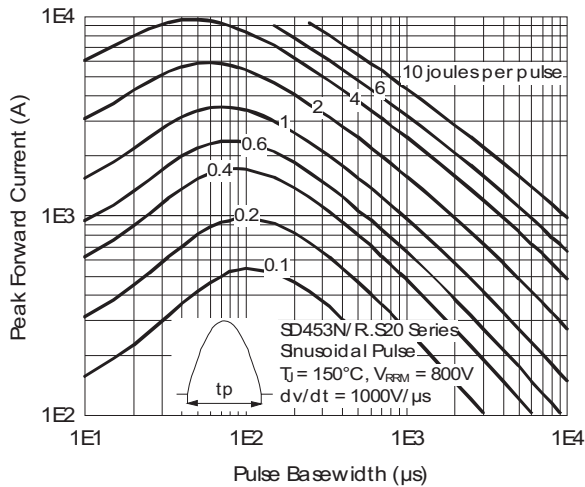

Fig. 24 - Maximum Total Energy Loss Per Pulse Characteristics

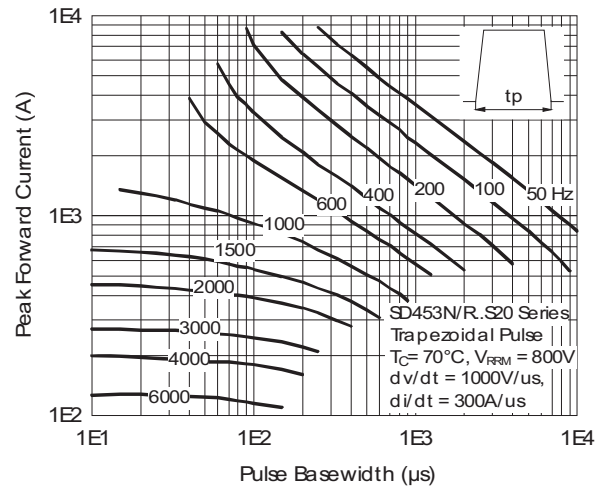

Fig. 27 - Frequency Characteristics

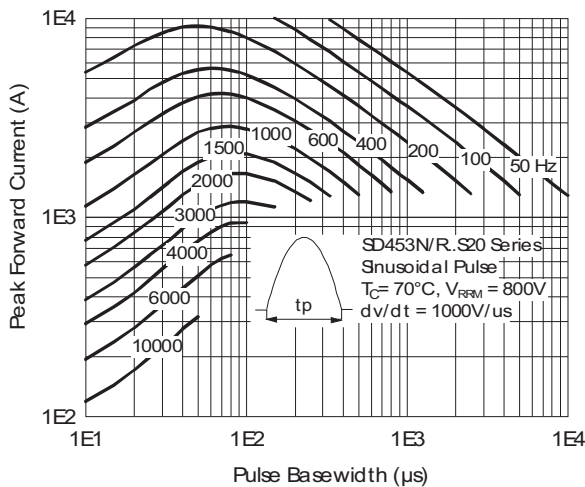

Fig. 25 - Frequency Characteristics

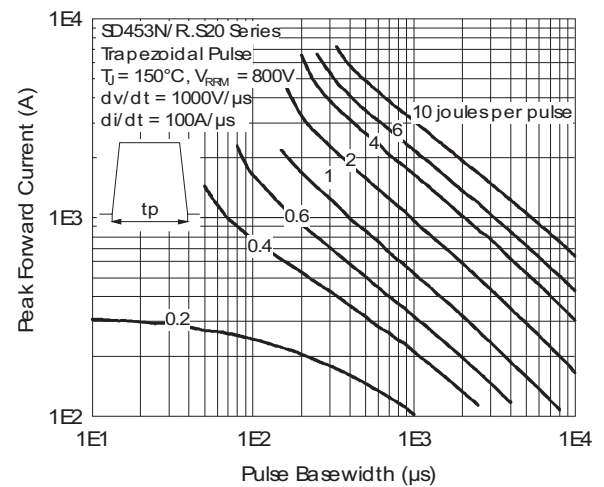

Fig. 28 - Maximum Total Energy Loss Per Pulse Characteristics

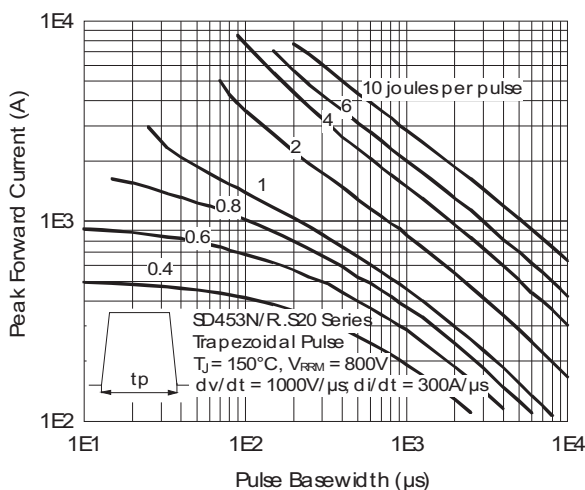

Fig. 26 - Maximum Total Energy Loss Per Pulse Characteristics

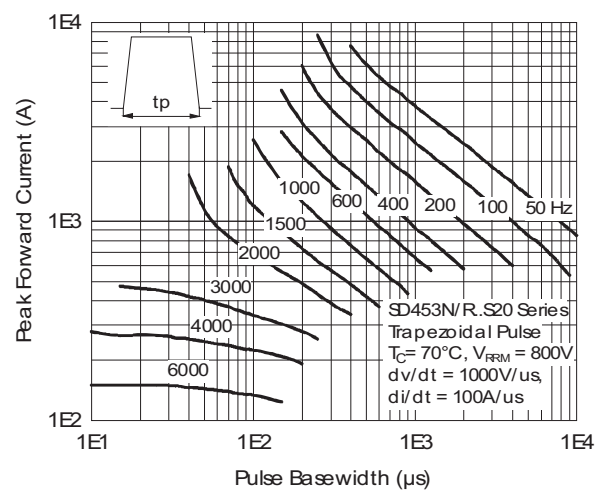

Fig. 29 - Frequency Characteristics

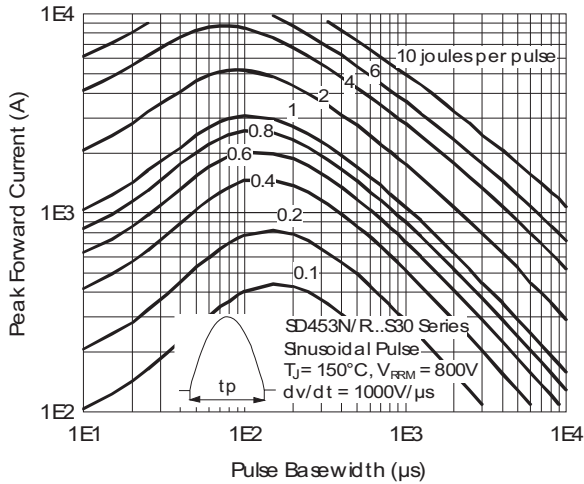

Fig. 30 - Maximum Total Energy Loss Per Pulse Characteristics

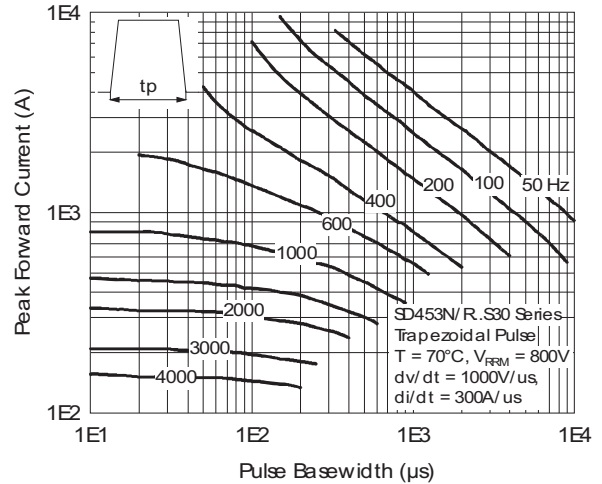

Fig. 33 - Frequency Characteristics

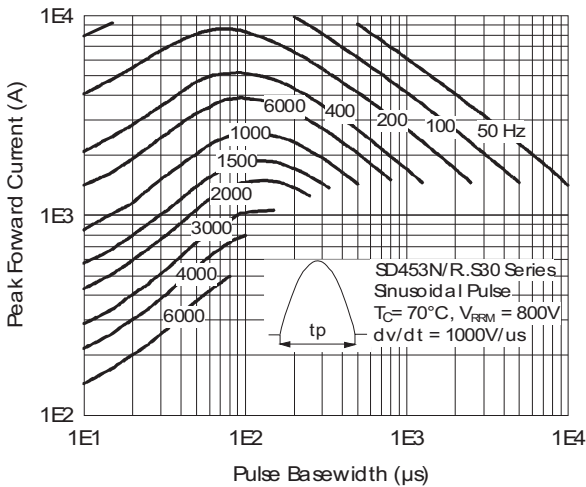

Fig. 31 - Frequency Characteristics

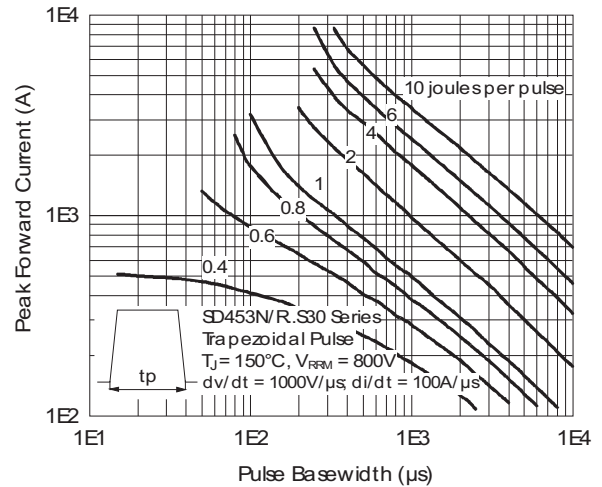

Fig. 34 - Maximum Total Energy Loss Per Pulse Characteristics

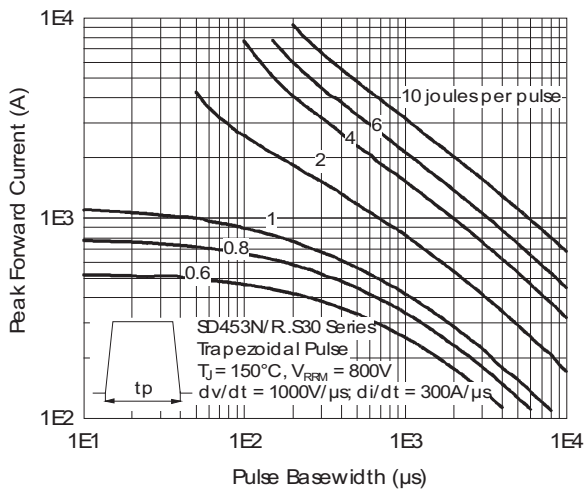

Fig. 32 - Maximum Total Energy Loss Per Pulse Characteristics

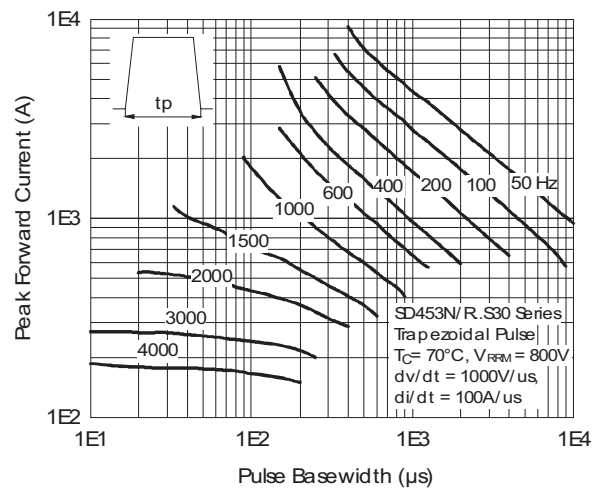

Fig. 35 - Frequency Characteristics



ORDERING INFORMATION TABLE

Device code	VS-	SD	45	3	N	25	S30	P	S	C
	①	②	③	④	⑤	⑥	⑦	⑧	⑨	⑩

- 1** - Vishay Semiconductors product
- 2** - Diode
- 3** - Essential part number
- 4** - 3 = Fast recovery
- 5** -
 - N = Stud normal polarity (cathode to stud)
 - R = Stud reverse polarity (anode to stud)
- 6** - Voltage code x 100 = V_{RRM} (see Voltage Ratings table)
- 7** - t_{rr} code (see Recovery Characteristics table)
- 8** -
 - P = Stud base B-8 3/4" 16UNF-2A
 - M = Stud base B-8 M24 x 1.5
- 9** -
 - S = Isolated lead with silicon sleeve
(red = Reverse polarity; blue = Normal polarity)
 - None = Not isolated lead
 - T = Threaded top terminal 3/8" 24UNF-2A
- 10** - C = Ceramic housing

LINKS TO RELATED DOCUMENTS	
Dimensions	www.vishay.com/doc?95303

B-8

DIMENSIONS in millimeters (inches)

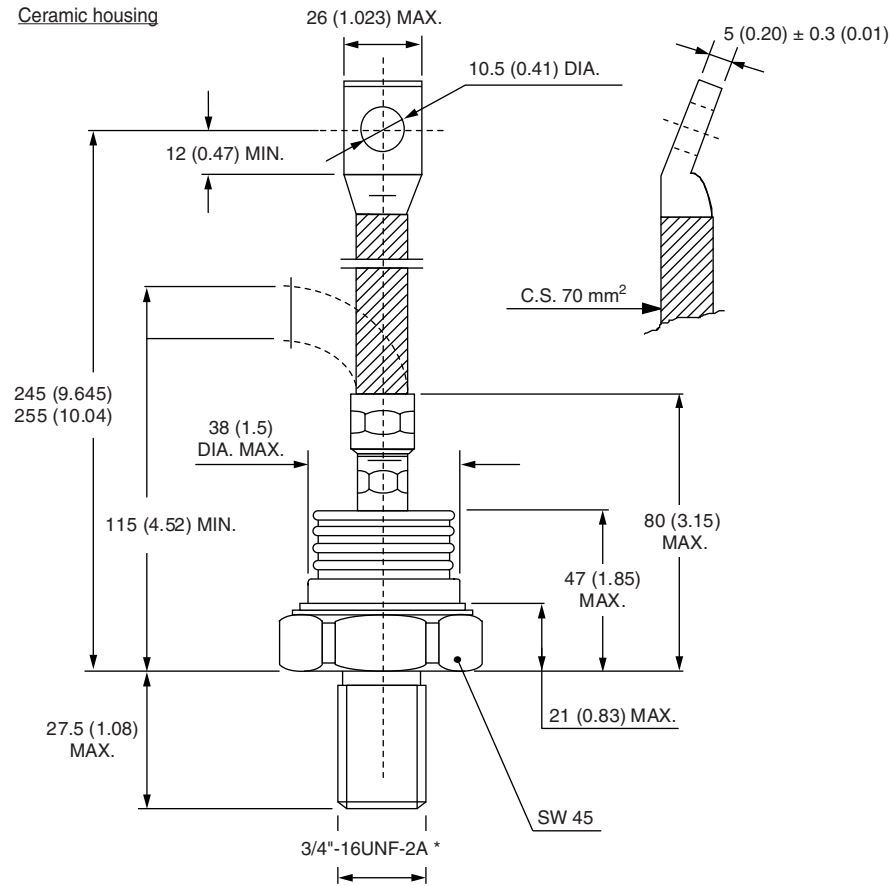

*For metric device: M24 x 1.5 - length 21 (0.83) MAX.
contact factory



Disclaimer

ALL PRODUCT, PRODUCT SPECIFICATIONS AND DATA ARE SUBJECT TO CHANGE WITHOUT NOTICE TO IMPROVE RELIABILITY, FUNCTION OR DESIGN OR OTHERWISE.

Vishay Intertechnology, Inc., its affiliates, agents, and employees, and all persons acting on its or their behalf (collectively, "Vishay"), disclaim any and all liability for any errors, inaccuracies or incompleteness contained in any datasheet or in any other disclosure relating to any product.

Vishay makes no warranty, representation or guarantee regarding the suitability of the products for any particular purpose or the continuing production of any product. To the maximum extent permitted by applicable law, Vishay disclaims (i) any and all liability arising out of the application or use of any product, (ii) any and all liability, including without limitation special, consequential or incidental damages, and (iii) any and all implied warranties, including warranties of fitness for particular purpose, non-infringement and merchantability.

Statements regarding the suitability of products for certain types of applications are based on Vishay's knowledge of typical requirements that are often placed on Vishay products in generic applications. Such statements are not binding statements about the suitability of products for a particular application. It is the customer's responsibility to validate that a particular product with the properties described in the product specification is suitable for use in a particular application. Parameters provided in datasheets and/or specifications may vary in different applications and performance may vary over time. All operating parameters, including typical parameters, must be validated for each customer application by the customer's technical experts. Product specifications do not expand or otherwise modify Vishay's terms and conditions of purchase, including but not limited to the warranty expressed therein.

Except as expressly indicated in writing, Vishay products are not designed for use in medical, life-saving, or life-sustaining applications or for any other application in which the failure of the Vishay product could result in personal injury or death. Customers using or selling Vishay products not expressly indicated for use in such applications do so at their own risk. Please contact authorized Vishay personnel to obtain written terms and conditions regarding products designed for such applications.

No license, express or implied, by estoppel or otherwise, to any intellectual property rights is granted by this document or by any conduct of Vishay. Product names and markings noted herein may be trademarks of their respective owners.

Material Category Policy

Vishay Intertechnology, Inc. hereby certifies that all its products that are identified as RoHS-Compliant fulfill the definitions and restrictions defined under Directive 2011/65/EU of The European Parliament and of the Council of June 8, 2011 on the restriction of the use of certain hazardous substances in electrical and electronic equipment (EEE) - recast, unless otherwise specified as non-compliant.

Please note that some Vishay documentation may still make reference to RoHS Directive 2002/95/EC. We confirm that all the products identified as being compliant to Directive 2002/95/EC conform to Directive 2011/65/EU.

Vishay Intertechnology, Inc. hereby certifies that all its products that are identified as Halogen-Free follow Halogen-Free requirements as per JEDEC JS709A standards. Please note that some Vishay documentation may still make reference to the IEC 61249-2-21 definition. We confirm that all the products identified as being compliant to IEC 61249-2-21 conform to JEDEC JS709A standards.



Стандарт Электрон Связь

Мы молодая и активно развивающаяся компания в области поставок электронных компонентов. Мы поставляем электронные компоненты отечественного и импортного производства напрямую от производителей и с крупнейших складов мира.

Благодаря сотрудничеству с мировыми поставщиками мы осуществляем комплексные и плановые поставки широчайшего спектра электронных компонентов.

Собственная эффективная логистика и склад в обеспечивает надежную поставку продукции в точно указанные сроки по всей России.

Мы осуществляем техническую поддержку нашим клиентам и предпродажную проверку качества продукции. На все поставляемые продукты мы предоставляем гарантию .

Осуществляем поставки продукции под контролем ВП МО РФ на предприятия военно-промышленного комплекса России , а также работаем в рамках 275 ФЗ с открытием отдельных счетов в уполномоченном банке. Система менеджмента качества компании соответствует требованиям ГОСТ ISO 9001.

Минимальные сроки поставки, гибкие цены, неограниченный ассортимент и индивидуальный подход к клиентам являются основой для выстраивания долгосрочного и эффективного сотрудничества с предприятиями радиоэлектронной промышленности, предприятиями ВПК и научно-исследовательскими институтами России.

С нами вы становитесь еще успешнее!

Наши контакты:

Телефон: +7 812 627 14 35

Электронная почта: sales@st-electron.ru

Адрес: 198099, Санкт-Петербург,
Промышленная ул, дом № 19, литера Н,
помещение 100-Н Офис 331