

**Power Contacts**

**Type I, Crimp, Snap-In**



Pin



Socket

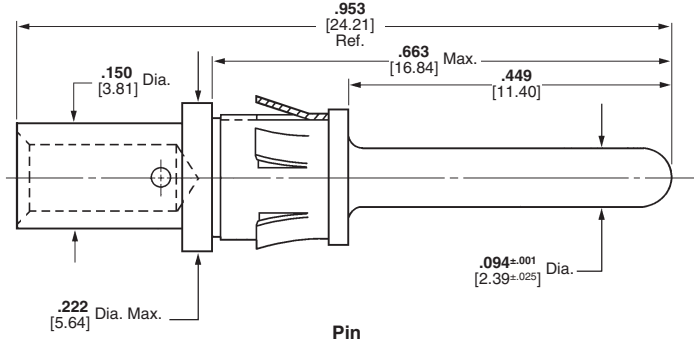

Pin

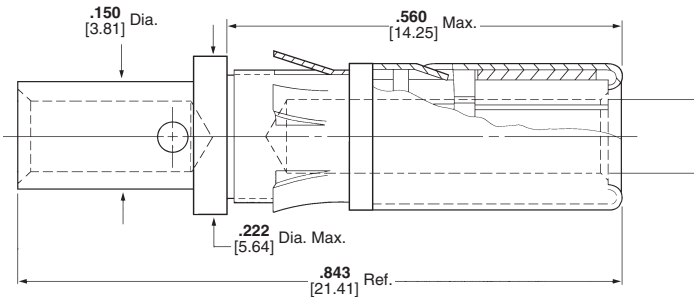

Socket

**Material**

**Contact Body**—Bronze  
**Retention Spring**—Beryllium copper

**Finish**

**Contact Body**—.000030 [0.00076] gold over .000050 [0.00127] nickel.  
Gold thickness controlled on socket O.D.

**Retention Spring**—Nickel plated

**Related Product Data**

**Application Tooling**—Pages 29, 30

**Technical Documents**

108-10108 Product Specification  
114-10037 Application Specification

**Size 12—Pin Diameter .094 [2.39] (Test Current, 23 Ampere)‡**

Wire Size Range		Loose Piece Contact No.		Tooling Part No.	
AWG	[mm <sup>2</sup> ]	Pin	Socket	Dies for Pneumatic Tool*	Hand Tool
18-16	0.8-1.4	202421-1	202418-1	90122	90121
14-12	2-3	202422-1	202417-1	90122	90121

\* Use hand actuated Power Unit **Part No. 189721-2** or foot actuated Power Unit **Part No. 189722-2**. Both units require "C" Head Die Set Adapter **Part No. 318161-1** and an Adapter Holder **Part No. 356304-1** (with ratchet) or **Part No. 189928-1** (without ratchet). Request Catalog 124208 for more information on the 626 Pneumatic Tool System.

‡Single contact, free-air test current; not to be construed as contact rating current. Use only for testing. Refer to contact current carrying capability information, page 3.

Extraction Tool **Part No. 305183-8** (Instruction Sheet 408-1216)

**Note:** All part numbers are RoHS compliant.

**Power Contacts—High Current Upgrade** (Continued)

**Type II and Type III+,  
Size 16**

The features of the High Current Size 16 contact have been designed to fit into the existing AMP Multimate Connectors such as CPC (Circular Plastic Connector), CMC (Circular Metal Connector), G Series, M Series, Econoseal Metrimate Square Grid and Drawer Connector housings. An initial T-Rise test in free air has shown a 23 amp capability with a 30°C T-Rise. The contact may be crimped onto 14 AWG wire with a Tyco Electronics hand tool P/N 601967-1. Use turret TH502 (1-601967-6) for the pin and turret TH501 (1-601967-5) for the socket.

**Material**

**Pin Body** — Leaded Brass;  
Copper Alloy (Board Mount)

**Socket Body** — Copper Alloy

**Louvertac Band** — Beryllium Copper

**Retention Spring** — Stainless Steel

**Finish**

**Body** — Silver

**Louvertac Band** — Gold

Wire Size AWG	High Current Size 16 Socket Part No.	
	Loose Piece	Tape
14	193846-1	193846-2
18-16	796966-1	796966-2

Wire Size AWG	High Current Size 16 Pin Part No.	
	Loose Piece	Tape
14	193844-1	193844-2
18-16	796964-1	796964-2



**4 Pos. CPC Posted Square Flange Receptacle**  
Part No. 796764-1  
Mates with CPC Plug (Part No. 206060-1) with either  
Type II or High Current Socket contact



**Extraction Tool Part No. 305183**

**Current-Carrying Capacity.** The graph shows current-carrying capacity versus temperature rise for a fully energized 6 position Metrimate Square Grid plug P/N 207152-1 and receptacle P/N 207153-1. These initial representative ampere ratings were conducted with 14 AWG wires that were 2 feet long.

**Current Rating for  
30°C Temperature Rise  
100% Energized**  
  
**6 Circuit Metrimate  
Connector (Wire-to-Wire)**

**TEMPERATURE RISE VS. CURRENT**

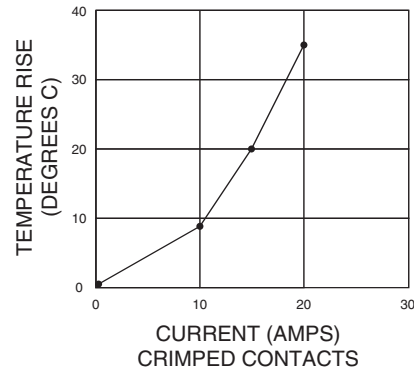

■ **Recognized under the  
Component Program of  
Underwriters  
Laboratories Inc.,**   
File No. E28476

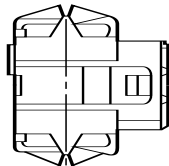
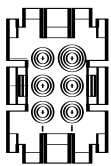

**Plug (for Sockets)**

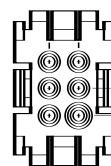
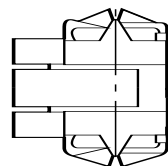
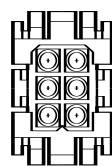
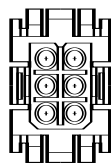

**Receptacle (for Pins)**

- Notes:** 1. High Current contacts with Louvertac bands are NOT intermateable with any other contact.  
2. Additional information on CPC and CMC connectors is available in Catalog 82021.  
3. Additional information on G Series connectors is available in Catalog 82046.  
4. Additional information on M Series connectors is available in Catalog 82003.  
5. Additional information on Metrimate connectors is available in Catalog 82045.  
6. Additional information on Econoseal connectors is available in Catalog 82057.  
7. Additional information on LGH connectors is available in Catalog 82024.

**Note:** All part numbers are RoHS compliant.

**Power Contacts** (Continued)

**.125 POWERBAND Contacts**

**Pin Diameter**—.125 [3.175]  
**Test Current**—50 Amperes‡

**Material and Finish**

**Contact** — Copper  
**Spring** — Beryllium copper  
**Plating Code**  
**A.** 0.00508 [.000200] min. silver on contact area, 0.00127 [.000050] min. on remainder, all over 0.00127 [.000050] min. nickel underplate  
**B.** 0.00076 [.000030] min. gold on contact area, gold flash on remainder, all over 0.00127 [.000050] min. nickel underplate

**Related Product Data**

**Application Tooling**—Pages 29, 30  
**Technical Document**—Page 4

**Extraction Tool**  
**Part No. 318813-1**  
(Instruction Sheet 408-4374)



Wire Size AWG/mm <sup>2</sup>	Contact Finish	Pin Length	Contact Part No.				Tooling Part No.**	
			Strip		Loose Piece		Heavy Duty Miniature (HDM) Applicators (for AMP-O-LECTRIC Model G Machine, Base Part No. 354500)	Die Sets for Hand Tool 69710-1 or 626 Pneumatic Tool System*
			Pin	Socket	Pin	Socket		
14-12 2-3	A	Standard	213845-1	213847-1	213845-3	213847-3	680195-3	356612-1
	B	Standard	213845-2	213847-2	213845-4	213847-4		
	A	Extended <sup>1</sup>	213845-5	—	213845-7	—		
	B	Extended <sup>1</sup>	213845-6	—	213845-8	—		
10-8 5-8	A	Standard	213841-1	213843-1	213841-3	213843-3	680197-3	356611-1 (8 AWG)
	B	Standard	213841-2	213843-2	213841-4	213843-4		
	A	Extended <sup>1</sup>	213841-5	—	213841-7	—		356611-2 (10 AWG)
	B	Extended <sup>1</sup>	213841-6	—	213841-8	—		

<sup>1</sup>For use in Metrimate Drawer Connectors listed in chart below and Two-Piece Sealed Circular Plastic Connectors (CPC), Series 5 and 6.

‡Single contact, free-air test current; not to be construed as contact rating current. Use only for testing.

Refer to contact current carrying capability information, page 3.

**Note:** Standard Size 8, High Current Size 8 upgrade, and .125 POWERBAND contacts are not interchangeable.

\*A typical 626 Pneumatic Tool System requires: a power unit (Part No. 189721-2, hand actuated or 189722-2, foot actuated), an adapter holder (Part No. 356304-1, with ratchet), and "C" Head adapter Part No. 318161-1.

\*\*There are power options available for these tools/dies. See Battery Powered Crimp tool Kit and SDE Electric Terminator on page 30.

**Note:** All part numbers are RoHS compliant.

**.125 POWERBAND Metrimate Drawer Connectors**

No. of Pos.	Housing Part No.	
	Plug	Receptacle
8	213886-1**	213500-3**

Color: blue

\*\*For use with .125 POWERBAND contacts (Extended Pin Length), listed above.

**Note:** All part numbers are RoHS compliant.

**Power Contacts** (Continued)

**Standard, Size 8,  
4/8 Indent Crimp**



Pin



Socket

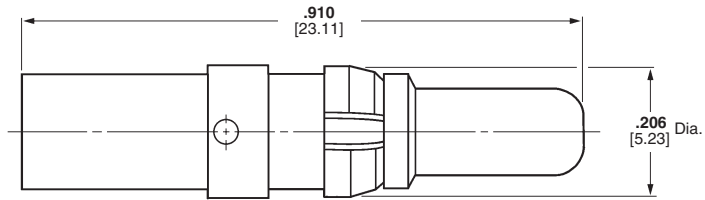

Pin

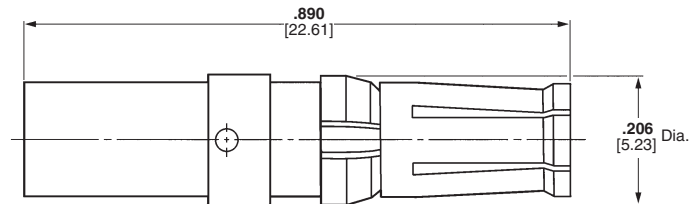

Socket

**Note:** Standard Size 8, High Current Upgrade Size 8 and .125 POWERBAND contacts are **not** intermateable.

**Material**

**Contact Body**—Copper alloy  
**Retention Clip**—Phosphor bronze

**Finish**

**Contact Body**—.000050 [0.00127] gold over .000050 [0.00127] nickel  
**Retention Spring**—Nickel plated

**Related Product Data**

**Technical Documents**

108-10045 Product Specification  
114-10014 Application Specification

**Power Contacts, Standard, Size 8 (Test Current 50 Amperes)‡**

Wire Range		Contacts		Crimping Tools	
AWG	[mm <sup>2</sup> ]	Pin	Socket	Tool No.	Positioner
18-16	0.8-1.4	213567-1	212014-1	608668-1	(P) SP867 (S) 608668-2
14-12	2-3	213662-1	212008-1	608651-1	(P) SP867 (S) 608651-2
10	5	213740-1	213737-1	608651-1	(P) 608651-3 (S) 608651-2
8	8	213552-2	213750-1	608651-1	(P) 608651-3 (S) 608651-2

‡Single contact, free-air test current; not to be construed as contact rating current. Use only for testing. Refer to contact current carrying capability information, page 3.

**Note:** All part numbers are RoHS compliant.

**Power Contacts—High Current Upgrade** (Continued)

**Metrimate Drawer Connector, Size 8**

The Louvertac bands have the versatility of being designed into contact dimensions used in existing Tyco Electronics connectors.

Metrimate High Current contacts have been designed to fit into the existing Drawer Connector housings. A fully energized 8 position connector with 8 gage wires can handle 30 amps per line with a 30°C T-rise on either the cable-to-cable or cable-to-board.



**Cable-to-Cable**

**Material**

- Contact Body** — Copper Alloys
- Louvertac Band** — Beryllium Copper
- Retention Spring** — Stainless Steel
- Finish** — Gold

**Product Specification**

108-1449 Metrimate Pin and Socket with Louvertac High Current Contact

**Connector Voltage Rating** — 600 VAC

■ **Recognized under the Component Program of Underwriters Laboratories Inc., File No. E28476**



■ **Certified by Canadian Standards Association, File No. LR7189A**



**High Current Contacts**

Wire Size AWG	Contact Part Numbers		Crimp Tools
	Pin	Socket	
8	193457-1	193458-1	Daniels† Hand Tool #M310 or AMP P/N 356114-1 Positioner #TP944 or AMP P/N 356336-1
10	193642-1	193643-1	
12-14	193534-1	193535-1	

Extraction Tool Part No. 318813-1 or 305183-6

†Daniels Manufacturing Corp., Orlando, FL  
**Note:** All part numbers are RoHS compliant.

**Cable-to-Board**

**Material**

- Contact Body** — Copper Alloys
- Louvertac Band** — Beryllium Copper
- Retention Spring** — Stainless Steel
- Finish** — Gold

A typical application would have solder tail pins mounted into the receptacle and crimp sockets mounted into the plug.

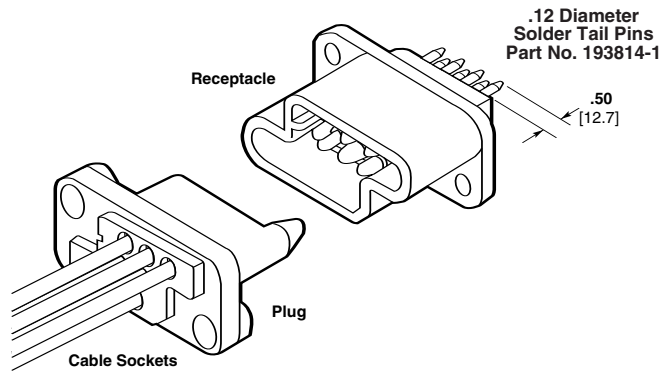

**Drawer Connector Housings**

Size Configuration	Housing Part Numbers	
	Plug	Receptacle
8 Positions (8 Size 8 Cavities)	213499-1	213500-1
15 Positions (3 Size 8 Cavities & 12 Size 16 Cavities)	213426-1	213427-1

Extraction Tool Part No. 318813-1

**Note:** All part numbers are RoHS compliant.

**Notes:** 1. High Current contacts with Louvertac bands are NOT interchangeable with any other contact.  
2. Additional information on connectors is available in Catalog 82045.

■ **Recognized under the Component Program of Underwriters Laboratories Inc., File No. E28476**



■ **Certified by Canadian Standards Association, File No. LR7189A**



**Power Contacts** (Continued)

**Type XII, Precision Formed, Crimp, Snap-In**

**Material**

Copper

**Finish**

- A—Tin-lead
- B—.000030 [0.00076] selective gold over .000030 [0.00076] nickel
- C—.000100 [0.00254] silver plated contacts with lubricant added

**Test Current Rating**

**Silver or Gold**—35 amperes ‡

**Tin Lead**—15 amperes ‡

‡Single contact, free-air test current; not to be construed as contact rating current. Use only for testing. Refer to contact current carrying capability information, page 3.

**Related Product Data**

**Application Tooling**—Pages 29, 30

**Technical Documents**—Page 4



Male



Female

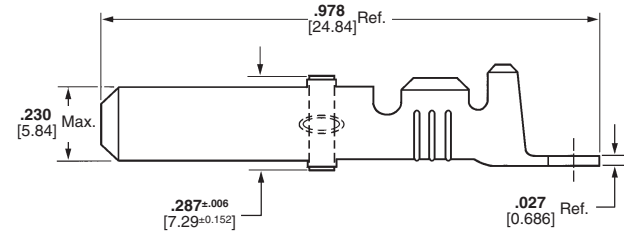
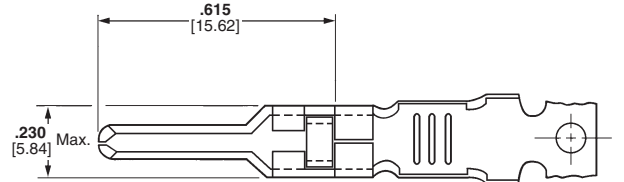

Male

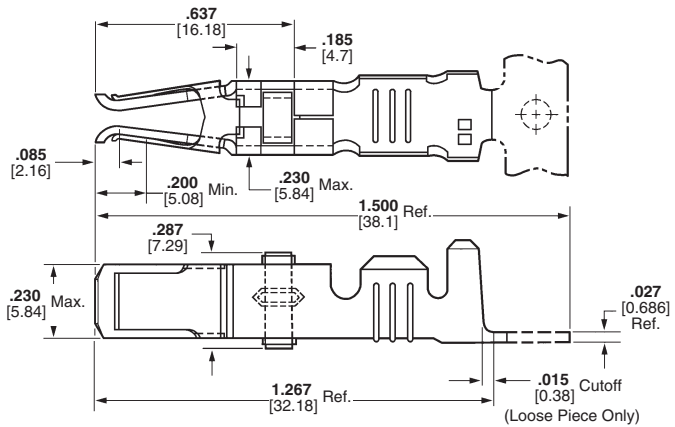

Female

Extraction Tool Part No. 91019-3

Wire Size Range <sup>1</sup>	Ins. Dia. Range	Contact Finish	Strip Form Contact Part Nos.				Loose Piece		Tooling**		
			Standard***		Heavy Duty Miniature***		Contact Part Nos.		Heavy Duty Miniature Applicator	Die Set for Hand Tool 69710-1 or 626 Pneumatic Tool System	
AWG	mm <sup>2</sup>		Male	Female	Male	Female	Male	Female			
16 and 14-12	1.25-1.4 and 2-3	.135-.160 3.43-4.06	A	66255-1♦	66740-7♦	66255-5♦	1-66740-2♦	66261-1♦	66740-8♦	567455-□***♦	90145-2 <sup>3,7</sup> ♦ and 90145-1 <sup>4,7</sup> ♦
				66256-1 <sup>2</sup> ♦	—	66256-5 <sup>2</sup> ♦	—	66262-1 <sup>2</sup> ♦	—		
			B	66255-2♦	66740-5♦	66255-6♦	1-66740-1♦	66261-2♦	66740-6♦		
				66256-2 <sup>2</sup> ♦	—	66256-4 <sup>2</sup> ♦	—	66262-2 <sup>2</sup> ♦	—		
			C <sup>5</sup>	66255-7♦	66740-1♦	66255-8♦	66740-9♦	66261-4♦	66740-2♦		
				66256-6 <sup>2</sup> ♦	—	66256-7 <sup>2</sup> ♦	—	66262-4 <sup>2</sup> ♦	—		
10	5-6	.190-.220 4.83-5.59	A	66253-1♦	66741-7♦	66253-5♦	1-66741-2♦	66259-1♦	66741-8♦	567021-□***♦	90140-17♦
				66254-1 <sup>2</sup> ♦	—	—	—	66260-1 <sup>2</sup> ♦	—		
			B	66253-2♦	66741-5♦	66253-6♦	1-66741-1♦	66259-2♦	66741-6♦		
				66254-2 <sup>2</sup> ♦	—	66254-5♦	—	66260-2 <sup>2</sup> ♦	—		
			C <sup>5</sup>	66253-4♦	66741-1♦	66253-8♦	66741-9♦	66259-4♦	66741-2♦		
				66254-4 <sup>2</sup> ♦	—	—	—	66260-4 <sup>2</sup> ♦	—		

<sup>1</sup>Wire strip length—.281 [7.14].

<sup>2</sup>Ground contact.

<sup>3</sup>Die insert **Part No. 90145-2** is for crimping 16 AWG [1.25-1.4 mm<sup>2</sup>] wire.

<sup>4</sup>Die insert **Part No. 90145-1** is for crimping 14-12 AWG [2-3 mm<sup>2</sup>] wire.

<sup>5</sup>Recommended for high current/vibration applications where fretting corrosion is a problem.

<sup>7</sup>Die Set requires "C" Head Adapter **Part No. 318161-1**; Adapter Holder **Part No. 356304-1** (with ratchet) or **189928-1** (without); and Power Unit **Part No. 189721-2** (hand actuated) or **189722-2** (foot actuated).

Extraction Tool Part No. 91019-3

\*\*There are power options available for these tools/dies. See Battery Powered Crimp tool Kit and SDE Electric Terminator on page 30.

\*\*\*Call Technical Support at 1-800-522-6752 for Automatic Machine Applicator Part Numbers.

**Note:** All part numbers are RoHS compliant except: ♦ Indicates non-RoHS compliant.

**Power Contacts—High Current Upgrade** (Continued)

**Type XII, Screw Machined**

The features of the High Current Type XII contact have been designed to fit into the existing AMP Multimate Connectors such as CPC (Circular Plastic Connector), CMC (Circular Metal Connector), G Series, and M Series housings. An initial T-Rise test in free air has shown a 60 amp capability with a 30°C T-Rise with 8 gage wires. The contact may be crimped onto 8 AWG wire with a Daniels Hand Tool M310 or AMP P/N 356114-1 and Positioner TP1068S or AMP P/N 356119-1.

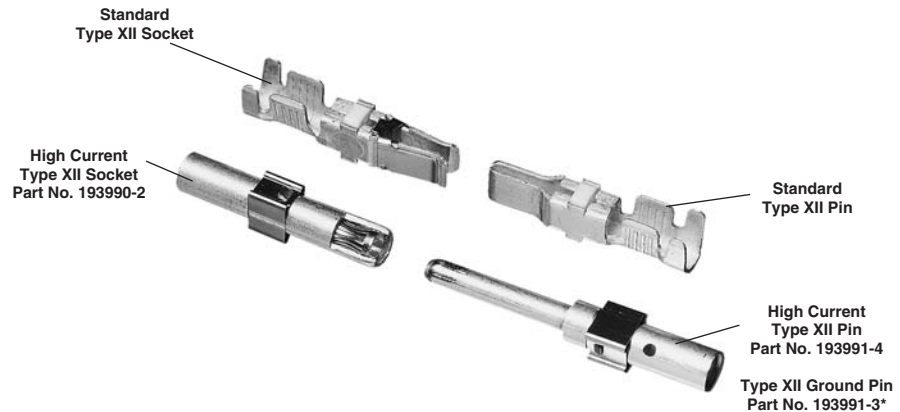

\* Not recommended for CPC connectors.

**Cable-to-Cable**

**Material**

**Body** — Copper Alloy

**Louvertac Band** — Beryllium Copper

**Retention Spring** — Stainless Steel

**Finish**

**Body** — Silver

**Louvertac Band** — Gold



**Extraction Tool Part No. 224155-1**

**Current-Carrying Capacity.** The graph shows current-carrying capacity versus temperature rise for a fully energized 3 position CPC plug P/N 206037-2 and receptacle P/N 206036-2. These initial representative amperage ratings were conducted with 8 AWG wires that were 3 feet long.

■ **Recognized under the Component Program of Underwriters Laboratories Inc.,**  **File No. E28476**

**Current Rating for 30°C Temperature Rise 100% Energized**

**3 Circuit Connector (Wire-to-Wire)**

**TEMPERATURE RISE VS CURRENT**

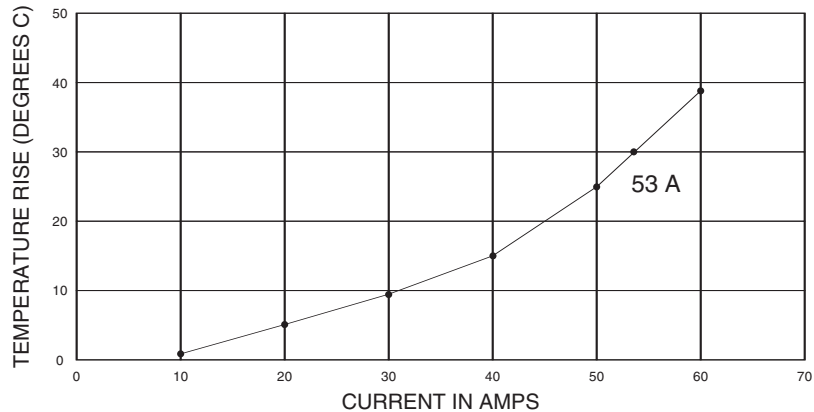

**Plug**  
(For Sockets)



**Square Flange Receptacle**  
(For Pins)

**Notes: 1. High Current contacts with Louvertac bands are NOT intermateable with any other contact.**

2. Additional information on CPC and CMC connectors is available in Catalog 82021.

3. Additional information on G Series connectors is available in Catalog 82046.

4. Additional information on M Series connectors is available in Catalog 82003.

5. Additional information on LGH connectors is available in Catalog 82024.

**Note:** All part numbers are RoHS compliant.



**Стандарт  
Электрон  
Связь**

Мы молодая и активно развивающаяся компания в области поставок электронных компонентов. Мы поставляем электронные компоненты отечественного и импортного производства напрямую от производителей и с крупнейших складов мира.

Благодаря сотрудничеству с мировыми поставщиками мы осуществляем комплексные и плановые поставки широчайшего спектра электронных компонентов.

Собственная эффективная логистика и склад в обеспечивает надежную поставку продукции в точно указанные сроки по всей России.

Мы осуществляем техническую поддержку нашим клиентам и предпродажную проверку качества продукции. На все поставляемые продукты мы предоставляем гарантию .

Осуществляем поставки продукции под контролем ВП МО РФ на предприятия военно-промышленного комплекса России , а также работаем в рамках 275 ФЗ с открытием отдельных счетов в уполномоченном банке. Система менеджмента качества компании соответствует требованиям ГОСТ ISO 9001.

Минимальные сроки поставки, гибкие цены, неограниченный ассортимент и индивидуальный подход к клиентам являются основой для выстраивания долгосрочного и эффективного сотрудничества с предприятиями радиоэлектронной промышленности, предприятиями ВПК и научно-исследовательскими институтами России.

С нами вы становитесь еще успешнее!

**Наши контакты:**

**Телефон:** +7 812 627 14 35

**Электронная почта:** [sales@st-electron.ru](mailto:sales@st-electron.ru)

**Адрес:** 198099, Санкт-Петербург,  
Промышленная ул, дом № 19, литера Н,  
помещение 100-Н Офис 331