

Medium Voltage Fuses

2400 - 25,500 VAC ■ Current Limiting



Littelfuse now offers a complete selection of “E” and “R” rated medium voltage fuses for the protection of transformers, potential transformers, feeders, and motor circuits. Single, double, and triple barrel designs are available to cover a wide range of current, voltage, and interrupting ratings. Conventional ferrule type, clip lock, and bolt-in mounting configurations are now available for virtually any application. Hermetically sealed fuses for use in hazardous environments are also offered.

Contact the factory or your local Littelfuse representative for additional fuse ratings or custom mounting configurations.

24 Hour Emergency Service is available.

Call 1-800-227-0029.

APPLICATIONS

- Power Transformer Protection
- Potential Transformer Protection
- Motor Controller Back-up Protection
- Fused Switches
- Feeder Circuits



Current limiting “E” and “R” rated fuses are equipped with a mechanical indicator or striker pin that protrudes through the fuse cap upon operation of the fuse. This provides visual identification of a blown fuse and can be used as a trigger for external devices.

GENERAL INFORMATION

The terms “Medium Voltage” and “high voltage” have been used interchangeably by many people to describe fuses operating above 600 volts. Technically speaking, “medium voltage” fuses are those intended for the voltage range from 2,400 to 38,000 VAC. “High voltage fuses are for circuits carrying voltages greater than 38,000 VAC.

“E” Rated fuses are considered to be general purpose fuses and can be used to protect against low and high values of fault current. “R” rated fuses are designed for back-up protection. They must be used in series with other devices, such as motor overload relays, in order to achieve both overload and short circuit protection.

Medium voltage fuses are not intended to provide overload protection in the same sense as fuses rated 600 volts or less. Medium voltage fuse current ratings do not have the same meanings as the ampere ratings of low voltage fuses.

All medium voltage fuses are limited in their ability to interrupt low value overcurrents, especially those between 100% and 200% of the fuse's continuous current rating. They are designed to carry their rated current without exceeding the temperature rise permitted by NEMA and ANSI standards.

Additional application data can be found in the Fuse Application section of the POWR-GARD Products catalog (PF101).

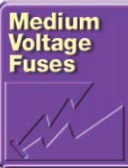

Bolt-in Mount Fuses

R Rated Medium Voltage Fuses

Current Limiting

FEATURES

“R” rated fuses provide required short-circuit protection for medium voltage motors, motor controllers and associated circuitry. These components have limited ability to absorb the energy of large short circuit currents. Medium voltage motor controllers contain overload relays which provide both overload protection and locked rotor protection to the motor. The controllers are also intended to interrupt low value short circuits within the capability of the motor controller. This protects the medium voltage fuse from sustained overcurrents which are less than their minimum interrupting rating.

NEMA Standards for “R” rated medium voltage power fuses require that they operate within 15-35 seconds when subjected to an rms current 100 times the “R” rating. For example, a fuse with a 2R rating will open within 15 to 35 seconds on an applied current of $2 \times 100 = 200$ amperes.

Part Number System

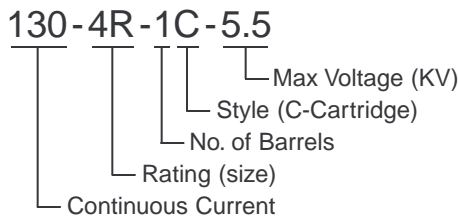

CHARACTERISTICS

Voltage Rating: 2,400 volts – 15,500 volts

Current Range: 2R – 36R

OPTIONS

- Hermitically sealed for use in hazardous locations (add “S” suffix to part number)
- Hookekey attachment (add “W” suffix to part number)
- Bolt-in mounting configurations



Hookekey Feature*

*For hookekey attachment; add “W” suffix to part number

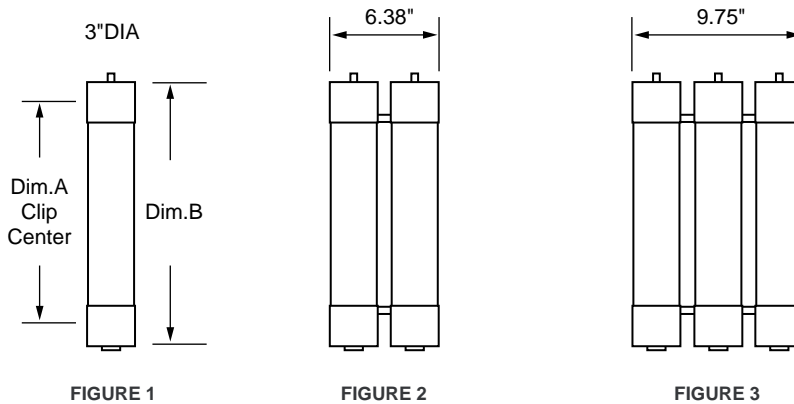
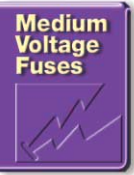

R RATED	Catalog Number	Old Catalog Number	Size	Maximum Continuous Current @ 40 deg C.	Dim. A (inches)	Dim. B (inches)	Minimum Interrupting Rating RMS Amps	Max Interrupting Rating RMS Asym	Figure Number
2.75 KV	70-2R-1C-2.75	LCK 2R	2R	70	7"	10.875"	170	80,000	1
	100-3R-1C-2.75	LCK 3R	3R	100			250	80,000	1
	130-4R-1C-2.75	LCK 4R	4R	130			340	80,000	1
	150-5R-1C-2.75	LCK 5R	5R	150			390	80,000	1
	170-6R-1C-2.75	LCK 6R	6R	170			500	80,000	1
	200-9R-1C-2.75	LCK 9R	9R	200			760	80,000	1
	230-12R-1C-2.75	LCK 12R	12R	230	1000	80,000	1		
	390-18R-2C-2.75	LCK 18R	18R	390	7"	10.875"	1500	80,000	2
	450-24R-2C-2.75	LCK 24R	24R	450			1950	80,000	2

Add “w” suffix to part number for hookekey attachment.

R Rated Medium Voltage Fuses

Current Limiting

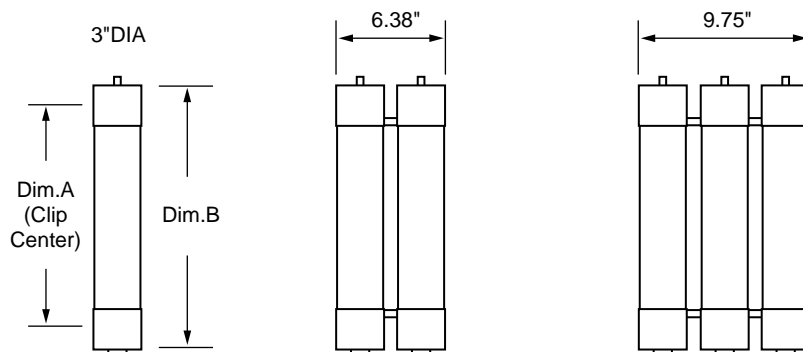

FIGURE 4

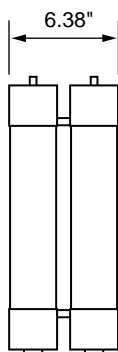

FIGURE 5

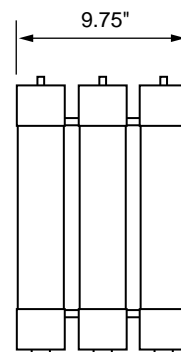
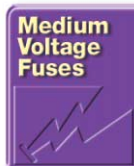

FIGURE 6

R RATED	Catalog Number	Old Catalog Number	Size	Maximum Continuous Current @ 40 deg C.	Dim. A (inches)	Dim. B (inches)	Minimum Interrupting Rating RMS Amps	Max Interrupting Rating RMS (Asym)	Figure Number	
5.5 KV	70-2R-1C-5.5	LCL 2R	2R	70	12"	15.875"	170	80,000	4	
	100-3R-1C-5.5	LCL 3R	3R	100			250	80,000	4	
	130-4R-1C-5.5	LCL 4R	4R	130			340	80,000	4	
	150-5R-1C-5.5	LCL 5R	5R	150			390	80,000	4	
	170-6R-1C-5.5	LCL 6R	6R	170			500	80,000	4	
	200-9R-1C-5.5	LCL 9R	9R	200			760	80,000	4	
	230-12R-1C-5.5	LCL 12R	12R	230	1000	80,000	4			
	390-18R-2C-5.5	LCL 18R	18R	390	12"	15.875"	1500	80,000	5	
	450-24R-2C-5.5	LCL 24R	24R	450			1950	80,000	5	
	480-26R-2C-5.5	—	26R	480			2100	80,000	5	
	550-30R-2C-5.5	—	30R	550			2400	80,000	5	
	600-32R-2C-5.5	—	32R	600			2600	80,000	5	
	650-36R-2C-5.5	—	36R	650	2900	80,000	5			
	550-30R-3C-5.5	—	30R	550	12"	15.875"	2400	80,000	6	
	600-32R-3C-5.5	—	32R	600			2600	80,000	6	
	650-36R-3C-5.5	LCL 36R	36R	650			2900	80,000	6	
	5.5 KV 1.4" Clip Centers	70-2R-1C-5.5X	—	2R	70	14"	17.875"	170	80,000	4
		100-3R-1C-5.5X	—	3R	100			250	80,000	4
130-4R-1C-5.5X		—	4R	130	340			80,000	4	
150-5R-1C-5.5X		—	5R	150	390			80,000	4	
170-6R-1C-5.5X		—	6R	170	500			80,000	4	
200-9R-1C-5.5X		—	9R	200	760			80,000	4	
230-12R-1C-5.5X		—	12R	230	1000	80,000	4			
390-18R-2C-5.5X		—	18R	390	14"	17.875"	1500	80,000	5	
450-24R-2C-5.5X		—	24R	450			1950	80,000	5	



R RATED	Catalog Number	Old Catalog Number	Size	Maximum Continuous Current @ 40 deg C.	Dim. A (inches)	Dim. B (inches)	Minimum Interrupting Rating RMS Amps	Max Interrupting Rating RMS (Asym)	Figure Number
8.25 KV	70-2R-1C-8.25	—	2R	70	12"	15.875"	190	80,000	4
	100-3R-1C-8.25	—	3R	100			225	80,000	4
	130-4R-1C-8.25	—	4R	130			330	80,000	4
	150-5R-1C-8.25	—	5R	150			440	80,000	4
	170-6R-1C-8.25	—	6R	170			500	80,000	4
	200-9R-1C-8.25	—	9R	200			740	80,000	4
	230-12R-1C-8.25	—	12R	230	955	80,000	4		
	390-18R-2C-8.25	—	18R	390	12"	15.875"	1440	80,000	5
	450-24R-2C-8.25	—	24R	450			1910	80,000	5

Add "w" suffix to part number for hooke attachment.

R Rated Medium Voltage Fuses



POWR-GARD™ Products

Current Limiting

Littelfuse's POWR-GARD medium voltage fuses are available in several bolt-in mounting configurations. Contact factory for custom configurations

- “B” Bolt mount
- “BI” Bolt-In mount
- “IB” Inverted-Bolt mount

Refer to illustrations for mounting dimensions.

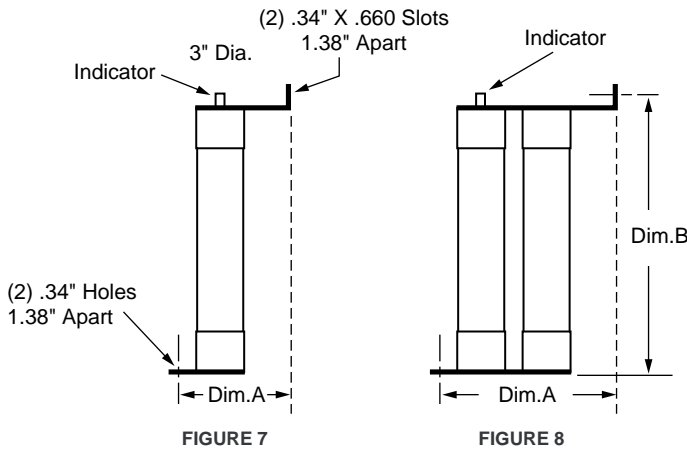
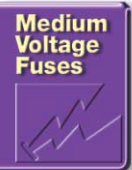

Bolt Mount “B”

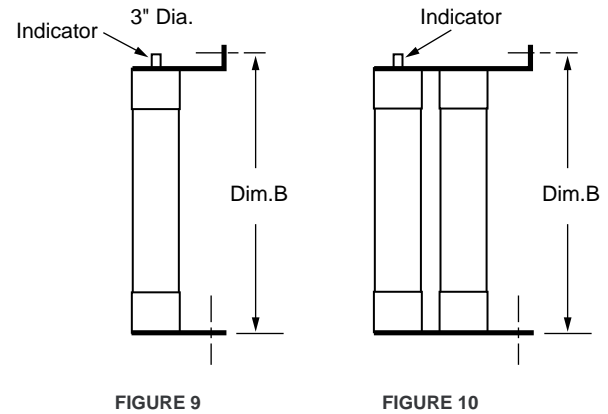

Inverted Bolt “IB”

R RATED	Catalog Number	Old Catalog Number	Size	Maximum Continuous Current @ 40 deg C.	Dim. A (inches)	Dim. B (inches)	Minimum Interrupting Rating RMS Amps	Max Interrupting Rating RMS (Asym)	Figure Number			
2.75 KV Bolt Mount “B”	70-2R-1B-2.75	—	2R	70	4.6"	13"	170	80,000	7			
	100-3R-1B-2.75		3R	100			250	80,000	7			
	130-4R-1B-2.75		4R	130			240	80,000	7			
	150-5R-1B-2.75		5R	150			390	80,000	7			
	170-6R-1B-2.75		6R	170			500	80,000	7			
	200-9R-1B-2.75		9R	200			760	80,000	7			
	230-12R-1B-2.75		12R	230			1000	80,000	7			
	390-18R-2B-2.75	—	18R	390	7.4"	13"	1500	80,000	8			
	450-24R-2B-2.75	—	24R	450	7.4"	13"	1950	80,000	8			
	2.75 KV Inverted Bolt “IB”	70-2R-1IB-2.75	—	2R	70	—	13"	170	80,000	9		
100-3R-1IB-2.75		3R		100	250			80,000	9			
130-4R-1IB-2.75		4R		130	340			80,000	9			
150-5R-1IB-2.75		5R		150	390			80,000	9			
170-6R-1IB-2.75		6R		170	500			80,000	9			
200-9R-1IB-2.75		9R		200	760			80,000	9			
230-12R-1IB-2.75		12R		230	1000			80,000	9			
390-18R-2IB-2.75		—		18R	390			—	13"	1500	80,000	10
450-24R-2IB-2.75		—		24R	450			—	13"	1950	80,000	10

.44" X .91" Slots (1.53" c.t.c.)



Front View

3" Dia. Indicator

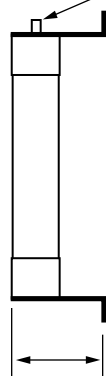

FIGURE 11

Indicator

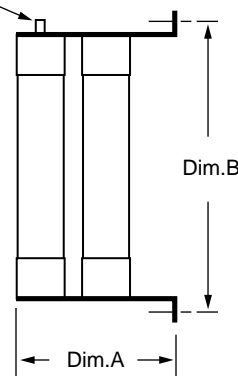

FIGURE 12

Indicator

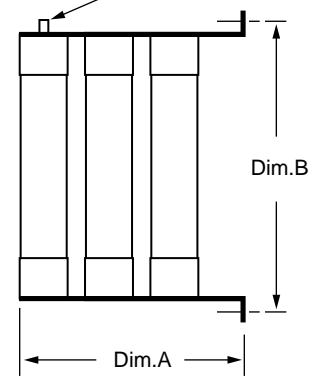
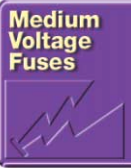

FIGURE 13

Bolt-In Mount "BI"

R RATED	Catalog Number	Old Catalog Number	Size	Maximum Continuous Current @ 40 deg C.	Dim. A (inches)	Dim. B (inches)	Minimum Interrupting Rating RMS Amps	Max Interrupting Rating RMS (Asym)	Figure Number
5.5 KV Bolt In Mount "BI"	70-2R-1BI-5.5		2R	70	3.6	18"	170	80,000	11
	100-3R-1BI-5.5		3R	100			250	80,000	11
	130-4R-1BI-5.5		4R	130			340	80,000	11
	150-5R-1BI-5.5	—	5R	150			390	80,000	11
	170-6R-1BI-5.5		6R	170			500	80,000	11
	200-9R-1BI-5.5		9R	200			760	80,000	11
	230-12R-1BI-5.5		12R	230	1000	80,000	11		
	390-18R-2BI-5.5		18R	390	7.6	18"	1500	80,000	12
	450-24R-2BI-5.5		24R	450			1950	80,000	12
	480-26R-2BI-5.5	—	26R	480			2200	80,000	12
	550-30R-2BI-5.5		30R	550			2400	80,000	12
	600-32R-2BI-5.5		32R	600			2650	80,000	12
	650-36R-2BI-5.5		36R	650	2900	80,000	12		
	550-30R-3BI-5.5		30R	550	18"	18"		80,000	13
600-32R-3BI-5.5	—	32R	600	80,000			13		
650-36R-3BI-5.5		36R	650	80,000			13		
700-38R-3BI-5.5		38R	700	80,000			13		
5.5 KV Bolt Mount "B"	70-2R-1B-5.5		2R	70	4.6	18"	170	80,000	7
	100-3R-1B-5.5		3R	100			250	80,000	7
	130-4R-1B-5.5		4R	130			340	80,000	7
	150-5R-1B-5.5	—	5R	150			390	80,000	7
	170-6R-1B-5.5		6R	170			500	80,000	7
	200-9R-1B-5.5		9R	200			760	80,000	7
	230-12R-1B-5.5		12R	230	1000	80,000	7		
	390-18R-2B-5.5		18R	390	7.4	18"	1500	80,000	8
	450-24R-2B-5.5		24R	450			1950	80,000	8
	550-30R-2B-5.5	—	30R	550			2400	80,000	8
600-32R-2B-5.5		32R	600	2650			80,000	8	
650-36R-2B-5.5		36R	650	2900	80,000	8			
5.5 KV Inverted Bolt "IB"	70-2R-1IB-5.5		2R	70	—	18"	170	80,000	9
	100-3R-1IB-5.5		3R	100			250	80,000	9
	130-4R-1IB-5.5		4R	130			340	80,000	9
	150-5R-1IB-5.5	—	5R	150			390	80,000	9
	170-6R-1IB-5.5		6R	170			500	80,000	9
	200-9R-1IB-5.5		9R	200			760	80,000	9
	230-12R-1IB-5.5		12R	230	1000	80,000	9		
	390-18R-2IB-5.5		18R	390	—	18"	1500	80,000	10
	450-24R-2IB-5.5		24R	450			1950	80,000	10
	550-30R-2IB-5.5	—	30R	550			2400	80,000	10
600-32R-2IB-5.5		32R	600	2650			80,000	10	
650-36R-2IB-5.5		36R	650	2900	80,000	10			
8.25 KV Bolt-In Mount "BI"	70-2R-1BI-8.25		2R	70	3.6	18"	190	80,000	11
	100-3R-1BI-8.25		3R	100			225	80,000	11
	130-4R-1BI-8.25		4R	130			330	80,000	11
	150-5R-1BI-8.25	—	5R	150			400	80,000	11
	170-6R-1BI-8.25		6R	170			500	80,000	11
	200-9R-1BI-8.25		9R	200			740	80,000	11
	230-12R-1BI-8.25		12R	230	955	80,000	11		
	390-18R-2BI-8.25		18R	390	7.6	18"	1440	80,000	12
450-24R-2BI-8.25	—	24R	450	1910			80,000	12	



E Rated Medium Voltage Fuses

Current Limiting

“E” Rated fuses have time current characteristics designed to provide current limiting protection for power transformers, potential transformers, power centers, feeder centers, and unit sub stations. When properly applied, they can protect against high and low value fault currents.

NEMA Standards for “E” rated medium voltage fuses require that fuses rated 100E or less open within 300 seconds (5 minutes) when subjected to an RMS value of 200-240% of the fuse’s continuous current rating; and fuses with an “E” rating larger than 100E must open within 600 seconds (10 minutes) when subjected to an rms current of 220-240% of the fuse’s continuous current rating. These values establish one point on the time-current curve.

Application Note:

Since these fuses are used for the protection of general purpose circuits which may contain transformers, motors, and other equipment producing inrush and/or overload currents, fuses should generally be rated at 140% of the normal full load current, and circuits should be analyzed to ensure that system load currents will not exceed the current rating of the fuse.

CHARACTERISTICS

Voltage Rating: 2,400 volts – 38,000 volts

Current Range: 10E – 600E

OPTIONS

- Hermetically Sealed for use in hazardous locations (add “S” suffix to part number)
- Clip-lock (CL) and bolt-in styles available.

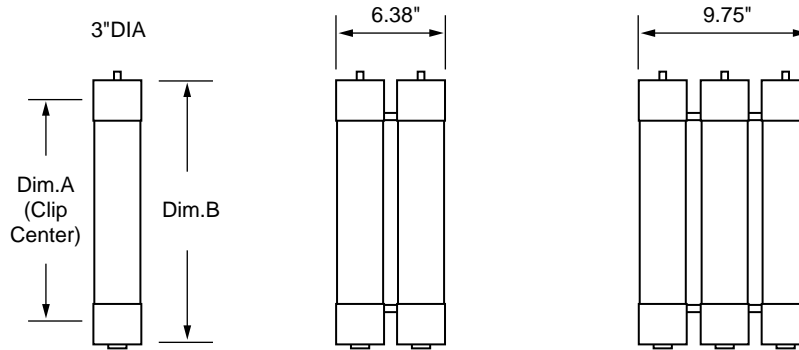
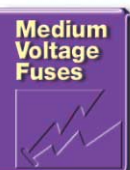

FIGURE 14

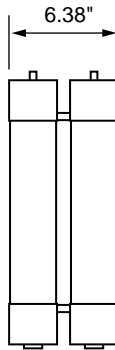

FIGURE 15

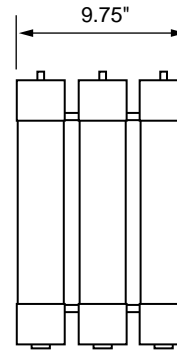

FIGURE 16

RATED	Catalog Number	Old Catalog Number	Size	Dim. A (inches)	Dim. B (inches)	Max Interrupting Rating RMS (Asym)	Figure Number
2.75 Max. KV	10E-1C-2.75	LCX 10E	10E	7"	10.875"	80,000	14
	15E-1C-2.75	—	15E				14
	20E-1C-2.75	—	20E				14
	25E-1C-2.75	—	25E				14
	30E-1C-2.75	LCX 30E	30E				14
	40E-1C-2.75	LCX 40E	40E				14
	50E-1C-2.75	LCX 50E	50E				14
	65E-1C-2.75	LCX 65E	65E				14
	80E-1C-2.75	LCX 80E	80E				14
	100E-1C-2.75	LCX 100E	100E				14
	125E-1C-2.75	—	125E				14
	150E-1C-2.75	—	150E				14
	200E-1C-2.75	—	200E				14
	125E-2C-2.75	LCX 125E	125E				7"
	150E-2C-2.75	LCX 150E	150E	15			
	175E-2C-2.75	LCX 175E	175E	15			
	200E-2C-2.75	LCX 200E	200E	15			
	225E-2C-2.75	—	225E	15			
	250E-2C-2.75	LCX 250E	250E	15			
	300E-2C-2.75	LCX 300E	300E	15			
	350E-2C-2.75	—	350E	15			
	400E-2C-2.75	LCX 400E	400E	15			
450E-2C-2.75	—	450E	15				

E Rated Medium Voltage Fuses

Current Limiting

E RATED	Catalog Number	Old Catalog Number	Size	Dim. A (inches)	Dim. B (inches)	Max Interrupting Rating RMS (Asym)	Diagram				
5.5 Max. KV	10E-1C-5.5	—	10E	12"	15.875"	80,000	14				
	15E-1C-5.5	—	15E				14				
	20E-1C-5.5	—	20E				14				
	25E-1C-5.5	—	25E				14				
	30E-1C-5.5	LCY 30E	30E				14				
	40E-1C-5.5	LCY 40E	40E				14				
	50E-1C-5.5	LCY 50E	50E				14				
	65E-1C-5.5	LCY 60E	65E				14				
	80E-1C-5.5	LCY 80E	80E				14				
	100E-1C-5.5	LCY 100E	100E				14				
	125E-1C-5.5	LCY 125E	125E				14				
	150E-1C-5.5	LCY 150E	150E				14				
	175E-1C-5.5	LCY 175E	175E	14							
	200E-1C-5.5	LCY 200E	200E	14							
	125E-2C-5.5	—	125E	12"	15.875"	80,000	15				
	150E-2C-5.5	—	150E				15				
	175E-2C-5.5	—	175E				15				
	200E-2C-5.5	—	200E				15				
	250E-2C-5.5	LCY 250E	250E				15				
	300E-2C-5.5	LCY 300E	300E				15				
	350E-2C-5.5	LCY 350E	350E				15				
	400E-2C-5.5	LCY 400E	400E	15							
	450E-2C-5.5	LCY 450E	450E	15							
	500E-3C-5.5	—	500E	12"	15.875"	80,000	16				
	550E-3C-5.5	—	550E				16				
	600E-3C-5.5	—	660E				16				
	5.5 Max. KV	5NLE-10E	LCU 30E	10E	14	17-7/8"	80,000	14			
		5NLE-15E		15E				14			
5NLE-20E		20E		14							
5NLE-25E		25E		14							
5NLE-30E		30E		14							
5NLE-40E		LCU 40E		40E				14			
5NLE-50E		LCU 50E		50E				14			
5NLE-65E		LCU 65E		65E				14			
5NLE-80E		LCU 80E		80E				14			
5NLE-100E		LCU 100E		100E				14			
5NLE-125E		LCU 125E		125E				14			
5NLE-150E		LCU 150E		150E				14			
5NLE-175E		LCU 175E		175E				14			
5NLE-200E		LCU 200E		200E				14			
5NLE2-225E		LCU 250E		225E				14"	17-7/8"	80,000	15
5NLE2-250E				250E							15
5NLE2-300E			LCU 300E	300E	15						
5NLE2-350E			LCU 350E	350E	15						
5NLE2-400E			LCU 400E	400E	15						
5NLE2-450E			LCU 450E	450E	15						

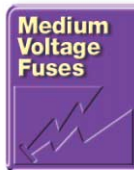

E Rated Medium Voltage Fuses

Current Limiting

E RATED	Catalog Number	Old Catalog Number	Size	Dim. A (inches)	Dim. B (inches)	Max Interrupting Rating RMS (Asym)	Diagram			
8.25 Max. KV	10E-1C-8.25		10E	12"	15-7/8"	80,000	14			
	15E-1C-8.25		15E				14			
	20E-1C-8.25		20E				14			
	25E-1C-8.25		25E				14			
	30E-1C-8.25	LDZ 30E	30E				14			
	40E-1C-8.25	LDZ 40E	40E				14			
	50E-1C-8.25	LDZ 50E	50E				14			
	65E-1C-8.25	LDZ 65E	65E				14			
	80E-1C-8.25	LDZ 80E	80E				14			
	100E-1C-8.25	LDZ 100E	100E				14			
	125E-1C-8.25	LDZ 125E	125E				14			
	150E-1C-8.25	LDZ 150E	150E				14			
	125E-2C-8.25	LDZ 125E	125E				12"	15-7/8"	80,000	15
	150E-2C-8.25	LDZ 150E	150E							15
	200E-2C-8.25	LDZ 200E	200E							15
250E-2C-8.25	LDZ 250E	250E	15							
300E-2C-8.25	LDZ 300E	300E	15							
350E-3C-8.25	LDZ 350Z	350E	12"	15-7/8"	80,000	16				
400E-3C-8.25		400E				16				

8.25 Max. KV	8NLE-10E		10E	14"	17-7/8"	80,000	14			
	8NLE-15E		15E				14			
	8NLE-20E		20E				14			
	8NLE-25E		25E				14			
	8NLE-30E	LCZ 30E	30E				14			
	8NLE-40E	LCZ 40E	40E				14			
	8NLE-50E	LCZ 50E	50E				14			
	8NLE-65E	LCZ 65E	65E				14			
	8NLE-80E	LCZ 80E	80E				14			
	8NLE-100E	LCZ 100E	100E				14			
	8NLE2-100E	LCZ 100E	100E				14"	17-7/8"	80,000	15
	8NLE2-125E	LCZ 125E	125E							15
	8NLE2-150E	LCZ 150E	150E							15
	8NLE2-200E	LCZ 200E	200E							15
	8NLE2-250E		250E							15

E RATED	Catalog Number	Old Catalog Number	Size	Dim. A (inches)	Dim. B (inches)	Max Interrupting Rating RMS (Asym)	Figure Number
15.5 Max. KV	10E-1C-15.5	LDN 10E	10E	15"	18.875"	60,000	14
	15E-1C-15.5	LDN 15E	15E				14
	20E-1C-15.5	LDN 20E	20E				14
	25E-1C-15.5	LDN 25E	25E				14
	30E-1C-15.5	LDN 30E	30E				14
	40E-1C-15.5	LDN 40E	40E				14
	50E-1C-15.5	LDN 50E	50E				14
	65E-1C-15.5	LDN 65E	65E				14
	80E-1C-15.5	LDN 80E	80E				14
	100E-1C-15.5	LDN 100E	100E				14
	65E-2C-15.5		65E	15"	18.875"	60,000	15
	80E-2C-15.5		80E				15
	100E-2C-15.5		100E				15
	125E-2C-15.5	LDN 150E	125E				15
	150E-2C-15.5	LDN 175E	150E				15
	175E-2C-15.5		175E	15			
	200E-2C-15.5		200E	15			
	200E-3C-15.5		200E	15"	18.875"	60,000	16
	250E-3C-15.5		250E				16
	300E-3C-15.5		300E				16

E Rated Medium Voltage Fuses

Current Limiting

RATED	Catalog Number	Old Catalog Number	Size	Dim. A (inches)	Dim. B (inches)	Max Interrupting Rating RMS (Asym)	Figure Number				
15.5 Max. KV	15GSE-65E	—	65E	18"	21-7/8"	60,000	14				
	15GSE-80E		80E				14				
	15GSE-100E		100E				14				
	15GSE2-125E	—	125E	18"	21-7/8"	60,000	15				
	15GSE2-150E		150E				15				
	15GSE2-175E		175E				15				
15GSE2-200E	200E		15								
15.5 Max. KV	15NLE-10E	LCN 30E LCN 40E LCN 50E LCN 65E LCN 80ES LCN 100ES	10E	20"	23-7/8"	60,000	14				
	15NLE-15E		15E				14				
	15NLE-20E		20E				14				
	15NLE-25E		25E				14				
	15NLE-30E		30E				14				
	15NLE-40E		40E				14				
	15NLE-50E		50E				14				
	15NLE-65E		65E				14				
	15NLE-80E		80E				14				
	15NLE-100E		100E				14				
	15NLE2-80E		LCN 80E				80E	20"	23-7/8"	60,000	15
	15NLE2-100E		LCN 100E				100E				15
	15NLE2-125E	LCN 125X	125E	15							
	15NLE2-150E	LCN 150E	150E	15							
	15NLE2-175E	175E	15								
	15NLE2-200E	LCN 200ED	200E	15							
	15NLE3-150E	—	150E	20"	23-7/8"	60,000	16				
	15NLE3-175E		175E				16				
15NLE3-250E	250E		16								
15NLE3-300E	300E		16								

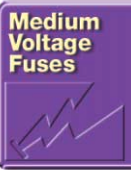

RATED	Catalog Number	Old Catalog Number	Size	Dim. A (inches)	Dim. B (inches)	Max Interrupting Rating RMS (Asym)	Figure Number
25.8 Max. KV	15E-1C-25.8	—	15E	21"	24-5/8"	40,000	14
	20E-1C-25.8		20E				14
	25E-1C-25.8		25E				14
	30E-1C-25.8		30E				14
	40E-1C-25.8		40E				14
	50E-1C-25.8		50E				14
	65E-2C-25.8	—	65E	21"	24-5/8"	40,000	15
	80E-2C-25.8		80E				15
	100E-2C-25.8		100E				15

RATED	Catalog Number	Old Catalog Number	Size	Dim. A (inches)	Dim. B (inches)	Max Interrupting Rating RMS (Asym)	Figure Number				
38 Max. KV	3E-1C-38.0	—	3E	27"	30-5/8"	20,000	14				
	7E-1C-38.0		7E				14				
	10E-1C-38.0		10E				14				
	15E-1C-38.0		15E				14				
	20E-1C-38.0		20E				14				
	25E-1C-38.0		25E				14				
	30E-1C-38.0		30E				14				
	40E-1C-38.0		40E				14				
	50E-2C-38.0		—				50E	27"	30-5/8"	20,000	15
	65E-2C-38.0						65E				15
	80E-2C-38.0	80E		15							

E Rated Medium Voltage Fuses



Current Limiting

POWR-GARD™ Products

Clip Lock Design

The clip lock type design ensures a positive contact between the fuse and the connection cam. The fuse's clip lock tab slides in between the clip casting and the cam to prevent the fuse from slipping or blowing out of the holder. This positive contact improves heat dissipation and allows fuses to run cooler.

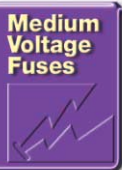
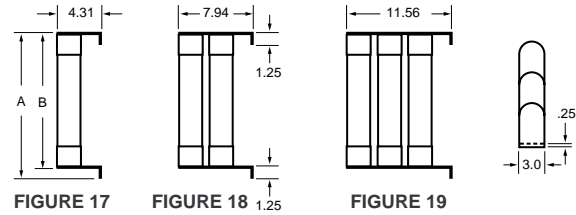

RATED	Catalog Number	Old Catalog Number	Size	Dim. A (inches)	Dim. B (inches)	Max Interrupting Rating RMS (Asym)	Figure Number				
5.5 Max. KV Clip Lock	10E-1CL-5.5	—	10E	16.38"	15.13"	80,000	17				
	15E-1CL-5.5		15E				17				
	20E-1C-5.5		20E				17				
	25E-1CL-5.5		25E				17				
	30E-1CL-5.5		30E				17				
	40E-1CL-5.5		40E				17				
	50E-1CL-5.5		50E				17				
	65E-1CL-5.5		65E				17				
	80E-1CL-5.5		80E				17				
	100E-1CL-5.5		100E				17				
	125E-1CL-5.5		125E				17				
	150E-1CL-5.5		150E				17				
	225E-2CL-5.5		—				225E	17.38"	16.13"	80,000	18
	250E-2CL-5.5						250E				18
	300E-2CL-5.5						300E				18
	350E-2CL-5.5	350E		18							
	400E-2CL-5.5	400E		18							
	450E-2CL-5.5	450E	18								
500E-3CL-5.5	—	500E	17.38"	16.13"	80,000	19					
550E-3CL-5.5		550E				19					
600E-3CL-5.5		600E				19					

RATED	Catalog Number	Old Catalog Number	Size	Dim. A (inches)	Dim. B (inches)	Max Interrupting Rating RMS (Asym)	Figure Number
8.25 Max. KV Clip Lock	10E-1CL-8.25	—	10E	17.38"	16.13"	80,000	17
	15E-1CL-8.25		15E				17
	20E-1C-8.25		20E				17
	25E-1CL-8.25		25E				17
	30E-1CL-8.25		30E				17
	40E-1CL-8.25		40E				17
	50E-1CL-8.25		50E				17
	65E-1CL-8.25		65E				17
	80E-1CL-8.25		80E				17
	100E-1CL-8.25		100E				17
	125E-2CL-8.25	—	125E	17.38"	16.13"	80,000	18
	150E-2CL-8.25		150E				18
	175E-2CL-8.25		175E				18
	200E-2CL-8.25		200E				18
	225E-2CL-8.25		225E				18
	250E-2CL-8.25		250E				18
	300E-2CL-8.25		300E				18
	350E-3CL-8.25		350E				19

RATED	Catalog Number	Old Catalog Number	Size	Dim. A (inches)	Dim. B (inches)	Max Interrupting Rating RMS (Asym)	Figure Number
15.5 Max. KV Clip Lock	10E-1CL-15.5	—	10E	19.8"	18.1"	60,000	17
	15E-1CL-15.5		15E				17
	20E-1CL-15.5		20E				17
	25E-1CL-15.5		25E				17
	30E-1CL-15.5		30E				17
	40E-1CL-15.5		40E				17
	50E-1CL-15.5		50E				17
	65E-1CL-15.5	—	65E	22.81"	21.13"	60,000	17
	80E-1CL-15.5		80E				17
	100E-1CL-15.5		100E				17
	125E-2CL-15.5	—	125	22.81"	19.1"	60,000	18
	150E-3CL-15.5		150E				19
	175E-3CL-15.5	—	175E	22.81"	19.1"	60,000	19
	200E-3CL-15.5		200E				19
	225E-3CL-15.5		225E				19
250E-3CL-15.5	250E		19				
300E-3CL-15.5	300E		19				

E Rated Potential Transformer Fuses

Current Limiting

Potential Transformer (PT) fuses are current limiting fuses with high interrupting ratings designed for the protection of potential transformers.

Application Note:

When applying fuses for the protection of transformers, the magnetizing current inrush must be considered. The characteristics of the inrush, which can be matched with a fuse's time-current curve, should be available from the transformer manufacturer.

CHARACTERISTICS

Voltage Rating: 600VAC – 25,500 VAC
Current Range: 1/2E – 10E

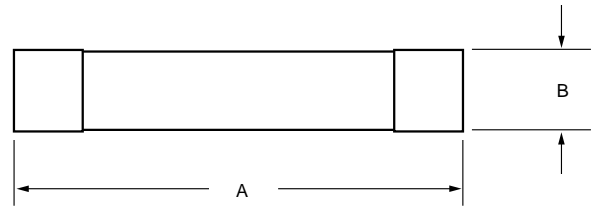

PT	Catalog Number	Old Catalog Number	Size	Length Dim. A (inches)	Diameter Dim. B (inches)	Max Interrupting Rating RMS (Asym)
600 Volt	3E-4PT-6		3E	4.625	0.8125	62,500
	5E-4PT-6		5E	4.625	0.8125	62,500
	7E-4PT-6		7E	4.625	0.8125	62,500
	10E-4PT-6		10E	4.625	0.8125	62,500
2.4 Max. KV	1E-4PT-2.4	LCD 1E-4	1E	4.625	0.8125	40,000
	2E-4PT-2.4	LCD 2E-4	2E	4.625	0.8125	40,000
2.75 Max. KV	1E-6PT-2.75		1E	7.375	1.625	37,500
	2E-6PT-2.75		2E	7.375	1.625	37,500
	3E-6PT-2.75		3E	7.375	1.625	37,500
2.75 Max. KV	1E-8PT-2.75		1E	9.5	1.625	50,000
	2E-8PT-2.75		2E	9.5	1.625	50,000
	3E-8PT-2.75		3E	9.5	1.625	50,000
4.8 Max. KV	1E-5PT-4.8	LCE 1E-4	1E	5.5	0.8125	50,000
	2E-5PT-4.8	LCE 2E-4	2E	5.5	0.8125	50,000
5.5 Max. KV	1/2E-6PT-5.5		1/2E	7.375	1.625	37,500
	1E-6PT-5.5		1E	7.375	1.625	37,500
	2E-6PT-5.5		2E	7.375	1.625	37,500
	3E-6PT-5.5		3E	7.375	1.625	37,500
	5E-6PT-5.5		5E	7.375	1.625	37,500
	1/2E-8PT-5.5	LCQ .5E	1/2E	9.5	1.625	37,500
	1E-8PT-5.5	LCQ 1E	1E	9.5	1.625	37,500
	2E-8PT-5.5	LCQ 2E	2E	9.5	1.625	37,500
	3E-8PT-5.5	LCQ 3E	3E	9.5	1.625	37,500
	5E-8PT-5.5	LCQ 5E	5E	9.5	1.625	37,500
10E-8PT-5.5	LCQ 10E	10E	9.5	1.625	37,500	
8.25 Max. KV	1/2E-8PT-8.25		1/2E	9.5	1.625	50,000
	1E-8PT-8.25		1E	9.5	1.625	50,000
	2E-8PT-8.25		2E	9.5	1.625	50,000
	3E-8PT-8.25		3E	9.5	1.625	50,000
15.5 Max. KV	1/2E-11PT-15.5	LCT .5E	1/2E	12.875	1.625	80,000
	1E-11PT-15.5	LCT 1E	1E	12.875	1.625	80,000
	2E-11PT-15.5	LCT 2E	2E	12.875	1.625	80,000
	3E-11PT-15.5	LCT 3E	3E	12.875	1.625	80,000
	3E-16PT-15.5		3E	17.5	1.625	80,000
5E-16PT-15.5		5E	17.5	1.625	80,000	
25.5 Max. KV	1/2E-16PT-25.5	LCJ 1E-4	1/2E	17.5	1.625	43,500
	1E-16PT-25.5	LCJ 2E-4	1E	17.5	1.625	43,500

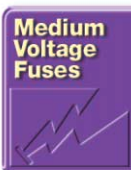



Live parts are available for mounting "E", "R", and "PT" single, double, and triple barrel fuses. Mounting clips are available for ferrule type and clip lock style fuses. All clips are sold in pairs.

Contact factory for additional live parts.

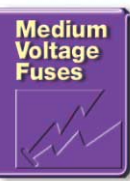

Part Number: 700-500*

For use with all 13/16" diameter PT fuses.

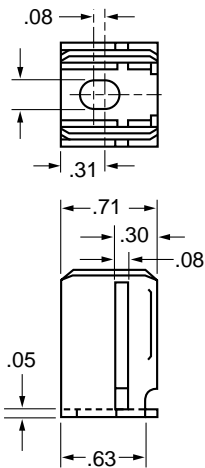

* One Pair

Part Number: 700-530*

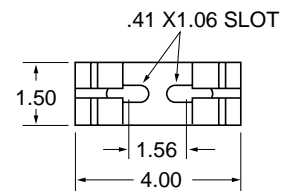

For use with all 3" diameter fuses.

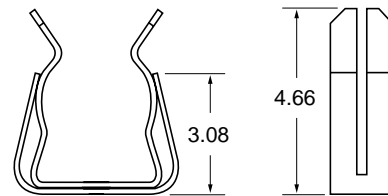

* One Pair

Part Number: 700-520-CL*

Clip Lock Design (For CL-14)

Mounting Details for Clip Lock

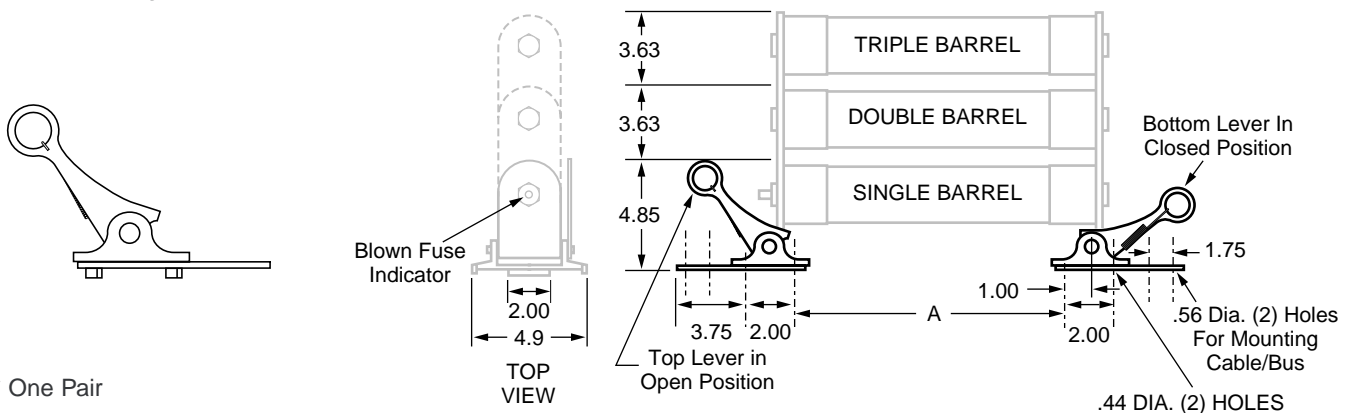

* One Pair



Стандарт Электрон Связь

Мы молодая и активно развивающаяся компания в области поставок электронных компонентов. Мы поставляем электронные компоненты отечественного и импортного производства напрямую от производителей и с крупнейших складов мира.

Благодаря сотрудничеству с мировыми поставщиками мы осуществляем комплексные и плановые поставки широчайшего спектра электронных компонентов.

Собственная эффективная логистика и склад в обеспечивает надежную поставку продукции в точно указанные сроки по всей России.

Мы осуществляем техническую поддержку нашим клиентам и предпродажную проверку качества продукции. На все поставляемые продукты мы предоставляем гарантию .

Осуществляем поставки продукции под контролем ВП МО РФ на предприятия военно-промышленного комплекса России , а также работаем в рамках 275 ФЗ с открытием отдельных счетов в уполномоченном банке. Система менеджмента качества компании соответствует требованиям ГОСТ ISO 9001.

Минимальные сроки поставки, гибкие цены, неограниченный ассортимент и индивидуальный подход к клиентам являются основой для выстраивания долгосрочного и эффективного сотрудничества с предприятиями радиоэлектронной промышленности, предприятиями ВПК и научно-исследовательскими институтами России.

С нами вы становитесь еще успешнее!

Наши контакты:

Телефон: +7 812 627 14 35

Электронная почта: sales@st-electron.ru

Адрес: 198099, Санкт-Петербург,
Промышленная ул, дом № 19, литера Н,
помещение 100-Н Офис 331