



DESCRIPTION

The LX27901 is an extremely versatile high-performance controller for driving LEDs from the HVDC (output) rail of a standard PFC front-end.

The controller allows the user to utilize three different converter drive schemes, LLC (resonant), conventional PWM control, and Microsemi's proprietary synchronous scheme, all selectable by the multi-function ENABLE pin.

In non-resonant mode, the controller provides two 180° phase-shifted pulse-width modulated drive signals for implementing various two-switch DC-DC converter topologies, such a half-bridge and asymmetrical forward converter. It can also be used for one-switch topologies.

Direct PWM input dimming operation can be realized by inputting a suitable dimming pulse train to the DIM pin. The LX27901 supports analog LED current control utilizing the BRTA pin for setting the analog LED current.

In addition, a proprietary dimming algorithm ACU_BRITE® is incorporated. The controller integrates the pulsed LED current and compares it with a reference for very accurate brightness control irrespective of duty cycle.

The LX27901 is designed to operate with Microsemi's proprietary lossless (magnetic) current balancing schemes.

The controller also provides a proprietary synchronous regulation function to allow the user to control the LED current and dimming from an unregulated switching power supply source, to minimize the number of power conversion stages and the associated losses and component costs.

A versatile set of system monitoring and protection functions are incorporated in the LX27901 design to provide reliable protection of the device and the system. These can account for shorted and open LED strings for example.

Three input pins, ISNS, VSNS and UVS/SYN are assigned to support regulation and protection. A dedicated fault indication pin allows the user to generate a direct fault report to the system and configure addition protection features with simple external circuits.

The device is available in 16 lead SOIC surface mount package in the industrial temperature range.

Refer to the Application Note titled *"Some Proprietary LED Current Balancing Techniques"*.

KEY FEATURES

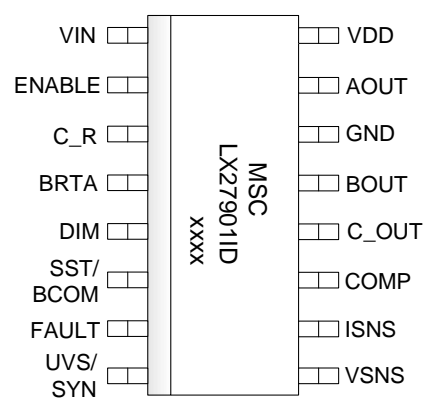
- LLC, PWM and proprietary synchronous modes to drive the LED strings
- LED strings can be dimmed by PWM or analog methods
- Proprietary algorithm to provide accurate brightness control at high efficiency over wide dimming duty cycle range
- Accurate parallel LED strings current matching using Microsemi's patented non-dissipative current-balancing technology
- Robust protection from open or shorted LED conditions
- Dedicated fault indication
- 0.8A Source & Sink Drive Capability
- On Chip 5.25V Regulator
- Direct connection to input voltage rail up to 27V
- LLC max operating frequency to 1 MHz, PWM to 150 kHz
- Synchronous regulation function to minimize power conversion stage
- RoHS compliant & halogen Free

APPLICATIONS

- LCD LED Backlight TV
- LCD LED Backlight Monitors
- Other LED Backlight Systems

IMPORTANT: For the most current data, consult MICROSEMI's website: <http://www.microsemi.com>

PACKAGE ORDER INFO		THERMAL DATA
T_A (°C)	D Plastic SOIC 16 Pin	$\theta_{JA} = 82.2$ °C/W
	RoHS Compliant / Pb-free	THERMAL RESISTANCE-JUNCTION TO AMBIENT
-40 to +85	LX27901ID	Junction Temperature Calculation: $T_J = T_A + (P_D \times \theta_{JA})$. The θ_{JA} numbers are guidelines for the thermal performance of the device/pc-board system. All of the above assume no ambient airflow. θ_{JA} number above is with 4-layer pcb board.
Note: Available in Tape & Reel. Append the letters "TR" to the part number. (i.e. LX27901ID-TR)		

ABSOLUTE MAXIMUM RATINGS	PACKAGE PIN OUT
Supply Input Voltage, VIN0.3V to 36V Signal Outputs, VDD, AOUT, BOUT, C_OUT.....-0.3V to 6.5V Signal Inputs, C_R, BRTA-0.3V to VDD+0.3V Signal Inputs, ENABLE, DIM, ISNS, VSNS, UVS/SYN-0.3V to VDD+0.3V Signal Outputs COMP, SST/BCOM, FAULT-0.3V to VDD Maximum Junction Temperature 150°C Storage Temperature Range.....-65°C to 150°C Peak Package Solder Reflow Temperature (40 seconds maximum exposure)..... 260°C Lead Temperature. (Soldering 10 seconds)..... 300°C	 <p style="text-align: center;">LX27901ID D PACKAGE (Top View) RoHS / Pb-free Matte Tin Pin Finish</p>
Notes: Exceeding these ratings could cause damage to the device. All voltages are with respect to GND. Currents are positive into, negative out of specified terminal. These are stress ratings only and functional operation of the device at these or any other conditions beyond those indicated under "Recommended Operating Conditions" are not implied. Exposure to "Absolute Maximum Ratings" for extended periods may affect device reliability.	

ELECTRICAL CHARACTERISTICS						
Unless otherwise listed, the following specifications apply over the operating ambient temperature of $-40^{\circ}\text{C} < \text{Temp} < 85^{\circ}\text{C}$, and $V_{IN} = 7.5\text{V to } 27\text{V}$, except where otherwise noted and the following test conditions: $V_{IN} = 12\text{V}$, $C_{C,R} = 330\text{pF}$, $R_{C,R} = 15\text{K}$						
Parameters	Symbol	Test Conditions/Comments	MIN	TYP	MAX	Units
Power						
Controller Input Voltage	VIN		7.5		27	V
Controller Operating Voltage	VDD	1 μF bypass cap on VDD pin, $I_{VDD} = 0$ to 5mA	5.0	5.25	5.5	V
Power Supply Input Current	IIN	AOUT, BOUT = no load, VDD = no load		7	10	mA
Sleep Mode Current	IDD _{SLEEP}	VIN = 24V, $V_{ENABLE} < 0.8\text{V}$		200	400	μA
VDD Off Voltage		ENABLE < 0.8V		0.1		V
Enable						
ENABLE On	EN _H		1.7			V



ELECTRICAL CHARACTERISTICS

Unless otherwise listed, the following specifications apply over the operating ambient temperature of $-40^{\circ}\text{C} < \text{Temp} < 85^{\circ}\text{C}$, and $V_{\text{IN}} = 7.5\text{V}$ to 27V , except where otherwise noted and the following test conditions: $V_{\text{IN}} = 12\text{V}$, $C_{\text{C}_R} = 330\text{pF}$, $R_{\text{C}_R} = 15\text{K}$

Parameters	Symbol	Test Conditions/Comments	MIN	TYP	MAX	Units
Shut Down	EN _L				0.8	V
LLC Resonant Mode Threshold	V _{LLCTH}	LLC resonant drive mode, VDD = 5.25V	2		3	V
PWM Switching Mode Threshold	V _{PWMTH}	PWM switching drive mode, VDD = 5.25V	3		4	V
Synchronous LED Drive Mode Threshold	V _{SYN}	Synchronous LED drive mode, VDD = 5.25V	4		VDD	V
Input High Current	EN _{I_{IH}}	ENABLE = 2V			10	μA
Input Low Current	EN _{I_{IL}}	0V < V _{ENABLE} < 0.8V			5	μA
Under Voltage Lockout						
VDD Startup Threshold	VDD _{UVLOR}	Rising Threshold.	4.35	4.6	4.8	V
VDD UVLO Threshold	VDD _{UVLOF}	Falling Threshold.	4.0	4.2	4.45	V
VDD UVLO Hysteresis	VDD _{UVLOH}			0.4		V
Output						
Output Resistance	R _{SINK}	I _{SINK} , AOUT and BOUT, T _A = 25°C		5	6	Ω
Output Resistance	R _{SOURCE}	I _{SOURCE} , AOUT and BOUT, T _A = 25°C		5	6	Ω
Dead Time	OUT _{DT}	T _A = 25°C, at full duty	250	330	410	ns
C_OUT Output Resistance	R _{C_OUT}	Source and sink		15	20	Ω
Switching Frequency Oscillator						
Switching Frequency Tolerance	OSCIN _{PWM}	T _A = 25°C, Frequency of AOUT, BOUT in PWM mode, C _{C_R} =330pF, R _{C_R} = 15K.	128.8	140	151.2	kHz
Max Oscillator Frequency	OSC _{MAX_LL}	T _A = 25°C, Frequency of AOUT, BOUT in LLC mode, C _{C_R} =330pF, R _{C_R} = 15K.		1		MHz
LLC Frequency Control Current Source		V _{ENABLE} < 2.8V	0		200	μA
Ramp Valley Voltage	OSCVV			0.5		V
Ramp Peak Voltage	OSCPV			2.5		V
Synchronization Range		Ratio of UVS/SYN input over C_R oscillator free run frequency	1.05		3	Ratio
LED Dimming Control						
ISNS Reference	ISNS _{REF}	T _A = 25°C, input, Corresponds to 2V after 4.75X internal amplifier.	414.6	421	426.4	mV
ISNS Linear Input Range		Linear operation range for internal circuit	800			mV
BRTA Input Range		4.75 times of ISNS signal. Input outside the range is clamped at upper or lower limit internally.	0.5		2.0	V
Pre-Amplifier Gain	K _{PRAMP}			4.75		
Error Amp Output Capacity		Source and Sink		100		μA

ELECTRICAL CHARACTERISTICS

Unless otherwise listed, the following specifications apply over the operating ambient temperature of $-40^{\circ}\text{C} < \text{Temp} < 85^{\circ}\text{C}$, and $V_{\text{IN}} = 7.5\text{V}$ to 27V , except where otherwise noted and the following test conditions: $V_{\text{IN}} = 12\text{V}$, $C_{\text{C,R}} = 330\text{pF}$, $R_{\text{C,R}} = 15\text{K}$

Parameters	Symbol	Test Conditions/Comments	MIN	TYP	MAX	Units
DIM Input Voltage Range	V_{DIM}	Effective for duty from 0 to 100%	0.5		2.0	V
PWM Dimming Mode Control Threshold	V_{PDMODETH}	Voltage level of FAULT pin, in ACU_BRITE PWM dimming mode when below threshold; in conventional PWM dimming mode when above threshold.	2.8	3.0	3.2	V

Fault Monitoring and Protection

VSNS Threshold	$VSNS_{\text{TH}}$	Fault when above the threshold	1.8	2.0	2.2	V
VSNS Clamping Current Source	I_{CLAMP}	Pull down source at COMP pin		160		μA
UVS/SYN Threshold	UVS/SYN_{TH}	Fault when below the threshold, positive and negative input	0.35	0.4	0.45	V
UVS/SYN Input Range	$V_{\text{UVS/SYN}}$	Functional operation range, positive and negative input	-0.5		4	V
ISNS Fault Threshold	V_{ISNSTH}	Fault when below the threshold	85	100	115	mV
Over Current Threshold	OC_{TH}	Upper threshold for ISNS input	550	600	650	mV
Short Circuit Threshold	SC_{TH}	Upper threshold for ISNS input	870	930	990	mV
Fault Count	FC	At clock frequency of AOUT, BOUT		256		Count
Fault reset Interval	F_{RESET}	Interval for resetting fault counter, At clock frequency of AOUT, BOUT		32768		Count
Fault Output Sinking Capacity	F_{SINK}	$V_{\text{FAULT}} \leq 0.8\text{V}$, $T_{\text{A}} = 25^{\circ}\text{C}$	4	6		mA
Fault Output Open Impedance	R_{F}	When in open state	5			$\text{M}\Omega$

Bias & References

Internal Master Reference Voltage	V_{REF}			1.2		V
Soft Start Charging Source	I_{SSC}	C_B Charging source at start up		2		μA

Power-Up Sequencing

Power On Reset Time	TPOR	After UVLO of VDD released	50			μs
Start up Time Out	TSTART	After POR		32768		Count

FUNCTIONAL PIN DESCRIPTION

Name	Pin #	Description
VIN	1	Input voltage pin. A built-in regulator is connected to this pin to step down the input voltage to the internal operating voltage VDD. This pin can accept input voltage from 10V to 27V to provide the flexibility of interfacing with either 12V or 24V system supply. A low ESR decoupling capacitor of not less than $1\mu\text{F}$ should be connected from this pin to GND with low impedance traces.
ENABLE	2	Enable pin to control the on/off operation of the controller. A logic low signal $<0.8\text{V}$ on this pin sets the



FUNCTIONAL PIN DESCRIPTION

Name	Pin #	Description
		controller in sleep mode to save energy, and a signal > 2V activates the controller operation. The DC signal level on this pin also sets the drive mode of the controller. When $2V < V_{ENABLE} < 3V$ the AOUT, BOUT signals are set in LLC resonant drive mode. When $3V < V_{ENABLE} < 4V$ the controller drives the power converter in normal PWM drive mode; and when $V_{ENABLE} > 4V$ the controller is set in synchronous LED drive mode.
C_R	3	Converter operating frequency programming terminal. A pull-up resistor from this pin to VDD and a capacitor connected from this pin to ground determines the switching frequency of the inverter.
BRTA	4	Terminal for programming the analog LED current setting. An analog signal is accepted from this pin to set the reference level for the LED current control loop.
DIM	5	PWM dimming control input. $V_{DIM} > 2V$ sets the dimming operation in continuous analog mode. A PWM signal of low level <0.5V and high level > 2V will force the PWM dimming operation to follow the PWM signal directly. Input level <0.5V will stop the controller output.
SST/BCOM	6	For PWM dimming brightness compensation and soft start. The elapsed dimming demand and the accumulated LED current over the active dimming period are compared at this pin. The comparison result is used to control the LED light output to exactly match the dimming demand with compensation for the distortion of the LED current during dimming operation. At start up this pin is connected to a 2μA charging current source to control the soft start process. An internal active pull down circuit is connected from this pin to COMP to force the COMP voltage rise slowly with the charge of the capacitor at this pin. Soft start completes when the voltage rises to 2.5V and the control enters normal operation mode. The 2μA charging source and the COMP pull down circuit is disconnected then, and this pin is connected to the brightness compensation circuit.
FAULT	7	Fault indication pin with open drain output. Internally pulled down when an open LED string, severely shorted LED string, over voltage of the LED strings, or over current occurs. Once latched, the fault signal can only be reset by ENABLE or power recycling. The voltage level at this pin during normal operation also sets the operation mode of dimming control. When the voltage is above 3V the COMP signal is turned on and off by the digital dimming control signal and AOUT, BOUT and C_OUT are turned on and off accordingly by the COMP signal. When the voltage at the FAULT pin is below 3V the COMP signal is turned on and off by the control signal from the ACU_BRITE dimming control algorithm, and AOUT, BOUT and C_OUT are turned on and off accordingly by the COMP signal. The voltage level of this pin during normal operation can be set by an external resistive divider.
UVS/SYN	8	Sense for under voltage conditions. A threshold of 0.4V is set internally to compare the sense feedback signal to this pin when the LED strings are on. A fault will be declared if the sensed signal stays below the threshold over certain counts set by the internal circuitry. LED string current and voltage sense signals can be fed to this pin to detect open or short string conditions. When the controller is set in synchronous regulation mode UVS/SYN will receive the synchronization signal from the power supply to synchronize the switching frequency of AOUT and BOUT. An internal rectifier circuit is included to allow an AC input signal to be connected to this pin directly.
VSNS	9	Voltage sense input pin. The voltage signal on this pin feeds the over voltage detection circuit. A threshold of 2V is set internally for fault detection. When the voltage sense signal reaches the threshold of 2V, a clamping current source will be activated to pull down COMP signal to limit the sensed voltage. In the meanwhile, the fault monitoring circuit will start counting the accumulated fault duration and set up the fault flag when the fault count reaches pre-determined counts.
ISNS	10	Current sense input pin. A full wave rectifier circuit is built in to allow AC input to this pin. The regulation point at this pin is 421mV which is amplified by 4.75 times and then fed to the error amplifier to compare with a reference signal of 2V to regulate the LED current. This signal is also used to detect open LED, over current and short circuit conditions. The threshold for open LED is 100mV, the threshold of over current is 600mV, and the threshold for short circuit is 930mV. A fault flag will be declared if ISNS signal stays below 100mV or above 600mV over defined counts, and the operation will be cut off immediately when ISNS signal goes above 930mV.



FUNCTIONAL PIN DESCRIPTION

Name	Pin #	Description
COMP	11	Output of the error amplifier. The error amplifier is a GM type that provides robust control behavior and simple compensation. The signal on this pin feeds to the PWM modulation circuit to control the drive output to regulate the LED current. At start up the voltage of this pin is controlled by the soft start circuit.
C_OUT	12	Gate signal to drive an additional MOSFET for LED current regulation. The signal is synchronized with the C_R oscillator frequency and is leading edge modulated by the output of the error amplifier in LLC and synchronous regulation modes and trailing edge modulated in PWM half-bridge drive mode. This signal can be used in combination with AOUT and BOUT to extend the regulation range in LLC operation mode or provide additional driving capabilities in synchronous regulation mode.
AOUT BOUT	15 13	Gate drive outputs. These driver outputs are capable of providing 0.8A source and sink current at nominal operating voltage. Dead time is inserted to prevent possible shoot through at full duty cycle. Internal pull down resistors of 20kΩ are provided at each of these pins. When the controller is in LLC mode AOUT and BOUT are driven to maximum duty cycle (50%), and their switching frequency varies with the COMP signal level. When the controller is in PWM mode these two outputs generate standard (non-resonant) synchronous pulse-width modulated signals at fixed frequency. When the controller is in synchronous LED drive mode, UVS/SYN receives the synchronization signal, AOUT outputs an N-channel FET drive signal synchronized with the rising edge of the (UVS/SYN) sync input signal, and BOUT outputs a P-channel FET drive signal synchronized with the falling edge cycle of the (UVS/SYN) sync input signal. Together they drive the external power devices to control the LED current directly (synchronous topology). This is different from the PWM mode, because the pulse-width of AOUT and BOUT signals is <i>leading edge modulated</i> in the synchronous drive mode.
GND	14	Ground return of the on chip circuit. It is important to provide a low impedance ground plane to this pin and the signal control circuitry in PCB layout, and not let the ground return current of the inverter power circuit flow through the signal ground plane. Low ESR bypass capacitors for VDD and VDD should be connected with lowest possible impedance to this pin through the signal ground plane.
VDD	16	The operating voltage of the IC. A built-in regulator supplies a regulated 5.25V derived from VIN supply to this pin. A low ESR decoupling capacitor of not less than 1μF should be connected from this pin to GND with low impedance traces.



FUNCTIONAL BLOCK DIAGRAM

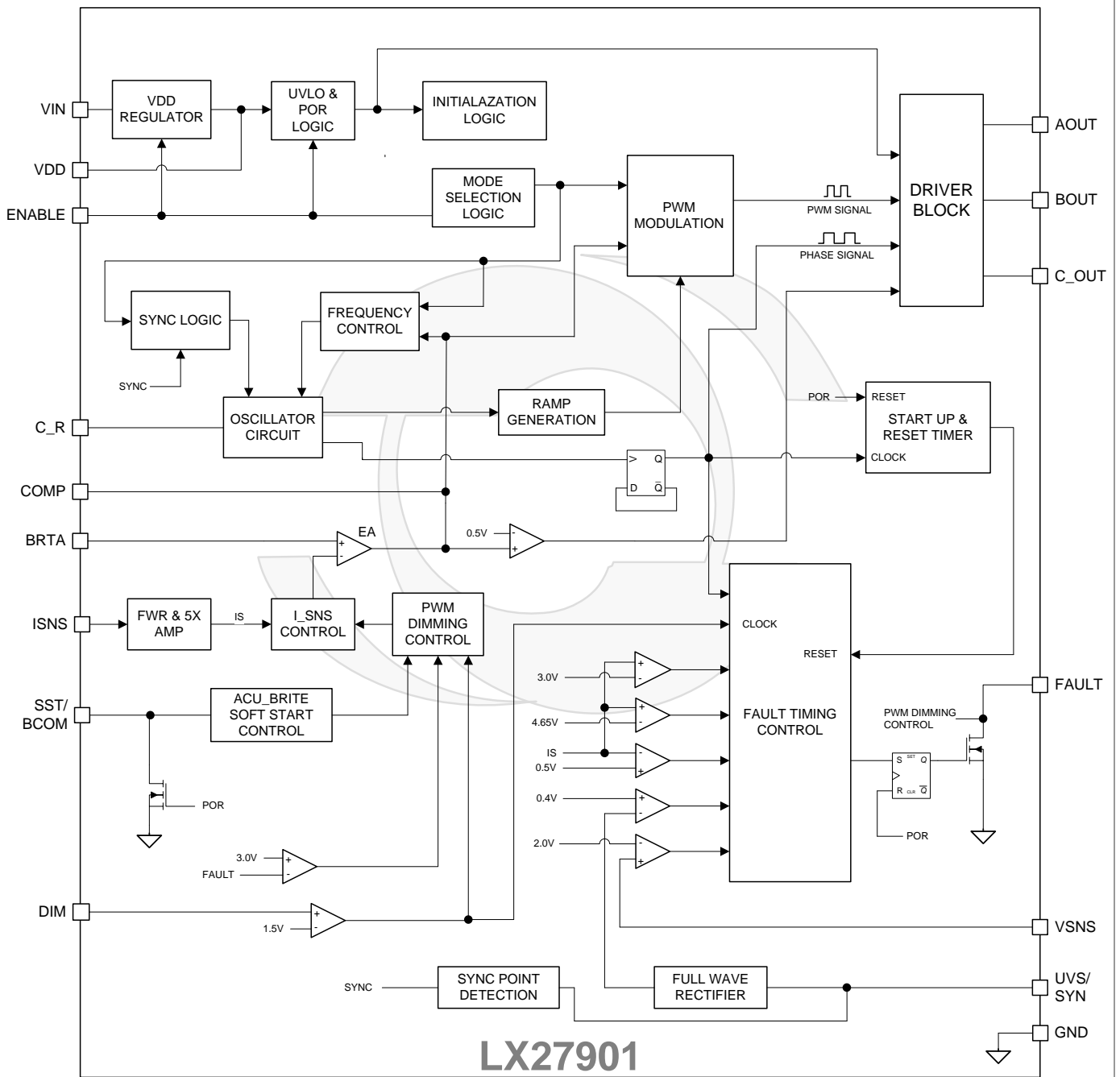


Figure 1. LX27901 Functional Block Diagram.



TYPICAL PERFORMANCE CHARACTERISTICS

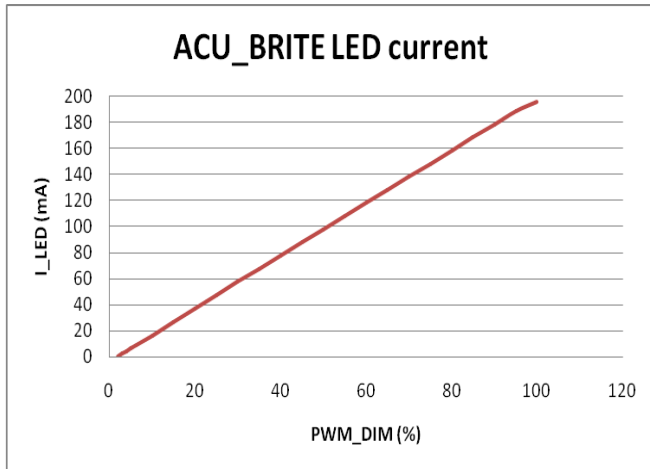


Figure 2

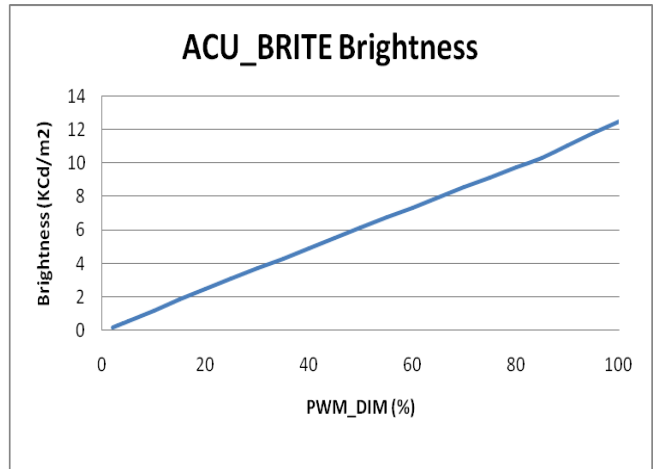


Figure 3

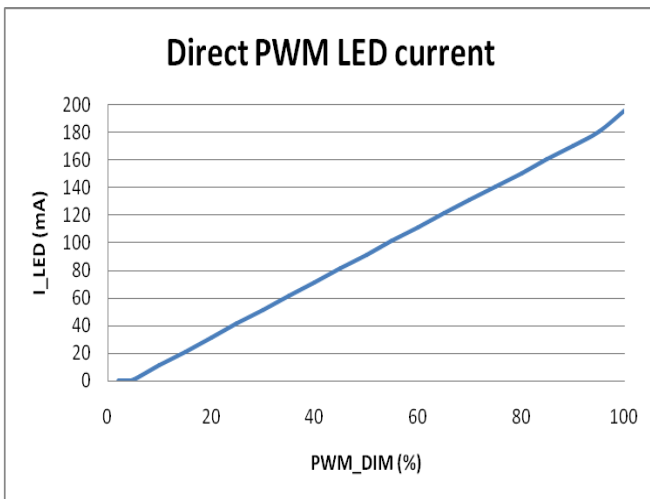


Figure 4

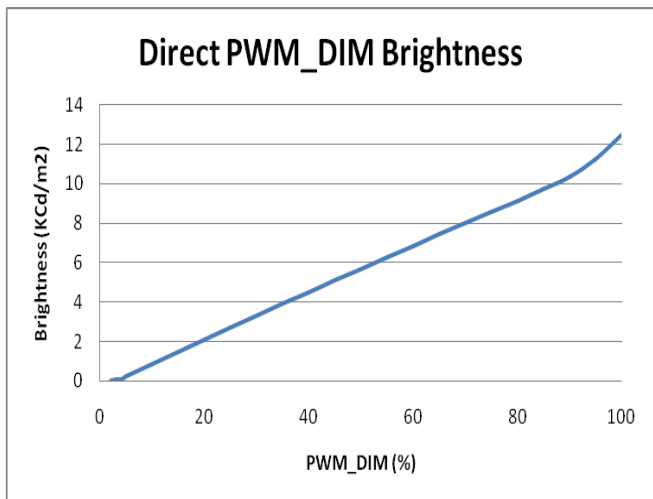


Figure 5

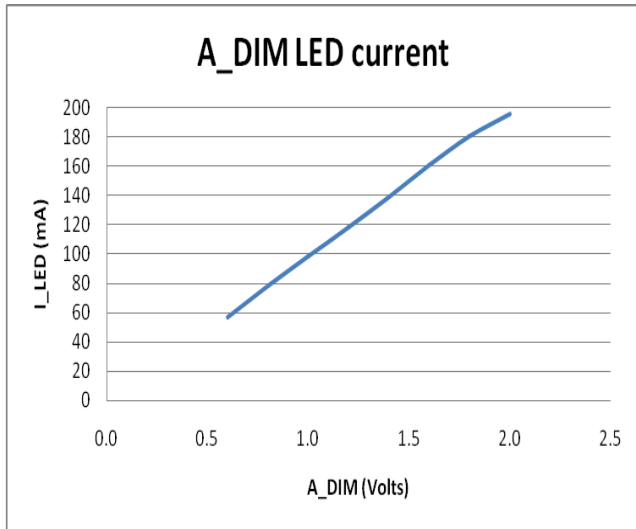
PRELIMINARY DATASHEET


Figure 6

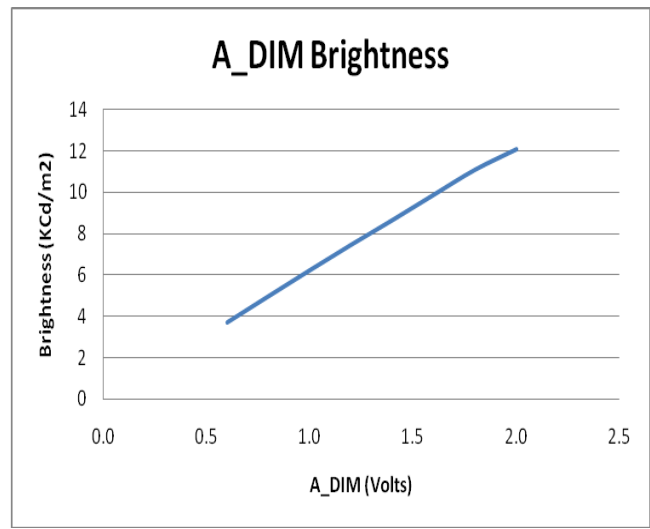
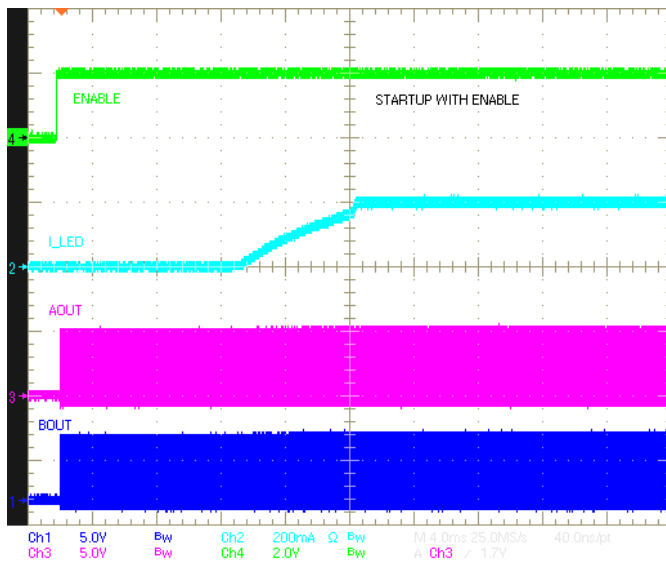
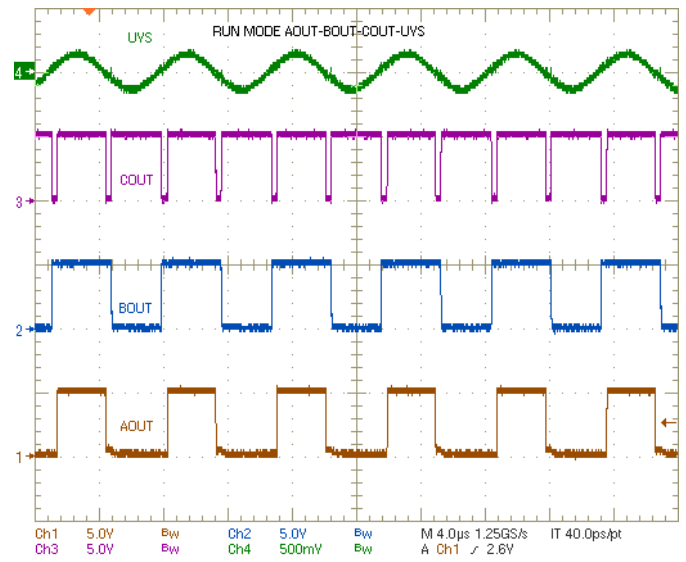


Figure 7

TYPICAL PERFORMANCE CHARACTERISTICS
STARTUP WITH ENABLE LLC MODE

 Figure 8
 Channel 1: BOUT, Channel 2: I_LED
 Channel 3: ADUT, Channel 4: ENABLE

OUTPUT TIMING SYNC MODE

 Figure 9
 Channel 1: ADUT, Channel 2: BOUT
 Channel 3: COUT, Channel 4: UVS

DIMMING SYNC MODE
VSNS OV PROTECTION MODE



PRELIMINARY DATASHEET

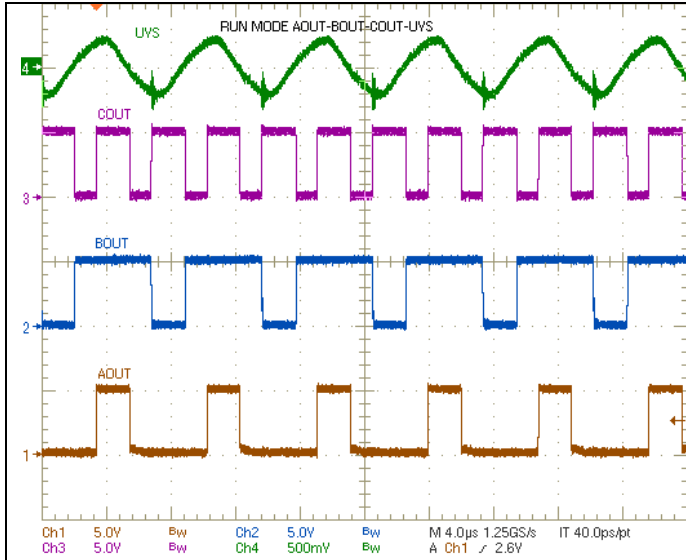


Figure 10
Channel 1: AOUT, Channel 2: BOUT
Channel 3: COUT, Channel 4: UVS

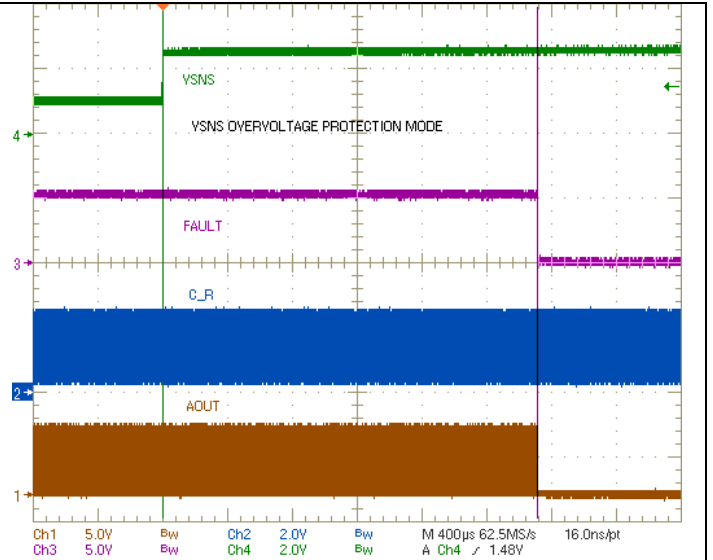


Figure 11
Channel 1: AOUT, Channel 2: C_R
Channel 3: FAULT, Channel 4: VSNS



TYPICAL PERFORMANCE CHARACTERISTICS

LLC DIMMING MODE

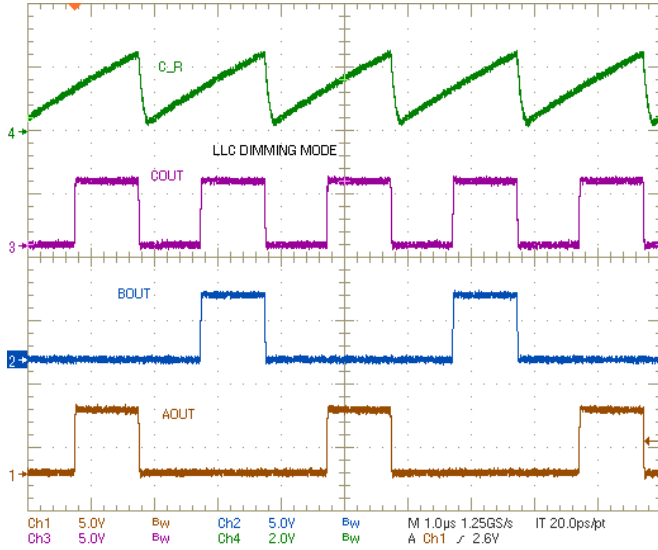


Figure 12
Channel 1: AOUT, Channel 2: BOUT
Channel 3: COUT, Channel 4: C_R

PWM DIMMING MODE

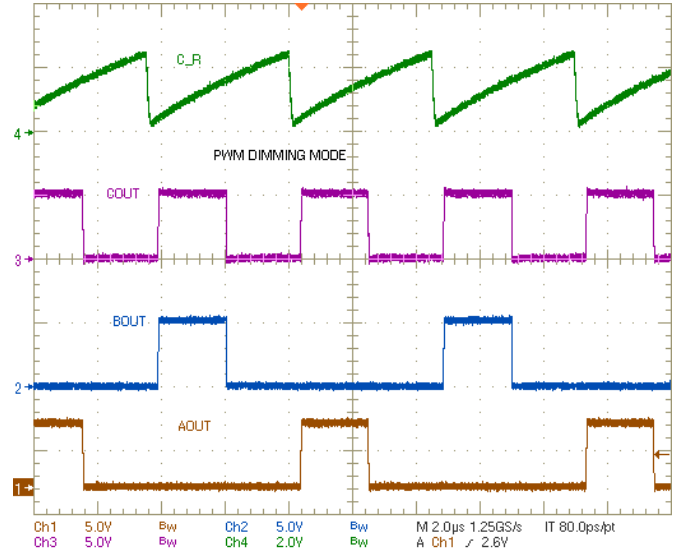


Figure 13
Channel 1: AOUT, Channel 2: BOUT
Channel 3: COUT, Channel 4: C_R

ACU_BRITE DIMMING MODE

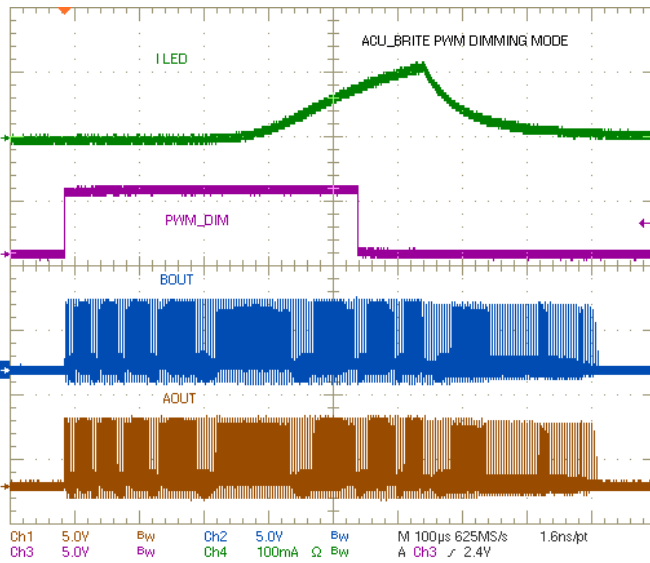


Figure 14
Channel 1: AOUT, Channel 2: BOUT
Channel 3: PWM_DIM, Channel 4: I_LED

DIRECT PWM DIMMING MODE

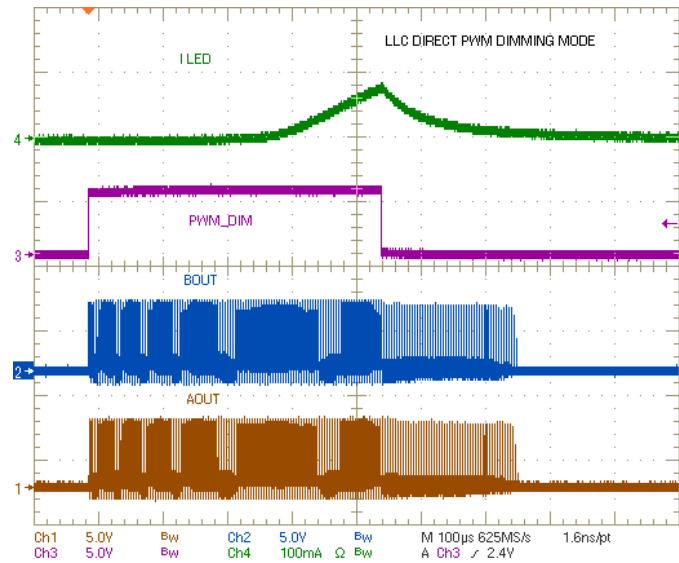


Figure 15
Channel 1: AOUT, Channel 2: BOUT
Channel 3: PWM_DIM, Channel 4: I_LED



TYPICAL PERFORMANCE CHARACTERISTICS

ACU_BRITE DIMMING MODE

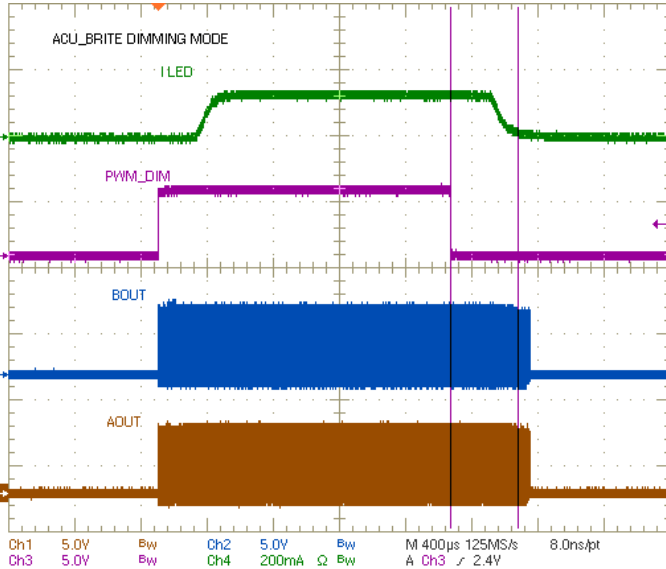


Figure 16

Channel 1: AOUT, Channel 2: BOUT
Channel 3: PWM_DIM, Channel 4: ILED

DIRECT PWM DIMMING MODE

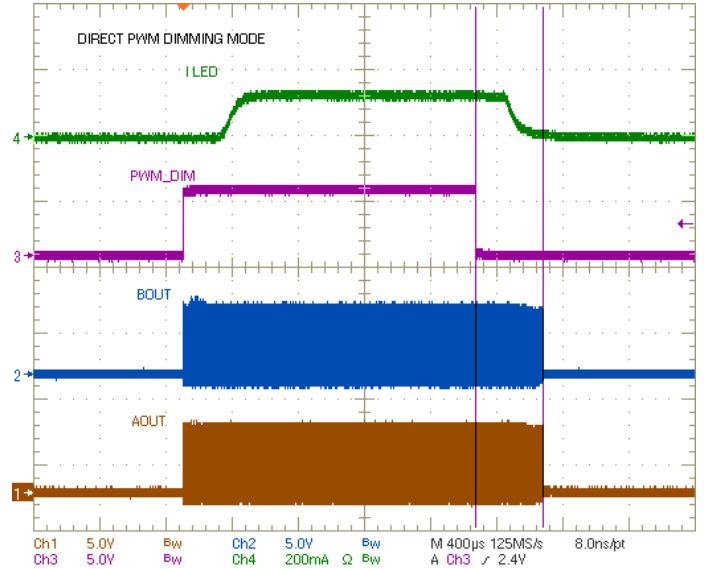


Figure 17

Channel 1: AOUT, Channel 2: BOUT
Channel 3: PWM_DIM, Channel 4: ILED



TYPICAL APPLICATION SCHEMATIC

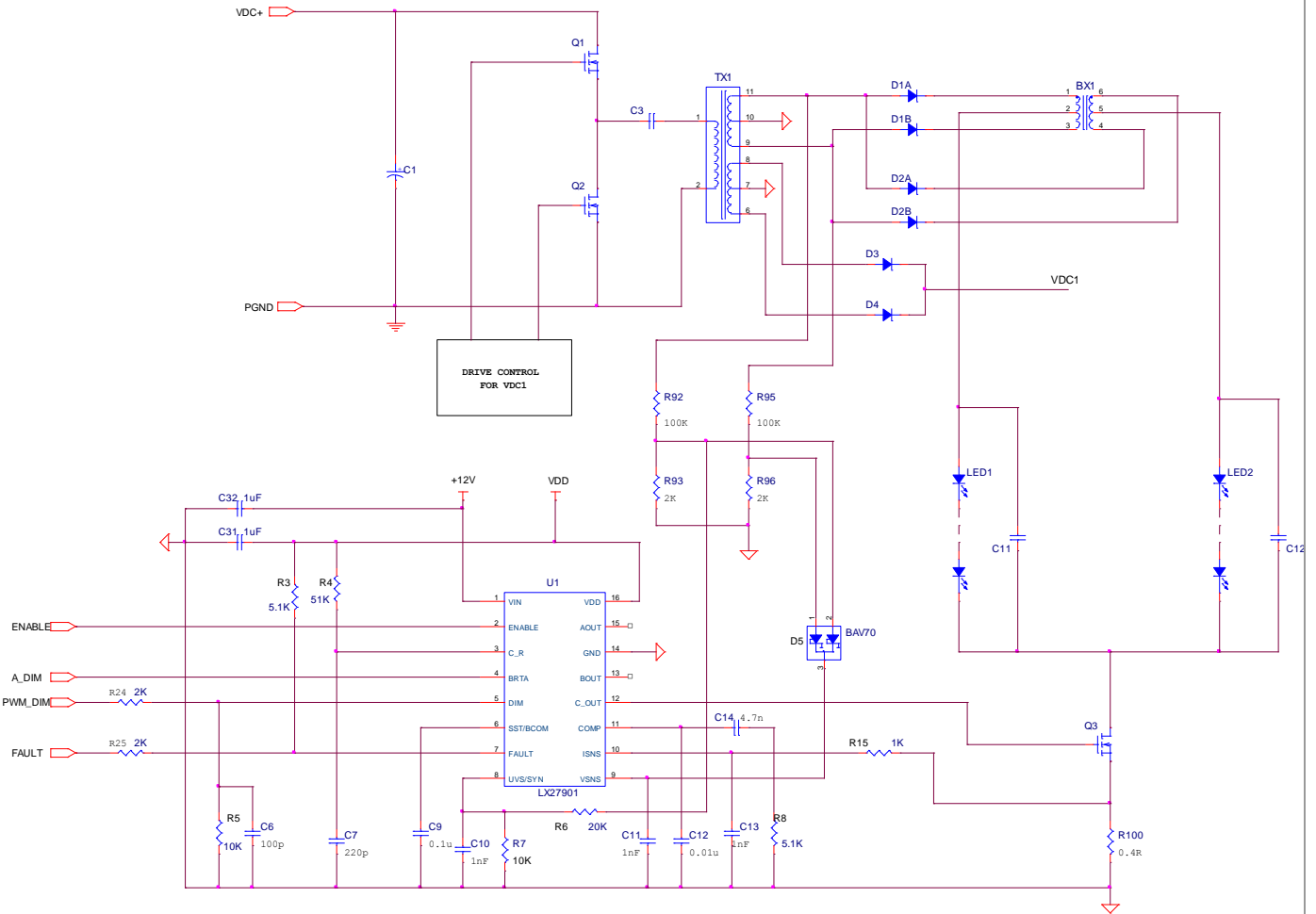


Figure 19
SYNCHRONOUS REGULATION MODE

(The component values are for reference only, modifications may be necessary for a particular application requirement.)



OPERATION DESCRIPTION

INTRODUCTION

This section describes the operation of LX27901 LED drive controller. LX27901 is primarily designed for LIPS power systems for LED backlit LCD TV and other large screen CCFL backlight applications that addresses the need to drive a half bridge or full bridge inverter stage from the 400V PFC output across the safety isolation barrier. It provides an optimized low cost solution for such applications while providing a set of comprehensive control features to fully satisfy the technical requirements.

1. SYSTEM OVERVIEW

The system contains the following main function blocks:

- Power and Start-Up Logic*
- Oscillator and Frequency Control Circuit*
- Regulation Control Circuit*
- Dimming Control Circuit*
- Drive Control Circuitry*
- Fault Detection and Protection Circuitry*

The power and start-up logic provides regulated power to the on chip circuitry and controls the start-up sequencing, power on reset, and soft start operation etc. The oscillator and frequency logic generates the clock signals for the LLC and PWM operation and timing for the operation and protection. The regulation and dimming control logic handles the LED current regulation and dimming control operation with Microsemi's proprietary ACU_BRITE technology to provide accurate brightness control with non-dissipative operation of the power devices. The drive control circuit converts the PWM signal from the regulation and control circuit to power drive signals to drive the external power devices of the power supply and LED string control. The fault detection and protection logic monitors the operation of the internal and external circuits and provides fault warning and protection for the system.

2. POWER CONTROL AND START UP

The LX27901 has a built in regulator to step down the input voltage VIN to a regulated 5.25V supply VDD to support the on chip circuitry. The regulator is controlled by the ENABLE signal and is only activated when ENABLE voltage goes above its logic threshold, thus

minimizing the power consumption at sleep mode. An UVLO circuit is employed to monitor the VDD voltage. The UVLO circuit releases the lock out function when VDD reaches its rising threshold and initiates the Power On Reset (POR) signal.

The POR signal initializes the whole control circuitry by resetting the counters, registers, fault latch, setting the analog signals such as the SST/BCOM and C_B voltage to pre-determined initial values, while holding off the output signals to pre-determined inactive states. After the preset delay time the POR signal is released and the controller operation starts.

3. OSCILLATOR AND FREQUENCY CONTROL

The system has a built in clock to control the switching frequency. A resistor and a capacitor are required, connected between VDD and C_R pin and from C_R pin to ground respectively to set the oscillating frequency. A controlled charging current source is also provided internally to the C_R pin to adjust the oscillator frequency when the ENABLE voltage level is set in LLC resonance control mode. When the ENABLE voltage level is set in PWM mode, the current source is disconnected and the oscillator returns to the free run frequency set by the external RC components.

4. REGULATION CONTROL

The regulation circuit controls the LED current through closed loop regulation. The LED current is sensed and fed to the ISNS pin as a feedback signal where it is regulated by an internal transconductance error amplifier to match the current reference threshold. This controls the PWM drive of the external switching MOSFETs of the power conversion circuit. The output of the error amplifier, available on the COMP pin, allows the user to adjust the control loop directly if desired. Three power supply control modes are incorporated into the controller operation

LLC Resonant control Mode: In LLC resonant mode the PWM drive output signals AOUT and BOUT remain at full duty cycle (50%), and the output signal from the error amplifier controls the internal charging current source at C_R pin to adjust the switching frequency of AOUT and BOUT to regulate the LED current. Note that in this mode the operating frequency of the drive signals should be always higher than the resonance frequency.



OPERATION DESCRIPTION

PWM control Mode: The internal current source at C_R pin is disconnected and AOUT and BOUT signals remain at the fixed frequency set by the RC components at C_R pin, and the LED current is regulated by adjusting the pulse width of the AOUT and BOUT signals.

Synchronous regulation Mode: The synchronization signal from the power supply is received from UVS/SYN pin and AOUT and BOUT output drive signals in synchronous with the synchronization signal to drive respective external switches in series with the LED strings to control the LED current. In this mode AOUT and BOUT are leading edge modulated PWM drive signals controlled by the closed current loop from ISNS feedback. The three control modes are selectable by the voltage level of ENABLE signal. When $2V < V_{ENABLE} < 3V$ the controller is in LLC resonant drive mode; when $3V < V_{ENABLE} < 4V$ the controller drives the power supply in PWM drive mode; and when $V_{ENABLE} > 4V$ the controller drives the external device in synchronous regulation mode.

5. DIMMING CONTROL

The LX27901 supports external burst dimming and analog dimming functions. In external digital dimming mode a dimming pulse train is supplied to DIM pin and the dimming operation follows the input pulse train directly. It is recommended that the high state of the pulse train should be higher than 2V and the low state should be lower than 0.5V. This signal is compared with an internal DC level of 1.5V to generate an internal PWM pulse train to control the burst dimming operation.

A unique feature called ACU_BRITE is incorporated to compensate the LED current error by digital dimming duty adjustment. A capacitor from SST/BCOM pin to ground provides an integration function for such control. A controlled charging current source and a controlled discharging current source are connected internally to the SST/BCOM pin. The charging current source is linearly proportional to the internal current regulation reference and turned on and off by the internal digital dimming signal. The discharging current source is proportional to the ISNS signal at the same ratio as the charging source to the internal reference. At power on reset the SST/BCOM capacitor is discharged to zero and the capacitor is used for soft start operation. When the capacitor voltage reaches 2.5V it switches over to ACU_BRITE dimming control function. The voltage of

SST/BCOM is fed to a comparator and compared with a threshold level of 2.5V. When $V_{SST/BCOM}$ is greater than 2.5V, the LED current is turned on, and when $V_{SST/BCOM}$ is lower than 2.5V, the LED current is turned off.

With such control mechanism the integration of the LED current always matches the integration of its reference over the digital dimming operation to yield an accurate brightness control. This feature essentially enables the control of dimming operation by turning on and off the power supply directly without losing dimming accuracy, instead of putting an additional control device in series with the LED string to control the LED on/off. The LED current distortion at the rising and falling edge of the digital dimming operation is accurately compensated by the dimming duty adjustment, the no load power supply losses at LED off state are eliminated, and the serial control device is removed.

6. DRIVE CONTROL CIRCUIT

The drive control circuit converts the PWM signal from the regulation and control circuit to the drive output signals AOUT, BOUT and C_OUT to drive the external power devices for the power supply and LED string control. The signals from AOUT and BOUT are 180° out of phase. When the controller is in LLC resonant mode AOUT and BOUT remain at full duty, and their switching frequency varies with the COMP signal level to adjust the power supply output. When the controller is in the PWM control mode AOUT and BOUT remain at a fixed switching frequency but their duty cycle varies with the COMP signal level. When in synchronous regulation mode AOUT outputs a NFET drive signal in synchronous with the positive cycle of the synchronization signal from UVS/SYN pin, and BOUT outputs a PFET drive signal in synchronous with the negative cycle of the synchronization signal from UVS/SYN to drive the external devices. In this mode the AOUT and BOUT signal is a leading edge modulated PWM signal with their falling edge in synchronous with the zero crossing point of the synchronization signal to minimize their turn off transient and their pulse width is controlled by the closed current loop from ISNS feedback. The driving capacity of AOUT and BOUT is 0.8A in both the sourcing and sinking mode.

The signal from C_OUT provides the user additional control for LED current regulation. The signal is in synchronous with the C_R oscillator frequency and is



OPERATION DESCRIPTION

leading edge modulated by the output of the error amplifier in LLC and synchronous regulation modes, and trailing edge modulated in PWM half bridge drive mode. This signal can be used in combination with AOUT and BOUT to extend regulation range in LLC operation mode or provide additional driving capabilities in synchronous regulation mode.

7. SOFT START

Soft start is accomplished by internal circuitry in combination with the SST/BCOM capacitor charging control. At power on the SST/BCOM capacitor is discharged to zero during POR. When the operation commences following POR the SST/BCOM pin is disconnected from the dimming control circuit and a small soft start current source of 2 μ A is turned on to charge the SST/BCOM capacitor slowly. The voltage of the SST/BCOM capacitor pulls down the COMP signal through the soft start circuit to force the V_{COMP} signal to rise slowly together with it. During this course the voltage amplitude of SST/BCOM is monitored. When the SST/BCOM signal rises to 2.5V, the soft start current source is turned off and the SST/BCOM pin switches over to the internal dimming control circuit. The capacitor at SST/BCOM is charged and discharged by the ACU_BRITE brightness compensation circuit and its voltage is compared with a 2.5V reference to turn on and off the AOUT, BOUT and C_OUT signals while the COMP signal resumes its role in the regulation function. During start up a timer-counter circuit is also furnished to monitor the system operation. If the ISNS signal does not reach 100mV after the counter reaches the full count of 32k (15 bit) clock cycles, the start-up is considered failed and a fault flag is raised by pulling down the FAULT pin signal.

8. FAULT DETECTION AND PROTECTION

The following system operating conditions are monitored with fault reporting and protection: Open LED string, Short LED string, Power supply failure, Over voltage and Over current. The above fault conditions are monitored from the ISNS, VSNS and UVS/SYN inputs. The ISNS signal is used to monitor open LED, power supply failure and over current conditions. Open LED detection is disabled during start up until the 15 bit counter times out.

After the counter time out if ISNS signal is still below 100mV while the LED is on, it indicates an open LED or power supply failure condition. A fault counter will start to count the fault. When the counter reaches the full count of 256, a fault condition is confirmed and the FAULT pin is pulled to low state to indicate a fault condition. The fault counter is incremented by a clock at the same frequency as AOUT, BOUT and reset periodically at an interval of 32768 clock pulses. In addition, during the interval if there is any single occurrence of $ISNS > 100mV$ it will reset the fault counter and the fault counting has to start all over again. Such reset mechanism guarantees reliable fault detection and prevents noise triggered false fault reporting. The ISNS signal is also used to monitor over current and short circuit conditions. A typical threshold of 600mV is set for over current detection and a typical threshold of 930mV is set for short circuit detection. The fault counter will start counting when $ISNS > 600mV$ occurs and reports a fault when the counter reaches full count of 256. Periodical reset at every 32768 clock cycle interval is also employed for the fault counter.

In addition, a time delay circuit, similar to a one shot, is employed to hold the over current status for about 50 μ s. The fault counter will be reset if the over current condition does not persist when the elapsed holding time is over. When ISNS signal exceeds 930mV typically it will be recognized as a short circuit. The output signal will be shut off immediately with a fault flag raised. The short circuit detection is active all the time after POR release.

The VSNS signal is used to limit and monitor over voltage condition. When the voltage sense signal reaches the threshold of 2V, a clamping current source will be activated to pull down COMP signal to limit the sensed voltage. In the meanwhile, the fault counter starts counting and reports fault condition when the counter reaches full count. Periodical reset at every 32768 clock cycle interval also applies to the VSNS fault counting. Similarly a time delay circuit is also employed to hold the over voltage status for about 50 μ s. The fault counter will be reset if the over voltage condition does not persist when the elapsed holding time is over. In actual applications, if a balancer network is deployed in the drive system, the signals from the secondary winding loop can also be fed to VSNS pin to detect open or short LED fault. When a LED string is open or shorted, the



OPERATION DESCRIPTION

voltage in the primary and secondary winding of the associated balancer will rise dramatically, and such distinctive signal change can be readily used for open or short LED detection with VSNS circuit.

The UVS/SYN signal provides further means for fault detection. A threshold of 0.4V is set internally for the UVS/SYN signal. When UVS/SYN < 0.4V occurs, the fault counter also starts counting and reports a fault condition when the counter reaches full count. Periodical reset at every 32k clock cycle interval also applies to the UVS/SYN fault count. Similarly a time delay circuit is also employed to hold the over voltage status for about 50µs. The fault counter will be reset if the over current condition does not persist when the elapsed holding time is over.

SETTING OPERATING FREQUENCY

The switching frequency of AOUT and BOUT is programmed with the external capacitor and resistor, R_{C_R} and C_{C_R} .

$$f_{SW} \approx \frac{693000}{R_{C_R} \cdot C_{C_R}}$$

f_{SW} is the switching frequency in kHz, R_{C_R} is in kohms, and C_{C_R} is in pF. For most applications, lamp free run frequency is set at less than 150kHz. Normally C_{C_R} can be chosen from 220pF to 470pF, and the value of R_{C_R} can also be used to adjust the frequency control range in LLC mode.

SETTING COMP PIN CAPACITOR

An external capacitor C_{COMP} is connected from this pin to ground to adjust loop response of the inverter module. The error amplifier is a GM type that provides robust control behavior and simple compensation. The ideal current error amplifier compensation depends on the dimming mode operation range. If minimal dimming is required by the application the loop response can be slower, but for wide range digital dimming it must be fast enough to allow the lamp current to get to full amplitude within a few current cycles.

If value of C_{COMP} is small the gain will be increased and

may result in overshoot, and the loop could become unstable. However as the capacitor value is increased it will reduce the gain and the loop response may be too slow. Therefore it is necessary to choose an optimal value, typical recommended values range from 1nF to 10nF, but should be adjusted depending on the application requirements.

VIN, VDD BYPASS CAPACITOR

The LX27901 has internal Low Dropout Regulator to generate an accurate 5V supply for the internal control circuitry. In order to have stable operation, it is required to provide bypass capacitor with low ESR between both VIN and VDD and ground. It is recommended to use a capacitance of not less than 1µF for VIN and 1µF for VDD.

LAYOUT GUIDELINES

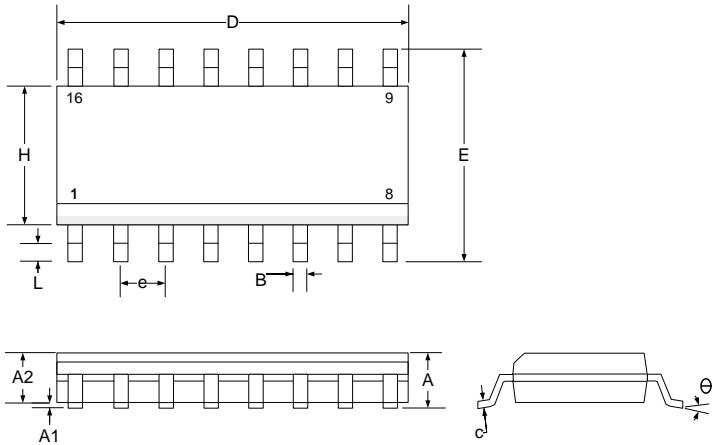
It is important to have a good PCB layout to achieve stable operation. Especially, high voltage section and the power switching section of the circuit layout require particular attention. High voltage section layout also needs to be planned carefully to meet Safety requirement as well as proper isolation from the control circuit. Following are guidelines for inverter PCB layout

- 1) Use a star-ground connection for analog and power ground. Analog ground should be isolated from power ground except one connection point, GND pin.
- 2) Route high speed digital signal traces away from sensitive analog signals.
- 3) Place decoupling cap as close to related pin as possible.
- 4) Make shortest and direct connection from feedback sources.
- 5) Keep short and wide for high current signal paths especially ground.
- 6) Make trace as thick as possible
- 7) Route current sense and voltage divider traces away from high voltage field.



PACKAGE DIMENSIONS

D 16-Pin Plastic Narrow Body SOIC



DIM	MILLIMETERS		INCHES	
	MIN	MAX	MIN	MAX
A	1.35	1.75	0.053	0.069
A1	0.10	0.25	0.004	0.010
A2	1.25	1.52	0.049	0.060
b	0.33	0.51	0.013	0.020
c	0.19	0.25	0.007	0.010
D	9.78	10.01	0.385	0.394
E	5.79	6.20	0.228	0.244
e	1.27 BSC		0.050 BSC	
H	3.81	4.01	0.150	0.158
L	0.40	1.27	0.016	0.050
Θ	0	8	0	8
*LC		0.10		0.004

*Lead Coplanarity

Note:

- Controlled dimensions are in mm, inches are for reference only.
- Dimensions do not include mold flash or protrusions; these shall not exceed 0.155mm (.006") on any side. Lead dimension shall not include solder coverage.



Microsemi[®]

LX27901

Multipurpose High Performance LED Controller

PRELIMINARY DATASHEET

NOTES

PRELIMINARY DATA – Information contained in this document is pre-production data and is proprietary to Microsemi. It may not be modified in any way without the express written consent of Microsemi. Product referred to herein is offered in pre-production form only and may not have completed Microsemi’s Quality Assurance process for Release to Production. Microsemi reserves the right to change or discontinue this proposed product at any time.



Стандарт Электрон Связь

Мы молодая и активно развивающаяся компания в области поставок электронных компонентов. Мы поставляем электронные компоненты отечественного и импортного производства напрямую от производителей и с крупнейших складов мира.

Благодаря сотрудничеству с мировыми поставщиками мы осуществляем комплексные и плановые поставки широчайшего спектра электронных компонентов.

Собственная эффективная логистика и склад в обеспечивает надежную поставку продукции в точно указанные сроки по всей России.

Мы осуществляем техническую поддержку нашим клиентам и предпродажную проверку качества продукции. На все поставляемые продукты мы предоставляем гарантию .

Осуществляем поставки продукции под контролем ВП МО РФ на предприятия военно-промышленного комплекса России , а также работаем в рамках 275 ФЗ с открытием отдельных счетов в уполномоченном банке. Система менеджмента качества компании соответствует требованиям ГОСТ ISO 9001.

Минимальные сроки поставки, гибкие цены, неограниченный ассортимент и индивидуальный подход к клиентам являются основой для выстраивания долгосрочного и эффективного сотрудничества с предприятиями радиоэлектронной промышленности, предприятиями ВПК и научно-исследовательскими институтами России.

С нами вы становитесь еще успешнее!

Наши контакты:

Телефон: +7 812 627 14 35

Электронная почта: sales@st-electron.ru

Адрес: 198099, Санкт-Петербург,
Промышленная ул, дом № 19, литера Н,
помещение 100-Н Офис 331