

NPN - MPS8099; PNP - MPS8599

Preferred Device

Amplifier Transistors

Voltage and Current are Negative for PNP Transistors

Features

- Pb-Free Packages are Available*

MAXIMUM RATINGS

Rating	Symbol	Value	Unit
Collector - Emitter Voltage	V_{CEO}	80	Vdc
Collector - Base Voltage	V_{CBO}	80	Vdc
Emitter - Base Voltage	V_{EBO}	5.0	Vdc
Collector Current - Continuous	I_C	500	mAdc
Total Device Dissipation @ $T_A = 25^\circ\text{C}$ Derate above 25°C	P_D	625 5.0	mW mW/ $^\circ\text{C}$
Total Device Dissipation @ $T_C = 25^\circ\text{C}$ Derate above 25°C	P_D	1.5 12	W mW/ $^\circ\text{C}$
Operating and Storage Junction Temperature Range	T_J, T_{stg}	-55 to +150	$^\circ\text{C}$

THERMAL CHARACTERISTICS

Characteristic	Symbol	Max	Unit
Thermal Resistance, Junction-to-Ambient (Note 1)	$R_{\theta JA}$	200	$^\circ\text{C}/\text{W}$
Thermal Resistance, Junction-to-Case	$R_{\theta JC}$	83.3	$^\circ\text{C}/\text{W}$

Stresses exceeding Maximum Ratings may damage the device. Maximum Ratings are stress ratings only. Functional operation above the Recommended Operating Conditions is not implied. Extended exposure to stresses above the Recommended Operating Conditions may affect device reliability.

- $R_{\theta JA}$ is measured with the device soldered into a typical printed circuit board.

*For additional information on our Pb-Free strategy and soldering details, please download the ON Semiconductor Soldering and Mounting Techniques Reference Manual, SOLDERRM/D.



ON Semiconductor®

<http://onsemi.com>

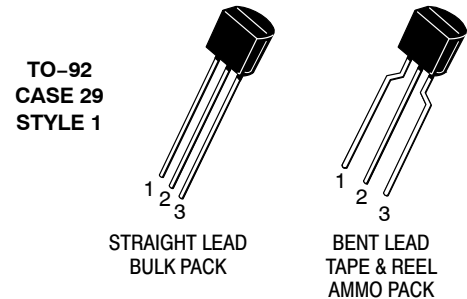
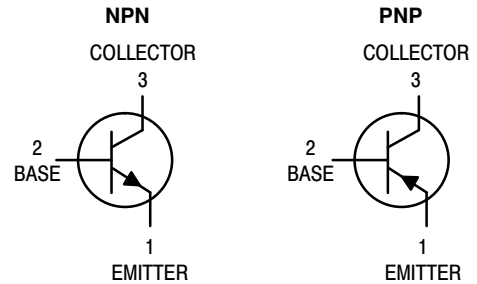

MARKING DIAGRAM

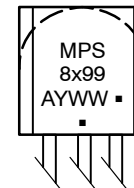

- x = 0 or 5
- A = Assembly Location
- Y = Year
- WW = Work Week
- = Pb-Free Package

(Note: Microdot may be in either location)

ORDERING INFORMATION

See detailed ordering and shipping information in the package dimensions section on page 3 of this data sheet.

Preferred devices are recommended choices for future use and best overall value.

NPN – MPS8099; PNP – MPS8599

ELECTRICAL CHARACTERISTICS (T_A = 25°C unless otherwise noted)

Characteristic	Symbol	Min	Max	Unit
OFF CHARACTERISTICS				
Collector – Emitter Breakdown Voltage (Note 2) (I _C = 10 mA _{dc} , I _B = 0)	V _{(BR)CEO}	80	–	V _{dc}
Collector – Base Breakdown Voltage (I _C = 100 μA _{dc} , I _E = 0)	V _{(BR)CBO}	80	–	V _{dc}
Emitter – Base Breakdown Voltage (I _E = 10 μA _{dc} , I _C = 0)	V _{(BR)EBO}	5.0	–	V _{dc}
Collector Cutoff Current (V _{CE} = 60 V _{dc} , I _B = 0)	I _{CES}	–	0.1	μA _{dc}
Collector Cutoff Current (V _{CB} = 80 V _{dc} , I _E = 0)	I _{CBO}	–	0.1	μA _{dc}
Emitter Cutoff Current (V _{EB} = 4.0 V _{dc} , I _C = 0)	I _{EBO}	–	0.1	μA _{dc}
ON CHARACTERISTICS (Note 2)				
DC Current Gain (I _C = 1.0 mA _{dc} , V _{CE} = 5.0 V _{dc}) (I _C = 10 mA _{dc} , V _{CE} = 5.0 V _{dc}) (I _C = 100 mA _{dc} , V _{CE} = 5.0 V _{dc})	h _{FE}	100 100 75	300 – –	–
Collector – Emitter Saturation Voltage (I _C = 100 mA _{dc} , I _B = 5.0 mA _{dc}) (I _C = 100 mA _{dc} , I _B = 10 mA _{dc})	V _{CE(sat)}	– –	0.4 0.3	V _{dc}
Base–Emitter On Voltage (I _C = 10 mA _{dc} , V _{CE} = 5.0 V _{dc})	V _{BE(on)}	0.6	0.8	V _{dc}
SMALL–SIGNAL CHARACTERISTICS				
Current – Gain – Bandwidth Product (I _C = 10 mA _{dc} , V _{CE} = 5.0 V _{dc} , f = 100 MHz)	f _T	150	–	MHz
Output Capacitance (V _{CB} = 5.0 V _{dc} , I _E = 0, f = 1.0 MHz)	C _{obo}	–	8.0	pF
Input Capacitance (V _{EB} = 0.5 V _{dc} , I _C = 0, f = 1.0 MHz)	C _{ibo}	–	30	pF

2. Pulse Test: Pulse Width ≤ 300 μs, Duty Cycle = 2.0%.

NPN – MPS8099; PNP – MPS8599

ORDERING INFORMATION

Device	Package	Shipping†
MPS8099G	TO-92 (Pb-Free)	5000 Units / Bulk
MPS8099RLRAG	TO-92 (Pb-Free)	2000 / Tape & Reel
MPS8099RLRP	TO-92	2000 / Ammo Pack
MPS8099RLRPG	TO-92 (Pb-Free)	2000 / Ammo Pack
MPS8599RLRAG	TO-92 (Pb-Free)	2000 / Tape & Reel
MPS8599RLRMG	TO-92 (Pb-Free)	2000 / Ammo Pack

†For information on tape and reel specifications, including part orientation and tape sizes, please refer to our Tape and Reel Packaging Specification Brochure, BRD8011/D.

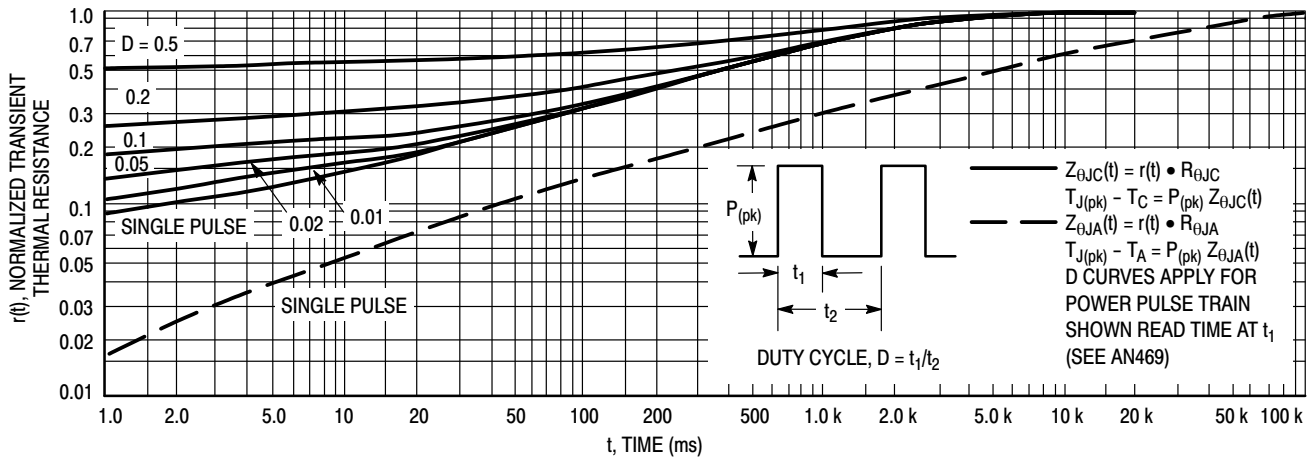
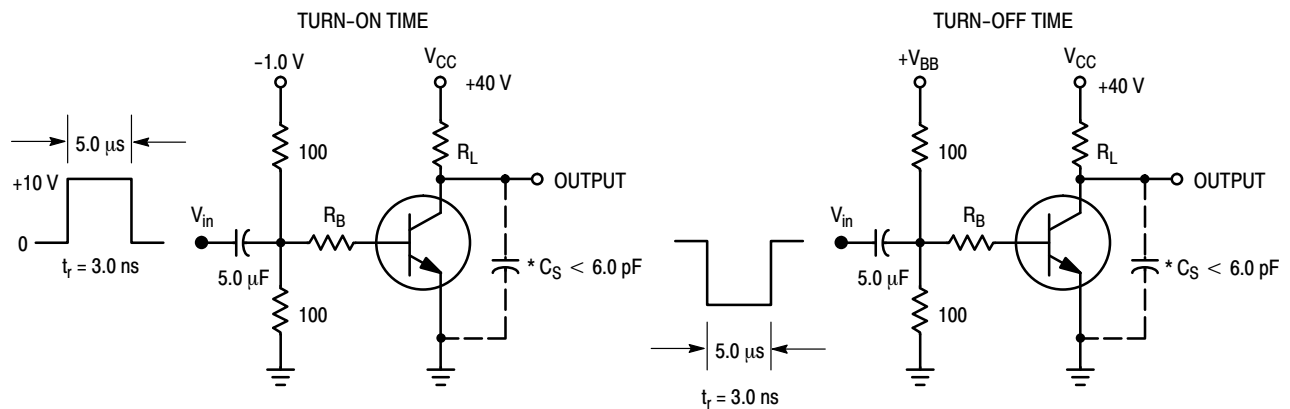

Figure 1. Thermal Response



*Total Shunt Capacitance of Test Jig and Connectors For PNP Test Circuits, Reverse All Voltage Polarities

Figure 2. Switching Time Test Circuits

NPN – MPS8099; PNP – MPS8599

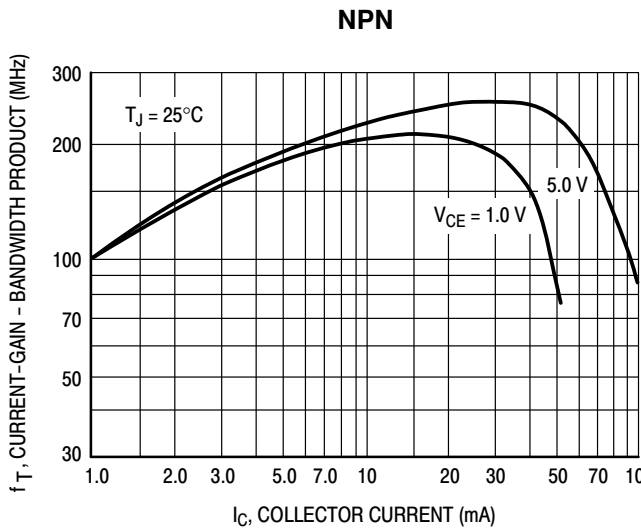

Figure 3. Current-Gain – Bandwidth Product

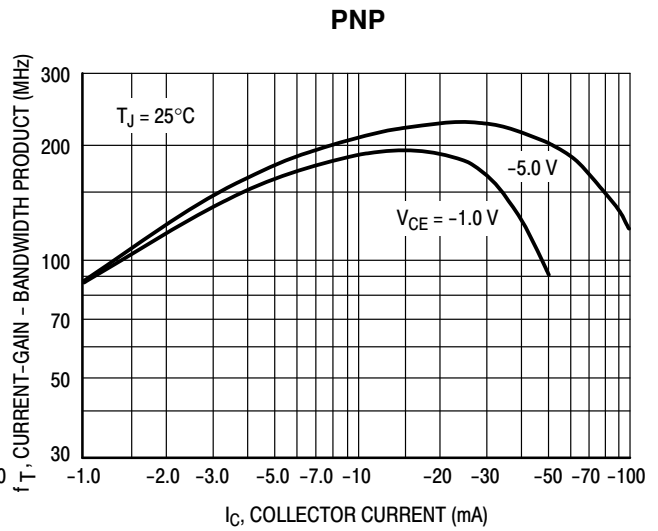

Figure 4. Current-Gain – Bandwidth Product

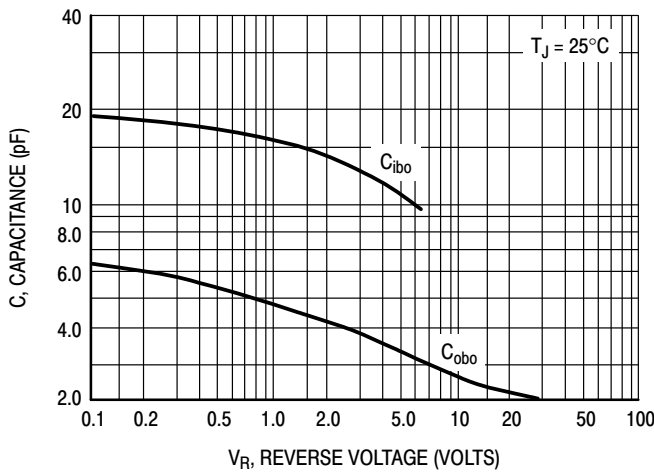

Figure 5. Capacitance

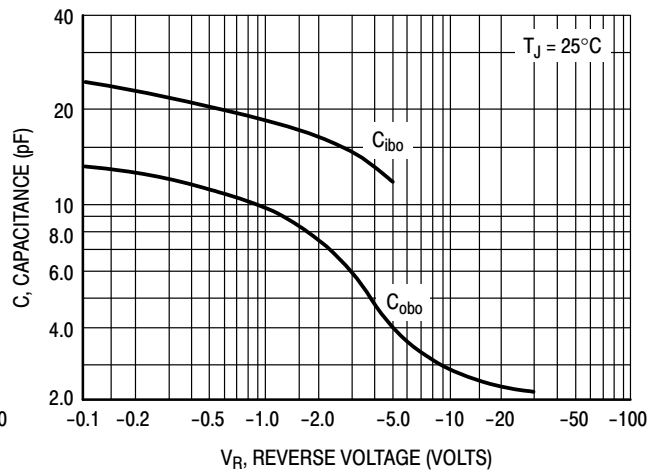

Figure 6. Capacitance

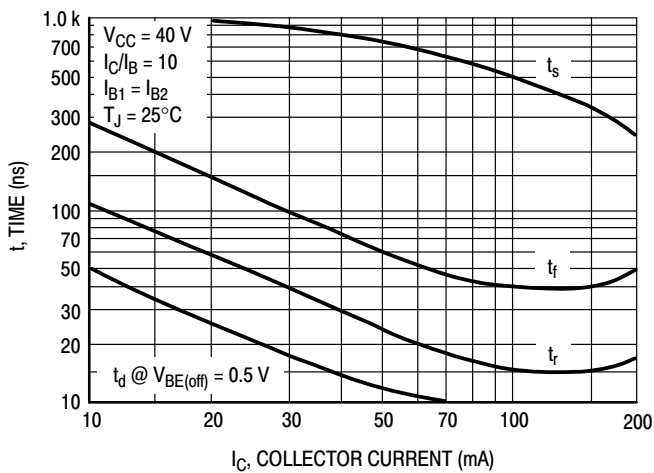

Figure 7. Switching Times

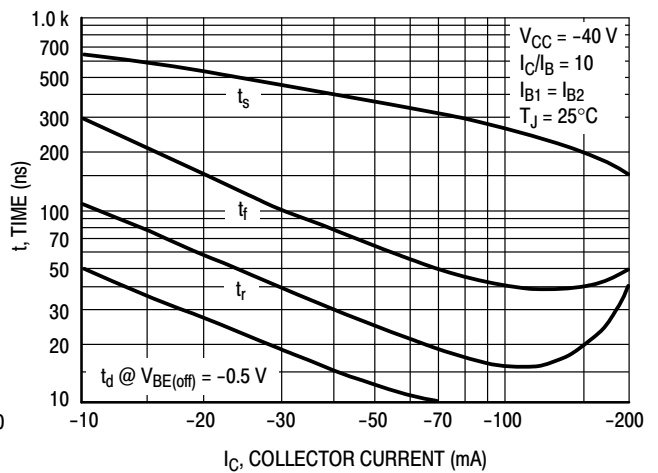

Figure 8. Switching Times

NPN – MPS8099; PNP – MPS8599

NPN

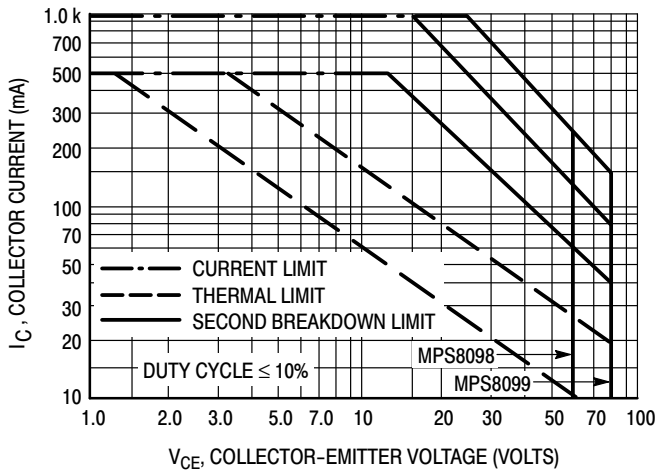

Figure 9. Active-Region Safe Operating Area

PNP

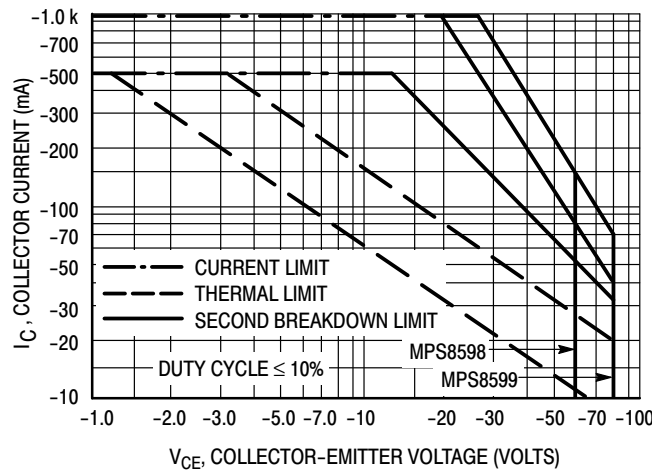

Figure 10. Active-Region Safe Operating Area

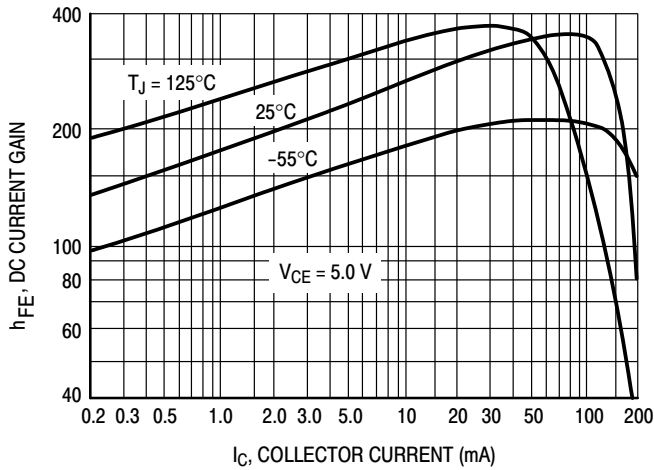

Figure 11. DC Current Gain

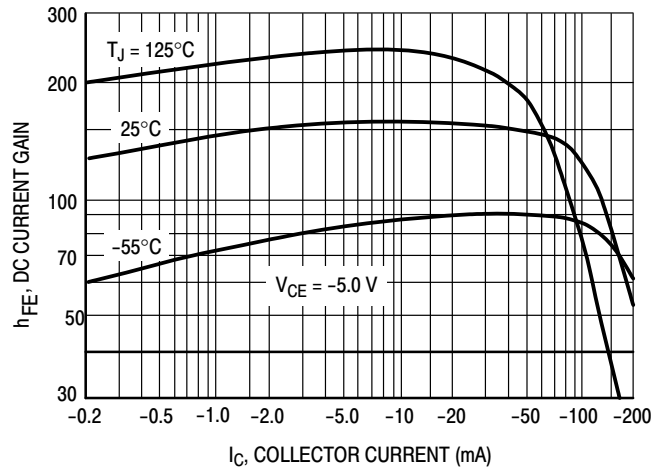

Figure 12. DC Current Gain

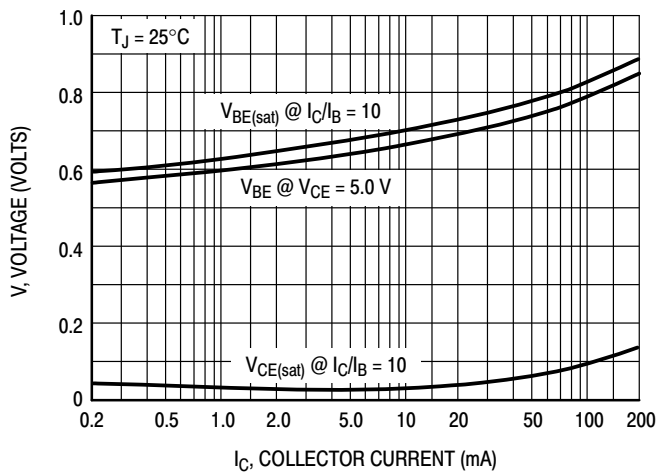

Figure 13. "ON" Voltages

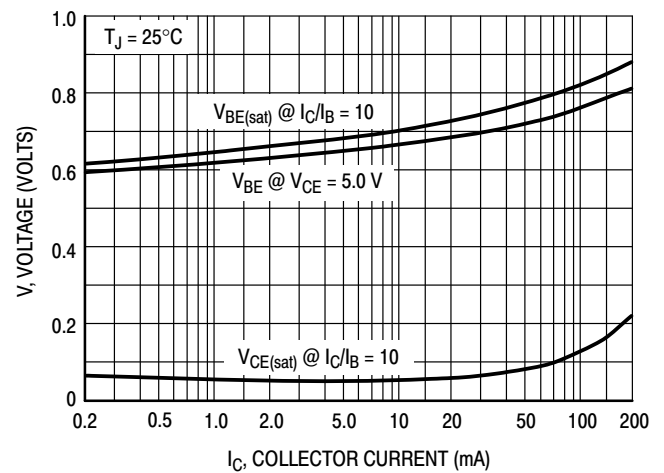

Figure 14. "ON" Voltages

NPN – MPS8099; PNP – MPS8599

NPN

PNP

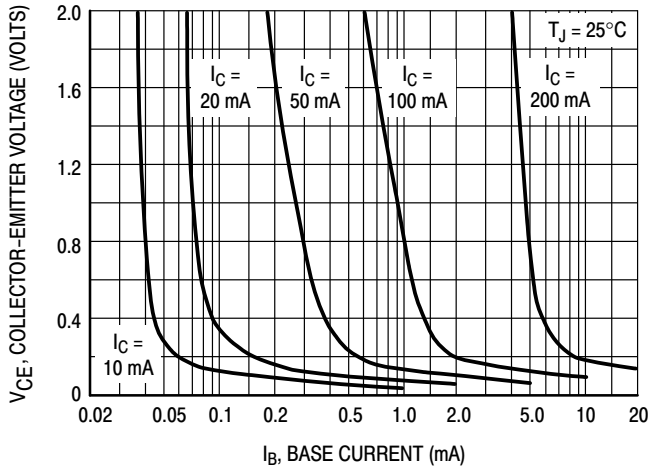

Figure 15. Collector Saturation Region

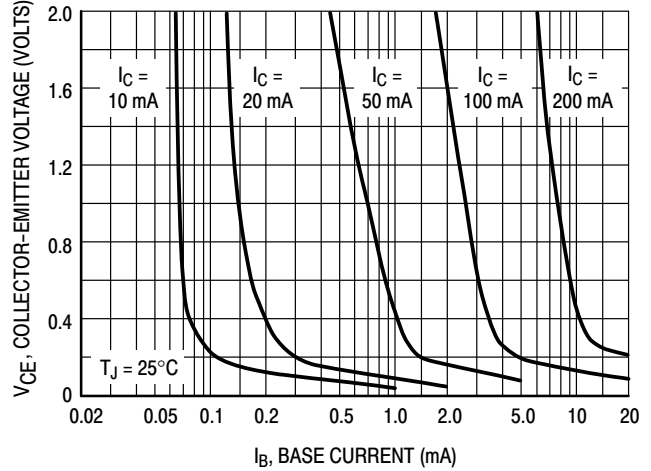

Figure 16. Collector Saturation Region

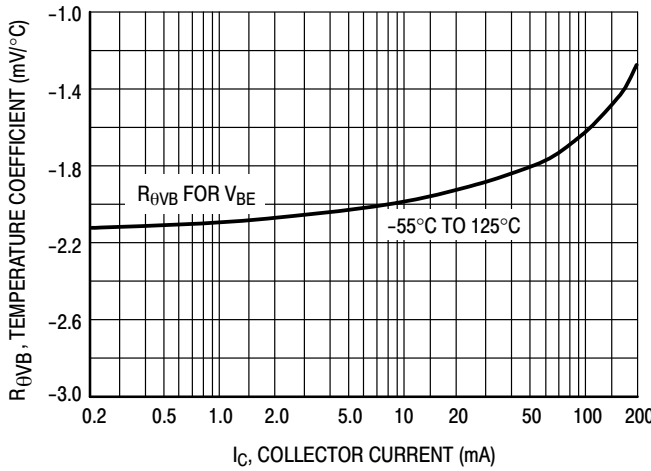

Figure 17. Base-Emitter Temperature Coefficient

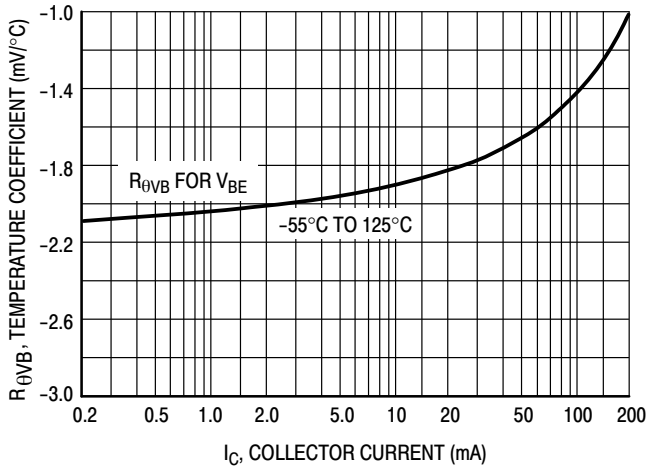
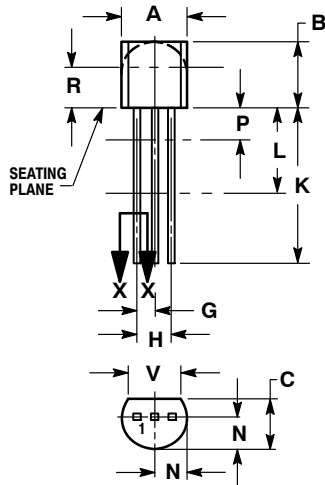

Figure 18. Base-Emitter Temperature Coefficient

NPN – MPS8099; PNP – MPS8599

PACKAGE DIMENSIONS

TO-92 (TO-226)
CASE 29-11
ISSUE AM



STRAIGHT LEAD
BULK PACK

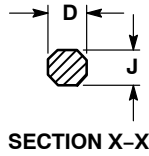

SECTION X-X

NOTES:

1. DIMENSIONING AND TOLERANCING PER ANSI Y14.5M, 1982.
2. CONTROLLING DIMENSION: INCH.
3. CONTOUR OF PACKAGE BEYOND DIMENSION R IS UNCONTROLLED.
4. LEAD DIMENSION IS UNCONTROLLED IN P AND BEYOND DIMENSION K MINIMUM.

DIM	INCHES		MILLIMETERS	
	MIN	MAX	MIN	MAX
A	0.175	0.205	4.45	5.20
B	0.170	0.210	4.32	5.33
C	0.125	0.165	3.18	4.19
D	0.016	0.021	0.407	0.533
G	0.045	0.055	1.15	1.39
H	0.095	0.105	2.42	2.66
J	0.015	0.020	0.39	0.50
K	0.500	---	12.70	---
L	0.250	---	6.35	---
N	0.080	0.105	2.04	2.66
P	---	0.100	---	2.54
R	0.115	---	2.93	---
V	0.135	---	3.43	---

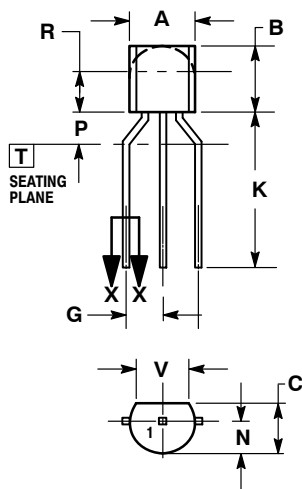

BENT LEAD
TAPE & REEL
AMMO PACK

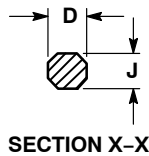

SECTION X-X

NOTES:

1. DIMENSIONING AND TOLERANCING PER ASME Y14.5M, 1994.
2. CONTROLLING DIMENSION: MILLIMETERS.
3. CONTOUR OF PACKAGE BEYOND DIMENSION R IS UNCONTROLLED.
4. LEAD DIMENSION IS UNCONTROLLED IN P AND BEYOND DIMENSION K MINIMUM.

DIM	MILLIMETERS	
	MIN	MAX
A	4.45	5.20
B	4.32	5.33
C	3.18	4.19
D	0.40	0.54
G	2.40	2.80
J	0.39	0.50
K	12.70	---
N	2.04	2.66
P	1.50	4.00
R	2.93	---
V	3.43	---

STYLE 1:

1. EMITTER
2. BASE
3. COLLECTOR

ON Semiconductor and are registered trademarks of Semiconductor Components Industries, LLC (SCILLC). SCILLC reserves the right to make changes without further notice to any products herein. SCILLC makes no warranty, representation or guarantee regarding the suitability of its products for any particular purpose, nor does SCILLC assume any liability arising out of the application or use of any product or circuit, and specifically disclaims any and all liability, including without limitation special, consequential or incidental damages. "Typical" parameters which may be provided in SCILLC data sheets and/or specifications can and do vary in different applications and actual performance may vary over time. All operating parameters, including "Typicals" must be validated for each customer application by customer's technical experts. SCILLC does not convey any license under its patent rights nor the rights of others. SCILLC products are not designed, intended, or authorized for use as components in systems intended for surgical implant into the body, or other applications intended to support or sustain life, or for any other application in which the failure of the SCILLC product could create a situation where personal injury or death may occur. Should Buyer purchase or use SCILLC products for any such unintended or unauthorized application, Buyer shall indemnify and hold SCILLC and its officers, employees, subsidiaries, affiliates, and distributors harmless against all claims, costs, damages, and expenses, and reasonable attorney fees arising out of, directly or indirectly, any claim of personal injury or death associated with such unintended or unauthorized use, even if such claim alleges that SCILLC was negligent regarding the design or manufacture of the part. SCILLC is an Equal Opportunity/Affirmative Action Employer. This literature is subject to all applicable copyright laws and is not for resale in any manner.

PUBLICATION ORDERING INFORMATION

LITERATURE FULFILLMENT:
Literature Distribution Center for ON Semiconductor
P.O. Box 5163, Denver, Colorado 80217 USA
Phone: 303-675-2175 or 800-344-3860 Toll Free USA/Canada
Fax: 303-675-2176 or 800-344-3867 Toll Free USA/Canada
Email: orderlit@onsemi.com

N. American Technical Support: 800-282-9855 Toll Free
USA/Canada
Europe, Middle East and Africa Technical Support:
Phone: 421 33 790 2910
Japan Customer Focus Center
Phone: 81-3-5773-3850

ON Semiconductor Website: www.onsemi.com
Order Literature: <http://www.onsemi.com/orderlit>
For additional information, please contact your local
Sales Representative



Стандарт Электрон Связь

Мы молодая и активно развивающаяся компания в области поставок электронных компонентов. Мы поставляем электронные компоненты отечественного и импортного производства напрямую от производителей и с крупнейших складов мира.

Благодаря сотрудничеству с мировыми поставщиками мы осуществляем комплексные и плановые поставки широчайшего спектра электронных компонентов.

Собственная эффективная логистика и склад в обеспечивает надежную поставку продукции в точно указанные сроки по всей России.

Мы осуществляем техническую поддержку нашим клиентам и предпродажную проверку качества продукции. На все поставляемые продукты мы предоставляем гарантию .

Осуществляем поставки продукции под контролем ВП МО РФ на предприятия военно-промышленного комплекса России , а также работаем в рамках 275 ФЗ с открытием отдельных счетов в уполномоченном банке. Система менеджмента качества компании соответствует требованиям ГОСТ ISO 9001.

Минимальные сроки поставки, гибкие цены, неограниченный ассортимент и индивидуальный подход к клиентам являются основой для выстраивания долгосрочного и эффективного сотрудничества с предприятиями радиоэлектронной промышленности, предприятиями ВПК и научно-исследовательскими институтами России.

С нами вы становитесь еще успешнее!

Наши контакты:

Телефон: +7 812 627 14 35

Электронная почта: sales@st-electron.ru

Адрес: 198099, Санкт-Петербург,
Промышленная ул, дом № 19, литера Н,
помещение 100-Н Офис 331