

Push-on Bayonet Lock Miniature Waterproof Connector

HR34B Series

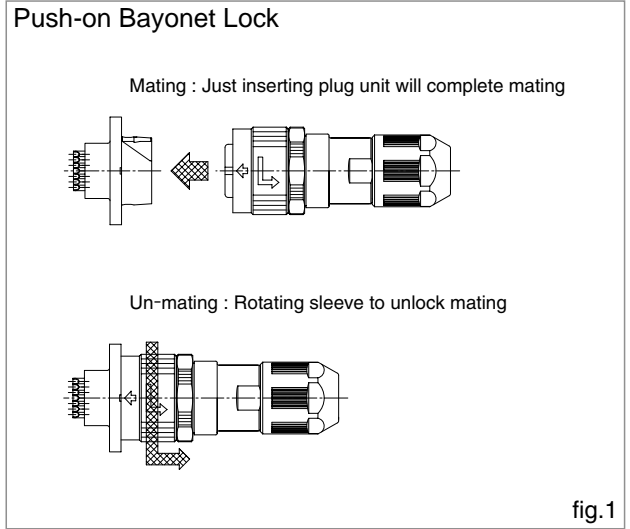

■Features

1. Water and dust protection

- IP67 or more (IP68) water and dust protection rating when fully mated.
- Resistant to industrial grade oils.
- 4-position receptacles are sealed against water penetration when mounted on the panel - no protective cap is required.

2. Easy and precise mating

- Mating: Just inserting plug unit completes mating
Unmating: Rotating sleeve counterclockwise unlocks connectors (fig.1)
- Marking helps align plug with receptacle when mating.
- 3 guide keys make blind mating possible.
(Receptacle structure prevents plug from damaging receptacle terminals)

3. Multi-directional cable exit

Right angle plugs allow the cable to exit in 8 directions, in 45° increments.(fig.2)

4. Safty standards

The 4-position connectors meet requirements of TÜV standard.

5. Wide variation

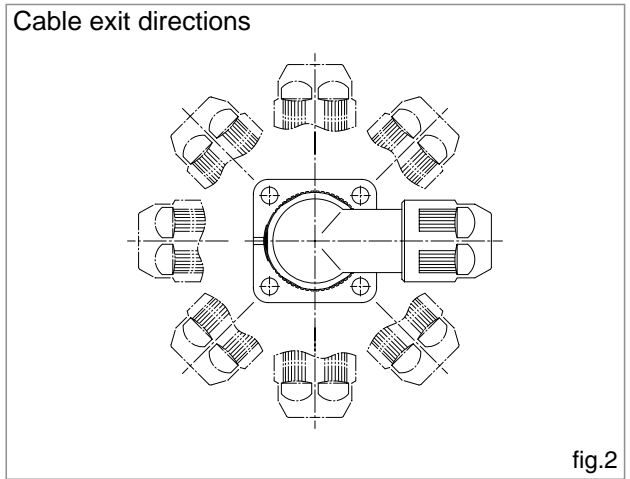

Item	
Number of positions	4,10
Connector type	straight plug,right angle plug,receptacle
Terminations(plug)	solder,crimp
Terminations(receptacle)	wire solder
Conduit material	plastic,metal
Applicable cable size(Reference)	(ϕ 5.3~6.5), (ϕ 6.5~7.3), (ϕ 8.0~9.0)

■ Specifications

Ratings	Current rating	10 pos.: 3 A 4 pos. : 5 A	Operating temperature range	-25°C to 125°C
	Voltage rating	10 pos.: 200 V AC, 250 V DC 4 pos. : 200 V AC, 200 V DC (contamination level 3) 400 V AC, 400 V DC (contamination level 2)	Storage temperature range	-25°C to 85°C

Item	Specification	Conditions
1.Contact resistance	20 mΩ max.	1 A DC
2.Insulation resistance	1,000 MΩ min.	500 V DC
3.Withstanding voltage	No flashover or insulation breakdown	10 pos. : 900 V AC / 1 minute 4 pos. : 2,000 V AC / 1 minute
4.Vibration	No electrical discontinuity of 10 μs or longer	Frequency: 10 to 500 Hz/cycle, total amplitude of 0.75 mm, 98m/s ² each, 3 hours in 3 axis.
5.Shock	No electrical discontinuity of 10 μs or longer	Acceleration of 490 m/s ² , 11 ms duration, 3 axis, each for 3 hours
6.Durability (Mating / un-mating)	Contact resistance: 30 mΩ max.	500 cycles
7.Temperature cycle	Insulation resistance: 500 MΩ min.	Temperature : -55°C → +15° to +35°C → +85°C → +15° to +35°C Time : 30 min. → 10 to 15 min. → 30 min. → 10 to 15 min. 5 cycles
8.Humidity	Insulation resistance: 50 MΩ min. (at high humidity) Insulation resistance: 500 MΩ min. (when dry)	336 hours at 71°C, and humidity of 95%
9.Water protection	No water penetration when submerged for 0.5 hours at the depth of 1 meters.	

■ Materials

● Plugs

Part	Material	Finish	Remarks
Outer shell	Zinc alloy, aluminum alloy, and polyamide resin (black)	Black chrome plating, black chromate finish (Cr +3)	_____
Insulator	PPS	Color: Black	UL94V-0
Female contacts	10 pos.	Phosphor bronze	Gold plated
	4 pos.	Copper alloy	Silver plated
O-ring Gasket	Fluororubber, Nitrile hydride rubber	_____	_____

● Receptacles

Part	Material	Finish	Remarks
Outer shell	Zinc alloy	Black chromate finish (Cr +3)	_____
Insulator	PPS	Color: Black	UL94V-0
Male contacts	10 pos.	Copper alloy	Gold plated
	4 pos.	Brass	Silver plated
Ground contact	4 pos.	Brass	Silver plated
O-ring	Fluororubber	_____	_____

■ Ordering information

Please determine the specific product. If listed needed, please select and order the product No.

● Plugs

HR34B - 12 WP A - 10 S - X ()**

① ② ③ ④ ⑤ ⑥ ⑦ ⑧

① Series name : HR34B Series	⑤ Number of contact : Number of contacts. (Excluding ground contacts)
② Shell size : Diameter(mm) of the mating interface of the plug	⑥ Contact type S : Female wire solder SC : Female crimp
③ Shell style WP : Straight plug WLP : Right-angle plug	
④ Conduit material and Applicable cable size A:Conduit material metal, Applicable cable (Reference):(φ5.3~6.5) B:Conduit material metal, Applicable cable (Reference):(φ6.5~7.3) D:Conduit material plastic, Applicable cable (Reference):(φ5.7~6.5) E:Conduit material plastic, Applicable cable (Reference):(φ6.5~7.3) K:Conduit material metal, Applicable cable (Reference):(φ8.0~9.0)	⑦ Keying Blank : Standard X : X key position
	⑧ Other specifications : 2 numerical digits will be added when there is a specifications change other than shown in positions ① to ⑦

● Receptacles

HR34B - 12 WR A - 10 P - X ()**

① ② ③ ④ ⑤ ⑥ ⑦ ⑧

① Series name : HR34B Series	⑤ Number of contact : Number of contacts. (Excluding ground contacts)
② Shell size : Diameter(mm) of the mating interface of the plug	⑥ Contact type P : Male,wire solder
③ Shell style WR : Receptacl	
④ Shell type A : Square flange for 10 positions B : Square flange for 4 positions	⑦ Keying Blank : Standard X : X key position
	⑧ Other specifications : 2 numerical digits will be added when there is a specification change other than shown in positions ① to ⑦

● Crimp contacts

HR34B - SC1 - 2 1 1

① ② ③ ④ ⑤

① Series name : HR34B Series	④ Conductor size : AWG#20 - #25
② Contact style : SC1:Female contact	⑤ Plating 1:Gold plated
③ Contact type 1 : 100pcs.per bag 2 : 10,000pcs per reel	

■Straight plugs

●Standard type (Conduit material :Plastic)

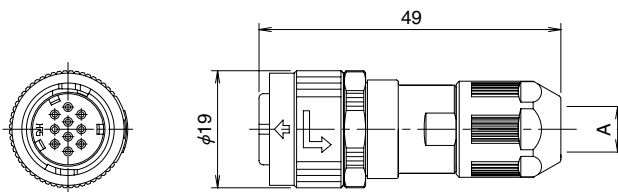

◆Wire solder

All dimensions: mm

Part Number	HRS No.	A	Applicable cable diameter range(Reference)	Solder cup inner diameter
HR34B-12WPD-10S	134-0026-0-00	φ7.4	(φ5.7~6.5)	φ1
HR34B-12WPE-10S	134-0027-2-00	φ8.5	(φ6.5~7.3)	
HR34B-12WPD-4S	134-0020-3-00	φ7.4	(φ5.7~6.5)	φ1.7
HR34B-12WPD-4S-X	134-0023-1-00			
HR34B-12WPE-4S	134-0025-7-00	φ8.5	(φ6.5~7.3)	
HR34B-12WPE-4S-X	134-0031-0-00			

◆Crimp (separate contacts required)

Part Number	HRS No.	A	Applicable cable diameter range(Reference)
HR34B-12WPD-10SC	134-0037-6-00	φ7.4	(φ5.7~6.5)
HR34B-12WPE-10SC	134-0038-9-00	φ8.5	(φ6.5~7.3)

●Robust type(Conduit material :Metal)

◆Wire solder

All dimensions: mm

Part Number	HRS No.	A	Applicable cable diameter range(Reference)	Solder cup inner diameter
HR34B-12WPA-10S(71)	134-0004-7-71	φ7.4	(φ5.7~6.5)	φ1
HR34B-12WPB-10S(71)	134-0007-5-71	φ8.5	(φ6.5~7.3)	
HR34B-12WPK-10S	134-0052-0-00	φ9.5	(φ8.0~9.0)	

◆Crimp (separate contacts required)

Part Number	HRS No.	A	Applicable cable diameter range(Reference)
HR34B-12WPA-10SC	134-0017-9-00	φ7.4	(φ5.7~6.5)
HR34B-12WPB-10SC	134-0028-5-00	φ8.5	(φ6.5~7.3)
HR34B-12WPK-10SC	134-0053-2-00	φ9.5	(φ8.0~9.0)

Not all cables of applicable dia. range can be easily assembled.
Please kindly check with factory before use.

◆Illustrations of mated connectors.

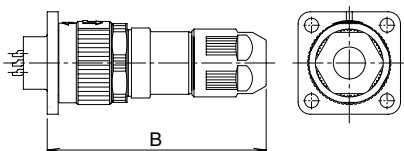

Straight plug Mating combinations	B
10 pos.plug + receptacle wire solder	50.1
4 pos.plug + receptacle wire solder	49.6

■ Right angle plugs

● Standard type (Conduit material : Plastic)

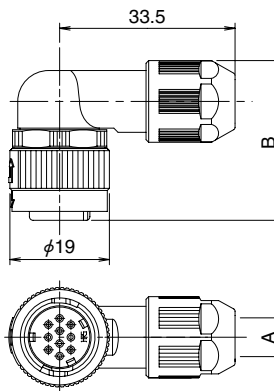
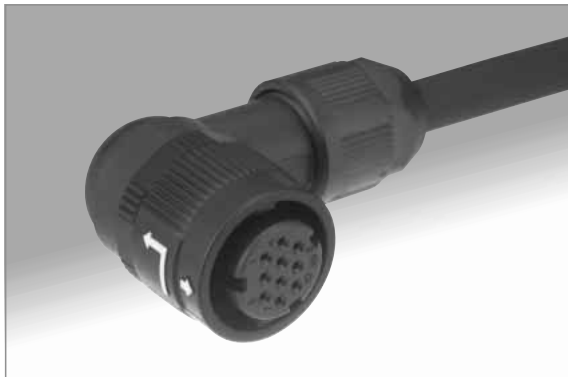

◆ Wire solder

All dimensions: mm

Part Number	HRS No.	A	B	Applicable cable diameter range(Reference)	Solder cup inner diameter
HR34B-12WLPD-10S	134-0039-1-00	φ7.4	30.85	(φ5.7~6.5)	φ1
HR34B-12WLPE-10S	134-0040-0-00	φ8.5		(φ6.5~7.3)	
HR34B-12WLPD-4S	134-0030-7-00	φ7.4		(φ5.7~6.5)	φ1.7
HR34B-12WLPD-4S-X	134-0034-8-00			(φ6.5~7.3)	
HR34B-12WLPE-4S	134-0035-0-00	φ8.5		(φ5.7~6.5)	
HR34B-12WLPE-4S-X	134-0036-3-00			(φ6.5~7.3)	

◆ Crimp (separate contacts required)

Part Number	HRS No.	A	B	Applicable cable diameter range(Reference)
HR34B-12WLPD-10SC	134-0041-3-00	φ7.4	30.85	(φ5.7~6.5)
HR34B-12WLPE-10SC	134-0042-6-00	φ8.5		(φ6.5~7.3)

● Robust type (Conduit material :Metal)

◆ Wire solder

Part Number	HRS No.	A	B	Applicable cable diameter range(Reference)	Solder cup inner diameter
HR34B-12WLPA-10S(71)	134-0005-0-71	φ7.4	30.5	(φ5.7~6.5)	φ1
HR34B-12WLPA-10S(71)	134-0008-8-71	φ8.5		(φ6.5~7.3)	
HR34B-12WLPA-10S(71)	134-0008-8-71	φ9.5	31.5	(φ8.0~9.0)	

● Crimp (separate contacts required)

Part Number	HRS No.	A	B	Applicable cable diameter range(Reference)
HR34B-12WLPA-10SC	134-0018-1-00	φ7.4	30.5	(φ5.7~6.5)
HR34B-12WLPA-10SC	134-0029-8-00	φ8.5		(φ6.5~7.3)
HR34B-12WLPA-10SC	134-0055-8-00	φ9.5	31.5	(φ8.0~9.0)

Not all cables of applicable dia. range can be easily assembled.
Please kindly check with factory before use.

◆ Illustrations of mated connectors.

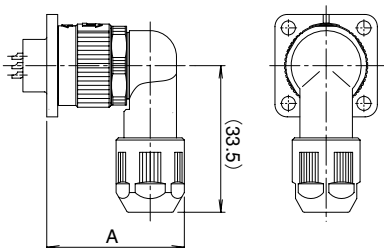

Right-angle plug Mating Combinations		A
10 pos. plug shell A,B type.	Plug + receptacle wire solder	31.0
10 pos. plug shell D,E type.	Plug + receptacle wire solder	31.3
10 pos. plug shell K type.	Plug + receptacle wire solder	32.0
4 pos. plug + receptacle wire solder		31.3

■ Receptacles

◆ Wire solder

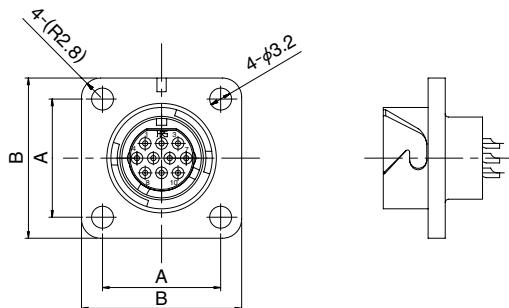
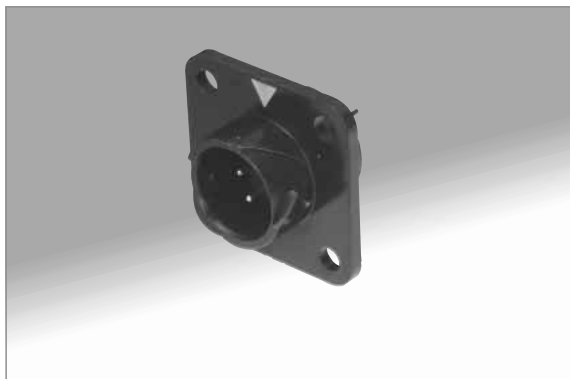

All dimensions: mm

Part Number	HRS No.	A	B	Solder cup inner diameter
HR34B-12WRA-10P	134-0016-6-00	17.26	23.4	φ1
HR34B-12WRB-4P	134-0021-6-00	18.26	25.4	φ1.4
HR34B-12WRB-4P-X	134-0024-4-00			

O ring for water proof is not attached. Please find appropriate one from the market.

◆ Recommended panel cutouts

● Receptacle - wire solder

All dimensions: mm

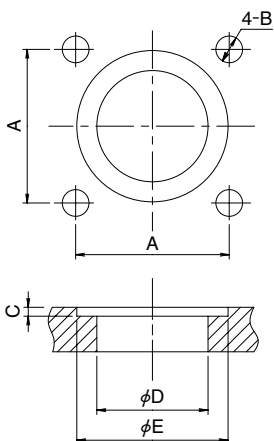

	HR34B-12WRA-10P	HR34B-12WRB-4P HR34B-12WRB-4P-X
A	17.26±0.05	18.26±0.05
B	M3×0.5	
C	1.0/-0.1	1.1 0/-0.1
D	12.5 +0.1/0	16.3 +0.1/0
E	17 +0.1/0	20.8 +0.1/0

Recommended O ring dia.

Part Number	Cross-section	diameter
HR34B-12WRA-10P	1.5	11.5
HR34B-12WRB-4P	1.5	15.5
HR34B-12WRB-4P-X		

◆ Receptacle Contact Arrangement

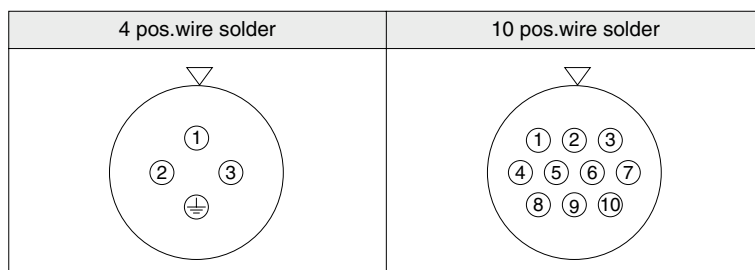

note.1 View direction: Mating surface of pin insert.

note.2 ⊕ mark is ground terminal.

■ Crimp contacts

◆ Female

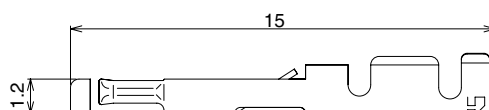

Part Number	CL No.	Packaging	Applicable conductor
HR34B-SC1-111	134-0051-7-00	100 pcs. per bag	AWG #20 - 25 (Stranded wire)
HR34B-SC1-211	134-0050-4-00	10,000 pcs. per reel	

Note: Use wire with a jacket diameter of 1.7mm max.

◆ Connector Mating Combinations

10 pos. Plugs

Straight, Wire Solder or Crimp (Standard key position)
 HR34B-12WPA-10S,10SC HR34B-12WPB-10S,10SC
 HR34B-12WPD-10S,10SC HR34B-12WPE-10S,10SC
 HR34B-12WPK-10S,10SC

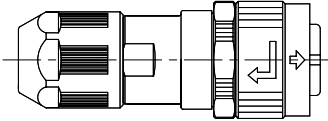

Right angle, Wire Solder or Crimp (Standard key position)
 HR34B-12WLP A-10S,10SC HR34B-12WLPB-10S,10SC
 HR34B-12WLPD-10S,10SC HR34B-12WLPE-10S,10SC
 HR34B-12WLPK-10S,10SC

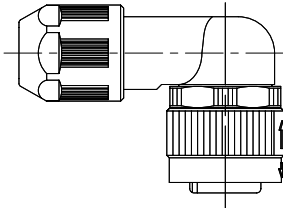

10 pos. Receptacles

Wire Solder
 HR34B-12WRA-10P

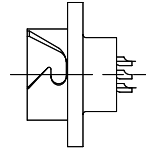

4 pos. Plugs

Straight, Wire Solder (Standard key position)
 HR34B-12WPD-4S
 HR34B-12WPE-4S

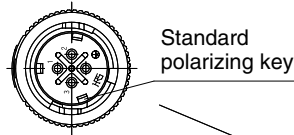
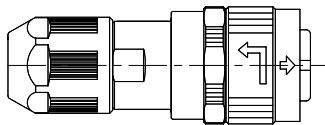

Right angle, Wire Solder (Standard key position)
 HR34B-12WLPD-4S
 HR34B-12WLPE-4S

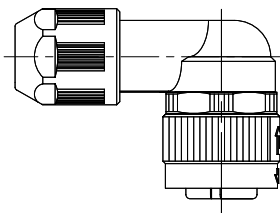

4 pos. Receptacles

Wire solder (Standard key position)
 HR34B-12WRB-4P

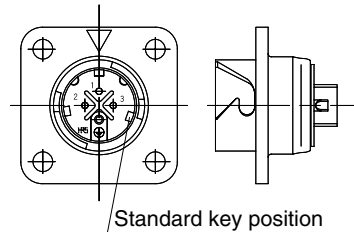

Straight, Wire Solder (X key position)
 HR34B-12WPD-4S-X
 HR34B-12WPE-4S-X

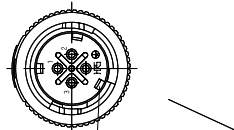
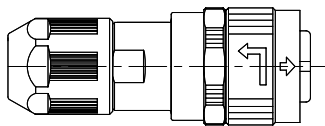

Right angle, Wire Solder (X key position)
 HR34B-12WLPD-4S-X
 HR34B-12WLPE-4S-X

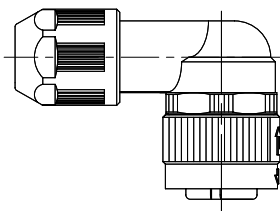

Wire solder (X key position)
 HR34B-12WRB-4P-X

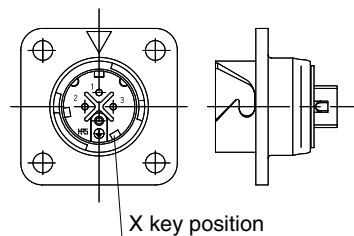

■Applicable tools

Description	Part Number	CL No.	Applicable contact	Applicable cable
Manual contact crimping tool	HT304/HR34B-1	150-0107-9	HR34B-SC1-111	AWG20,AWG23,AWG25
Press	CM-105	901-0005-4	HR34B-SC1-211	AWG20 to AWG25
Applicator	AP105-HR34B-1	901-2051-2		
Contact extraction tool	RP6-SC-TP	150-0039-0	HR34B-SC1-111	—————
			HR34B-SC1-211	

●Manual contact crimping tool



●Press CM-105 (Applicator ordered separate)



●Contact extraction tool

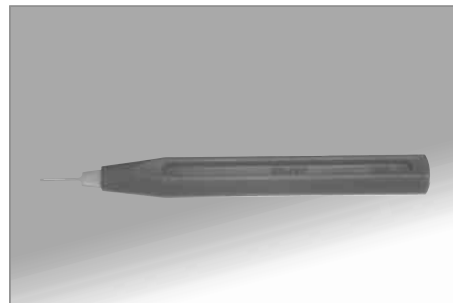

◆Handling

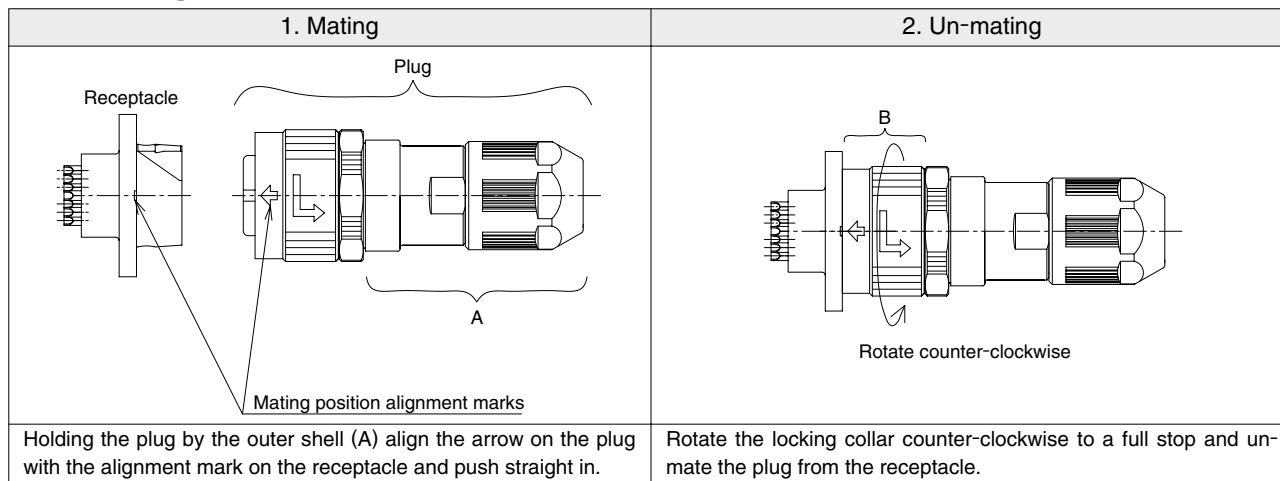

◆Precautions

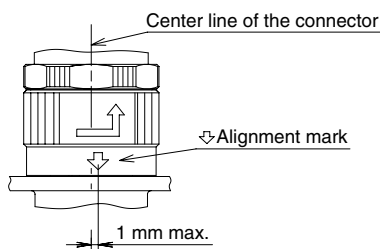

When completely mated and locked the alignment arrow on the plug must line-up with the center line of the connector (alignment mark on the receptacle).

If the alignment arrow and the center line of the connectors are not aligned (1 mm max.) re-insert the plug until they are aligned.

1. When disconnecting or inserting the connector, be sure to do so after turning off the power.
2. To insert the connector, push it in until the arrow tip of the plug mating mark indicates the specified position of the diagram below (i.e., the mating mark of the receptacle).
3. Note that the display method of the mating mark will differ depending on the receptacle.
4. To maintain the waterproof quality and cable clamp force, use a cable that is within the range of the applicable cable diameter.
5. Please consult Hirose Electric Sales for harness assembly procedure.



HRS

HIROSE ELECTRIC CO.,LTD.

5-23,OSAKI 5-CHOME,SHINAGAWA-KU,TOKYO 141-8587,JAPAN

PHONE: 81-3-3491-5300, FAX: 81-3-3495-5230

<http://www.hirose.com>

<http://www.hirose-connectors.com>



Стандарт Электрон Связь

Мы молодая и активно развивающаяся компания в области поставок электронных компонентов. Мы поставляем электронные компоненты отечественного и импортного производства напрямую от производителей и с крупнейших складов мира.

Благодаря сотрудничеству с мировыми поставщиками мы осуществляем комплексные и плановые поставки широчайшего спектра электронных компонентов.

Собственная эффективная логистика и склад в обеспечивает надежную поставку продукции в точно указанные сроки по всей России.

Мы осуществляем техническую поддержку нашим клиентам и предпродажную проверку качества продукции. На все поставляемые продукты мы предоставляем гарантию .

Осуществляем поставки продукции под контролем ВП МО РФ на предприятия военно-промышленного комплекса России , а также работаем в рамках 275 ФЗ с открытием отдельных счетов в уполномоченном банке. Система менеджмента качества компании соответствует требованиям ГОСТ ISO 9001.

Минимальные сроки поставки, гибкие цены, неограниченный ассортимент и индивидуальный подход к клиентам являются основой для выстраивания долгосрочного и эффективного сотрудничества с предприятиями радиоэлектронной промышленности, предприятиями ВПК и научно-исследовательскими институтами России.

С нами вы становитесь еще успешнее!

Наши контакты:

Телефон: +7 812 627 14 35

Электронная почта: sales@st-electron.ru

Адрес: 198099, Санкт-Петербург,
Промышленная ул, дом № 19, литера Н,
помещение 100-Н Офис 331