

## PWM Fan Speed Controller with Auto-Shutdown and FanSense™ Technology

### Features

- Temperature Proportional Fan Speed for Acoustic Control and Longer Fan Life
- Efficient PWM Fan Drive
- 3.0V to 5.5V Supply Range:
  - Fan Voltage Independent of TC646 Supply Voltage
  - Supports any Fan Voltage
- FanSense™ Fault Detection Circuits Protect Against Fan Failure and Aid System Testing
- Shutdown Mode for "Green" Systems
- Supports Low Cost NTC/PTC Thermistors
- Space Saving 8-Pin MSOP Package
- Over-temperature Indication

### Applications

- Power Supplies
- Computers
- File Servers
- Portable Computers
- Telecom Equipment
- UPS, Power Amps
- General Purpose Fan Speed Control

### Available Tools

- Fan Controller Demonstration Board (TC642DEMO)
- Fan Controller Evaluation Kit (TC642EV)

### Package Types

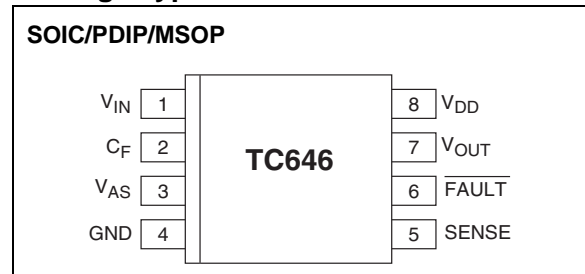

### General Description

The TC646 is a switch mode, fan speed controller for use with brushless DC fans. Temperature proportional speed control is accomplished using pulse width modulation (PWM). A thermistor (or other voltage output temperature sensor) connected to the  $V_{IN}$  input furnishes the required control voltage of 1.25V to 2.65V (typical) for 0% to 100% PWM duty cycle. The TC646 automatically suspends fan operation when measured temperature ( $V_{IN}$ ) is below a user programmed minimum setting ( $V_{AS}$ ). An integrated Start-up Timer ensures reliable motor start-up at turn-on, coming out of shutdown mode, auto-shutdown mode or following a transient fault.

The TC646 features Microchip Technology's proprietary FanSense™ technology for increasing system reliability. In normal fan operation, a pulse train is present at SENSE (Pin 5). A missing-pulse detector monitors this pin during fan operation. A stalled, open, or unconnected fan causes the TC646 to trigger its Start-up Timer once. If the fault persists, the FAULT output goes low and the device is latched in its shutdown mode. FAULT is also asserted if the PWM reaches 100% duty cycle, indicating a possible thermal runaway situation, although the fan continues to run. See Section 5.0, "Typical Applications", for more information and system design guidelines.

The TC646 is available in the 8-pin plastic DIP, SOIC and MSOP packages and is available in the industrial and extended commercial temperature ranges.

# TC646

## Functional Block Diagram

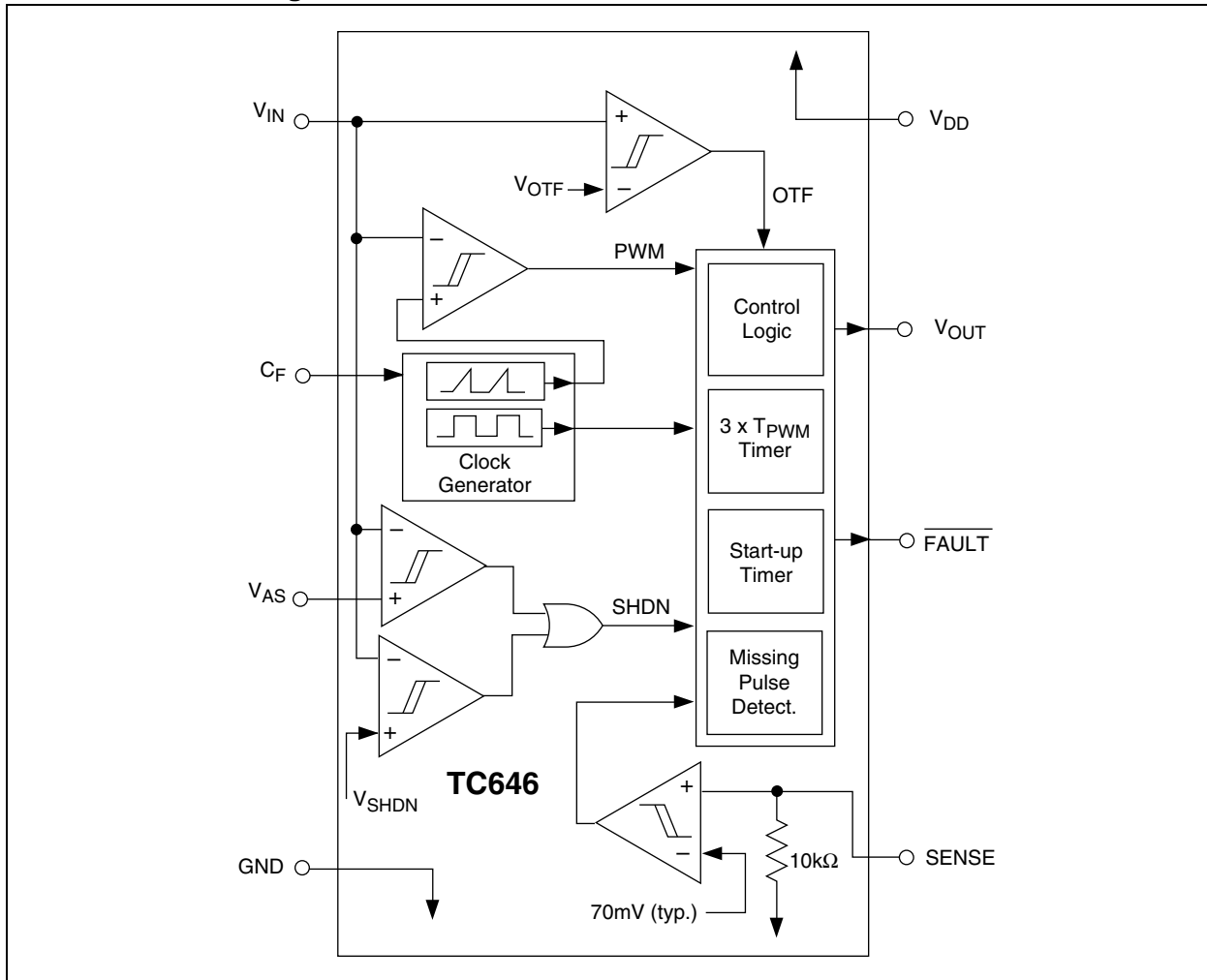

## 1.0 ELECTRICAL CHARACTERISTICS

### Absolute Maximum Ratings\*

Supply Voltage .....	6V
Input Voltage, Any Pin..... (GND – 0.3V) to (V <sub>DD</sub> +0.3V)	
Package Thermal Resistance:	
PDIP (R <sub>θJA</sub> ).....	125°C/W
SOIC (R <sub>θJA</sub> ).....	155°C/W
MSOP (R <sub>θJA</sub> ).....	200°C/W
Specified Temperature Range.....	-40°C to +125°C
Storage Temperature Range.....	-65°C to +150°C

\*Stresses above those listed under "Absolute Maximum Ratings" may cause permanent damage to the device. These are stress ratings only and functional operation of the device at these or any other conditions above those indicated in the operation sections of the specifications is not implied. Exposure to absolute maximum rating conditions for extended periods may affect device reliability.

### DC ELECTRICAL SPECIFICATIONS

Electrical Characteristics: Unless otherwise specified, T <sub>MIN</sub> ≤ T <sub>A</sub> ≤ T <sub>MAX</sub> , V <sub>DD</sub> = 3.0V to 5.5V						
Symbol	Parameter	Min	Typ	Max	Units	Test Conditions
V <sub>DD</sub>	Supply Voltage	3.0	—	5.5	V	
I <sub>DD</sub>	Supply Current, Operating	—	0.5	1.0	mA	Pins 6, 7 Open, C <sub>F</sub> = 1 μF, V <sub>IN</sub> = V <sub>C(MAX)</sub>
I <sub>DD(SHDN)</sub>	Supply Current, Shutdown/ Auto-shutdown Mode	—	25	—	μA	Pins 6, 7 Open; <b>Note 1</b> C <sub>F</sub> = 1 μF, V <sub>IN</sub> = 0.35V
I <sub>IN</sub>	V <sub>IN</sub> , V <sub>AS</sub> Input Leakage	-1.0	—	+1.0	μA	<b>Note 1</b>
<b>V<sub>OUT</sub> Output</b>						
t <sub>R</sub>	V <sub>OUT</sub> Rise Time	—	—	50	μsec	I <sub>OH</sub> = 5 mA, <b>Note 1</b>
t <sub>F</sub>	V <sub>OUT</sub> Fall Time	—	—	50	μsec	I <sub>OL</sub> = 1 mA, <b>Note 1</b>
t <sub>SHDN</sub>	Pulse Width(On V <sub>IN</sub> ) to Clear Fault Mode	30	—	—	μsec	V <sub>SHDN</sub> , V <sub>HYST</sub> Specifications, <b>Note 1</b>
I <sub>OL</sub>	Sink Current at V <sub>OUT</sub> Output	1.0	—	—	mA	V <sub>OL</sub> = 10% of V <sub>DD</sub>
I <sub>OH</sub>	Source Current at V <sub>OUT</sub> Output	5.0	—	—	mA	V <sub>OH</sub> = 80% of V <sub>DD</sub>
<b>SENSE Input</b>						
V <sub>TH(SENSE)</sub>	SENSE Input Threshold Voltage with Respect to GND	50	70	90	mV	<b>Note 1</b>
<b>FAULT Output</b>						
V <sub>OL</sub>	Output Low Voltage	—	—	0.3	V	I <sub>OL</sub> = 2.5 mA
t <sub>MP</sub>	Missing Pulse Detector Timer	—	32/F	—	Sec	C <sub>F</sub> = 1.0 μF
t <sub>STARTUP</sub>	Start-up Timer	—	32/F	—	Sec	C <sub>F</sub> = 1.0 μF
t <sub>DIAG</sub>	Diagnostic Timer	—	3/F	—	Sec	C <sub>F</sub> = 1.0 μF

**Note 1:** Ensured by design, not tested.

# TC646

## DC ELECTRICAL SPECIFICATIONS (CONTINUED)

Electrical Characteristics: Unless otherwise specified, $T_{MIN} \leq T_A \leq T_{MAX}$ , $V_{DD} = 3.0V$ to $5.5V$						
Symbol	Parameter	Min	Typ	Max	Units	Test Conditions
<b><math>V_{IN}</math>, <math>V_{AS}</math> Inputs</b>						
$V_{C(MAX)}, V_{OTF}$	Voltage at $V_{IN}$ for 100% Duty Cycle and Overtemp. Fault	2.5	2.65	2.8	V	
$V_{C(SPAN)}$	$V_{C(MAX)} - V_{C(MIN)}$	1.3	1.4	1.5	V	
$V_{AS}$	Auto-shutdown Threshold	$V_{C(MAX)} - V_{C(SPAN)}$	—	$V_{C(MAX)}$	V	
$V_{SHDN}$	Voltage Applied to $V_{IN}$ to ensure Reset/Shutdown	—	—	$V_{DD} \times 0.13$	V	
$V_{REL}$	Voltage Applied to $V_{IN}$ to Release Reset Mode	$V_{DD} \times 0.19$	—	—	V	$V_{DD} = 5V$ , See Figure 5-11
$V_{HYST}$	Hysteresis on $V_{SHDN}$ , $V_{REL}$	—	$0.01 \times V_{DD}$	—	V	
$V_{HAS}$	Hysteresis on Auto-shutdown Comparator	—	70	—	mV	
<b>Pulse Width Modulator</b>						
$F_{OSC}$	PWM Frequency	26	30	34	Hz	$C_F = 1.0 \mu F$

**Note 1:** Ensured by design, not tested.

## 2.0 PIN DESCRIPTIONS

The descriptions of the pins are listed in Table 2-1.

**TABLE 2-1: PIN FUNCTION TABLE**

Pin No.	Symbol	Description
1	$V_{IN}$	Analog Input
2	$C_F$	Analog Output
3	$V_{AS}$	Analog Input
4	GND	Ground Terminal
5	SENSE	Analog Input
6	$\overline{FAULT}$	Digital (Open Collector) Output
7	$V_{OUT}$	Digital Output
8	$V_{DD}$	Power Supply Input

### 2.1 Analog Input ( $V_{IN}$ )

The thermistor network (or other temperature sensor) connects to the  $V_{IN}$  input. A voltage range of 1.25V to 2.65V (typical) on this pin drives an active duty cycle of 0% to 100% on the  $V_{OUT}$  pin. The TC646 enters shutdown mode when  $V_{IN} \leq V_{SHDN}$ . During shutdown, the  $\overline{FAULT}$  output is inactive, and supply current falls to 25  $\mu$ A (typical). The TC646 exits shutdown mode when  $V_{IN} \geq V_{REL}$  (see Section 5.0, "Typical Applications", for details).

### 2.2 Analog Output ( $C_F$ )

$C_F$  is the positive terminal for the PWM ramp generator timing capacitor. The recommended  $C_F$  is 1  $\mu$ F for 30 Hz PWM operation.

### 2.3 Analog Input ( $V_{AS}$ )

An external resistor divider connected to the  $V_{AS}$  input sets the auto-shutdown threshold. Auto-shutdown occurs when  $V_{IN} \leq V_{AS}$ . The fan is automatically restarted when  $V_{IN} \geq (V_{AS} + V_{HAS})$  (see Section 5.0, "Typical Applications", for more details).

### 2.4 Ground (GND)

GND denotes the ground terminal.

### 2.5 Analog Input (SENSE)

Pulses are detected at the SENSE pin as fan rotation chops the current through a sense resistor ( $R_{SENSE}$ ). The absence of pulses indicates a fault (see Section 5.0, "Typical Applications", for more details).

### 2.6 Digital Output ( $\overline{FAULT}$ )

The  $\overline{FAULT}$  line goes low to indicate a fault condition. When  $\overline{FAULT}$  goes low due to a fan fault condition, the device is latched in shutdown mode until deliberately cleared or until power is cycled.  $\overline{FAULT}$  will also be asserted when the PWM reaches 100% duty cycle, indicating that maximum cooling capability has been reached and a possible over-temperature condition may occur. This is a non-latching state and the  $\overline{FAULT}$  output will go high when the PWM duty cycle goes below 100%.

### 2.7 Digital Output ( $V_{OUT}$ )

$V_{OUT}$  is an active high complimentary output that drives the base of an external NPN transistor (via an appropriate base resistor) or the gate of an N-channel MOSFET. This output has asymmetrical drive (see Section 1.0, "Electrical Characteristics").

### 2.8 Power Supply Input ( $V_{DD}$ )

$V_{DD}$  may be independent of the fan's power supply (see Section 1.0, "Electrical Characteristics").

## 3.0 DETAILED DESCRIPTION

### 3.1 PWM

The PWM circuit consists of a ramp generator and threshold detector. The frequency of the PWM is determined by the value of the capacitor connected to the  $C_F$  input. A frequency of 30 Hz is recommended ( $C_F = 1 \mu\text{F}$ ). The PWM is also the time base for the Start-up Timer (see Section 3.3, "Start-Up Timer"). The PWM voltage control range is 1.25V to 2.65V (typical) for 0% to 100% output duty cycle.

### 3.2 $V_{\text{OUT}}$ Output

The  $V_{\text{OUT}}$  pin is designed to drive a low cost transistor or MOSFET as the low side, power switching element in the system. Various examples of driver circuits will be shown throughout this data sheet. This output has asymmetric complementary drive and is optimized for driving NPN transistors or N-channel MOSFETs. Since the system relies on PWM rather than linear control, the power dissipation in the power switch is kept to a minimum. Generally, very small devices (TO-92 or SOT packages) will suffice.

### 3.3 Start-Up Timer

To ensure reliable fan start-up, the Start-up Timer turns the  $V_{\text{OUT}}$  output on for 32 cycles of the PWM whenever the fan is started from the off state. This occurs at power-up and when coming out of shutdown or auto-shutdown mode. If the PWM frequency is 30 Hz ( $C_F = 1 \mu\text{F}$ ), the resulting start-up time will be approximately one second. If a fan fault is detected, the Diagnostic Timer is triggered once, followed by the Start-up Timer. If the fault persists, the device is shut down (see Section 3.5, "FAULT Output").

### 3.4 SENSE Input (FanSense™ Technology)

The SENSE input (Pin 5) is connected to a low value current sensing resistor in the ground return leg of the fan circuit. During normal fan operation, commutation occurs as each pole of the fan is energized. This causes brief interruptions in the fan current, seen as pulses across the sense resistor. If the device is not in auto-shutdown or shutdown mode, and pulses are not appearing at the SENSE input, a fault exists.

The short, rapid change in fan current (high  $dI/dt$ ) causes a corresponding  $dV/dt$  across the sense resistor,  $R_{\text{SENSE}}$ . The waveform on  $R_{\text{SENSE}}$  is differentiated and converted to a logic-level pulse-train by  $C_{\text{SENSE}}$  and the internal signal processing circuitry. The presence and frequency of this pulse-train is a direct indication of fan operation. See Section 5.0, "Typical Applications", for more details.

### 3.5 FAULT Output

The TC646 detects faults in two ways:

First, pulses appearing at SENSE due to the PWM turning on are blanked, with the remaining pulses being filtered by a missing pulse detector. If consecutive pulses are not detected for thirty-two PWM cycles ( $\cong 1 \text{ Sec}$  if  $C_F = 1 \mu\text{F}$ ), the Diagnostic Timer is activated and  $V_{\text{OUT}}$  is driven high continuously for three PWM cycles ( $\cong 100 \text{ msec}$  if  $C_F = 1 \mu\text{F}$ ). If a pulse is not detected within this window, the Start-up Timer is triggered (see Section 3.3, "Start-up Timer"). This should clear a transient fault condition. If the missing pulse detector times out again, the PWM is stopped and  $\overline{\text{FAULT}}$  goes low. When  $\overline{\text{FAULT}}$  is activated due to this condition, the device is latched in shutdown mode and will remain off indefinitely. Therefore, the TC646 is prevented from attempting to drive a fan under catastrophic fault conditions.

One of two things will restore operation: Cycling power off and then on again or pulling  $V_{\text{IN}}$  below  $V_{\text{SHDN}}$  and releasing it to a level above  $V_{\text{REL}}$ . When one of these two conditions is satisfied, the normal start-up cycle is triggered and operation will resume if the fault has been cleared.

The second condition by which the TC646 asserts a  $\overline{\text{FAULT}}$  is when the PWM control voltage applied to  $V_{\text{IN}}$  becomes greater than that needed to drive 100% duty cycle (see Section 1.0, "Electrical Characteristics"). This indicates that the fan is at maximum drive and the potential exists for system overheating. Either heat dissipation in the system has gone beyond the cooling system's design limits or some subtle fault exists (such as fan bearing failure or an airflow obstruction). This output may be treated as a "System Overheat" warning and be used to trigger system shutdown or some other corrective action.

However, in this case, the fan will continue to run even when  $\overline{\text{FAULT}}$  is asserted. If the system is allowed to continue operation, and the temperature (and thus  $V_{\text{IN}}$ ) falls, the  $\overline{\text{FAULT}}$  output will become inactive when  $V_{\text{IN}} < V_{\text{OTF}}$ .

### 3.6 Auto-Shutdown Mode

If the voltage on  $V_{\text{IN}}$  becomes less than the voltage on  $V_{\text{AS}}$ , the fan is automatically shut off (auto-shutdown mode). The TC646 exits auto-shutdown mode when the voltage on  $V_{\text{IN}}$  becomes higher than the voltage on  $V_{\text{AS}}$  by  $V_{\text{HAS}}$  (the auto-shutdown Hysteresis Voltage (see Figure 3-1)). The Start-up Timer is triggered and normal operation is resumed upon exiting auto-shutdown mode. The  $\overline{\text{FAULT}}$  output is unconditionally inactive in auto-shutdown mode.



**FIGURE 3-1:** TC646 Nominal Operation.

### 3.7 Shutdown Mode (Reset)

If an unconditional shutdown and/or device reset is desired, the TC646 may be placed in shutdown mode by forcing  $V_{IN}$  to a logic low (i.e.,  $V_{IN} < V_{SHDN}$ ) (see Figure 3-1). In this mode, all functions cease and the  $\overline{FAULT}$  output is unconditionally inactive. The TC646 should not be shut down unless all heat producing activity in the system is at a negligible level. The TC646 exits shutdown mode when  $V_{IN}$  becomes greater than  $V_{REL}$ , the release voltage.

Entering shutdown mode also performs a complete device reset. Shutdown mode resets the TC646 into its power-up state. The Start-up and Fault Timers, and any current faults, are cleared.  $\overline{FAULT}$  is unconditionally inactive in shutdown mode. Upon exiting shutdown mode ( $V_{IN} > V_{REL}$ ), the Start-up Timer will be triggered and normal operation will resume, assuming no fault conditions exist and  $V_{IN} > V_{AS} + V_{HAS}$ .

**Note:** If  $V_{IN} < V_{AS}$  when the device exits shutdown mode, the fan will not restart as it will be in auto-shutdown mode.

If a fan fault has occurred and the device has latched itself into shutdown mode, performing a reset will not clear the fault unless  $V_{IN} > (V_{AS} + V_{HAS})$ . If  $V_{IN}$  is not greater than  $(V_{AS} + V_{HAS})$  upon exiting shutdown mode, the fan will not be restarted. Consequently, there is no way to establish that the fan fault has been cleared. To ensure that a complete reset takes place, the user's circuitry must ensure that  $V_{IN} > (V_{AS} + V_{HAS})$  when the device is released from shutdown mode. A recommended algorithm for management of the TC646 by a host microcontroller or other external circuitry is given in Section 5.0, "Typical Applications". A small amount of hysteresis, typically one percent of  $V_{DD}$  (50 mV at  $V_{DD} = 5.0V$ ), is designed into the  $V_{SHDN}/V_{REL}$  threshold. The levels specified for  $V_{SHDN}$  and  $V_{REL}$  in Section 1.0, "Electrical Characteristics", include this hysteresis plus adequate margin to account for normal variations in the absolute value of the threshold and hysteresis.

**CAUTION:** Shutdown mode is unconditional. That is, the fan will remain off as long as the  $V_{IN}$  pin is being held low or  $V_{IN} < V_{AS} + V_{HAS}$ .

## 4.0 SYSTEM BEHAVIOR

The flowcharts describing the TC646's behavioral algorithm are shown in Figure 4-1. They can be summarized as follows:

### 4.1 Power-Up

- (1) Assuming the device is not being held in auto-shutdown mode ( $V_{IN} > V_{AS}$ ).....
- (2) Turn  $V_{OUT}$  output on for 32 cycles of the PWM clock. This ensures that the fan will start from a dead stop.
- (3) During this Start-up Timer, if a fan pulse is detected, branch to Normal Operation; if none are received...
- (4) Activate the 32-cycle Start-up Timer one more time and look for fan pulse; if a fan pulse is detected, proceed to Normal Operation; if none are received...
- (5) Proceed to Fan Fault.
- (6) End.

### 4.2 Normal Operation

"Normal Operation" is an endless loop which may only be exited by entering shutdown mode, auto-shutdown mode or Fan Fault. The loop can be thought of as executing at the frequency of the oscillator and PWM.

- (1) Reset the missing pulse detector.
- (2) Is the TC646 in shutdown or auto-shutdown mode?  
If so...
  - a.  $V_{OUT}$  duty cycle goes to zero.
  - b.  $\overline{FAULT}$  is disabled.
  - c. Exit the loop and wait for  $V_{IN} > (V_{AS} + V_{HAS})$  to resume operation.
- (3) If an over-temperature fault occurs ( $V_{IN} > V_{OTF}$ ), activate  $FAULT$ ; release  $FAULT$  when  $V_{IN} < V_{OTF}$ .
- (4) Drive  $V_{OUT}$  to a duty cycle proportional to  $V_{IN}$  on a cycle by cycle basis.
- (5) If a fan pulse is detected, branch back to the start of the loop (1).
- (6) If the missing pulse detector times out ...
- (7) Activate the 3-cycle Diagnostic Timer and look for pulses; if a fan pulse is detected, branch back to the start of the loop (1); if none are received...
- (8) Activate the 32-cycle Start-up Timer and look for pulses; if a fan pulse is detected, branch back to the start of the loop (1); if none are received...
- (9) Quit Normal Operation and go to Fan Fault.
- (10) End.

### 4.3 Fan Fault

Fan fault is an infinite loop wherein the TC646 is latched in shutdown mode. This mode can only be released by a reset (i.e.,  $V_{IN}$  being brought below  $V_{SHDN}$ , then above  $(V_{AS} + V_{HAS})$ , or by power-cycling).

- (1) While in this state,  $\overline{FAULT}$  is latched on (low) and the  $V_{OUT}$  output is disabled.
- (2) A reset sequence applied to the  $V_{IN}$  pin will exit the loop to Power-up.
- (3) End.





**FIGURE 4-1:** TC646 Behavioral Algorithm Flowchart.

# TC646

## 5.0 TYPICAL APPLICATIONS

Designing with the TC646 involves the following:

- (1) The temperature sensor network must be configured to deliver 1.25V to 2.65V on  $V_{IN}$  for 0% to 100% of the temperature range to be regulated.
- (2) The auto-shutdown temperature must be set with a voltage divider on  $V_{AS}$ .
- (3) The output drive transistor and associated circuitry must be selected.
- (4) The SENSE network,  $R_{SENSE}$  and  $C_{SENSE}$ , must be designed for maximum efficiency while delivering adequate signal amplitude.
- (5) If shutdown capability is desired, the drive requirements of the external signal or circuit must be considered.

The TC642 demonstration and prototyping board (TC642DEMO) and the TC642 Evaluation Kit (TC642EV) provide working examples of TC646 circuits and prototyping aids. The TC642DEMO is a printed circuit board optimized for small size and ease of inclusion into system prototypes. The TC642EV is a larger board intended for benchtop development and analysis. At the very least, anyone contemplating a design using the TC646 should consult the documentation for both TC642EV (DS21403) and TC642DEMO (DS21401). Figure 5-1 shows the base schematic for the TC642DEMO.



**FIGURE 5-1:** Typical Application Circuit.

## 5.1 Temperature Sensor Design

The temperature signal connected to  $V_{IN}$  must output a voltage in the range of 1.25V to 2.65V (typical) for 0% to 100% of the temperature range of interest. The circuit in Figure 5-2 illustrates a convenient way to provide this signal.



**FIGURE 5-2:** Temperature Sensing Circuit.

Figure 5-2 shows a simple temperature dependent voltage divider circuit.  $RT_1$  is a conventional NTC thermistor, while  $R_1$  and  $R_2$  are standard resistors. The supply voltage,  $V_{DD}$ , is divided between  $R_2$  and the parallel combination of  $RT_1$  and  $R_1$ . For convenience, the parallel combination of  $RT_1$  and  $R_1$  will be referred to as  $R_{TEMP}$ . The resistance of the thermistor at various temperatures is obtained from the manufacturer's specifications. Thermistors are often referred to in terms of their resistance at 25°C.

Generally, the thermistor shown in Figure 5-2 is a non-linear device with a negative temperature coefficient (also called an NTC thermistor). In Figure 5-2,  $R_1$  is used to linearize the thermistor temperature response and  $R_2$  is used to produce a positive temperature coefficient at the  $V_{IN}$  node. As an added benefit, this configuration produces an output voltage delta of 1.4V, which is well within the range of the  $V_{C(SPAN)}$  specification of the TC646. A 100 kΩ NTC thermistor is selected for this application in order to keep  $I_{DIV}$  at a minimum.

For the voltage range at  $V_{IN}$  to be equal to 1.25V to 2.65V, the temperature range of this configuration is 0°C to 50°C. If a different temperature range is required from this circuit,  $R_1$  should be chosen to equal the resistance value of the thermistor at the center of this new temperature range. It is suggested that a maximum temperature range of 50°C be used with this circuit due to thermistor linearity limitations. With this change,  $R_2$  is adjusted according to the following equations:

### EQUATION

$$\frac{V_{DD} \times R_2}{R_{TEMP}(T_1) + R_2} = V(T_1)$$

$$\frac{V_{DD} \times R_2}{R_{TEMP}(T_2) + R_2} = V(T_2)$$

Where  $T_1$  and  $T_2$  are the chosen temperatures and  $R_{TEMP}$  is the parallel combination of the thermistor and  $R_1$ .

These two equations facilitate solving for the two unknown variables,  $R_1$  and  $R_2$ . More information about thermistors may be obtained from AN679, "Temperature Sensing Technologies", and AN685, "Thermistors In Single Supply Temperature Sensing Circuits", which can be downloaded from Microchip's web site at [www.microchip.com](http://www.microchip.com).

## 5.2 Auto-Shutdown Temperature Design

A voltage divider on  $V_{AS}$  sets the temperature where the part is automatically shut down if the sensed temperature at  $V_{IN}$  drops below the set temperature at  $V_{AS}$  (i.e.,  $V_{IN} < V_{AS}$ ). As with the  $V_{IN}$  input, 1.25V to 2.65V corresponds to the temperature range of interest from  $T_1$  to  $T_2$ , respectively. Assuming that the temperature sensor network designed above is linearly related to temperature, the shutdown temperature  $T_{AS}$  is related to  $T_2$  and  $T_1$  by:

### EQUATION

$$\frac{2.65V - 1.25V}{T_2 - T_1} = \frac{V_{AS} - 1.25V}{T_{AS} - T_1}$$

$$V_{AS} = \left( \frac{1.4V}{T_2 - T_1} \right) (T_{AS} - T_1) + 1.25V$$

For example, if 1.25V and 2.65V at  $V_{IN}$  corresponds to a temperature range of  $T_1 = 0^\circ\text{C}$  to  $T_2 = 125^\circ\text{C}$ , and the auto-shutdown temperature desired is 25°C, then  $V_{AS}$  voltage is:

### EQUATION

$$V_{AS} = \frac{1.4V}{(125 - 0)} (25 - 0) + 1.25V = 1.53V$$

The  $V_{AS}$  voltage may be set using a simple resistor divider as shown in Figure 5-3.



**FIGURE 5-3: V<sub>AS</sub> CIRCUIT**

Per Section 1.0, “Electrical Characteristics”, the leakage current at the V<sub>AS</sub> pin is no more than 1 μA. It is conservative to design for a divider current, I<sub>DIV</sub>, of 100 μA. If V<sub>DD</sub> = 5.0V then...

### EQUATION

$$I_{DIV} = 1e^{-4}A = \frac{5.0V}{R_1 + R_2}, \text{ therefore}$$

$$R_1 + R_2 = \frac{5.0V}{1e^{-4}A} = 50,000\Omega = 50k\Omega$$

We can further specify R<sub>1</sub> and R<sub>2</sub> by the condition that the divider voltage is equal to our desired V<sub>AS</sub>. This yields:

### EQUATION

$$V_{AS} = \frac{V_{DD} \times R_2}{R_1 + R_2}$$

Solving for the relationship between R<sub>1</sub> and R<sub>2</sub> results in:

### EQUATION

$$R_1 = R_2 \times \frac{V_{DD} - V_{AS}}{V_{AS}} = R_2 \times \frac{5 - 1.53}{1.53}$$

In the case of this example, R<sub>1</sub> = (2.27) R<sub>2</sub>. Substituting this relationship back into the original equation yields the resistor values:

$$R_2 = 15.3 \text{ k}\Omega, \text{ and}$$

$$R_1 = 34.7 \text{ k}\Omega$$

In this case, the standard values of 34.8 kΩ and 15.4 kΩ are very close to the calculated values and would be more than adequate.

## 5.3 Operations at Low Duty Cycle

One boundary condition which may impact the selection of the minimum fan speed is the irregular activation of the Diagnostic Timer due to the TC646 “missing” fan commutation pulses at low speeds. This is a natural consequence of low PWM duty cycles (typically 25% or less). Recall that the SENSE function detects commutation of the fan as disturbances in the current through R<sub>SENSE</sub>. These can only occur when the fan is energized (i.e., V<sub>OUT</sub> is “on”). At very low duty cycles, the V<sub>OUT</sub> output is “off” most of the time. The fan may be rotating normally, but the commutation events are occurring during the PWM’s off-time.

The phase relationship between the fan’s commutation and the PWM edges tends to “walk around” as the system operates. At certain points, the TC646 may fail to capture a pulse within the 32-cycle missing pulse detector window. If this happens, the 3-cycle Diagnostic Timer will be activated, the V<sub>OUT</sub> output will be active continuously for three cycles and, if the fan is operating normally, a pulse will be detected. If all is well, the system will return to normal operation. There is no harm in this behavior, but it may be audible to the user as the fan accelerates briefly when the Diagnostic Timer fires. For this reason, it is recommended that V<sub>AS</sub> be set no lower than 1.8V.

## 5.4 FanSense™ Network (R<sub>SENSE</sub> and C<sub>SENSE</sub>)

The FanSense network, comprised of R<sub>SENSE</sub> and C<sub>SENSE</sub>, allows the TC646 to detect commutation of the fan motor (FanSense™ technology). This network can be thought of as a differentiator and threshold detector. The function of R<sub>SENSE</sub> is to convert the fan current into a voltage. C<sub>SENSE</sub> serves to AC-couple this voltage signal and provide a ground-referenced input to the SENSE pin. Designing a proper SENSE network is simply a matter of scaling R<sub>SENSE</sub> to provide the necessary amount of gain (i.e., the current-to-voltage conversion ratio). A 0.1 μF ceramic capacitor is recommended for C<sub>SENSE</sub>. Smaller values require larger sense resistors, and higher value capacitors are bulkier and more expensive. Using a 0.1 μF capacitor results in reasonable values for R<sub>SENSE</sub>. Figure 5-4 illustrates a typical SENSE network. Figure 5-5 shows the waveforms observed using a typical SENSE network.

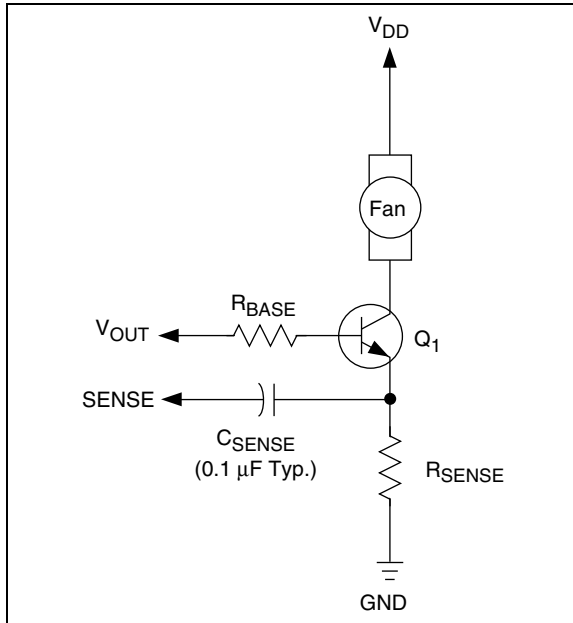

**FIGURE 5-4:** SENSE Network.

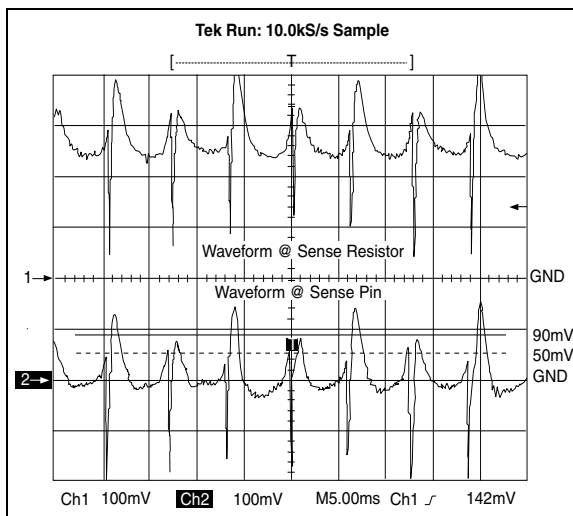

**FIGURE 5-5:** SENSE Waveforms.

Table 5-1 lists the recommended values of  $R_{SENSE}$  based on the nominal operating current of the fan. Note that the current draw specified by the fan manufacturer may be a worst-case rating for near-stall conditions and not the fan's nominal operating current. The values in Table 5-1 refer to actual average operating current. If the fan current falls between two of the values listed, use the higher resistor value. The end result of employing Table 5-1 is that the signal developed across the sense resistor is approximately 450 mV in amplitude.

**TABLE 5-1:**  $R_{SENSE}$  VS. FAN CURRENT

Nominal Fan Current (mA)	$R_{SENSE}$ ( $\Omega$ )
50	9.1
100	4.7
150	3.0
200	2.4
250	2.0
300	1.8
350	1.5
400	1.3
450	1.2
500	1.0

## 5.5 Output Drive Transistor Selection

The TC646 is designed to drive an external transistor or MOSFET for modulating power to the fan. This is shown as  $Q_1$  in Figures 5-1, 5-4, 5-6, 5-7, 5-8 and 5-9. The  $V_{OUT}$  pin has a minimum source current of 5 mA and a minimum sink current of 1 mA. Bipolar transistors or MOSFETs may be used as the power switching element, as shown in Figure 5-7. When high current gain is needed to drive larger fans, two transistors may be used in a Darlington configuration. These circuit topologies are shown in Figure 5-7: (a) shows a single NPN transistor used as the switching element; (b) illustrates the Darlington pair; and (c) shows an N-channel MOSFET.

One major advantage of the TC646's PWM control scheme versus linear speed control is that the power dissipation in the pass element is kept very low. Generally, low cost devices in very small packages, such as TO-92 or SOT, can be used effectively. For fans with nominal operating currents of no more than 200 mA, a single transistor usually suffices. Above 200 mA, the Darlington or MOSFET solution is recommended. For the fan sensing function to work correctly, it is imperative that the pass transistor be fully saturated when "on".

Table 5-2 gives examples of some commonly available transistors and MOSFETs. This table should be used as a guide only since there are many transistors and MOSFETs which will work just as well as those listed. The critical issues when choosing a device to use as  $Q_1$  are: (1) the breakdown voltage ( $V_{(BR)CEO}$  or  $V_{DS}$  (MOSFET)) must be large enough to withstand the highest voltage applied to the fan (**Note:** This will occur when the fan is off); (2) 5 mA of base drive current must be enough to saturate the transistor when conducting the full fan current (transistor must have sufficient gain); (3) the  $V_{OUT}$  voltage must be high enough to sufficiently drive the gate of the MOSFET to minimize the  $R_{DS(on)}$  of the device; (4) rated fan current draw must be within the transistor's/MOSFET's current handling capability; and (5) power dissipation must be kept within the limits of the chosen device.

# TC646

A base-current limiting resistor is required with bipolar transistors. This is shown in Figure 5-6.



**FIGURE 5-6:** Circuit For Determining  $R_{BASE}$ .

The correct value for this resistor can be determined as follows:

$$\begin{aligned} V_{OH} &= V_{RSENSE} + V_{BE(SAT)} + V_{RBASE} \\ V_{RSENSE} &= I_{FAN} \times R_{SENSE} \\ V_{RBASE} &= R_{BASE} \times I_{BASE} \\ I_{BASE} &= I_{FAN} / h_{FE} \end{aligned}$$

$V_{OH}$  is specified as 80% of  $V_{DD}$  in Section 1.0, "Electrical Characteristics";  $V_{BE(SAT)}$  is given in the chosen transistor data sheet. It is now possible to solve for  $R_{BASE}$ .

## EQUATION

$$R_{BASE} = \frac{V_{OH} - V_{BE(SAT)} - V_{RSENSE}}{I_{BASE}}$$

Some applications benefit from the fan being powered from a negative supply to keep motor noise out of the positive supply rails. This can be accomplished as shown in Figure 5-8. Zener diode  $D_1$  offsets the -12V power supply voltage, holding transistor  $Q_1$  off when  $V_{OUT}$  is low. When  $V_{OUT}$  is high, the voltage at the anode of  $D_1$  increases by  $V_{OUT}$ , causing  $Q_1$  to turn on. Operation is otherwise the same as in the case of fan operation from +12V.



**FIGURE 5-7:** Output Drive Transistor Circuit Topologies.



**FIGURE 5-8:** Power the Fan from a -12V Supply.

**TABLE 5-2: TRANSISTORS AND MOSFETS FOR Q<sub>1</sub> (V<sub>DD</sub> = 5V)**

Device	Package	Max. V <sub>BE(sat)</sub> /V <sub>GS</sub> (V)	Min. H <sub>FE</sub>	V <sub>CEO</sub> /V <sub>DS</sub> (V)	Fan Current (mA)	Suggested R <sub>BASE</sub> (Ω)
MMBT2222A	SOT-23	1.2	50	40	150	800
MPS2222A	TO-92	1.2	50	40	150	800
MPS6602	TO-92	1.2	50	40	500	301
SI2302	SOT-23	2.5	NA	20	500	<b>Note 1</b>
MGSF1N02E	SOT-23	2.5	NA	20	500	<b>Note 1</b>
SI4410	SO-8	4.5	NA	30	1000	<b>Note 1</b>
SI2308	SOT-23	4.5	NA	60	500	<b>Note 1</b>

**Note 1:** A series gate resistor may be used in order to control the MOSFET turn-on and turn-off times.

## 5.6 Latch-up Considerations

As with any CMOS IC, the potential exists for latch-up if signals are applied to the device which are outside the power supply range. This is of particular concern during power-up if the external circuitry (such as the sensor network, V<sub>AS</sub> divider or shutdown circuit) is powered by a supply different from that of the TC646. Care should be taken to ensure that the TC646's V<sub>DD</sub> supply powers up first. If possible, the networks attached to V<sub>IN</sub> and V<sub>AS</sub> should connect to the V<sub>DD</sub> supply at the same physical location as the IC itself. Even if the IC and any external networks are powered by the same supply, physical separation of the connecting points can result in enough parasitic capacitance and/or inductance in the power supply connections to delay one power supply "routing" versus another.

## 5.7 Power Supply Routing and Bypassing

Noise present on the V<sub>IN</sub> and V<sub>AS</sub> inputs may cause erroneous operation of the FAULT output. As a result, these inputs should be bypassed with a 0.01 μF capacitor mounted as close to the package as possible. This is especially true of V<sub>IN</sub>, which is usually driven from a high impedance source (such as a thermistor). In addition, the V<sub>DD</sub> input should be bypassed with a 1 μF capacitor. Grounds should be kept as short as possible. To keep fan noise off the TC646 ground pin, individual ground returns for the TC646 and the low side of the fan current sense resistor should be used.

# TC646

## Design Example

**Step 1.** Calculate  $R_1$  and  $R_2$  based on using an NTC having a resistance of  $10\text{ k}\Omega$  at  $T_{\text{MIN}}$  ( $25^\circ\text{C}$ ) and  $4.65\text{ k}\Omega$  at  $T_{\text{MAX}}$  ( $45^\circ\text{C}$ ) (See Figure 5-9).

$$R_1 = 20.5\text{ k}\Omega$$

$$R_2 = 3.83\text{ k}\Omega$$

**Step 2.** Set auto-shutdown level  $V_{\text{AS}} = 1.8\text{V}$ .

Limit the divider current to  $100\text{ }\mu\text{A}$  from which

$$R_5 = 33\text{ k}\Omega$$

$$R_6 = 18\text{ k}\Omega$$

**Step 3.** Design the output circuit.

Maximum fan motor current =  $250\text{ mA}$ .  $Q_1$

beta is chosen at 50 from which  $R_7 = 800\text{ }\Omega$ .



**FIGURE 5-9:** Design Example.

## 5.8 TC646 as a Microcontroller Peripheral

In a system containing a microcontroller or other host intelligence, the TC646 can be effectively managed as a CPU peripheral. Routine fan control functions can be performed by the TC646 without controller intervention. The microcontroller receives temperature data from one or more points throughout the system. It calculates a fan operating speed based on an algorithm specifically designed for the application at hand. The processor controls fan speed using complementary port bits I/O1 through I/O3. Resistors  $R_1$  through  $R_6$  (5% tolerance) form a crude 3-bit DAC that translates the 3-bit code from the processor's outputs into a 1.6V DC control signal. A monolithic DAC or digital pot may be used instead of the circuit shown in Figure 5-10.

With  $V_{\text{AS}}$  set at 1.8V, the TC646 enters auto-shutdown when the controller's output code is 000[B]. Output codes 001[B] to 111[B] operate the fan from roughly 40% to 100% of full speed. An open-drain output from the processor (I/O0) can be used to reset the TC646 following detection of a fault condition. The  $\overline{\text{FAULT}}$  output can be connected to the controller's interrupt input, or to another I/O pin, for polled operation.



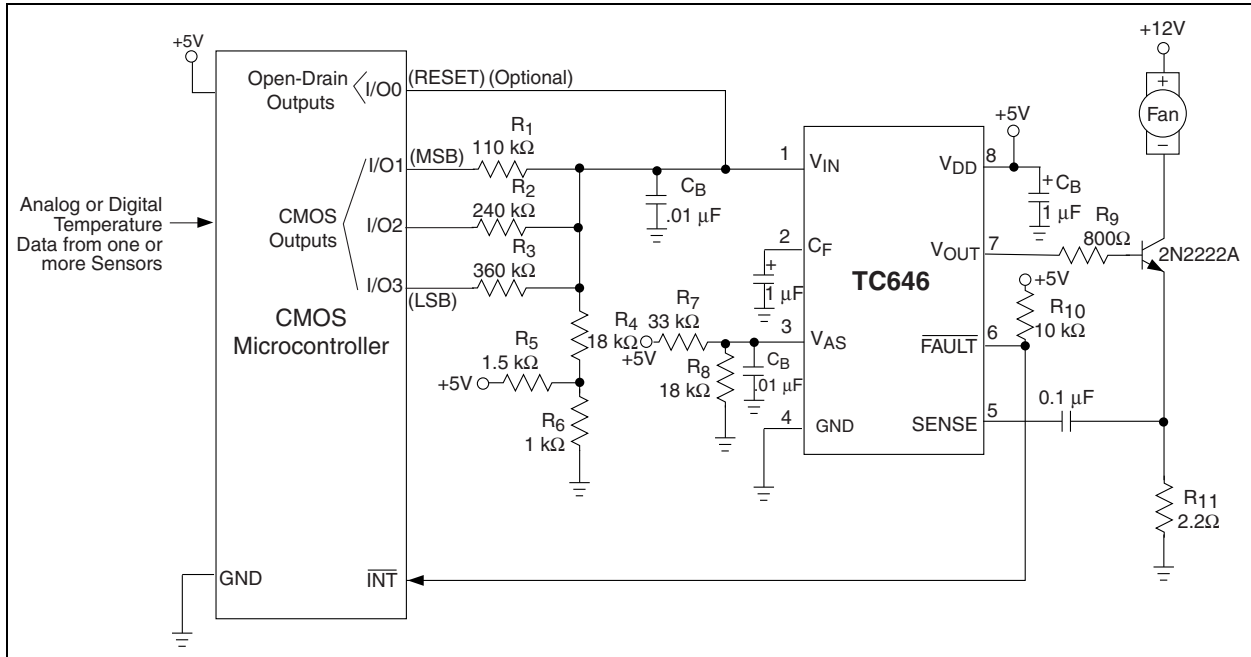

**FIGURE 5-10:** TC646 as a Microcontroller Peripheral.

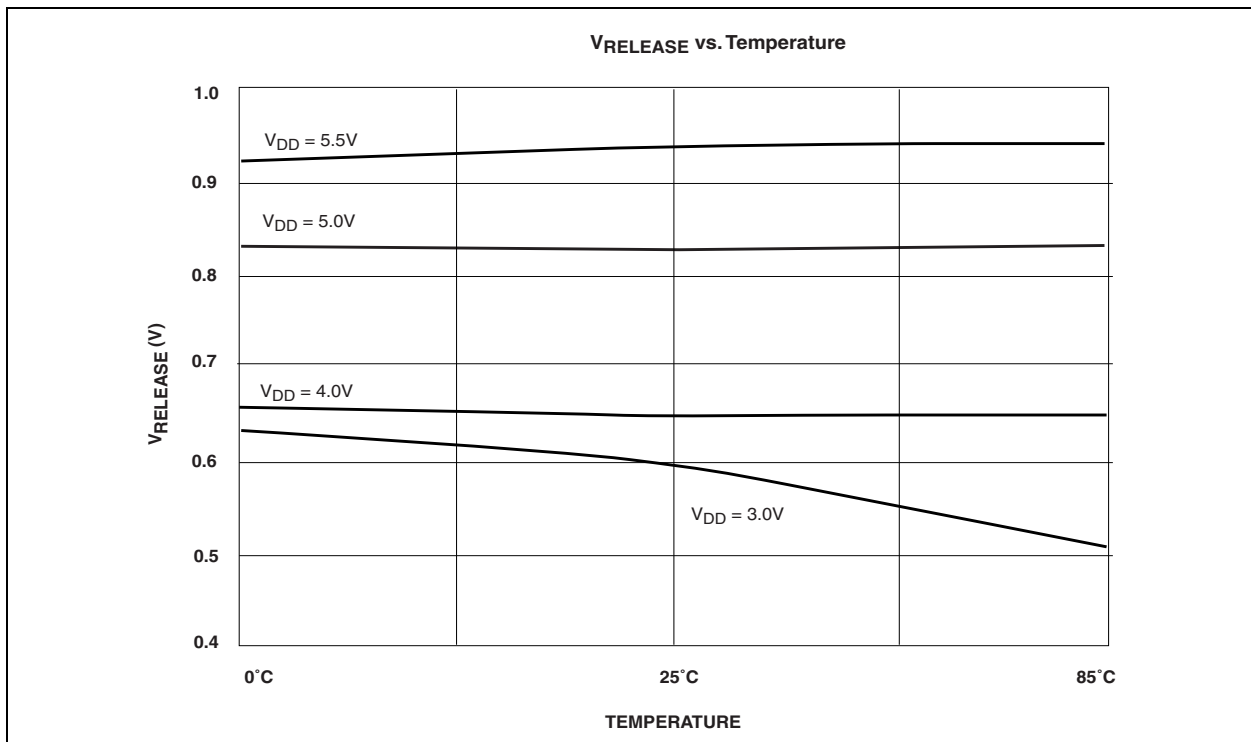

**FIGURE 5-11:**  $V_{RELEASE}$  vs. Temperature.

# TC646

## 6.0 PACKAGING INFORMATION

### 6.1 Package Marking Information

8-Lead PDIP (300 mil)

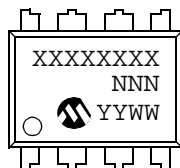

Example:

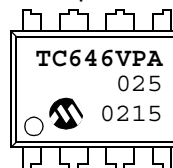

8-Lead SOIC (150 mil)

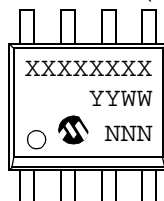

Example:

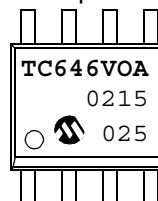

8-Lead MSOP

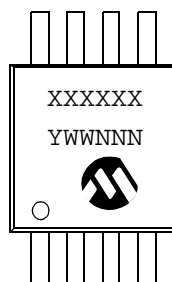

Example:

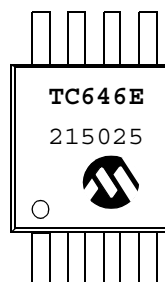

<b>Legend:</b>	XX...X	Customer-specific information
	Y	Year code (last digit of calendar year)
	YY	Year code (last 2 digits of calendar year)
	WW	Week code (week of January 1 is week '01')
	NNN	Alphanumeric traceability code
	(e3)	Pb-free JEDEC designator for Matte Tin (Sn)
	*	This package is Pb-free. The Pb-free JEDEC designator (e3) can be found on the outer packaging for this package.

**Note:** In the event the full Microchip part number cannot be marked on one line, it will be carried over to the next line, thus limiting the number of available characters for customer-specific information.

## 8-Lead Plastic Dual In-line (P) – 300 mil (PDIP)

**Note:** For the most current package drawings, please see the Microchip Packaging Specification located at <http://www.microchip.com/packaging>

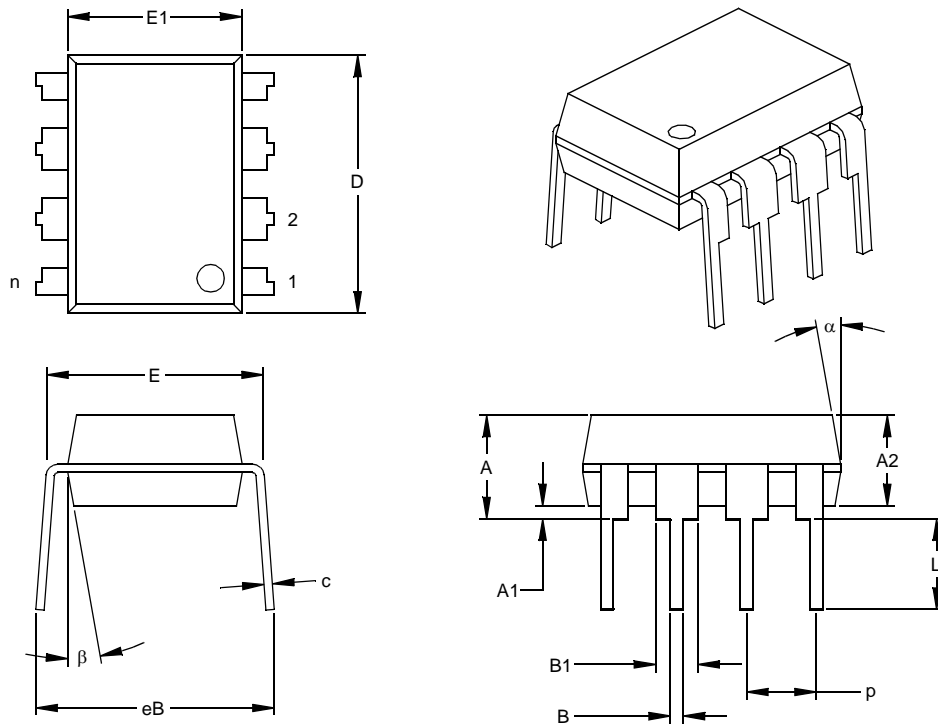

Dimension Limits	Units	INCHES*			MILLIMETERS		
		MIN	NOM	MAX	MIN	NOM	MAX
Number of Pins	n		8			8	
Pitch	P		.100			2.54	
Top to Seating Plane	A	.140	.155	.170	3.56	3.94	4.32
Molded Package Thickness	A2	.115	.130	.145	2.92	3.30	3.68
Base to Seating Plane	A1	.015			0.38		
Shoulder to Shoulder Width	E	.300	.313	.325	7.62	7.94	8.26
Molded Package Width	E1	.240	.250	.260	6.10	6.35	6.60
Overall Length	D	.360	.373	.385	9.14	9.46	9.78
Tip to Seating Plane	L	.125	.130	.135	3.18	3.30	3.43
Lead Thickness	c	.008	.012	.015	0.20	0.29	0.38
Upper Lead Width	B1	.045	.058	.070	1.14	1.46	1.78
Lower Lead Width	B	.014	.018	.022	0.36	0.46	0.56
Overall Row Spacing	§ eB	.310	.370	.430	7.87	9.40	10.92
Mold Draft Angle Top	α	5	10	15	5	10	15
Mold Draft Angle Bottom	β	5	10	15	5	10	15

\* Controlling Parameter  
 § Significant Characteristic

**Notes:**  
 Dimensions D and E1 do not include mold flash or protrusions. Mold flash or protrusions shall not exceed .010" (0.254mm) per side.  
 JEDEC Equivalent: MS-001  
 Drawing No. C04-018

# TC646

## 8-Lead Plastic Small Outline (SN) – Narrow, 150 mil (SOIC)

**Note:** For the most current package drawings, please see the Microchip Packaging Specification located at <http://www.microchip.com/packaging>



Dimension Limits	Units	INCHES*			MILLIMETERS		
		MIN	NOM	MAX	MIN	NOM	MAX
Number of Pins	n		8			8	
Pitch	p		.050			1.27	
Overall Height	A	.053	.061	.069	1.35	1.55	1.75
Molded Package Thickness	A2	.052	.056	.061	1.32	1.42	1.55
Standoff §	A1	.004	.007	.010	0.10	0.18	0.25
Overall Width	E	.228	.237	.244	5.79	6.02	6.20
Molded Package Width	E1	.146	.154	.157	3.71	3.91	3.99
Overall Length	D	.189	.193	.197	4.80	4.90	5.00
Chamfer Distance	h	.010	.015	.020	0.25	0.38	0.51
Foot Length	L	.019	.025	.030	0.48	0.62	0.76
Foot Angle	f	0	4	8	0	4	8
Lead Thickness	c	.008	.009	.010	0.20	0.23	0.25
Lead Width	B	.013	.017	.020	0.33	0.42	0.51
Mold Draft Angle Top	$\alpha$	0	12	15	0	12	15
Mold Draft Angle Bottom	$\beta$	0	12	15	0	12	15

\* Controlling Parameter  
 § Significant Characteristic

**Notes:**

Dimensions D and E1 do not include mold flash or protrusions. Mold flash or protrusions shall not exceed .010" (0.254mm) per side.  
 JEDEC Equivalent: MS-012  
 Drawing No. C04-057

## 8-Lead Plastic Micro Small Outline Package (MS) (MSOP)

**Note:** For the most current package drawings, please see the Microchip Packaging Specification located at <http://www.microchip.com/packaging>



Dimension Limits	Units	INCHES			MILLIMETERS*		
		MIN	NOM	MAX	MIN	NOM	MAX
Number of Pins	n		8				8
Pitch	P	.026			0.65		
Overall Height	A			.044			1.18
Molded Package Thickness	A2	.030	.034	.038	0.76	0.86	0.97
Standoff §	A1	.002		.006	0.05		0.15
Overall Width	E	.184	.193	.200	4.67	4.90	5.08
Molded Package Width	E1	.114	.118	.122	2.90	3.00	3.10
Overall Length	D	.114	.118	.122	2.90	3.00	3.10
Foot Length	L	.016	.022	.028	0.40	0.55	0.70
Footprint (Reference)	F	.035	.037	.039	0.90	0.95	1.00
Foot Angle	φ	0		6	0		6
Lead Thickness	c	.004	.006	.008	0.10	0.15	0.20
Lead Width	B	.010	.012	.016	0.25	0.30	0.40
Mold Draft Angle Top	α		7			7	
Mold Draft Angle Bottom	β		7			7	

\*Controlling Parameter

§ Significant Characteristic

Notes:

Dimensions D and E1 do not include mold flash or protrusions. Mold flash or protrusions shall not exceed .010" (0.254mm) per side.

Drawing No. C04-111

## 6.2 Taping Form

### Component Taping Orientation for 8-Pin MSOP Devices

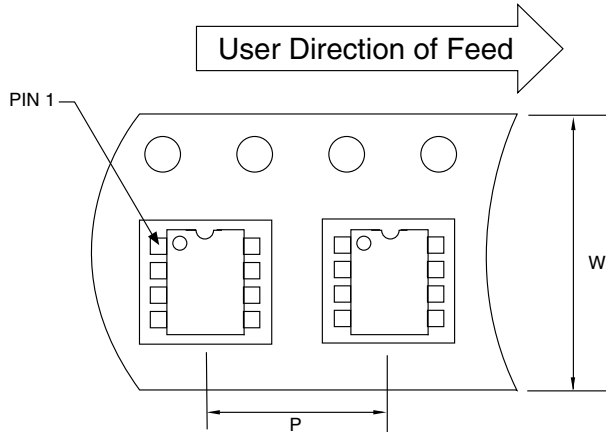

Standard Reel Component Orientation  
for 713 Suffix Device

#### Carrier Tape, Number of Components Per Reel and Reel Size

Package	Carrier Width (W)	Pitch (P)	Part Per Full Reel	Reel Size
8-Pin MSOP	12 mm	8 mm	2500	13 in

### Component Taping Orientation for 8-Pin SOIC (Narrow) Devices

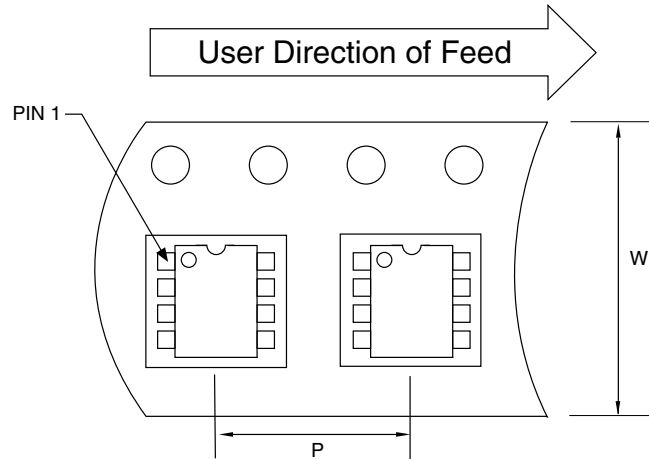

Standard Reel Component Orientation  
for 713 Suffix Device

#### Carrier Tape, Number of Components Per Reel and Reel Size

Package	Carrier Width (W)	Pitch (P)	Part Per Full Reel	Reel Size
8-Pin SOIC (N)	12 mm	8 mm	2500	13 in

## 7.0 REVISION HISTORY

### Revision D (December 2012)

Added a note to each package outline drawing.

# TC646

---

---

NOTES:



---

## THE MICROCHIP WEB SITE

Microchip provides online support via our WWW site at [www.microchip.com](http://www.microchip.com). This web site is used as a means to make files and information easily available to customers. Accessible by using your favorite Internet browser, the web site contains the following information:

- **Product Support** – Data sheets and errata, application notes and sample programs, design resources, user's guides and hardware support documents, latest software releases and archived software
- **General Technical Support** – Frequently Asked Questions (FAQ), technical support requests, online discussion groups, Microchip consultant program member listing
- **Business of Microchip** – Product selector and ordering guides, latest Microchip press releases, listing of seminars and events, listings of Microchip sales offices, distributors and factory representatives

## CUSTOMER CHANGE NOTIFICATION SERVICE

Microchip's customer notification service helps keep customers current on Microchip products. Subscribers will receive e-mail notification whenever there are changes, updates, revisions or errata related to a specified product family or development tool of interest.

To register, access the Microchip web site at [www.microchip.com](http://www.microchip.com). Under "Support", click on "Customer Change Notification" and follow the registration instructions.

## CUSTOMER SUPPORT

Users of Microchip products can receive assistance through several channels:

- Distributor or Representative
- Local Sales Office
- Field Application Engineer (FAE)
- Technical Support

Customers should contact their distributor, representative or field application engineer (FAE) for support. Local sales offices are also available to help customers. A listing of sales offices and locations is included in the back of this document.

**Technical support is available through the web site at: <http://microchip.com/support>**

---

---

## READER RESPONSE

It is our intention to provide you with the best documentation possible to ensure successful use of your Microchip product. If you wish to provide your comments on organization, clarity, subject matter, and ways in which our documentation can better serve you, please FAX your comments to the Technical Publications Manager at (480) 792-4150.

Please list the following information, and use this outline to provide us with your comments about this document.

TO: Technical Publications Manager Total Pages Sent \_\_\_\_\_

RE: Reader Response

From: Name \_\_\_\_\_

Company \_\_\_\_\_

Address \_\_\_\_\_

City / State / ZIP / Country \_\_\_\_\_

Telephone: (\_\_\_\_\_) \_\_\_\_\_ - \_\_\_\_\_ FAX: (\_\_\_\_\_) \_\_\_\_\_ - \_\_\_\_\_

Application (optional):

Would you like a reply?  Y  N

Device:

Literature Number: DS21446D

Questions:

1. What are the best features of this document?

---

---

2. How does this document meet your hardware and software development needs?

---

---

3. Do you find the organization of this document easy to follow? If not, why?

---

---

4. What additions to the document do you think would enhance the structure and subject?

---

---

5. What deletions from the document could be made without affecting the overall usefulness?

---

---

6. Is there any incorrect or misleading information (what and where)?

---

---

7. How would you improve this document?

---

---

## PRODUCT IDENTIFICATION SYSTEM

To order or obtain information, e.g., on pricing or delivery, refer to the factory or the listed sales office.

<u>PART NO.</u>	<u>X</u>	<u>/XX</u>
Device	Temperature Range	Package
Device: TC646: PWM Fan Speed Controller w/Auto Shutdown and Fault Detection  Temperature Range: V = 0°C to +85°C E = -40°C to +85°C  Package: PA = Plastic DIP (300 mil Body), 8-lead * OA = Plastic SOIC, (150 mil Body), 8-lead UA = Plastic Micro Small Outline (MSOP), 8-lead  * PDIP package is only offered in the V temp range		<b>Examples:</b>  a) TC646VOA: PWM Fan Speed Controller w/ Auto Shutdown and Fault Detection, SOIC package.  b) TC646VUA: PWM Fan Speed Controller w/ Auto Shutdown and Fault Detection, MSOP package.  c) TC646VPA: PWM Fan Speed Controller w/ Auto Shutdown and Fault Detection, PDIP package.  d) TC646EOA713: PWM Fan Speed Controller w/Auto Shutdown and Fault Detection, SOIC package, Tape and Reel.

## Sales and Support

### Data Sheets

Products supported by a preliminary Data Sheet may have an errata sheet describing minor operational differences and recommended workarounds. To determine if an errata sheet exists for a particular device, please contact one of the following:

1. Your local Microchip sales office
2. The Microchip Worldwide Site ([www.microchip.com](http://www.microchip.com))

Please specify which device, revision of silicon and Data Sheet (include Literature #) you are using.

### New Customer Notification System

Register on our web site ([www.microchip.com/cn](http://www.microchip.com/cn)) to receive the most current information on our products.

# TC646

---

NOTES:

---

---

**Note the following details of the code protection feature on Microchip devices:**

- Microchip products meet the specification contained in their particular Microchip Data Sheet.
- Microchip believes that its family of products is one of the most secure families of its kind on the market today, when used in the intended manner and under normal conditions.
- There are dishonest and possibly illegal methods used to breach the code protection feature. All of these methods, to our knowledge, require using the Microchip products in a manner outside the operating specifications contained in Microchip's Data Sheets. Most likely, the person doing so is engaged in theft of intellectual property.
- Microchip is willing to work with the customer who is concerned about the integrity of their code.
- Neither Microchip nor any other semiconductor manufacturer can guarantee the security of their code. Code protection does not mean that we are guaranteeing the product as “unbreakable.”

Code protection is constantly evolving. We at Microchip are committed to continuously improving the code protection features of our products. Attempts to break Microchip's code protection feature may be a violation of the Digital Millennium Copyright Act. If such acts allow unauthorized access to your software or other copyrighted work, you may have a right to sue for relief under that Act.

---

Information contained in this publication regarding device applications and the like is provided only for your convenience and may be superseded by updates. It is your responsibility to ensure that your application meets with your specifications. MICROCHIP MAKES NO REPRESENTATIONS OR WARRANTIES OF ANY KIND WHETHER EXPRESS OR IMPLIED, WRITTEN OR ORAL, STATUTORY OR OTHERWISE, RELATED TO THE INFORMATION, INCLUDING BUT NOT LIMITED TO ITS CONDITION, QUALITY, PERFORMANCE, MERCHANTABILITY OR FITNESS FOR PURPOSE. Microchip disclaims all liability arising from this information and its use. Use of Microchip devices in life support and/or safety applications is entirely at the buyer's risk, and the buyer agrees to defend, indemnify and hold harmless Microchip from any and all damages, claims, suits, or expenses resulting from such use. No licenses are conveyed, implicitly or otherwise, under any Microchip intellectual property rights.

#### **Trademarks**

The Microchip name and logo, the Microchip logo, dsPIC, FlashFlex, KEELOQ, KEELOQ logo, MPLAB, PIC, PICmicro, PICSTART, PIC<sup>32</sup> logo, rPIC, SST, SST Logo, SuperFlash and UNI/O are registered trademarks of Microchip Technology Incorporated in the U.S.A. and other countries.

FilterLab, Hampshire, HI-TECH C, Linear Active Thermistor, MTP, SEEVAL and The Embedded Control Solutions Company are registered trademarks of Microchip Technology Incorporated in the U.S.A.

Silicon Storage Technology is a registered trademark of Microchip Technology Inc. in other countries.

Analog-for-the-Digital Age, Application Maestro, BodyCom, chipKIT, chipKIT logo, CodeGuard, dsPICDEM, dsPICDEM.net, dsPICworks, dsSPEAK, ECAN, ECONOMONITOR, FanSense, HI-TIDE, In-Circuit Serial Programming, ICSP, Mindi, MiWi, MPASM, MPF, MPLAB Certified logo, MPLIB, MPLINK, mTouch, Omniclient Code Generation, PICC, PICC-18, PICDEM, PICDEM.net, PICkit, PICTail, REAL ICE, rLAB, Select Mode, SQI, Serial Quad I/O, Total Endurance, TSHARC, UniWinDriver, WiperLock, ZENA and Z-Scale are trademarks of Microchip Technology Incorporated in the U.S.A. and other countries.

SQTP is a service mark of Microchip Technology Incorporated in the U.S.A.

GestIC and ULPP are registered trademarks of Microchip Technology Germany II GmbH & Co. & KG, a subsidiary of Microchip Technology Inc., in other countries.

All other trademarks mentioned herein are property of their respective companies.

© 2002-2012, Microchip Technology Incorporated, Printed in the U.S.A., All Rights Reserved.

 Printed on recycled paper.

ISBN: 9781620768273

**QUALITY MANAGEMENT SYSTEM**  
**CERTIFIED BY DNV**  
**== ISO/TS 16949 ==**

*Microchip received ISO/TS-16949:2009 certification for its worldwide headquarters, design and wafer fabrication facilities in Chandler and Tempe, Arizona; Gresham, Oregon and design centers in California and India. The Company's quality system processes and procedures are for its PIC<sup>®</sup> MCUs and dsPIC<sup>®</sup> DSCs, KEELOQ<sup>®</sup> code hopping devices, Serial EEPROMs, microperipherals, nonvolatile memory and analog products. In addition, Microchip's quality system for the design and manufacture of development systems is ISO 9001:2000 certified.*



# MICROCHIP

## Worldwide Sales and Service

### AMERICAS

**Corporate Office**  
2355 West Chandler Blvd.  
Chandler, AZ 85224-6199  
Tel: 480-792-7200  
Fax: 480-792-7277  
Technical Support:  
<http://www.microchip.com/support>  
Web Address:  
[www.microchip.com](http://www.microchip.com)

**Atlanta**  
Duluth, GA  
Tel: 678-957-9614  
Fax: 678-957-1455

**Boston**  
Westborough, MA  
Tel: 774-760-0087  
Fax: 774-760-0088

**Chicago**  
Itasca, IL  
Tel: 630-285-0071  
Fax: 630-285-0075

**Cleveland**  
Independence, OH  
Tel: 216-447-0464  
Fax: 216-447-0643

**Dallas**  
Addison, TX  
Tel: 972-818-7423  
Fax: 972-818-2924

**Detroit**  
Farmington Hills, MI  
Tel: 248-538-2250  
Fax: 248-538-2260

**Indianapolis**  
Noblesville, IN  
Tel: 317-773-8323  
Fax: 317-773-5453

**Los Angeles**  
Mission Viejo, CA  
Tel: 949-462-9523  
Fax: 949-462-9608

**Santa Clara**  
Santa Clara, CA  
Tel: 408-961-6444  
Fax: 408-961-6445

**Toronto**  
Mississauga, Ontario,  
Canada  
Tel: 905-673-0699  
Fax: 905-673-6509

### ASIA/PACIFIC

**Asia Pacific Office**  
Suites 3707-14, 37th Floor  
Tower 6, The Gateway  
Harbour City, Kowloon  
Hong Kong  
Tel: 852-2401-1200  
Fax: 852-2401-3431

**Australia - Sydney**  
Tel: 61-2-9868-6733  
Fax: 61-2-9868-6755

**China - Beijing**  
Tel: 86-10-8569-7000  
Fax: 86-10-8528-2104

**China - Chengdu**  
Tel: 86-28-8665-5511  
Fax: 86-28-8665-7889

**China - Chongqing**  
Tel: 86-23-8980-9588  
Fax: 86-23-8980-9500

**China - Hangzhou**  
Tel: 86-571-2819-3187  
Fax: 86-571-2819-3189

**China - Hong Kong SAR**  
Tel: 852-2943-5100  
Fax: 852-2401-3431

**China - Nanjing**  
Tel: 86-25-8473-2460  
Fax: 86-25-8473-2470

**China - Qingdao**  
Tel: 86-532-8502-7355  
Fax: 86-532-8502-7205

**China - Shanghai**  
Tel: 86-21-5407-5533  
Fax: 86-21-5407-5066

**China - Shenyang**  
Tel: 86-24-2334-2829  
Fax: 86-24-2334-2393

**China - Shenzhen**  
Tel: 86-755-8864-2200  
Fax: 86-755-8203-1760

**China - Wuhan**  
Tel: 86-27-5980-5300  
Fax: 86-27-5980-5118

**China - Xian**  
Tel: 86-29-8833-7252  
Fax: 86-29-8833-7256

**China - Xiamen**  
Tel: 86-592-2388138  
Fax: 86-592-2388130

**China - Zhuhai**  
Tel: 86-756-3210040  
Fax: 86-756-3210049

### ASIA/PACIFIC

**India - Bangalore**  
Tel: 91-80-3090-4444  
Fax: 91-80-3090-4123

**India - New Delhi**  
Tel: 91-11-4160-8631  
Fax: 91-11-4160-8632

**India - Pune**  
Tel: 91-20-2566-1512  
Fax: 91-20-2566-1513

**Japan - Osaka**  
Tel: 81-6-6152-7160  
Fax: 81-6-6152-9310

**Japan - Tokyo**  
Tel: 81-3-6880-3770  
Fax: 81-3-6880-3771

**Korea - Daegu**  
Tel: 82-53-744-4301  
Fax: 82-53-744-4302

**Korea - Seoul**  
Tel: 82-2-554-7200  
Fax: 82-2-558-5932 or  
82-2-558-5934

**Malaysia - Kuala Lumpur**  
Tel: 60-3-6201-9857  
Fax: 60-3-6201-9859

**Malaysia - Penang**  
Tel: 60-4-227-8870  
Fax: 60-4-227-4068

**Philippines - Manila**  
Tel: 63-2-634-9065  
Fax: 63-2-634-9069

**Singapore**  
Tel: 65-6334-8870  
Fax: 65-6334-8850

**Taiwan - Hsin Chu**  
Tel: 886-3-5778-366  
Fax: 886-3-5770-955

**Taiwan - Kaohsiung**  
Tel: 886-7-213-7828  
Fax: 886-7-330-9305

**Taiwan - Taipei**  
Tel: 886-2-2508-8600  
Fax: 886-2-2508-0102

**Thailand - Bangkok**  
Tel: 66-2-694-1351  
Fax: 66-2-694-1350

### EUROPE

**Austria - Wels**  
Tel: 43-7242-2244-39  
Fax: 43-7242-2244-393

**Denmark - Copenhagen**  
Tel: 45-4450-2828  
Fax: 45-4485-2829

**France - Paris**  
Tel: 33-1-69-53-63-20  
Fax: 33-1-69-30-90-79

**Germany - Munich**  
Tel: 49-89-627-144-0  
Fax: 49-89-627-144-44

**Italy - Milan**  
Tel: 39-0331-742611  
Fax: 39-0331-466781

**Netherlands - Drunen**  
Tel: 31-416-690399  
Fax: 31-416-690340

**Spain - Madrid**  
Tel: 34-91-708-08-90  
Fax: 34-91-708-08-91

**UK - Wokingham**  
Tel: 44-118-921-5869  
Fax: 44-118-921-5820

11/29/12



## Стандарт Электрон Связь

Мы молодая и активно развивающаяся компания в области поставок электронных компонентов. Мы поставляем электронные компоненты отечественного и импортного производства напрямую от производителей и с крупнейших складов мира.

Благодаря сотрудничеству с мировыми поставщиками мы осуществляем комплексные и плановые поставки широчайшего спектра электронных компонентов.

Собственная эффективная логистика и склад в обеспечивает надежную поставку продукции в точно указанные сроки по всей России.

Мы осуществляем техническую поддержку нашим клиентам и предпродажную проверку качества продукции. На все поставляемые продукты мы предоставляем гарантию .

Осуществляем поставки продукции под контролем ВП МО РФ на предприятия военно-промышленного комплекса России , а также работаем в рамках 275 ФЗ с открытием отдельных счетов в уполномоченном банке. Система менеджмента качества компании соответствует требованиям ГОСТ ISO 9001.

Минимальные сроки поставки, гибкие цены, неограниченный ассортимент и индивидуальный подход к клиентам являются основой для выстраивания долгосрочного и эффективного сотрудничества с предприятиями радиоэлектронной промышленности, предприятиями ВПК и научно-исследовательскими институтами России.

С нами вы становитесь еще успешнее!

### Наши контакты:

**Телефон:** +7 812 627 14 35

**Электронная почта:** [sales@st-electron.ru](mailto:sales@st-electron.ru)

**Адрес:** 198099, Санкт-Петербург,  
Промышленная ул, дом № 19, литера Н,  
помещение 100-Н Офис 331