

EMI Filtered Connectors

from performance to board space, to cost, we offer many reasons and options for managing EMI @ the signal & power I/O



Series F Ferrite Filtered Connectors offer a low cost, space saving solution for high frequency interference... **FC3-FC7**

Series 500 Low-Profile Feed-Through Connectors deliver reliable EMI filtering in 90° PCB and straight PCB connectors... **FC8-FC11**

Series 600 Hi-Density Filtered Connectors meet the growing need for increased circuit densities in smaller packages... **FC12-FC13**

Series 700 High Performance Connectors feature feed-through capacitive and PI filters for the most effective filtering... **FC16-FC37**

Filtered Combo D-Sub Connectors use tubular capacitors for high insertion loss in signal, power and coaxial contacts... **FC38-FC48**

Micro D Series Connectors allow designers to incorporate EMI filtering into even smaller packages... **FC49-FC53**

Datacom Connectors including modular jack, miniature ribbon and mini-DIN protect critical datacom lines... **FC54-FC58**

USB Connectors incorporate EMI filtering and ESD protection into standard USB packages freeing up valuable board space... **FC59**

Hooded Strain Reliefs for shock protection from exposed wires and short circuits... **FC60**

Performance Specifications & Board/Panel Cutouts... **FC62-FC64**



Advantages of a Filtered Connector

- **Low ground impedance** – Full ground plate and metallic shell provide minimal impedance and superior performance compared to on-board filter with high impedance
- **Eliminate re-radiation** – Filtered connector at interface leaves no path for bypassing the filter
- **Ground plane shielding** – API's filtered connector ground planes shield the box even at the connector port
- **Efficient space utilization** – Filters located in the connectors provide additional space on PCB board
- **Consistent performance** – Filtered connectors provide more consistent pin to pin performance
- **Fewer components** – Filtered connectors reduce component count creating cost savings
- **Reliability** – API tests 100% of filters, on-board filters are usually spot tested

Advantages of API Filtered Connectors

API Technologies' Spectrum Control brand offers the industry's most complete line of filtered D-subminiature connectors. Our connectors are available in shell sizes from 9 to 50, and come in many termination types, such as PC mount, wire wrap, solder cup and 90° PCB. In addition, API offers a wide range of filtering options, allowing you to find the right balance between performance and economy.

EMI filter options include our Pi filter configuration, which provides 45-60 dB per decade slope to insertion loss curve, our capacitive-only C filters that provide cost-effective EMI attenuation, ferrite filtered series F connectors (designed for filtering in situations that do not tolerate capacitive loading of circuit), as well as our series 500 connectors, with small .318" footprints.

The construction of our high performance Series 600 and 700 connectors features a one-piece zinc diecast shell, which is subsequently nickel-plated. Each filter is constructed with 360° grounding with ground plate, and our patented coaxial springs ensure ground continuity. And with API's advanced in-house ceramic tube design, you'll get a reliable, high performance filter from start to finish.

Advantages of an API Filtered Connector

- **Low ground impedance** – Full ground plate and metallic shell provide minimal impedance and superior performance compared to on-board filter with high impedance
- **Eliminate re-radiation** – Filtered connector at interface leaves no path for bypassing the filter
- **Ground plane shielding** – API filtered connector ground planes shield the box even at the connector port
- **Efficient space utilization** – Filters located in connector provides additional space on PCB board
- **Consistent performance** – Filtered connectors provide more consistent pin to pin performance
- **Fewer components** – Filtered connectors reduce component count creating cost savings
- **Reliability** – API tests 100% of filters, on-board filters are usually spot tested



Series F Ferrite Filtered Connectors

The Series F filtered D-subminiature connectors incorporate a solid slab of ferrite material as the filtering element. This rugged one-piece design provides a com-compact connector that is a drop-in replacement for standard connectors. The ferrite material has been chosen for optimum filtering performance in the 10 to 300 MHz range.

Series F Applications

- Personal computers, microcomputer-applied products and peripheral/terminal equipment
- Eliminates common-mode noise along data lines in data communication terminals and digital equipment

Features

- Low cost, high performance ferrite filter
- No distortion of wave forms
- Replaces individual ferrite bead filters, saving cost and space
- Provides both pin to ground and pin to pin filtering
- Effective in helping meet requirements of FCC, VDE, EN55022 and Japan's VCCI
- Short, space saving .318" footprint
- Interchangeable with standard D-subminiature connectors
- Can be installed directly over PCB trace pattern with no shorting
- 4-40 UNC locking insert eliminates loose hardware
- Metal shielding front shell
- Gold plated contacts
- RoHS compliant versions available (replace 56- with 56F)



Mechanical Specifications

Front Shell Steel (Tin plated)
Housing UL 94V-0 Rated thermoplastic, black
Contacts Phosphor bronze (sockets) or brass (pins)
Contact Plating Gold Flash (<10µ in.) over nickel
Operating Temperature -40°C to +105°C

Electrical Specifications

Frequency (MHz)	Impedance (Ohms)	
	Right Angle	Vertical
1	2	1
10	15	6
30	20	10
50	23	12
100	27	15

Frequency Range 10 – 300 MHz
Current Rating 5 Amps
Dielectric Withstand Voltage . . 1000 VAC for one minute
Insulation Resistance 1000 megohms Min. @ 500VDC

Series F Ferrite Filtered Connectors

Pin Contact – Right Angle Mount



Part Number	Description	Typ. Impedance (Ohms)		Frequency Range	A +/-	B +/-	C +/-	D +/-	E +/-	F +/-	G +/-	H +/-	I +/-	J +/-
		30 MHz	100 MHz		0.010 (0.25)	0.005 (0.13)	0.015 (0.38)	0.010 (0.25)	0.015 (0.38)	0.005 (0.13)	0.004 (0.10)	0.005 (0.13)	0.005 (0.13)	0.005 (0.13)
€ 56-402-001	D-Sub 9 pin	20	27	10 MHz to 300 MHz	0.666 (16.92)	0.984 (25.00)	1.213 (30.81)	0.318 (8.08)	0.751 (19.10)	0.324 (8.22)	0.108 (2.74)	0.984 (25.00)	0.432 (10.98)	0.606 (15.40)
€ 56-412-001	D-Sub 15 pin				0.994 (25.25)	1.312 (33.32)	1.541 (39.14)	0.318 (8.08)	0.751 (19.10)	0.648 (16.46)	0.108 (2.74)	1.312 (33.32)	0.756 (19.20)	0.929 (23.60)
€ 56-422-001	D-Sub 25 pin				1.534 (38.96)	1.852 (47.04)	2.088 (53.04)	0.318 (8.08)	0.751 (19.10)	1.196 (30.36)	0.110 (2.76)	1.852 (47.04)	1.304 (31.12)	1.476 (37.50)

€ Also available through API's authorized European distributors/agents.

Dimensions in inches (mm)

Series F Ferrite Filtered Connectors

Socket Contact – Right Angle Mount



*High-Density



PC Board Mounting Dimensions



PC Board Mounting Dimensions

Part Number	Description	Typ. Impedance (Ohms)		Frequency Range	A +/-	B +/-	C +/-	D +/-	E +/-	F +/-	G +/-	H +/-	I +/-	J +/-
		30 MHz	100 MHz		0.010	0.005	0.015	0.010	0.015	0.005	0.004	0.005	0.005	0.005
€ 56-404-001	D-Sub 9 socket	20	27	10 MHz to 300 MHz	0.643 (16.33)	0.984 (25.00)	1.213 (30.81)	0.318 (8.08)	0.755 (19.20)	0.324 (8.22)	0.108 (2.74)	0.984 (25.00)	0.432 (10.98)	0.606 (15.40)
€ 56-414-001	D-Sub 15 socket				0.971 (24.66)	1.312 (33.32)	1.541 (39.14)	0.318 (8.08)	0.755 (19.20)	0.648 (16.46)	0.108 (2.74)	1.312 (33.32)	0.756 (19.20)	0.929 (23.60)
€ 56-424-001	D-Sub 25 socket				1.511 (38.38)	1.852 (47.04)	2.088 (53.04)	0.318 (8.08)	0.755 (19.20)	1.196 (30.36)	0.110 (2.76)	1.852 (47.04)	1.304 (31.12)	1.476 (37.50)
€ 56-414-001-HD	Hi-Density 15 socket	16	26		* See inset drawing									

€ Also available through API's authorized European distributors/agents.

Dimensions in inches (mm)

Series F Ferrite Filtered Connectors

Pin Contact – Vertical Mount



Part Number	Description	Typ. Impedance (Ohms)		Frequency Range	A +/-	B +/-	C +/-	D +/-	E +/-	F +/-	G +/-	H +/-	I +/-
		30 MHz	100 MHz		0.010 (0.25)	0.005 (0.13)	0.015 (0.38)	0.010 (0.25)	0.015 (0.38)	0.005 (0.13)	0.004 (0.10)	0.005 (0.13)	0.005 (0.13)
56-407-001	D-Sub 9 pin	10	15	10 MHz to 300 MHz	0.666 (16.92)	0.984 (25.00)	1.213 (30.81)	0.236 (5.99)	0.468 (11.88)	0.324 (8.22)	0.108 (2.74)	0.984 (25.00)	0.432 (10.98)
56-417-001	D-Sub 15 pin				.994 (25.25)	1.312 (33.32)	1.541 (39.14)	0.236 (5.99)	0.468 (11.88)	0.648 (16.46)	0.108 (2.74)	1.312 (33.32)	0.756 (19.20)
56-427-001	D-Sub 25 pin				1.534 (38.96)	1.852 (47.04)	2.088 (53.04)	0.236 (5.99)	0.468 (11.88)	1.196 (30.36)	0.110 (2.76)	1.852 (47.04)	1.304 (31.12)

Dimensions in inches (mm)

Series F Ferrite Filtered Connectors

Socket Contact – Vertical Mount



Part Number	Description	Typ. Impedance (Ohms)		Frequency Range	A +/-	B +/-	C +/-	D +/-	E +/-	F +/-	G +/-	H +/-	I +/-
		30 MHz	100 MHz		0.010 (0.25)	0.005 (0.13)	0.015 (0.38)	0.010 (0.25)	0.015 (0.38)	0.005 (0.13)	0.004 (0.10)	0.005 (0.13)	0.005 (0.13)
56-403-001	D-Sub 9 socket	10	15	10 MHz to 300 MHz	0.643 (16.33)	0.984 (25.00)	1.213 (30.81)	0.236 (5.99)	0.472 (11.98)	0.324 (8.22)	0.108 (2.74)	0.984 (25.00)	0.432 (10.98)
56-413-001	D-Sub 15 socket				.971 (24.66)	1.312 (33.32)	1.541 (39.14)	0.236 (5.99)	0.472 (11.98)	0.648 (16.46)	0.108 (2.74)	1.312 (33.32)	0.756 (19.20)
56-423-001	D-Sub 25 socket				1.511 (38.38)	1.852 (47.04)	2.088 (53.04)	0.236 (5.99)	0.472 (11.98)	1.196 (30.36)	0.110 (2.76)	1.852 (47.04)	1.304 (31.12)

Dimensions in inches (mm)

Series 500 Low Profile Filtered Connectors

API's Spectrum Control brand of Series 500 are cost effective, highly reliable EMI filtered D-subminiature connectors that feature a .318" footprint for 90 degree PCB connectors and a low profile housing for straight PCB connectors. Series 500 filtered D-sub are "drop-in" replacements for standard unfiltered D-sub connectors.

The ability of these connectors to achieve EMI filtering within the smaller footprint is the result of technical advances in ceramic capacitors. Series 500 connectors use tubular capacitors for high performance EMI filtering. Quality features for these connectors include board lock mounting, metal front shells and gold plated contacts.

Series 500 capacitive filtered D-sub connectors are an ideal solution to FCC/EC/VCCI emissions problems. These connectors are designed to protect equipment from external EMI noise and eliminate system glitches.

Series 500 Applications

- Personal computers
- Industrial process equipment
- Graphics workstations
- PBX telecommunications equipment
- Cellular base stations and medical electronics



Features

- "Drop-in" replacements for unfiltered D-subminiatures
- Compact design, featuring .318" footprint
- Tubular feed-through capacitors provide filtering superior to on-board components
- Ground plane design provides EMI shielding
- Full interchangeability; based on MIL-C-24308
- Each connector position is tested 100% for critical electrical parameters to ensure consistent performance
- Insulators are UL recognized UL94-V0 flammability rated
- 9, 15 and 25 shell sizes
- Available with board lock feature and 4-40 mounting threads
- Selective filtering available
- UL/CSA approved
- Greater than 40 dB filtering up through 1 GHz without resonances
- Bi-directional control of EMI at the I/O ports

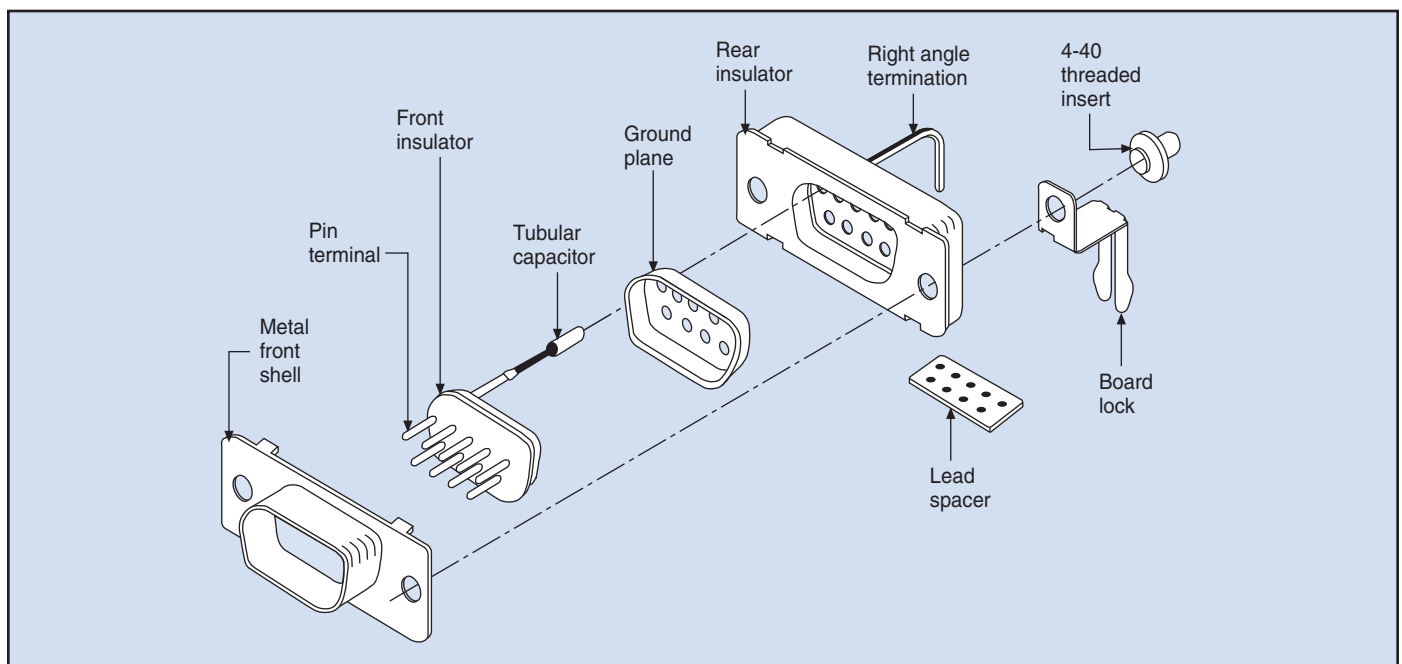

Series 500 Low Profile Filtered Connectors



Mechanical Specifications

- Shell Steel, tin plated
- Insulators Glass-filled polyester, flammability UL94V-O
- Pin Contacts Copper alloy CA725, 15 microinch (0.38 μm) gold plated* over nickel
- Socket Contacts Copper alloy CA725, 30 microinch (0.76 μm) gold plated* over nickel
- *Heavier gold plating available upon request.
- Ground Plane Phosphor bronze, nickel plated
- Operating Temperature -40°C to +125°C
- Capacitors Proprietary barium titanate ceramic formulations

Other environmental tests such as shock, vibration, humidity, etc. are performed as detailed in our filtered connector performance specifications on page FC81.

Electrical Specifications

- Current Rating 5 Amps
- RF Current Rating 0.3 Amps
- Contact Resistance 10 milliohms maximum
- Capacitance 120, 440, 840, 1000, 1500 pF $\pm 30\%$
- Working Voltage 100 VDC
- Dielectric Withstanding Voltage 300 VDC
- Insulation Resistance 1 Gohm minimum
- UL Recognized Under category of communication circuit accessories, File #E149046



840 pF is typically within 2 dB of 1000 pF curve.

Filter Performance

Cap. (pF) Value $\pm 30\%$	3 dB Cut-off Freq. (MHz)	Insertion Loss (dB)					
		20 MHz	100 MHz	500 MHz	1 GHz	2 GHz	5 GHz
120	40	–	4	21	26	26	20
440	11	3	15	27	33	32	25
840	6	6	19	32	38	37	25
1000	3	8	21	35	41	38	25
1500	2	10	25	40	47	42	25

Insertion loss measured per MIL-STD-220, no load, 50 ohm source and load. Above data represents guaranteed minimum.

Series 500 Low Profile Filtered Connectors

Pin Contact (*plug*) Straight PC Mount



90° PC Mount



Size	A	B	C	D	E
9	1.213 (30.81)	0.984 (24.99)	0.666 (16.92)	0.540 (13.72)	0.748 (19.00)
15	1.541 (39.14)	1.312 (33.32)	0.994 (25.25)	0.867 (22.02)	1.076 (27.33)
25	2.088 (53.04)	1.852 (47.04)	1.534 (38.96)	1.412 (35.86)	1.616 (41.05)

Standard Tolerance = ±.015 (0.38)

Dimensions in inches (mm)

Socket Contact (*receptacle*) Straight PC Mount



90° PC Mount



Size	A	B	C	D	E
9	1.213 (30.81)	0.984 (24.99)	0.642 (16.31)	0.540 (13.72)	0.748 (19.00)
15	1.541 (39.14)	1.312 (33.32)	0.970 (24.64)	0.867 (22.02)	1.076 (27.33)
25	2.088 (53.04)	1.852 (47.04)	1.510 (38.35)	1.412 (35.86)	1.616 (41.05)

Standard Tolerance = ±.015 (0.38)

Dimensions in inches (mm)

Series 500 Low Profile Filtered Connectors

Ordering Information

Example: **56-524-013-GBL**



This part number represents a Series 500 filtered D-sub connector with 25 contacts, socket to 90° PCB mount configuration. The filter has a capacitance value of 1000 pF and the connector includes a grounded board lock.

For special needs or combinations of features, contact API engineering.

Capacitance Value
010 - 120 pF
011 - 440 pF
012 - 840 pF
013 - 1000 pF
014 - 1500 pF

Mounting or Hardware Options

TI - 4-40 threads on mounting flange (.120" (3.05mm) hole if not selected)
GBL - Grounded board lock, includes 4-40 threads (available only on 90° PCB)
GBLF - Grounded board lock and ferrite slab, provides the enhanced performance of an (LC) filter (available only on 90° PCB)

GBL Option

Features

- Snap-in retention to PC board, requires no hardware
- Ensures low ground impedance for superior filtering
- 4-40 threads on mounting flange eliminate loose hardware

Dimensions in inches (mm)

Board Layout

Typical Layout for .318" (8.08) Footprint		Shell Size	A	B	C	D
	9	.984 (24.99)	.436 = 4 x .109 (11.07 = 4 x 2.77)	.327 = 3 x .109 (8.31 = 3 x 2.77)	.492 (12.50)	
	15	1.312 (33.32)	.763 = 7 x .109 (19.38 = 7 x 2.77)	.654 = 6 x .109 (16.61 = 6 x 2.77)	.656 (16.66)	
	25	1.852 (47.04)	1.308 = 12 x .109 (33.22 = 12 x 2.77)	1.199 = 11 x .109 (30.45 = 11 x 2.77)	.926 (23.52)	

Dimensions in inches (mm)

Series 600 High-Density Filtered Connectors

The miniaturization of electronic systems and sub-systems is pushing designers to increase circuit densities within smaller packages. To address this growing need, API Technologies' Spectrum Control brand has developed a line of filtered High-Density D-subminiature connectors. This new line of connectors incorporates the high performance and reliable filtering of API's standard D-sub in the High-Density format.

Features

- Connectors designed to MIL-C-24308
- Capacitance values from 85 pF to 4000 pF
- Filter type feed-through C
- Selectively specify and filter each contact position
- Available in feed-through capacitive configurations

Mechanical Specifications:

Same as Series 700 connectors, page FC21.

Typical Insertion Loss



Above curves represent application of proper grounding fundamentals, for assistance consult with Spectrum Control.

Insertion loss measured per MIL-STD-220, no load, 50 ohm source and load.

Electrical Specifications

Current Rating 3 Amps

RF Current Rating . . 0.3 Amps

Contact Resistance . . 15 milliohms maximum

UL Recognized Under category of communication circuit accessories, File #E149046

Electrical Specifications: High-Density Connectors

Filter Designations	Filter Circuits	Capacitance		3 dB Cut-off Frequency Max. (MHz)	Dielectric With-standing Voltage	Working Voltage DC -55°C to +125°C	Minimum Insertion Loss - Decibels (dB)									
		Value	Tol.				5 MHz	10 MHz	20 MHz	50 MHz	100 MHz	200 MHz	500 MHz	1 GHz	2 GHz	5 GHz
15	C	85 pF	±25%	60	300V	100V	—	—	—	—	1	6	16	21	22	20
16		180 pF	±25%	28	300V	100V	—	—	—	1	8	10	18	25	26	24
18		1000 pF	±25%	5.1	300V	100V	—	3	8	14	20	25	32	35	41	39
19		4000 pF	±25%	1.3	300V	100V	8	13	19	26	31	37	45	48	52	47

Filter designation "G" for grounded contacts, "I" for insulated (not filtered) contacts. Filter designation "O" for omitted contact and no hole in ground plane.

Above data represents guaranteed minimum.

Ordering Information

Example: 56-605-015-LI

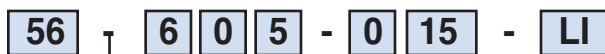

D-Sub Connector
Hi-Density

Shell Size**

- 0 = 15
- 1 = 26
- 2 = 44
- 3 = 62
- 4 = 78

- Standard connector
F - RoHS compliant version

Contact/Termination

- 1 - Pin to solder cup
- 2 - Pin to 90° PCB mount*
- 3 - Socket to PCB mount
- 4 - Socket to 90° PCB* mount
- 5 - Pin-socket adapter
- 7 - Pin to PCB mount

Special

- 0 = All positions same
- 9 = Special loading

** Some shell sizes require minimum order quantity. Consult API for details.

Filter Designation

- 15 - 85 pF FT
- 16 - 180 pF FT
- 18 - 1,000 pF FT
- 19 - 4,000 pF FT
- 20 - Insulated contact

Options

- LI = 4-40 inserts
- S = Solder dip tails
- 50G = μ gold
- GBL = Grounding board lock

* Required on right angle parts

This part number represents a Series 600 Hi-Density filtered D-Sub connector with 15 contacts, pin-socket adapter configuration. The FT filters have a capacitance value of 85 pF and the connector includes 4-40 locking inserts.

Note: VGA adapters also available. Consult factory

Series 600 High-Density Filtered Connectors

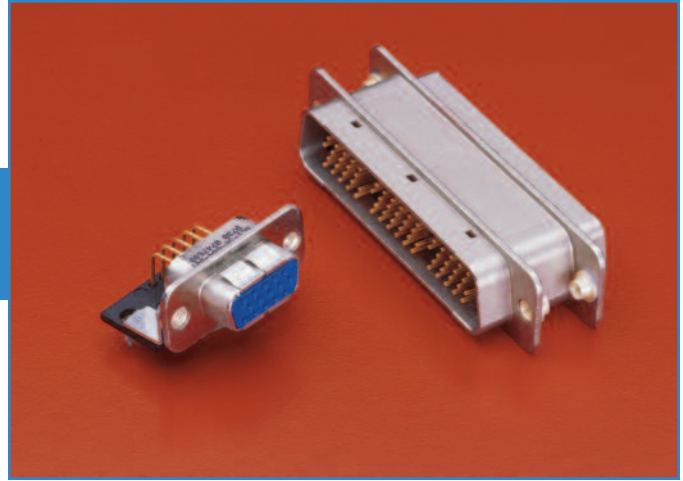

Pin/Socket Adapter

Size	A	B	C	D	E	F	G
15	1.213 (30.81)	.984 (24.99)	.640 (16.26)	.304 (7.72)	.505 (12.83)	.666 (16.92)	.333 (8.46)
26	1.541 (39.14)	1.312 (33.32)	.968 (24.59)	.304 (7.72)	.505 (12.83)	.994 (25.25)	.333 (8.46)
44	2.088 (53.04)	1.852 (47.04)	1.508 (38.30)	.304 (7.72)	.505 (12.83)	1.534 (38.96)	.333 (8.46)
62	2.729 (69.32)	2.500 (63.50)	2.156 (54.76)	.304 (7.72)	.505 (12.83)	2.182 (55.42)	.333 (8.46)
78	2.635 (66.93)	2.406 (61.11)	2.062 (52.37)	.416 (10.57)	.615 (15.62)	2.079 (52.81)	.420 (11.18)



Pin or Socket to Solder Cup, PCB Mount and 90° PCB Mount

Size	A	B	C	D	E	F	G
15	1.213 (30.81)	.984 (24.99)	.505 (12.83)	.666 (16.92)	.333 (8.46)	.757 (19.23)	.420 (10.67)
26	1.541 (39.14)	1.312 (33.32)	.505 (12.83)	.994 (25.25)	.333 (8.46)	1.085 (27.56)	.420 (10.67)
44	2.088 (53.04)	1.852 (47.04)	.505 (12.83)	1.534 (38.96)	.333 (8.46)	1.625 (41.28)	.420 (10.67)
62	2.729 (69.32)	2.500 (63.50)	.505 (12.83)	2.182 (55.42)	.333 (8.46)	2.273 (57.73)	.420 (10.67)
78	2.635 (66.93)	2.406 (61.11)	.615 (15.62)	2.079 (52.81)	.440 (11.18)	2.170 (55.12)	.527 (13.39)



Dimensions in inches (mm)

High-Density Filtered Adapter for Telecommunications



Within the telecommunications industry, it has been standard practice to use an adapter (male/female) type of EMI filtered system connector as the interface between the switching system electronics and the premise wiring. These filtered adapters provide effective containment of EMI compared to either D-subminiature or 50-position “ribbon” contact type connectors.

The following several factors have mandated the development of a new generation of filtered adapters.

Special Requirements

- Higher density wiring
- The need for more contacts, usually a multiple of 16
- Higher reliability contact geometries
- Bellcore TR-NWT-001089 requirements
 - 1000 volts AC withstand for one minute
 - 2500 volts spike surge testing
- Improved flammable resistant plastic insulators

API’s Spectrum Control brand, in response to these unique requirements of the telecommunication industry, has developed a new high-density filtered adapter.

Features

- New ceramic technology and filter element construction to accept higher voltages
- Improved reliability compared to “ribbon” type connectors
- Integral ground plane and one-piece diecast housing for the highest level of EMI integrity
- More contacts/wires per square inch of panel space through high-density arrangements
- 64 contact positions standard, with 78 positions available by request in any filter combination

Mechanical Specifications

- Shell* Zinc or aluminum diecast, nickel plated 150 μ inches (3.81 μ m) min.
- Insulators* Thermoplastic, UL94V-0
- Contacts* One-piece, screw machined Copper alloy, contact area plated 50 μ inches (1.27 μ m) gold over 50 μ inches (1.27 μ m) nickel
- Ground Plane* Brass, solder plated
- Grounding Springs* Beryllium copper, tin plated per MIL-T-10727
- Operating Temperature* -55°C to +125°C
- Capacitor* High performance ceramic feed-through utilizing ultra low ESR design

Electrical Specifications

- Rated Voltage* 100 VDC
- Current Rating* 3 Amps
- DC Resistance* 15 milliohm max.
- Dielectric Withstanding Voltage* 1000 VRMS (FCC Part 68 test)
- Capacitance* 1000 pF, \pm 25%
- Voltage Surge* meets 2500 volts surge (10/1000) (See Wave form figure on next page)

High-Density Filtered Adapter for Telecommunications

Filter Performance

Minimum Insertion Loss	
20 MHz	7 dB
50 MHz	14 dB
100 MHz	20 dB
500 MHz	32 dB
1 GHz	35 dB
2 GHz	41 dB
5 GHz	39 dB

Insertion loss measured per MIL-STD-220, no load, 50 ohm source and load. Above data represents guaranteed minimum.

Part Number for Ordering: #56-645-002



Dimensions in inches (mm)

Typical Insertion Loss



Above curves represent application of proper grounding fundamentals, for assistance consult with API.

Pulse Wave Form* (10 x 1000)



* Reference Bellcore TR-NWT-1089, V_{pp} = 1000V

Series 700 High Performance Filtered Connectors

Filter Selection

API's Spectrum Control brand of Series 700 connectors offer the highest performance filtering for all types of professional applications.

Features

- Available in 9, 15, 25, 37 and 50 shell sizes
- Variety of termination configurations including right angle and straight PCB for both pin and socket contact and as an adapter
- Capacitive and Pi type filters in a full range of capacitance values

The catalog data for this series is presented in order of shell size, and grouped by pin and socket contacts. Part numbers must be selected from the tables within the series section.

Typical Insertion Loss



Above curves represent application of proper grounding fundamentals, for assistance consult with API.

Insertion loss measured per MIL-STD-220, no load, 50ohm source and load.

Electrical Specifications: High Performance Connectors

Filter Designations	Filter Circuits	Capacitance		3 dB Cut-off Frequency Max. (MHz)	Dielectric With-standing Voltage	Working Voltage DC -55°C to +125°C	Minimum Insertion Loss - Decibels (dB)									
		Value	Tol.				5 MHz	10 MHz	20 MHz	50 MHz	100 MHz	200 MHz	500 MHz	1 GHz	2 GHz	5 GHz
J	Pi	100 pF	+100 -0%	32	300V	100V	—	—	—	2	6	11	27	40	43	40
A		310 pF	±20%	17	300V	100V	—	—	3	7	13	21	36	43	50	45
C		1000 pF	+150 -0%	3.2	300V	100V	—	5	9	19	30	43	62	70	68	63
K		2500 pF	+100 -0%	1.3	150V	50V	8	13	18	33	45	58	73	78	70	65
E		4000 pF	+100 -0%	0.8	150V	50V	8	13	20	35	48	61	76	80	70	65
N	C	375 pF	±20%	14	600V	200V	—	—	2	7	13	20	29	35	30	29
L		500 pF	±20%	10.6	600V	200V	—	—	3	10	15	22	31	37	33	31
F		830 pF	±20%	6.4	600V	200V	—	4	9	16	22	28	35	39	38	36
B		1000 pF	+100 -0%	3.2	600V	200V	—	5	10	17	23	30	37	43	44	42
D		5000 pF	+100 -0%	0.64	300V	100V	10	16	22	30	35	41	50	52	52	50

Filter designation "G" for grounded contacts, "I" for insulated (not filtered) contacts. Filter designation "O" for omitted contact and no hole in ground plane.

Above data represents guaranteed minimum.

Series 700 Specifications and Connector Ordering

Mechanical Specifications

- Shell* Zinc or aluminum diecast, nickel plated
 150 μ inches (3.81 μ m) min.
- Insulators* Glass-filled polyester,
 flammability UL94V-0
- Pin Contacts* Copper alloy, 15 μ inches
 (0.38 μ m) gold plated * over nickel
- Socket Contacts* Copper alloy, 30 μ inches
 (0.76 μ m) gold plated * over nickel
 * Heavier gold plating available upon request.
 See pg. FC43: Connector Options
- Terminations* Gold flash for PCB mount and solder
 cups. Solder dipped also available.
- Ground Plane* Brass, solder plated
- Grounding
 Springs* Beryllium copper, tin plated per
 MIL-T-10727
- Operating
 Temperature* -55°C to +125°C
- Capacitors* Proprietary barium titanate
 ceramic formulations

Electrical Specifications

- Current Rating* 5 Amps
 - R.F. Current
 Rating* 0.3 Amps
 - Contact
 Resistance* 10 milliohms maximum
 - UL Recognized* Under category of communication
 circuit accessories, File #E149046
 - Inductance on
 PI Filters* ~ 860 nH between 100 kHz and 1 MHz
- Solder cups accept up to a 20 gauge wire.

Note:
 For additional mechanical, electrical, and
 environmental specifications, refer to page FC79.

Ordering Your Connector

STEP 1: SELECTING THE FILTER

- Using the insert loss graphs on page FC20 determine which filters provide the required attenuation at the troublesome frequency, while not affecting the signal frequency by more than 3 to 6 dB.
- Choose the filter type, either feed-through capacitor or Pi. The Pi is generally considered better due to its superior high frequency performance and steeper curve. The feed-through capacitor is lower cost.
- Select capacitance value.
- Note the Spectrum letter designation for the filter chosen from the table on page FC20.

STEP 2: SELECTING THE CONNECTOR

- Turn to the appropriate size section.
 (9, 15, 25, 37, 50)
- Choose either pin contacts (plug) or socket contacts (receptacle).
- Choose the required termination type.
- From the table on the appropriate connector page, using the filter letter designation chosen in step 1 above, select the part number.

STEP 3: SPECIFYING OPTIONS

- Refer to page FC43 for special options including heavy gold plating, 4-40 mounting threads, grounding brackets, hardware, and others.
- Most options are available within the standard lead times.
- Some options require a part number suffix, while other combinations may require factory assistance for part number assignment. If a suffix is shown, add it to your selected part number. If more than one option is needed, consult with factory for part number assignment.

9 Series 700
Shell Size Pin Contact



Printed Circuit Board Mount

Spectrum Part Number	EMI Filter	
	Filter Designation**	Cap. Value
56-701-001	A	310 pF Pi
56-701-002	B	1000 pF C
56-701-003	C	1000 pF Pi
56-701-004	D	5000 pF C
56-701-005	E	4000 pF Pi
56-701-028	F	830 pF C
56-701-029	J	100 pF Pi
56-701-030	K	2500 pF Pi
56-701-047	N	375 pF C
56-701-086	L	500 pF C

Mating Face
 .666 (16.92) x 1.213 (30.81) x .494 (12.55)
 .984 (24.99) x .329 (8.36)

Termination Face
 .120 ± .005 DIA. HOLES (3.05 ± 0.13 DIA. HOLES)
 .757 (19.23) x .420 (10.67) x 10°

Side View
 .050 (1.27) x .238 (6.05) x .150 (3.81) ± .025 SQ. (.64 SQ.)
 .408 (10.36) ± .020 (51 ± .13)

Printed Circuit Board Right Angle Mount

Spectrum Part Number	EMI Filter	
	Filter Designation**	Cap. Value
* 56-702-001	A	310 pF Pi
56-702-002	B	1000 pF C
* 56-702-003	C	1000 pF Pi
56-702-004	D	5000 pF C
* 56-702-005	E	4000 pF Pi
56-702-007	F	830 pF C
56-702-008	J	100 pF Pi
56-702-009	K	2500 pF Pi
56-702-013	N	375 pF C
* 56-702-033	L	500 pF C

Mating Face
 .666 (16.92) x 1.213 (30.81) x .494 (12.55)
 .984 (24.99) x .329 (8.36)

Termination Face
 .120 ± .005 DIA. HOLES (3.05 ± 0.13 DIA. HOLES)
 .757 (19.23) x .420 (10.67) x 10°

Bottom View
 .125 ± .005 DIA. HOLES (3.18 ± .13 DIA. HOLES)
 .12R (3.05R) x .618 (15.70) x .540 (13.72) ± .275 (6.99) x .740 (18.80) ± .290 (7.37)

Side View
 .105 (2.67) ± .025 SQ. (.64 SQ.) x .590 (14.99) ± .702 (17.83)

* May be available from distributor stock.
 ** See page FC20 for filter performance.
 Standard Tolerance = ±.005 except where noted, ± = ±.015

Dimensions in inches (mm)

9 Series 700 Shell Size Pin Contact



Solderless Wire Wrap

Spectrum Part Number <i>Select one</i>	EMI Filter				
	L .500	L .375	L .250	Filter Desig.**	Cap. Value
56-701 -006 -022 -017				A	310 pF Pi
56-701 -007 -023 -018				B	1000 pF C
56-701 -008 -024 -019				C	1000 pF Pi
56-701 -009 -025 -020				D	5000 pF C
56-701 -010 -026 -021				E	4000 pF Pi
56-701 -037 -034 -031				F	830 pF C
56-701 -038 -035 -032				J	100 pF Pi
56-701 -039 -036 -033				K	2500 pF Pi
56-701 -050 -049 -048				N	375 pF C

Solder Cup Termination

Spectrum Part Number	EMI Filter	
	Filter Designation**	Cap. Value
* 56-701-011	A	310 pF Pi
* 56-701-012	B	1000 pF C
* 56-701-013	C	1000 pF Pi
* 56-701-014	D	5000 pF C
* 56-701-015	E	4000 pF Pi
* 56-701-040	F	830 pF C
56-701-041	J	100 pF Pi
56-701-042	K	2500 pF Pi
56-701-081	N	375 pF C
56-701-087	L	500 pF C

* May be available from distributor stock.
 ** See page FC20 for filter performance.
 Standard Tolerance = ±.005 except where noted, ∅ = ±.015

Dimensions in inches (mm)

9 Series 700 Shell Size Socket Contact



Printed Circuit Board Mount

Spectrum Part Number	EMI Filter	
	Filter Designation**	Cap. Value
56-703-001	A	310 pF Pi
56-703-002	B	1000 pF C
56-703-003	C	1000 pF Pi
56-703-004	D	5000 pF C
56-703-005	E	4000 pF Pi
56-703-022	F	830 pF C
56-703-023	J	100 pF Pi
56-703-024	K	2500 pF Pi
56-703-036	N	375 pF C
56-703-047	L	500 pF C

Printed Circuit Board Right Angle Mount

Spectrum Part Number	EMI Filter	
	Filter Designation**	Cap. Value
56-704-001	A	310 pF Pi
56-704-002	B	1000 pF C
* 56-704-003	C	1000 pF Pi
56-704-004	D	5000 pF C
* 56-704-005	E	4000 pF Pi
56-704-007	F	830 pF C
56-704-008	J	100 pF Pi
56-704-009	K	2500 pF Pi
56-704-018	N	375 pF C
56-704-035	L	500 pF C

* May be available from distributor stock.

** See page FC20 for filter performance.

Standard Tolerance = ±.005 except where noted, ∅ = ±.015

Dimensions in inches (mm)

9 Series 700 Shell Size Socket Contact & Pin/Socket Adapter



Solderless Wire Wrap

Spectrum Part Number <i>Select one</i>	EMI Filter				
	L .500	L .375	L .250	Filter Desig.**	Cap. Value
56-703 -006	-016	-011		A	310 pF Pi
56-703 -007	-017	-012		B	1000 pF C
56-703 -008	-018	-013		C	1000 pF Pi
56-703 -009	-019	-014		D	5000 pF C
* 56-703 -010	-020	* -015		E	4000 pF Pi
56-703 -031	-028	-025		F	830 pF C
56-703 -032	-029	-026		J	100 pF Pi
56-703 -033	-030	-027		K	2500 pF Pi
56-703 -039	-038	-037		N	375 pF C



Solder Cup Termination

Spectrum Part Number	EMI Filter	
	Filter Designation**	Cap. Value
* 56-706-001	A	310 pF Pi
56-706-002	B	1000 pF C
* 56-706-003	C	1000 pF Pi
56-706-004	D	5000 pF C
* 56-706-005	E	4000 pF Pi
56-706-006	F	830 pF C
56-706-007	J	100 pF Pi
* 56-706-008	K	2500 pF Pi
56-706-009	N	375 pF C
56-706-017	L	500 pF C



Pin/Socket Adapter

Spectrum Part Number	EMI Filter	
	Filter Designation**	Cap. Value
* 56-705-001	A	310 pF Pi
56-705-002	B	1000 pF C
* 56-705-003 €	C	1000 pF Pi
56-705-004	D	5000 pF C
* 56-705-005 €	E	4000 pF Pi
* 56-705-008	F	830 pF C
56-705-009	J	100 pF Pi
56-705-010	K	2500 pF Pi
56-705-026	N	375 pF C
56-705-049	L	500 pF C



€ Also available through API's authorized European distributors/agents.

* May be available from distributor stock.

** See page FC20 for filter performance.

Standard Tolerance = ±.005 except where noted, φ = ±.015

15 Series 700 Shell Size Pin Contact



Printed Circuit Board Mount

Spectrum Part Number	EMI Filter	
	Filter Designation**	Cap. Value
56-711-001	A	310 pF Pi
56-711-002	B	1000 pF C
56-711-003	C	1000 pF Pi
56-711-004	D	5000 pF C
56-711-005	E	4000 pF Pi
56-711-028	F	830 pF C
56-711-029	J	100 pF Pi
56-711-030	K	2500 pF Pi
56-711-048	N	375 pF C
56-711-088	L	500 pF C

Mating Face

Side View

Termination Face

Printed Circuit Board Right Angle Mount

Spectrum Part Number	EMI Filter	
	Filter Designation**	Cap. Value
* 56-712-001	A	310 pF Pi
56-712-002	B	1000 pF C
* 56-712-003	C	1000 pF Pi
56-712-004	D	5000 pF C
* 56-712-005	E	4000 pF Pi
* 56-712-007	F	830 pF C
56-712-008	J	100 pF Pi
56-712-009	K	2500 pF Pi
56-712-017	N	375 pF C
56-712-039	L	500 pF C

Mating Face

Termination Face

Bottom View

Side View

* May be available from distributor stock.
 ** See page FC20 for filter performance.
 Standard Tolerance = ±.005 except where noted, ∅ = ±.015

Dimensions in inches (mm)

15 Series 700 Shell Size Pin Contact



Solderless Wire Wrap

Spectrum Part Number <i>Select one</i>	EMI Filter			Filter Desig.**	Cap. Value
	L .500	L .375	L .250		
56-711 -006 -023 -018				A	310 pF Pi
56-711 -007 -024 -019				B	1000 pF C
56-711 -008 -025 -020				C	1000 pF Pi
56-711 -009 -026 -021				D	5000 pF C
56-711 -010 -027 -022				E	4000 pF Pi
56-711 -037 -034 -031				F	830 pF C
56-711 -038 -035 -032				J	100 pF Pi
56-711 -039 -036 -033				K	2500 pF Pi
56-711 -051 -050 -049				N	375 pF C



Solder Cup Termination

Spectrum Part Number	EMI Filter	
	Filter Designation**	Cap. Value
* 56-711-011	A	310 pF Pi
56-711-012	B	1000 pF C
* 56-711-013	C	1000 pF Pi
56-711-014	D	5000 pF C
* 56-711-015	E	4000 pF Pi
* 56-711-040	F	830 pF C
56-711-041	J	100 pF Pi
56-711-042	K	2500 pF Pi
56-711-085	N	375 pF C
56-711-086	L	500 pF C



* May be available from distributor stock.
 ** See page FC20 for filter performance.
 Standard Tolerance = ±.005 except where noted, ∅ = ±.015

Dimensions in inches (mm)

15 Series 700 Shell Size Socket Contact



Printed Circuit Board Mount

Spectrum Part Number	EMI Filter	
	Filter Designation**	Cap. Value
56-713-001	A	310 pF Pi
56-713-002	B	1000 pF C
56-713-003	C	1000 pF Pi
56-713-004	D	5000 pF C
56-713-005	E	4000 pF Pi
56-713-021	F	830 pF C
56-713-022	J	100 pF Pi
56-713-023	K	2500 pF Pi
56-713-037	N	375 pF C
56-713-045	L	500 pF C

Printed Circuit Board Right Angle Mount

Spectrum Part Number	EMI Filter	
	Filter Designation**	Cap. Value
* 56-714-001	A	310 pF Pi
56-714-002	B	1000 pF C
* 56-714-003	C	1000 pF Pi
56-714-004	D	5000 pF C
* 56-714-005	E	4000 pF Pi
* 56-714-006	F	830 pF C
56-714-007	J	100 pF Pi
56-714-008	K	2500 pF Pi
56-714-017	N	375 pF C
56-714-031	L	500 pF C

* May be available from distributor stock.

** See page FC20 for filter performance.

Standard Tolerance = ±.005 except where noted, ∅ = ±.015

Dimensions in inches (mm)

15 Series 700 Shell Size Socket Contact & Pin/Socket Adapter



Solderless Wire Wrap

Spectrum Part Number <i>Select one</i>	EMI Filter			
	L .500	L .375	L .250	Filter Desig.** / Cap. Value
56-713 -006	-016	-011	A	310 pF Pi
56-713 -007	-017	-012	B	1000 pF C
56-713 -008	-018	-013	C	1000 pF Pi
56-713 -009	-019	-014	D	5000 pF C
56-713 -010	-020	-015	E	4000 pF Pi
56-713 -030	-027	-024	F	830 pF C
56-713 -031	-028	-025	J	100 pF Pi
56-713 -032	-029	-026	K	2500 pF Pi
56-713 -040	-039	-038	N	375 pF C



Solder Cup Termination

Spectrum Part Number	EMI Filter	
	Filter Designation**	Cap. Value
* 56-716-001	A	310 pF Pi
56-716-002	B	1000 pF C
* 56-716-003	C	1000 pF Pi
56-716-004	D	5000 pF C
* 56-716-005	E	4000 pF Pi
56-716-006	F	830 pF C
56-716-007	J	100 pF Pi
* 56-716-008	K	2500 pF Pi
56-716-009	N	375 pF C
56-716-013	L	500 pF C



Pin/Socket Adapter

Spectrum Part Number	EMI Filter	
	Filter Designation**	Cap. Value
* 56-715-001	A	310 pF Pi
56-715-002	B	1000 pF C
* 56-715-003 €	C	1000 pF Pi
56-715-004	D	5000 pF C
* 56-715-005 €	E	4000 pF Pi
56-715-007	F	830 pF C
56-715-008	J	100 pF Pi
56-715-009	K	2500 pF Pi
56-715-015	N	375 pF C
56-715-040	L	500 pF C



€ Also available through API's authorized European distributors/agents.

* May be available from distributor stock.

** See page FC20 for filter performance.

Standard Tolerance = ±.005 except where noted, $\phi = \pm .015$

API TECHNOLOGIES • 8061 Avonia Rd. • Fairview, PA 16415 • Ph: 814-474-1571 • Fax: 814-474-3110 • eis.apitech.com

API TECHNOLOGIES' SPECTRUM CONTROL GmbH • Hansastrasse 6 • 91126 Schwabach, Germany • Phone: (49)-9122-795-0 • Fax: (49)-9122-795-58

Dimensions in inches (mm)

25 Series 700 Shell Size Pin Contact



Printed Circuit Board Mount

Spectrum Part Number	EMI Filter	
	Filter Designation**	Cap. Value
56-721-001	A	310 pF Pi
56-721-002	B	1000 pF C
56-721-003	C	1000 pF Pi
56-721-004	D	5000 pF C
56-721-005	E	4000 pF Pi
56-721-033	F	830 pF C
56-721-034	J	100 pF Pi
56-721-035	K	2500 pF Pi
56-721-063	N	375 pF C
56-721-111	L	500 pF C

Mating Face

Termination Face

Side View

Printed Circuit Board Right Angle Mount

Spectrum Part Number	EMI Filter	
	Filter Designation**	Cap. Value
* 56-722-001	A	310 pF Pi
56-722-002	B	1000 pF C
* 56-722-003	C	1000 pF Pi
56-722-004	D	5000 pF C
* 56-722-005	E	4000 pF Pi
* 56-722-008	F	830 pF C
56-722-009	J	100 pF Pi
56-722-010	K	2500 pF Pi
56-722-027	N	375 pF C
56-722-060	L	500 pF C

Mating Face

Termination Face

Bottom View

Side View

* May be available from distributor stock.
 ** See page FC20 for filter performance.
 Standard Tolerance = ±.005 except where noted, ∅ = ±.015

Dimensions in inches (mm)

25 Series 700 Shell Size Pin Contact



Solderless Wire Wrap

Spectrum Part Number <i>Select one</i>	EMI Filter				
	L .500	L .375	L .250	Filter Desig.**	Cap. Value
56-721 -006 -028 -024				A	310 pF Pi
56-721 -007 -029 -025				B	1000 pF C
56-721 -008 -030 -026				C	1000 pF Pi
56-721 -009 -031 -022				D	5000 pF C
56-721 -010 -032 -027				E	4000 pF Pi
56-721 -042 -039 -036				F	830 pF C
56-721 -043 -040 -037				J	100 pF Pi
56-721 -044 -041 -038				K	2500 pF Pi
56-721 -066 -065 -064				N	375 pF C

Mating Face

Termination Face

Side View

Solder Cup Termination

Spectrum Part Number	EMI Filter	
	Filter Designation**	Cap. Value
* 56-721-011	A	310 pF Pi
* 56-721-012	B	1000 pF C
* 56-721-013	C	1000 pF Pi
56-721-014	D	5000 pF C
* 56-721-015	E	4000 pF Pi
* 56-721-045	F	830 pF C
56-721-046	J	100 pF Pi
56-721-047	K	2500 pF Pi
56-721-070	N	375 pF C
56-721-112	L	500 pF C

Mating Face

Termination Face

Side View

* May be available from distributor stock.
 ** See page FC20 for filter performance.
 Standard Tolerance = ±.005 except where noted, ∅ = ±.015

Dimensions in inches (mm)

25 Series 700 Shell Size Socket Contact



Printed Circuit Board Mount

Spectrum Part Number	EMI Filter	
	Filter Designation**	Cap. Value
56-723-001	A	310 pF Pi
56-723-002	B	1000 pF C
56-723-003	C	1000 pF Pi
56-723-004	D	5000 pF C
56-723-005	E	4000 pF Pi
56-723-023	F	830 pF C
56-723-024	J	100 pF Pi
56-723-025	K	2500 pF Pi
56-723-045	N	375 pF C
56-723-069	L	500 pF C

Printed Circuit Board Right Angle Mount

Spectrum Part Number	EMI Filter	
	Filter Designation**	Cap. Value
* 56-724-001	A	310 pF Pi
56-724-002	B	1000 pF C
* 56-724-003	C	1000 pF Pi
56-724-004	D	5000 pF C
* 56-724-005	E	4000 pF Pi
* 56-724-008	F	830 pF C
56-724-009	J	100 pF Pi
56-724-010	K	2500 pF Pi
56-724-021	N	375 pF C
56-724-046	L	500 pF C

* May be available from distributor stock.

** See page FC20 for filter performance.

Standard Tolerance = ± 0.005 except where noted, $\phi = \pm 0.015$

Dimensions in inches (mm)

25 Series 700 Shell Size Pin/Socket Adapter



Solderless Wire Wrap

Spectrum Part Number <i>Select one</i>	EMI Filter			Filter Desig.**	Cap. Value
	L .500	L .375	L .250		
* 56-723 -006	-017	* -012		A	310 pF Pi
56-723 -007	-018	-013		B	1000 pF C
* 56-723 -008	-019	* -014		C	1000 pF Pi
56-723 -009	-020	-015		D	5000 pF C
* 56-723 -010	-021	* -016		E	4000 pF Pi
* 56-723 -032	-029	* -026		F	830 pF C
56-723 -033	-030	-027		J	100 pF Pi
56-723 -034	-031	-028		K	2500 pF Pi
56-723 -048	-047	-046		N	375 pF C

Solder Cup Termination

Spectrum Part Number	EMI Filter	
	Filter Designation**	Cap. Value
* 56-726-001	A	310 pF Pi
56-726-002	B	1000 pF C
* 56-726-003	C	1000 pF Pi
56-726-004	D	5000 pF C
* 56-726-005	E	4000 pF Pi
56-726-006	F	830 pF C
56-726-007	J	100 pF Pi
* 56-726-008	K	2500 pF Pi
56-726-009	N	375 pF C
56-726-021	L	500 pF C

Pin/Socket Adapter

Spectrum Part Number	EMI Filter	
	Filter Designation**	Cap. Value
* 56-725-001	A	310 pF Pi
56-725-002	B	1000 pF C
* 56-725-003 €	C	1000 pF Pi
56-725-004	D	5000 pF C
* 56-725-005 €	E	4000 pF Pi
* 56-725-019	F	830 pF C
56-725-020	J	100 pF Pi
* 56-725-021	K	2500 pF Pi
56-725-064	N	375 pF C
56-725-073	L	500 pF C

€ Also available through API's authorized European distributors/agents.

* May be available from distributor stock.

** See page FC20 for filter performance.

Standard Tolerance = ±.005 except where noted, ∅ = ±.015

API TECHNOLOGIES • 8061 Avonia Rd. • Fairview, PA 16415 • Ph: 814-474-1571 • Fax: 814-474-3110 • eis.apitech.com

API TECHNOLOGIES' SPECTRUM CONTROL GmbH • Hansastrasse 6 • 91126 Schwabach, Germany • Phone: (49)-9122-795-0 • Fax: (49)-9122-795-58

Dimensions in inches (mm)

37 Series 700

Shell Size Pin Contact



Printed Circuit Board Mount

Spectrum Part Number	EMI Filter	
	Filter Designation**	Cap. Value
56-731-001	A	310 pF Pi
56-731-002	B	1000 pF C
56-731-003	C	1000 pF Pi
56-731-004	D	5000 pF C
56-731-005	E	4000 pF Pi
56-731-028	F	830 pF C
56-731-029	J	100 pF Pi
56-731-030	K	2500 pF Pi
56-731-048	N	375 pF C
56-731-076	L	500 pF C

Mating Face
 2.729 (69.32)
 2.182 (55.42)
 .494 (12.55)
 2.500 (63.50)
 .329 (8.36)
 37

Termination Face
 2.273 (57.73)
 10°
 .420 (10.67)
 .120 ± .005 DIA. HOLES (3.05 ± .13 DIA. HOLES)

Side View
 .050 (1.27)
 .238 (6.05)
 .025 SQ. (.64 SQ.)
 .150 (3.81) ∅
 .408 (10.36) ∅

Printed Circuit Board Right Angle Mount

Spectrum Part Number	EMI Filter	
	Filter Designation**	Cap. Value
56-732-001	A	310 pF Pi
56-732-002	B	1000 pF C
* 56-732-003	C	1000 pF Pi
56-732-004	D	5000 pF C
* 56-732-005	E	4000 pF Pi
56-732-006	F	830 pF C
56-732-007	J	100 pF Pi
56-732-008	K	2500 pF Pi
56-732-009	N	375 pF C
56-732-023	L	500 pF C

Mating Face
 2.729 (69.32)
 2.182 (55.42)
 .494 (12.55)
 2.500 (63.50)
 .329 (8.36)
 37

Termination Face
 120 ± .005 DIA. HOLES (3.05 ± .13 DIA. HOLES)
 2.273 (57.73)
 10°
 .420 (10.67)
 .020 ± .005 (51 ± 13)

Bottom View
 .125 ± .005 DIA. HOLES (3.18 ± .13 DIA. HOLES)
 .290 (7.37)
 .12R (3.05R)
 2.142 (54.41)
 .275 (6.99)
 .740 (18.80) ∅
 .540 (13.72) ∅

Side View
 .358 (9.09)
 .090 (2.29)
 .050 (1.27)
 .238 (6.05)
 .105 (2.67) ∅
 .590 (14.99) ∅
 .025 SQ. (.64 SQ.)
 .702 (17.83) ∅

* May be available from distributor stock.
 ** See page FC20 for filter performance.
 Standard Tolerance = ±.005 except where noted, ∅ = ±.015

Dimensions in inches (mm)

37 Series 700 Shell Size Pin Contact



Solderless Wire Wrap

Spectrum Part Number <i>Select one</i>	EMI Filter				
	L .500	L .375	L .250	Filter Desig.**	Cap. Value
56-731 -006 -023 -018				A	310 pF Pi
56-731 -007 -024 -019				B	1000 pF C
56-731 -008 -025 -020				C	1000 pF Pi
56-731 -009 -026 -021				D	5000 pF C
56-731 -010 -027 -022				E	4000 pF Pi
56-731 -037 -034 -031				F	830 pF C
56-731 -038 -035 -032				J	100 pF Pi
56-731 -039 -036 -033				K	2500 pF Pi
56-731 -051 -050 -049				N	375 pF C

Solder Cup Termination

Spectrum Part Number	EMI Filter	
	Filter Designation**	Cap. Value
* 56-731-011	A	310 pF Pi
56-731-012	B	1000 pF C
* 56-731-013	C	1000 pF Pi
56-731-014	D	5000 pF C
* 56-731-015	E	4000 pF Pi
* 56-731-040	F	830 pF C
56-731-041	J	100 pF Pi
56-731-042	K	2500 pF Pi
56-731-060	N	375 pF C
56-731-077	L	500 pF C

* May be available from distributor stock.
** See page FC20 for filter performance.
Standard Tolerance = ±.005 except where noted, ∅ = ±.015

Dimensions in inches (mm)

37 Series 700 Shell Size Socket Contact



Printed Circuit Board Mount

Spectrum Part Number	EMI Filter	
	Filter Designation**	Cap. Value
56-733-001	A	310 pF Pi
56-733-002	B	1000 pF C
56-733-003	C	1000 pF Pi
56-733-004	D	5000 pF C
56-733-005	E	4000 pF Pi
56-733-021	F	830 pF C
56-733-022	J	100 pF Pi
56-733-023	K	2500 pF Pi
56-733-035	N	375 pF C
56-733-046	L	500 pF C

Printed Circuit Board Right Angle Mount

Spectrum Part Number	EMI Filter	
	Filter Designation**	Cap. Value
56-734-001	A	310 pF Pi
56-734-002	B	1000 pF C
56-734-003	C	1000 pF Pi
56-734-004	D	5000 pF C
56-734-005	E	4000 pF Pi
56-734-006	F	830 pF C
56-734-007	J	100 pF Pi
56-734-008	K	2500 pF Pi
56-734-012	N	375 pF C
56-734-021	L	500 pF C

* May be available from distributor stock.

** See page FC20 for filter performance.

Standard Tolerance = ± 0.005 except where noted, $\diamond = \pm 0.015$

Dimensions in inches (mm)

37 Series 700 Shell Size Socket Contact & Pin/Socket Adapter



Solderless Wire Wrap

Spectrum Part Number <i>Select one</i>	EMI Filter			Filter Desig.**	Cap. Value	
	L .500	L .375	L .250			
* 56-733 -006	-016	* -011	A	310 pF Pi		
56-733 -007	-017	-012	B	1000 pF C		
56-733 -008	-018	-013	C	1000 pF Pi		
56-733 -009	-019	-014	D	5000 pF C		
56-733 -010	-020	-015	E	4000 pF Pi		
56-733 -030	-027	-024	F	830 pF C		
56-733 -031	-028	-025	J	100 pF Pi		
56-733 -032	-029	-026	K	2500 pF Pi		
56-733 -038	-037	-036	N	375 pF C		

Solder Cup Termination

Spectrum Part Number	EMI Filter		
	Filter Designation**	Cap. Value	
* 56-736-001	A	310 pF Pi	
56-736-002	B	1000 pF C	
* 56-736-003	C	1000 pF Pi	
56-736-004	D	5000 pF C	
* 56-736-005	E	4000 pF Pi	
56-736-006	F	830 pF C	
56-736-007	J	100 pF Pi	
* 56-736-008	K	2500 pF Pi	
56-736-009	N	375 pF C	
56-736-015	L	500 pF C	

Pin/Socket Adapter

Spectrum Part Number	EMI Filter		
	Filter Designation**	Cap. Value	
* 56-735-001	A	310 pF Pi	
56-735-002	B	1000 pF C	
* 56-735-003 €	C	1000 pF Pi	
56-735-004	D	5000 pF C	
* 56-735-005 €	E	4000 pF Pi	
* 56-735-008	F	830 pF C	
56-735-009	J	100 pF Pi	
56-735-010	K	2500 pF Pi	
56-735-025	N	375 pF C	
56-735-034	L	500 pF C	

€ Also available through API's authorized European distributors/agents.

* May be available from distributor stock.

** See page FC20 for filter performance.

Standard Tolerance = ±.005 except where noted, $\phi = \pm.015$

Dimensions in inches (mm)

50 Series 700
Shell Size Pin Contact



Printed Circuit Board Mount

Spectrum Part Number	EMI Filter	
	Filter Designation**	Cap. Value
56-741-001	A	310 pF Pi
56-741-002	B	1000 pF C
56-741-003	C	1000 pF Pi
56-741-004	D	5000 pF C
56-741-005	E	4000 pF Pi
56-741-027	F	830 pF C
56-741-028	J	100 pF Pi
56-741-029	K	2500 pF Pi
56-741-042	N	375 pF C
56-741-066	L	500 pF C

Printed Circuit Board Right Angle Mount

Spectrum Part Number	EMI Filter	
	Filter Designation**	Cap. Value
56-742-001	A	310 pF Pi
56-742-002	B	1000 pF C
56-742-003	C	1000 pF Pi
56-742-004	D	5000 pF C
56-742-005	E	4000 pF Pi
56-742-006	F	830 pF C
56-742-007	J	100 pF Pi
56-742-008	K	2500 pF Pi
56-742-009	N	375 pF C
56-742-022	L	500 pF C

* May be available from distributor stock.
** See page FC20 for filter performance.
Standard Tolerance = ±.005 except where noted, ∅ = ±.015

Dimensions in inches (mm)

50 Series 700 Shell Size Pin Contact



Solderless Wire Wrap

Spectrum Part Number <i>Select one</i>	EMI Filter				
	L .500	L .375	L .250	Filter Desig.**	Cap. Value
56-741 -006 -022 -017				A	310 pF Pi
56-741 -007 -023 -018				B	1000 pF C
56-741 -008 -024 -019				C	1000 pF Pi
56-741 -009 -025 -020				D	5000 pF C
56-741 -010 -026 -021				E	4000 pF Pi
56-741 -036 -033 -030				F	830 pF C
56-741 -037 -034 -031				J	100 pF Pi
56-741 -038 -035 -032				K	2500 pF Pi
56-741 -045 -044 -043				N	375 pF C

Mating Face

Termination Face

Side View

Solder Cup Termination

Spectrum Part Number	EMI Filter	
	Filter Designation**	Cap. Value
* 56-741-011	A	310 pF Pi
* 56-741-012	B	1000 pF C
* 56-741-013	C	1000 pF Pi
* 56-741-014	D	5000 pF C
* 56-741-015	E	4000 pF Pi
56-741-039	F	830 pF C
56-741-040	J	100 pF Pi
56-741-041	K	2500 pF Pi
56-741-063	N	375 pF C
56-741-067	L	500 pF C

Mating Face

Termination Face

Side View

* May be available from distributor stock.
 ** See page FC20 for filter performance.
 Standard Tolerance = ±.005 except where noted, ∅ = ±.015

Dimensions in inches (mm)

50 Series 700 Shell Size Socket Contact



Printed Circuit Board Mount

Spectrum Part Number	EMI Filter		Mating Face	Termination Face	Side View
	Filter Designation**	Cap. Value			
56-743-001	A	310 pF Pi			
56-743-002	B	1000 pF C			
56-743-003	C	1000 pF Pi			
56-743-004	D	5000 pF C			
56-743-005	E	4000 pF Pi			
56-743-021	F	830 pF C			
56-743-022	J	100 pF Pi			
56-743-023	K	2500 pF Pi			
56-743-033	N	375 pF C			
56-743-043	L	500 pF C			

Printed Circuit Board Right Angle Mount

Spectrum Part Number	EMI Filter		Mating Face	Termination Face	Side View	Bottom View
	Filter Designation**	Cap. Value				
56-744-001	A	310 pF Pi				
56-744-002	B	1000 pF C				
56-744-003	C	1000 pF Pi				
56-744-004	D	5000 pF C				
56-744-005	E	4000 pF Pi				
56-744-006	F	830 pF C				
56-744-007	J	100 pF Pi				
56-744-008	K	2500 pF Pi				
56-744-009	N	375 pF C				
56-744-012	L	500 pF C				

* May be available from distributor stock.

** See page FC20 for filter performance.

Standard Tolerance = ±.005 except where noted, ∅ = ±.015

Dimensions in inches (mm)

50 Series 700 Shell Size Pin/Socket Adapter



Solderless Wire Wrap

Spectrum Part Number <i>Select one</i>	EMI Filter			Filter Design.**	Cap. Value		
	L .500	L .375	L .250				
56-743 -006	-016	-011	A	310 pF Pi			
56-743 -007	-017	-012	B	1000 pF C			
56-743 -008	-018	-013	C	1000 pF Pi			
56-743 -009	-019	-014	D	5000 pF C			
56-743 -010	-020	-015	E	4000 pF Pi			
56-743 -030	-027	-024	F	830 pF C			
56-743 -031	-028	-025	J	100 pF Pi			
56-743 -032	-029	-026	K	2500 pF Pi			
56-743 -036	-035	-034	N	375 pF C			

Solder Cup Termination

Spectrum Part Number	EMI Filter			
	Filter Designation**	Cap. Value		
56-746-001	A	310 pF Pi		
56-746-002	B	1000 pF C		
56-746-003	C	1000 pF Pi		
56-746-004	D	5000 pF C		
56-746-005	E	4000 pF Pi		
56-746-006	F	830 pF C		
56-746-007	J	100 pF Pi		
56-746-008	K	2500 pF Pi		
56-746-009	N	375 pF C		
56-746-018	L	500 pF C		

Pin/Socket Adapter

Spectrum Part Number	EMI Filter			
	Filter Designation**	Cap. Value		
* 56-745-001	A	310 pF Pi		
56-745-002	B	1000 pF C		
* 56-745-003	C	1000 pF Pi		
56-745-004	D	5000 pF C		
* 56-745-005	E	4000 pF Pi		
56-745-006	F	830 pF C		
56-745-007	J	100 pF Pi		
56-745-008	K	2500 pF Pi		
56-745-019	N	375 pF C		
56-745-027	L	500 pF C		

* May be available from distributor stock.

** See page FC20 for filter performance.

Standard Tolerance = ±.005 except where noted, ϕ = ±.015

Dimensions in inches (mm)

D-Subminiature Part Numbering System

Ordering Information

Example: **56-513-012-TI**

56 - **5** **1** **3** - **0** **12** - **TI**



To assist your efforts in selecting the correct Filtered Connector to meet your needs, we have developed a part numbering system. All of the standard products are shown in their respective catalog pages.

Part number **56-513-012-TI** represents a Series 500 connector with 15 contacts in a socket to straight PCB mount configuration. All connector positions have a capacitance value of 840 pF and there are 4-40 threads on mounting flange.

D-Subminiature Connector Options

Threaded Inserts

Available on Series 500, 600 & 700

- #4-40 UNC or metric M3.0 threaded inserts in mounting flanges
- Allows ease of panel-assembly
- Plated steel inserts with last thread upset for torque

Grounding Bracket

For right angle mount PCB connectors, available on Series 700

- Metal bracket in place of plastic
- Provides ground connection direct from circuit board
- Allows shell grounding to board
- Includes 4-40 threads

Stand-off with Board Lock Feature

For straight PCB connectors, available on Series 700

- Allows shell grounding to board
- Eliminates stress on filter terminations
- Tin plated brass stand-off with snap-in feature
- Available for .062" (1.57mm) or .093" (2.36mm) thick boards

Grounding Bracket with Board Lock

For right angle mount PCB connectors, available on Series 500 & 700

- Metal bracket provides grounding
- Snap-in, no hardware needed, 4-40 threads included
- For use on .062" (1.57mm) thick boards

Gold Plating

Available on Series 600 & 700

- High reliability applications, 50µ" (1.27 µm) gold over 50µ" (1.27 µm) nickel

Solder Dipped Tails

Available on Series 600 & 700 connectors

- Solder dipped tails added to standard gold flash

Water Block

Consult API engineers for specifics.

- Internally sealed in accordance with NEMA Standard Rain Test section 6.4 (also UL50 part 28 ram test for submersion, section 6.10.1)



Dimensions in inches (mm)

Filtered Combo D-Subminiature Connectors

API's Spectrum Control line of filtered combo D-sub provide high insertion loss with capacitive filtering. These connectors are available with 20 Amp power contacts or 40 Amp power contacts. Configurations include male and female versions with straight PC terminals, right angle PC terminals or solder cup terminals. Standard D-sub shell sizes provide intermateability with unfiltered connectors. High strength epoxy potting protects ceramic elements.

Capacitive filtering is available in 470, 820, 1000 and 1500 pF. Additional capacitance ranges and configurations can be provided upon request. Please consult factory for more information.

Applications

- Telecommunications base station equipment
- Switching and transmission equipment
- Power supplies
- Industrial equipment
- Computer work stations

Ordering Information

Example: **563A03W3101GBL9**



* Insert "F" for RoHS compliant



Mechanical Specifications

<i>Shell</i>	Steel, tin plated
<i>Power Contacts</i>	Brass, gold plated .000030 in. (0.762 μm) minimum
<i>Signal Contacts</i>	Pin: brass, gold plated .000015 in. (0.762 μm) min. Socket: copper alloy, gold plated .000030 in. (0.762 μm) min.
<i>Insulator</i>	Glass-filled polyester, flammability UL94V-0
<i>Operating Temperature</i>	-55°C to +125°C
<i>Capacitors</i>	MLCC

Electrical Specifications

<i>Operating Voltage</i>	200 VDC
<i>Current Rating*</i>	40 Amp power/ 5 Amp signal
<i>Insulation Resistance</i>	1 Gohm at 100 VDC
<i>Capacitance</i>	See below for MLCC values. For other capacitance values contact factory.

<i>Dielectric Withstanding Voltage</i>	600 VDC
--	---------

*30 Amp available. Consult factory.

Filtered Combo D-Subminiature Connectors 3W3

Plug - Solder Cup



Only represents a few of our available configurations. Consult factory for more information.

Dimensions in inches (mm)

Filtered Combo D-Subminiature Connectors 3W3

Plug - Right Angle



Only represents a few of our available configurations. Consult factory for more information.

Dimensions in inches (mm)

Filtered Combo D-Subminiature Connectors 5W5

Plug - Vertical



Only represents a few of our available configurations. Consult factory for more information.

Dimensions in inches (mm)

Filtered Combo D-Subminiature Connectors 9W4

Socket - Solder Cup

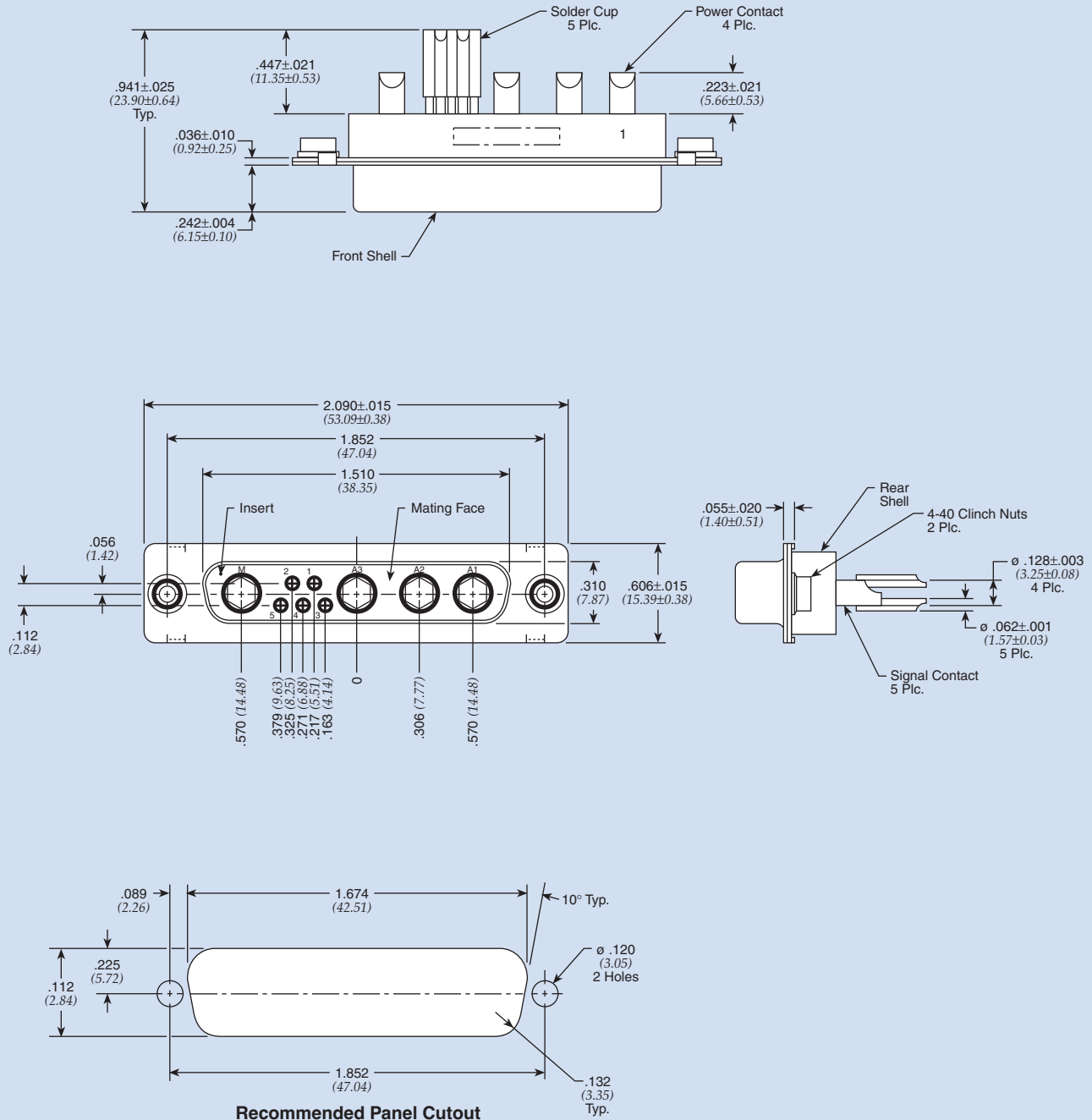

Only represents a few of our available configurations. Consult factory for more information.

Dimensions in inches (mm)

Filtered Combo D-Subminiature Connectors 9W4

Socket - Vertical



Only represents a few of our available configurations. Consult factory for more information.

Dimensions in inches (mm)

Filtered Combo D-Subminiature Connectors 9W4

Plug - Right Angle



Recommended PC Board Mounting Dimensions

Only represents a few of our available configurations. Consult factory for more information.

Dimensions in inches (mm)

Filtered Combo D-Subminiature Connectors 24W7

Socket - Solder Cup



Only represents a few of our available configurations. Consult factory for more information.

Dimensions in inches (mm)

D-Subminiature Adapter Test Kit & Hardware

Adapter Test Kit

Specially designed for EMI evaluation process

- Male/female adapter part
- Easily plugged into equipment under testing conditions
- Ideal for new products and retrofitting
- Each adapter test kit includes:
 - 20 filtered adapters
 - Four shell sizes 9, 15, 25 and 37
 - Four filter ranges:
 - Series 700**
 - 310 pF Pi
 - 830 pF FT
 - 1000 pF Pi
 - 4000 pF Pi

Ordering Information

Description	API Part Number
Adapter test kit	56-700-002
Adapter test kit with Jackscrew <i>Includes 40 pcs. 56-201-006</i>	56-700-002-JS
Hexagonal Spacer	56-201-001 (1 per)
Jackscrew Mounting Hardware <i>For .312" (7.92 mm) length</i>	56-201-004 (1 per)
Jackscrew Mounting Hardware <i>For .688" (17.47 mm) length</i>	56-201-006 (2 per)
Tubular Spacer	56-201-003 (1 per)



Adapter Test Kit

Hardware

Designed to provide simple and effective mounting

Hexagonal Spacer

- Tapped spacer fits between flanges
- Provide retrofit of 4-40" threads
- Two spacers per adapter required, packaged in bulk



Jackscrew Mounting Hardware

- Male/female jackscrews
- Standard 4-40 threads for compatibility
- Two male thread lengths available
- Two screws per adapter required
- Lockwasher included, packaged in bulk

Micro D Series Filtered Connectors

For designs that require even smaller connector packages, API's Spectrum Control brand has designed a line of filtered Micro D-Subminiature connectors. This line of connectors offers a range of reliable filtering options, including capacitive and ESD versions, and several sizes and termination options. API has a Micro D-sub connector to satisfy your smallest space constraints.

Features

- Light weight
- Compact size
- Environmentally sealed contact area when mated
- Corrosion resistant
- Durable (500 cycles min.)
- Superior electrical performance
- RoHS compliant



Mechanical Specifications

<i>Shell</i>	Aluminum, electroless nickel plated 500 μ in (12.7 μm) minimum
<i>Insulator</i>	High temperature plastic, flammability UL94V-0
<i>Contacts</i>	Copper alloy, gold plated 50 μ in (1.27 μm) minimum
<i>Potting</i>	Flammability UL94V-0
<i>Interfacial Seal</i>	Silicon

Electrical Specifications

<i>Operating Voltage</i>	100 VDC
<i>Dielectric Withstanding Voltage</i>	300 VDC
<i>Current Rating</i>	3 Amps
<i>Insulation Resistance</i>	5G ohms @ 100 VDC

Ordering Information

Example: **56-F011-110-JP**



This part number represents a micro D-sub connector with a shell size of 15 and a pin to solder cup configuration. All lines are filtered with same capacitance value, which is 100 pF COB. The connector includes an optional #2-56 jack post.

* Right angle and PC tail length is 0.109. Other lengths available, consult factory.

All capacitance values ±20% @ 25°C

Micro D Series Filtered Connectors

High Performance

Filter Designation	Type	Capacitance		Dielectric Withstanding Voltage	Working Voltage DC -55°C to +125°C	Minimum Insertion Loss - Decibels (dB) 50 ohm system per MIL-STD-220 (no load)							
		Value	Tolerance			5 MHz	10 MHz	20 MHz	50 MHz	100 MHz	200 MHz	500 MHz	1 GHz
01	FT	100 pF	±20%	300V	100V	—	—	—	—	1	6	14	20
02	FT	470 pF	±20%	300V	100V	—	—	2	8	14	20	28	34
03	FT	820 pF	±20%	300V	100V	—	2	6	13	19	25	33	39
04	FT	1500 pF	±20%	300V	100V	—	5	10	18	24	30	38	44
05	FT	4700 pF	±20%	300V	100V	8	14	20	28	34	40	48	54

Standard Performance

Filter Designation	Type	Capacitance		Dielectric Withstanding Voltage	Working Voltage DC -55°C to +125°C	Minimum Insertion Loss - Decibels (dB) 50 ohm system per MIL-STD-220 (no load)							
		Value	Tolerance			5 MHz	10 MHz	20 MHz	50 MHz	100 MHz	200 MHz	500 MHz	1 GHz
10	COB	100 pF	±20%	300V	100V	—	—	—	—	1	6	14	20
11	COB	470 pF	±20%	300V	100V	—	—	2	8	14	20	28	32
12	COB	820 pF	±20%	300V	100V	—	2	6	13	19	25	32	32
13	COB	1500 pF	±20%	300V	100V	—	5	10	18	24	30	32	32
14	COB	4700 pF	±20%	300V	100V	8	14	20	28	32	32	32	32

Right Angle PCB

Receptacle



Plug



Size	A	B	C (RCPT)	C (Plug)	D	E	F	G	H
9	.775 (19.69)	.565 (14.35)	.388 (9.86)	.330 (8.38)	.390 (9.91)	4	5	.200 (5.08)	.250 (6.35)
15	.925 (23.50)	.715 (18.16)	.538 (13.67)	.480 (12.19)	.540 (13.72)	7	8	.350 (8.89)	.400 (10.16)
21	1.075 (27.31)	.865 (21.97)	.688 (17.48)	.630 (16.00)	.690 (17.53)	10	11	.500 (12.70)	.550 (13.97)
25	1.175 (29.85)	.965 (24.51)	.788 (20.02)	.730 (18.54)	.790 (20.07)	12	13	.600 (15.24)	.650 (16.51)
31	1.325 (33.66)	1.115 (28.32)	.938 (23.83)	.880 (22.35)	.940 (23.88)	15	16	.750 (19.05)	.800 (20.32)
37	1.475 (37.47)	1.265 (32.13)	1.088 (27.64)	1.030 (26.16)	1.090 (27.69)	18	19	.900 (22.86)	.950 (24.13)

Dimensions in inches (mm)

Micro D Series Filtered Connectors

Size	A	B	C (RCPT)	C (Plug)	D
9	.775 (19.69)	.565 (14.35)	.388 (9.86)	.330 (8.38)	.390 (9.91)
15	.925 (23.50)	.715 (18.16)	.538 (13.67)	.480 (12.19)	.540 (13.72)
21	1.075 (27.31)	.865 (21.97)	.688 (17.48)	.630 (16.00)	.690 (17.53)
25	1.175 (29.85)	.965 (24.51)	.788 (20.02)	.730 (18.54)	.790 (20.07)
31	1.325 (33.66)	1.115 (28.32)	.938 (23.83)	.880 (22.35)	.940 (23.88)
37	1.475 (37.47)	1.265 (32.13)	1.088 (27.64)	1.030 (26.16)	1.090 (27.69)

Dimensions in inches (mm)

Vertical PCB

Receptacle

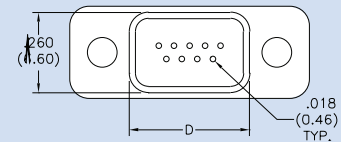

Plug

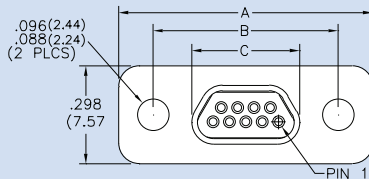

Solder Cup

Receptacle



Plug



Micro D Series Filtered Connectors Options

JP - #2-56 Jack Post M83513/05-07



JS - #2-56 Jack Screw M83513/05-05



TI - Threaded Insert Receptacle



TI - Threaded Insert Plug



GB - Ground Bracket Receptacle



GB - Ground Bracket Plug



Micro D Series Filtered Connectors Board and Panel Cutouts

Vertical PCB Layouts

Pin Connector Shown

9 Contacts



15 Contacts



21 Contacts



25 Contacts



31 Contacts



37 Contacts

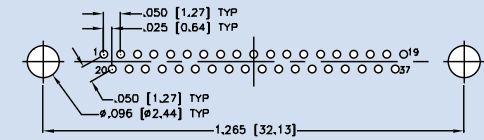

Right Angle PCB Layouts

Pin Connector Shown

9 Contacts



15 Contacts

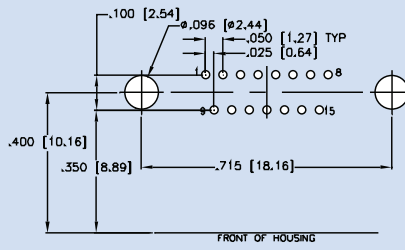

21 Contacts

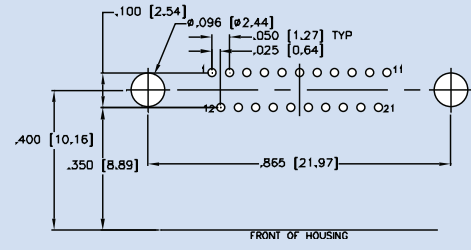

25 Contacts



31 Contacts



37 Contacts



Notes: PC Tail Diameter 0.018 ±0.002 (0.46 ±0.05) Contact numbers shown are pin connector.
Reverse for socket. Patterns shown are for connector mounting side of PC board.

Filtered Miniature Ribbon Connectors

Filtered miniature ribbon connectors are fully intermateable and interchangeable with existing standard product. Rugged design construction and predictable capacitive filter performance is available in right-angle and male/female adapter versions.

Applications for this type of connector are widely diversified and include all phases of the telecommunications industry including original telephone manufacturing, operating telephone companies, cable reclamation, cable manufacturing and bay connectorization. The filtered miniature ribbon connector line is also ideally suited for use in printers, computer terminals, test equipment, business and copying machines, telemetering, and various equipment used in the security industry.

Features

- Lower installed cost
- Assists with FCC Part 15; available for Part 68 requirements
- Applicable for VDE specifications 0871, 0875-0878, Vfg Federal Regulations and VCCI noise requirements
- Drop-in replacement, matched footprint
- All circuit lines filtered
- Connector body is recognized under the Component Recognition Program of Underwriters Laboratories, Inc.
- Plastic components are UL94V-0 rated
- Connector body is certified by Canadian Standard Association

Mechanical Specifications - Adapter

Shell Zinc
 Thermoplastic
 Insert Black, high strength
 Contacts Copper alloy
 Contact Plating 30uin (.76um) (min.)
 gold over nickel

Mechanical Specifications - Connector

Shell Steel, tin plated
 Thermoplastic
 Insert Blue, 30% glass filled
 Contacts Phosphor bronze
 Contact Plating Gold flash (<10 µ in) over nickel

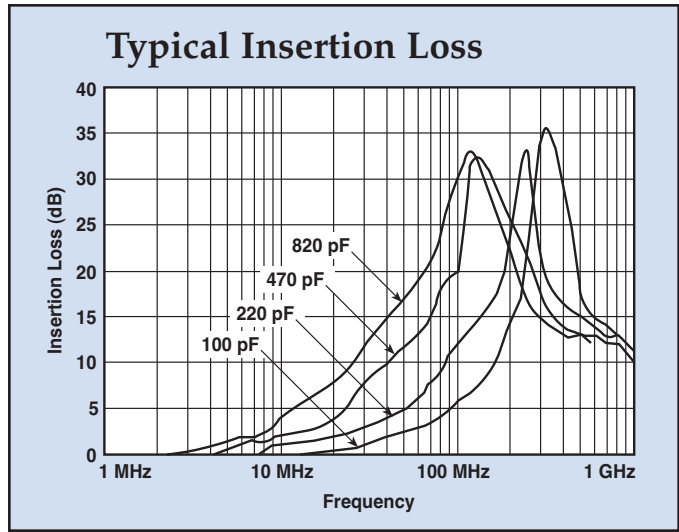

Electrical Specifications

Operating Temperature -55°C - 105°C
 Dielectric Withstanding Voltage 1000 VAC min per (FCC Part 68 test)
 Capacitance 100 pF, 220 pF, 470 pF, 820 pF, ±15% (adapter), ±20% (connector)
 Dissipation Factor 2.5% max (adapter) 5% max (connector)

Filtered Miniature Ribbon Connectors 50 Position



Part Number	Capacitance Value
56-882-002	100 pF, ±20%
56-882-003	220 pF, ±20%
56-882-004	470 pF, ±20%
56-882-005	820 pF, ±20%

Filtered Miniature Ribbon Connectors 50 Position



Part Number	Capacitance Value
56-886-002	100 pF, ±20%
56-886-003	220 pF, ±20%
56-886-004	470 pF, ±20%
56-886-005	820 pF, ±20%

Filtered Miniature Ribbon Connectors 50 Position

Adapter



Dimensions in inches (mm)

Part Number	Capacitance Value
56-889-002	100 pF ±15%
56-889-003	220 pF ±15%
56-889-004	470 pF ±15%
56-889-005	820 pF ±15%

Hardware options also available. Consult factory for more information.

Filtered Modular Jack Connectors

Protecting signals from electromagnetic interference (EMI) is now more important than ever. API's Spectrum Control brand gives you more choices in keeping your signals clean and free of EMI. Whatever the level of protection your application requires, we offer signal conditioning products that meet varied levels of price and performance.

These compact, low-cost, filtered printed circuit board RJ45 modular jack connectors from API's Spectrum Control brand offers an inexpensive way to protect equipment from conducted and radiated electromagnetic interference (EMI), while meeting all appropriate performance requirements. Offering compact size and high reliability, these new connectors are fully intermateable and interchangeable with existing standard products. The low profile and narrow width of the multi-port style allows more ports to be packed into less space.

Filtered versions can be supplied in shielded or unshielded versions. Redundant shielding tabs ensure that a low impedance ground path is maintained across the interface. These flame retardant polyester thermoplastic connectors are compatible with wave solder environments, and utilize duplex plated contacts with solder tails.

Modular jack connectors assist with FCC Part 15 A & B; and CISPR 22 compliance.

Applications for this type of connector are widely diversified and include: LANs, WANs, network cards, broadband transmission equipment, workstations, peripherals, fax/modems, copy machines and multiplexing.

Features

- RoHS compliant
- Lower installed cost
- Assists with FCC Part 15 A & B; and CISPR 22 compliance
- Drop-in replacement, matched footprint
- All circuit lines protected
- Inductor, capacitor or ESD versions
- Unshielded or shielded versions
- Select lead versions available
- High temperature versions available for reflow processes



Typical Impedance vs. Frequency (Ferrite Version)



Typical Time Voltage Curves (ESD Version)



Typical Time-Voltage Curve of Transient Spike on Integrated Protected Connector with Capacitance (Parts with Working Voltage Code starting with 0)

Rugged USB Connectors

New rugged USB Connectors from API's Spectrum Control brand feature a heavy-duty design able to connect to USB 2.0 or 1.1 ports, making them ideal for demanding, high stress applications.

Product Highlights

- Connectors meet seal requirements of IEC-60529, Code IP67 on PCB side
- Meet immersion requirements per MIL-STD-810F, Method 512.4 to 20 meters (unmated)
- RoHS compliant
- Supplied with gasket
- Ideal for demanding applications in the military, communications, medical, industrial and computing industries
- Type A, right-angle mounted connector
- USB 2.0 or 1.1 applications
- Part Number: 56FU04-017



Electrical Specifications

Operating Temperature . . -40°C to +105°C

Current Rating 1.5 Amps

Contact Resistance 30 mΩ

Dimensions



Hooded Strain Reliefs

Hooded strain reliefs are used whenever a connector is used on a cable assembly which will be exposed to users and subject to multiple disconnects. Hoods are designed to protect users from shock hazard by exposed solder joints, as well as provide a strain relief for the wires and protection against accidental short circuits.

Since most filter connectors are larger than standard connectors, there had been a problem fitting most commercially available hoods. Spectrum Control solves this problem. Our hoods are molded of thin wall plastic, providing extra internal space to accommodate larger filter connectors. The hood is constructed of extremely durable polycarbonate and meets the flammability requirements for UL94V-0.

In addition, hoods are ideal for use on applications which require the use of extra components such as resistors or varistors on the wires. The nonconductive hood conveniently houses the connector, components, and protects any joints.

- **2560-9000-XX** is supplied with metal retention clips to hold the connector within the hood assembly. This item is recommended for use with Spectrum Filtered D-sub's, most other filtered D-sub's, and most standard D-sub's.
- **2560-9001-XX** is meant to be used with a connector which has a special eyelet on the mounting flange. This feature is available as an option on the Spectrum Filtered D-sub. Contact factory for additional information.

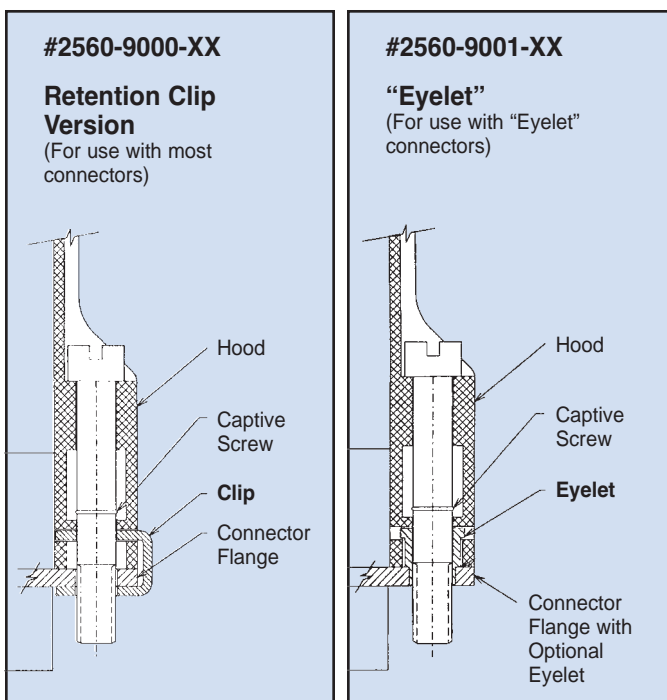

Ordering Information and Dimensions

Part Number	Connector Size	A ±.005	B Max	C Max	D Max	E Max	F Max
2560-9000-01 2560-9001-01	9	0.984 (24.99)	1.228 (31.19)	1.710 (43.43)	0.985 (25.02)	.685 (17.40)	.240 (6.07)
2560-9000-02 2560-9001-02	15	1.312 (33.33)	1.556 (39.52)	1.710 (43.43)	1.310 (26.71)	.685 (17.40)	.300 (7.62)
2560-9000-03 2560-9001-03	25	1.852 (47.04)	2.103 (53.42)	1.710 (43.43)	1.850 (46.99)	.685 (17.40)	.400 (10.16)
2560-9000-04 2560-9001-04	37	2.500 (63.50)	2.744 (69.70)	1.710 (43.43)	2.500 (63.50)	.685 (17.40)	.400 (10.16)

Dimensions in inches (mm)

Custom Engineered Solutions

Despite the breadth of our filtered connector product line, there exist certain applications which demand a custom EMC solution. Our engineering staff will work with your design team to provide a custom filtered connector which meets your individual requirements. Examples of custom projects are shown below.

Special Mounting Flanges

- Housings can be designed to be integrated into the customer's equipment. The housings are constructed of machined materials, or precision diecast zinc.

Value-added Assemblies

- API's capabilities extend beyond just supplying filter connectors. Additional operations such as sourcing and assembling flexible circuits, adding flying leads, or making connector to connector assemblies, all can be provided in conjunction with the filter connector.

Custom Filter Arrangements

- Complex filters involving unbalanced Pi types, LC types with large inductive components, special pin-in to pin-out translations, and overvoltage protective devices such as diodes and varistors can be packaged within the connector.

Other Connector Formats

- Manufacturer specific connectors also can be filtered. Our involvement ranges from complete design to implementing minor modifications to include the addition of the filter components. Medical equipment and hand-held devices are examples of excellent applications for these connectors.

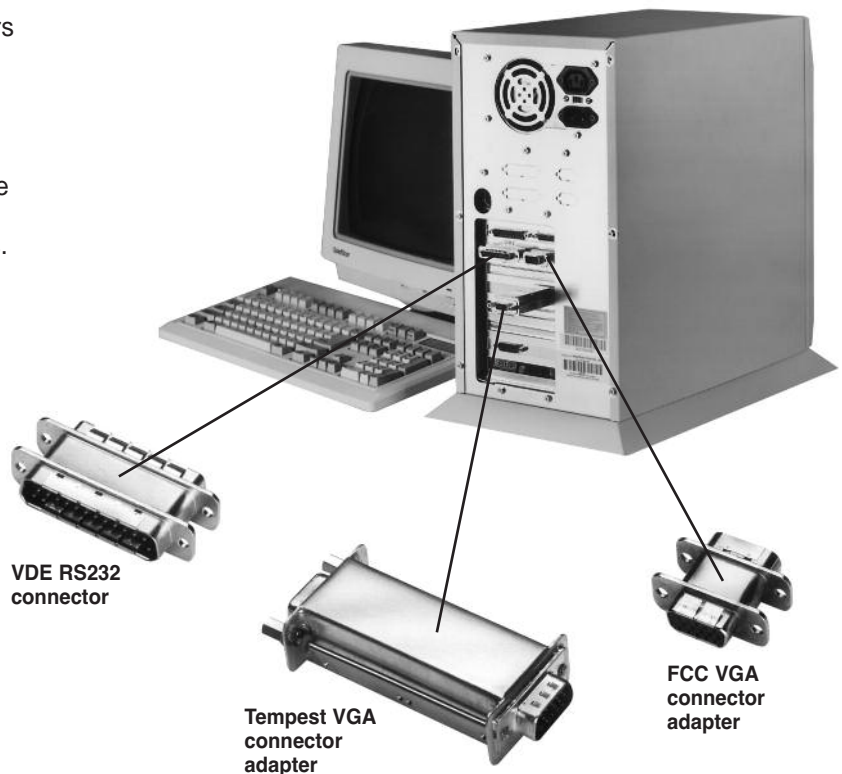

Filtered Connector Performance Specifications

The filtered D-subminiature connectors shown in this catalog have been designed and tested to the following test plan.

The information shown can be used as a basis for your filtered connector specifications. (Contact API for additional details.)

Test Group	Order of Test	Examination of Test	Test Method	Post Test Requirements
I	1	Visual and Mechanical Examination		In accordance with applicable requirements.
	2	Materials, Designs Construction and Workmanship		
	3	Physical Dimensions and Marking		
	4	Capacitance	MIL-STD-202 Method 305 1 KHz, 1VRMS max. 25°C	Within specified tolerance.
	5	Dielectric Withstanding Voltage	MIL-STD-202 Method 301	No breakdown or damage.
	6	Insulation Resistance	MIL-STD-202 Method 302, test condition at rated voltage	5000 megohm minimum.
	7	Insertion Loss	MIL-STD-220 No load	In accordance with applicable requirements.
II	1	Contact Engagement and Separation	MIL-C-24308, Para. 3.5.10	Maximum engagement force 18.0 oz., minimum separation force 0.7 oz.
	2	Mating and Unmating Force	MIL-C-24308, Para. 3.5.4	MIL-C-24308, Para. 3.5.4 Table II Limits: Shell size 1-5, class G only.
	3	Durability	MIL-C-24308, Para. 3.5.16, 4.7.18, except 100 cycles	MIL-C-24308, Para. 3.5.9 Contact resistance at 1 amp. 20 millohms max.
	4	Thermal Shock	MIL-STD-202 Method 107, Test condition B, -55°C to +125°C	No evidence of damage. Insulation resistance not less than 2500 megohms.
	5	Solderability	MIL-STD-202; Method 208, RMA-Flux	Terminals shall meet solderability requirements.
	6	Moisture Resistance	MIL-STD-202 Method 106, less step seven	Insulation resistance not less than 500 megohms. Meet dielectric withstanding voltage requirements.
	7	Resistance to Soldering Heat	MIL-STD-202 Method 210, Test condition D	Insulation resistance not less than 500 megohms. Meet dielectric withstanding voltage requirements.
III	1	Vibration	MIL-STD-202 Method 204, Test condition D, 100 mA, current	No interruption of current flow longer than 1 microsecond. Insulation resistance greater than 5000 megohms.
	2	Shock	MIL-STD-202 Method 213, Test Condition G, 100 mA, current	No interruptions of current flow longer than 1 microsecond.
				Contact resistance at 1 amp. 15 millohms max.
				Capacitance within specified limits.
3	Mounting Inserts a. Prevailing torque (locking) b. Installation torque (locking) c. Push-out Force	IFI-100	a. 3 inch-pounds max. b. 6 inch-pounds without damage c. 10 pounds axial force without loosening insert	
IV	1	Life	MIL-STD-202 Method 108, Test condition D, within 125% of rated voltage at the maximum operating temperature.	Filter shall meet all initial requirements except insulation resistance shall not be less than 500 megohms.

Board & Panel Cutouts



Printed Circuit
Vertical Board Mount (standard density)



Printed Circuit
Right Angle Mount (standard density)

Board Layout (Pin and Socket Contact) for Standard D-Sub Connectors

Shell Size	A	B	C	D	E	F	G	H	I (Dia.)	J
9 (0)	.984 (25.00)	.436 = 4 x .109 (11.07) (2.77)	.327 = 3 x .109 (8.31) (2.77)	.492 (12.50)			PCB Mount .056 (1.42)			
15 (1)	1.312 (33.32)	.763 = 7 x .109 (19.38) (2.77)	.654 = 6 x .109 (16.61) (2.77)	.656 (16.66)			PCB Mount Rt Angle .275 (6.99)	.125 (3.18)	.045 (1.14)	.054 (1.37)
25 (2)	1.852 (47.04)	1.308 = 12 x .109 (33.22) (2.77)	1.199 = 11 x .109 (30.45) (2.77)	.926 (23.52)	.109 (2.77)	.112 (2.84)	0.112 2 rows			
37 (3)	2.500 (63.50)	1.962 = 18 x .109 (49.83) (2.77)	1.853 = 17 x .109 (47.07) (2.77)	1.250 (31.75)						
50 (4)	2.406 (61.11)	1.744 = 16 x .109 (44.30) (2.77) 2 rows	1.635 = 15 x .109 (41.35) (2.77) 1 row	1.203 (30.56)			0.00 1 row			

Panel Cutouts (Front or Rear Mounting) for Standard and High-Density D-Sub Connectors

Shell Size	A ±.015 (.38)	B ±.015 (.38)	C ±.015 (.38)	D ±.015 (.38)	E ±.003 (.08)	F ±.005 (.13)	G ±.002 (.05)	Diagram
9 (0)	.984 (24.99)	.492 (12.49)	.777 (19.74)	.388 (9.87)	.440 (11.18)	.220 (5.59)	.150 (3.81)	
15 (1)	1.312 (33.32)	.656 (16.66)	1.105 (28.07)	.552 (14.03)	.440 (11.18)	.220 (5.59)	.150 (3.81)	
25 (2)	1.852 (47.04)	.926 (23.52)	1.645 (41.78)	.822 (20.89)	.440 (11.18)	.220 (5.59)	.150 (3.81)	
37 (3)	2.500 (63.50)	1.250 (31.75)	2.293 (58.24)	1.146 (29.12)	.440 (11.18)	.220 (5.59)	.150 (3.81)	
50 (4)	2.406 (61.11)	1.203 (30.55)	2.190 (55.63)	1.095 (27.81)	.550 (13.97)	.275 (6.98)	.150 (3.81)	

Dimensions in inches (mm)

Board & Panel Cutouts

15 High-Density Pin/PCB

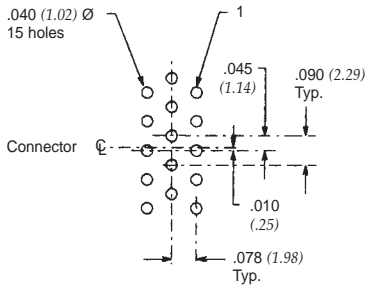

15 High-Density Socket/Right Angle



26 High-Density Pin/PCB



26 High-Density Socket/PCB



44 High-Density Pin/PCB

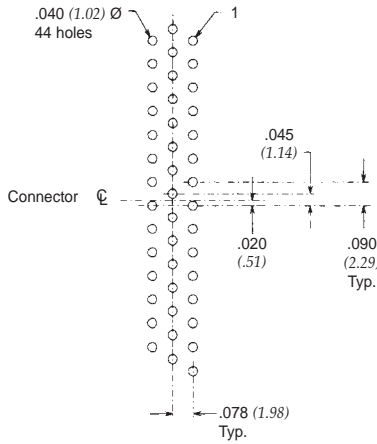

44 High-Density Socket/PCB



62 High-Density Pin/PCB



62 High-Density Socket/PCB



78 High-Density Socket/PCB Pin/PCB



Dimensions in inches (mm)



Стандарт Электрон Связь

Мы молодая и активно развивающаяся компания в области поставок электронных компонентов. Мы поставляем электронные компоненты отечественного и импортного производства напрямую от производителей и с крупнейших складов мира.

Благодаря сотрудничеству с мировыми поставщиками мы осуществляем комплексные и плановые поставки широчайшего спектра электронных компонентов.

Собственная эффективная логистика и склад в обеспечивает надежную поставку продукции в точно указанные сроки по всей России.

Мы осуществляем техническую поддержку нашим клиентам и предпродажную проверку качества продукции. На все поставляемые продукты мы предоставляем гарантию .

Осуществляем поставки продукции под контролем ВП МО РФ на предприятия военно-промышленного комплекса России , а также работаем в рамках 275 ФЗ с открытием отдельных счетов в уполномоченном банке. Система менеджмента качества компании соответствует требованиям ГОСТ ISO 9001.

Минимальные сроки поставки, гибкие цены, неограниченный ассортимент и индивидуальный подход к клиентам являются основой для выстраивания долгосрочного и эффективного сотрудничества с предприятиями радиоэлектронной промышленности, предприятиями ВПК и научно-исследовательскими институтами России.

С нами вы становитесь еще успешнее!

Наши контакты:

Телефон: +7 812 627 14 35

Электронная почта: sales@st-electron.ru

Адрес: 198099, Санкт-Петербург,
Промышленная ул, дом № 19, литера Н,
помещение 100-Н Офис 331