

### FEATURES

- Simple:** basic function is  $W = XY + Z$
- Complete:** minimal external components required
- Very fast:** Settles to 0.1% of full scale (FS) in 20 ns
- DC-coupled voltage output** simplifies use
- High differential input impedance** X, Y, and Z inputs
- Low multiplier noise:** 50 nV/ $\sqrt{\text{Hz}}$

### APPLICATIONS

- Very fast multiplication, division, squaring**
- Wideband modulation and demodulation**
- Phase detection and measurement**
- Sinusoidal frequency doubling**
- Video gain control and keying**
- Voltage-controlled amplifiers and filters**

### GENERAL DESCRIPTION

The AD835 is a complete four-quadrant, voltage output analog multiplier, fabricated on an advanced dielectrically isolated complementary bipolar process. It generates the linear product of its X and Y voltage inputs with a -3 dB output bandwidth of 250 MHz (a small signal rise time of 1 ns). Full-scale (-1 V to +1 V) rise to fall times are 2.5 ns (with a standard  $R_L$  of 150  $\Omega$ ), and the settling time to 0.1% under the same conditions is typically 20 ns.

Its differential multiplication inputs (X, Y) and its summing input (Z) are at high impedance. The low impedance output voltage (W) can provide up to  $\pm 2.5$  V and drive loads as low as 25  $\Omega$ . Normal operation is from  $\pm 5$  V supplies.

Though providing state-of-the-art speed, the AD835 is simple to use and versatile. For example, as well as permitting the addition of a signal at the output, the Z input provides the means to operate the AD835 with voltage gains up to about  $\times 10$ . In this capacity, the very low product noise of this multiplier (50 nV/ $\sqrt{\text{Hz}}$ ) makes it much more useful than earlier products.

The AD835 is available in an 8-lead PDIP package (N) and an 8-lead SOIC package (R) and is specified to operate over the -40°C to +85°C industrial temperature range.

### FUNCTIONAL BLOCK DIAGRAM



Figure 1.

### PRODUCT HIGHLIGHTS

1. The AD835 is the first monolithic 250 MHz, four-quadrant voltage output multiplier.
2. Minimal external components are required to apply the AD835 to a variety of signal processing applications.
3. High input impedances (100 k $\Omega$ ||2 pF) make signal source loading negligible.
4. High output current capability allows low impedance loads to be driven.
5. State-of-the-art noise levels achieved through careful device optimization and the use of a special low noise, band gap voltage reference.
6. Designed to be easy to use and cost effective in applications that require the use of hybrid or board-level solutions.

#### Rev. D

Information furnished by Analog Devices is believed to be accurate and reliable. However, no responsibility is assumed by Analog Devices for its use, nor for any infringements of patents or other rights of third parties that may result from its use. Specifications subject to change without notice. No license is granted by implication or otherwise under any patent or patent rights of Analog Devices. Trademarks and registered trademarks are the property of their respective owners.

**TABLE OF CONTENTS**

Features .....	1	Typical Performance Characteristics .....	7
Applications.....	1	Theory of Operation .....	10
General Description .....	1	Basic Theory .....	10
Functional Block Diagram .....	1	Scaling Adjustment .....	10
Product Highlights .....	1	Applications Information .....	11
Revision History .....	2	Multiplier Connections .....	11
Specifications.....	3	Wideband Voltage-Controlled Amplifier .....	11
Absolute Maximum Ratings.....	5	Amplitude Modulator .....	11
Thermal Resistance .....	5	Squaring and Frequency Doubling.....	12
ESD Caution.....	5	Outline Dimensions .....	13
Pin Configuration and Function Descriptions.....	6	Ordering Guide .....	14

**REVISION HISTORY****12/10—Rev. C to Rev. D**

Changes to Figure 1 .....	1
Changes to Absolute Maximum Ratings and Table 2.....	5
Added Figure 19, Renumbered Subsequent Tables.....	10
Added Figure 23.....	11

**10/09—Rev. B to Rev. C**

Updated Format .....	Universal
Changes to Figure 22.....	11
Updated Outline Dimensions .....	13
Changes to Ordering Guide .....	14

**6/03—Rev. A to Rev. B**

Updated Format .....	Universal
Updated Outline Dimensions .....	10

## SPECIFICATIONS

$T_A = 25^\circ\text{C}$ ,  $V_S = \pm 5\text{ V}$ ,  $R_L = 150\ \Omega$ ,  $C_L \leq 5\text{ pF}$ , unless otherwise noted.

Table 1.

Parameter	Conditions	Min	Typ	Max	Unit
TRANSFER FUNCTION		$W = \frac{(X1 - X2)(Y1 - Y2)}{U} + Z$			
INPUT CHARACTERISTICS (X, Y)					
Differential Voltage Range	$V_{CM} = 0\text{ V}$		$\pm 1$		V
Differential Clipping Level		$\pm 1.2^1$	$\pm 1.4$		V
Low Frequency Nonlinearity	$X = \pm 1\text{ V}, Y = 1\text{ V}$		0.3	$0.5^1$	% FS
	$Y = \pm 1\text{ V}, X = 1\text{ V}$		0.1	$0.3^1$	% FS
vs. Temperature	$T_{MIN}$ to $T_{MAX}^2$				
	$X = \pm 1\text{ V}, Y = 1\text{ V}$			0.7	% FS
	$Y = \pm 1\text{ V}, X = 1\text{ V}$			0.5	% FS
Common-Mode Voltage Range		$-2.5$		$+3$	V
Offset Voltage			$\pm 3$	$\pm 20^1$	mV
vs. Temperature	$T_{MIN}$ to $T_{MAX}^2$			$\pm 25$	mV
CMRR	$f \leq 100\text{ kHz}; \pm 1\text{ V p-p}$	$70^1$			dB
Bias Current			10	$20^1$	$\mu\text{A}$
vs. Temperature	$T_{MIN}$ to $T_{MAX}^2$			27	$\mu\text{A}$
Offset Bias Current			2		$\mu\text{A}$
Differential Resistance			100		k $\Omega$
Single-Sided Capacitance			2		pF
Feedthrough, X	$X = \pm 1\text{ V}, Y = 0\text{ V}$			$-46^1$	dB
Feedthrough, Y	$Y = \pm 1\text{ V}, X = 0\text{ V}$			$-60^1$	dB
DYNAMIC CHARACTERISTICS					
-3 dB Small Signal Bandwidth		150	250		MHz
-0.1 dB Gain Flatness Frequency			15		MHz
Slew Rate	$W = -2.5\text{ V to }+2.5\text{ V}$		1000		V/ $\mu\text{s}$
Differential Gain Error, X	$f = 3.58\text{ MHz}$		0.3		%
Differential Phase Error, X	$f = 3.58\text{ MHz}$		0.2		Degrees
Differential Gain Error, Y	$f = 3.58\text{ MHz}$		0.1		%
Differential Phase Error, Y	$f = 3.58\text{ MHz}$		0.1		Degrees
Harmonic Distortion	$X$ or $Y = 10\text{ dBm}$ , second and third harmonic Fund = 10 MHz			$-70$	dB
	Fund = 50 MHz			$-40$	dB
Settling Time, X or Y	To 0.1%, $W = 2\text{ V p-p}$		20		ns
SUMMING INPUT (Z)					
Gain	From Z to W, $f \leq 10\text{ MHz}$	0.990	0.995		
-3 dB Small Signal Bandwidth			250		MHz
Differential Input Resistance			60		k $\Omega$
Single-Sided Capacitance			2		pF
Maximum Gain	$X, Y$ to W, Z shorted to W, $f = 1\text{ kHz}$		50		dB
Bias Current			50		$\mu\text{A}$

# AD835

Parameter	Conditions	Min	Typ	Max	Unit
<b>OUTPUT CHARACTERISTICS</b>					
Voltage Swing	$T_{MIN}$ to $T_{MAX}$ <sup>2</sup> $X = Y = 0\text{ V}$ , $f < 10\text{ MHz}$	±2.2	±2.5		V
vs. Temperature		±2.0			V
Voltage Noise Spectral Density	$T_{MIN}$ to $T_{MAX}$ <sup>2</sup>		50		nV/ $\sqrt{\text{Hz}}$
Offset Voltage			±25	±75 <sup>1</sup>	mV
vs. Temperature <sup>3</sup>				±10	mV
Short-Circuit Current			75		mA
Scale Factor Error	$T_{MIN}$ to $T_{MAX}$ <sup>2</sup>		±5	±8 <sup>1</sup>	% FS
vs. Temperature					±9
Linearity (Relative Error) <sup>4</sup>	$T_{MIN}$ to $T_{MAX}$ <sup>2</sup>		±0.5	±1.0 <sup>1</sup>	% FS
vs. Temperature					±1.25
<b>POWER SUPPLIES</b>					
Supply Voltage		±4.5	±5	±5.5	V
For Specified Performance					
Quiescent Supply Current	$T_{MIN}$ to $T_{MAX}$ <sup>2</sup>		16	25 <sup>1</sup>	mA
vs. Temperature					26
PSRR at Output vs. VP	+4.5 V to +5.5 V			0.5 <sup>1</sup>	%/V
PSRR at Output vs. VN	-4.5 V to -5.5 V			0.5	%/V

<sup>1</sup> All minimum and maximum specifications are guaranteed. These specifications are tested on all production units at final electrical test.

<sup>2</sup>  $T_{MIN} = -40^{\circ}\text{C}$ ,  $T_{MAX} = 85^{\circ}\text{C}$ .

<sup>3</sup> Normalized to zero at  $25^{\circ}\text{C}$ .

<sup>4</sup> Linearity is defined as residual error after compensating for input offset, output voltage offset, and scale factor errors.

## ABSOLUTE MAXIMUM RATINGS

Table 2.

Parameter	Rating
Supply Voltage	$\pm 6$ V
Internal Power Dissipation	300 mW
Operating Temperature Range	$-40^{\circ}\text{C}$ to $+85^{\circ}\text{C}$
Storage Temperature Range	$-65^{\circ}\text{C}$ to $+150^{\circ}\text{C}$
Lead Temperature, Soldering 60 sec	$300^{\circ}\text{C}$
ESD Rating	
HBM	1500 V
CDM	250 V

Stresses above those listed under Absolute Maximum Ratings may cause permanent damage to the device. This is a stress rating only; functional operation of the device at these or any other conditions above those indicated in the operational section of this specification is not implied. Exposure to absolute maximum rating conditions for extended periods may affect device reliability.

For more information, see the Analog Devices, Inc., [Tutorial MT-092, Electrostatic Discharge](#).

## THERMAL RESISTANCE

Table 3.

Package Type	$\theta_{JA}$	$\theta_{JC}$	Unit
8-Lead PDIP (N)	90	35	$^{\circ}\text{C}/\text{W}$
8-Lead SOIC (R)	115	45	$^{\circ}\text{C}/\text{W}$

## ESD CAUTION



**ESD (electrostatic discharge) sensitive device.** Charged devices and circuit boards can discharge without detection. Although this product features patented or proprietary protection circuitry, damage may occur on devices subjected to high energy ESD. Therefore, proper ESD precautions should be taken to avoid performance degradation or loss of functionality.

# AD835

## PIN CONFIGURATION AND FUNCTION DESCRIPTIONS



Figure 2. Pin Configuration

Table 4. Pin Function Descriptions

Pin No.	Mnemonic	Description
1	Y1	Noninverting Y Multiplicand Input
2	Y2	Inverting Y Multiplicand Input
3	VN	Negative Supply Voltage
4	Z	Summing Input
5	W	Product
6	VP	Positive Supply Voltage
7	X2	Inverting X Multiplicand Input
8	X1	Noninverting X Multiplicand Input

# TYPICAL PERFORMANCE CHARACTERISTICS

DG DP (NTSC) FIELD = 1 LINE = 18 Wfm → FCC COMPOSITE

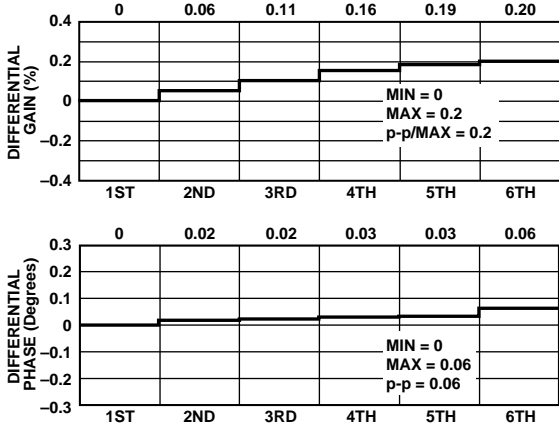

Figure 3. Typical Composite Output Differential Gain and Phase, NTSC for X Channel;  $f = 3.58$  MHz,  $R_L = 150 \Omega$

DG DP (NTSC) FIELD = 1 LINE = 18 Wfm → FCC COMPOSITE

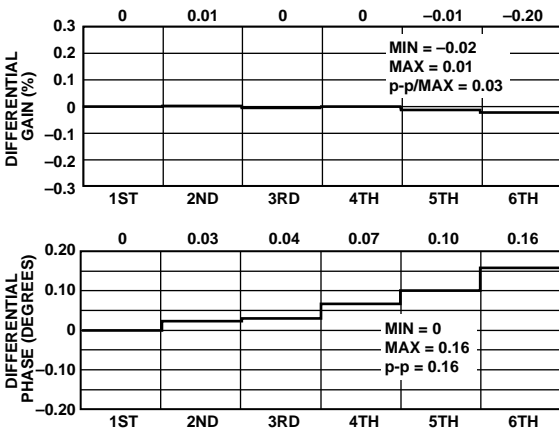

Figure 4. Typical Composite Output Differential Gain and Phase, NTSC for Y Channel;  $f = 3.58$  MHz,  $R_L = 150 \Omega$

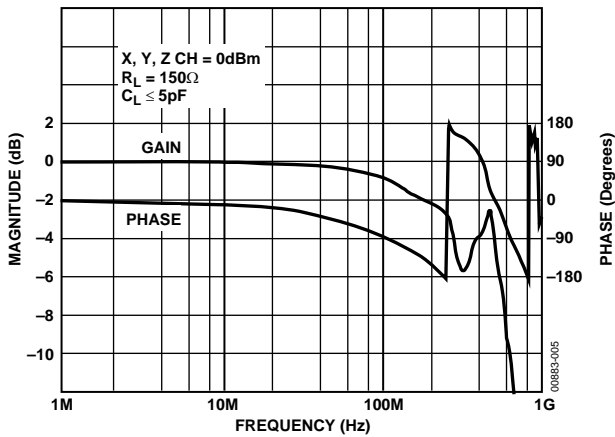

Figure 5. Gain and Phase vs. Frequency of X, Y, Z Inputs

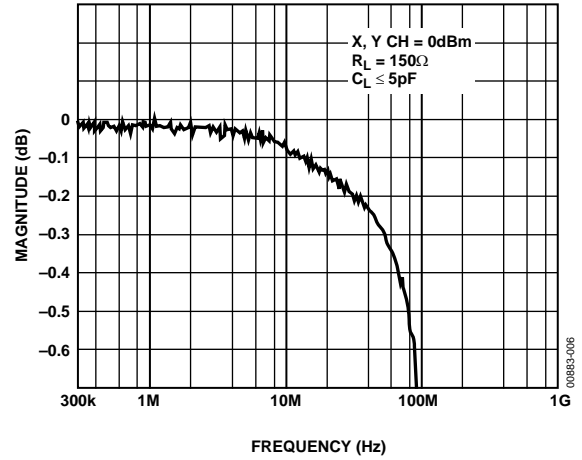

Figure 6. Gain Flatness to 0.1 dB

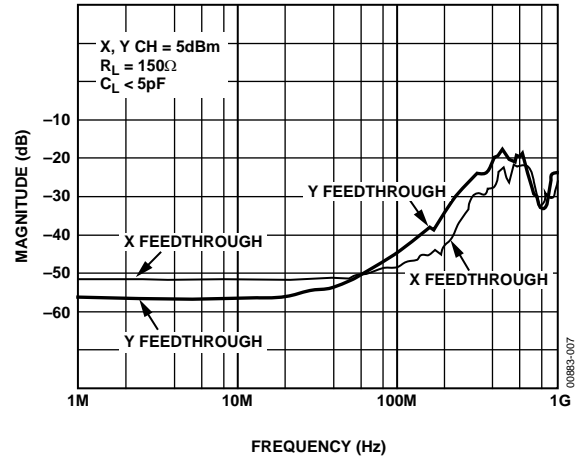

Figure 7. X and Y Feedthrough vs. Frequency

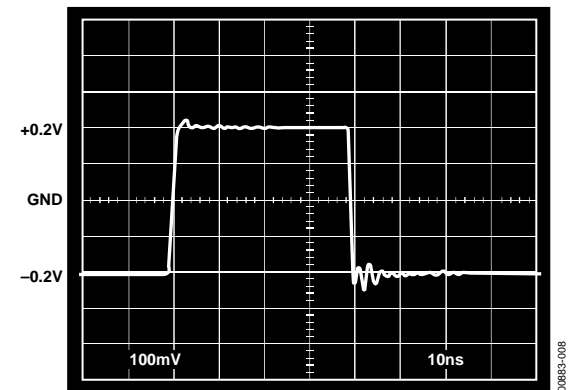

Figure 8. Small Signal Pulse Response at W Output,  $R_L = 150 \Omega$ ,  $C_L \leq 5$  pF, X Channel =  $\pm 0.2$  V, Y Channel =  $\pm 1.0$  V



Figure 9. Large Signal Pulse Response at W Output,  $R_L = 150 \Omega$ ,  $C_L \leq 5 \text{ pF}$ , X Channel =  $\pm 1.0 \text{ V}$ , Y Channel =  $\pm 1.0 \text{ V}$



Figure 12. Harmonic Distortion at 10 MHz; 10 dBm Input to X or Y Channels,  $R_L = 150 \Omega$ ,  $C_L \leq 5 \text{ pF}$

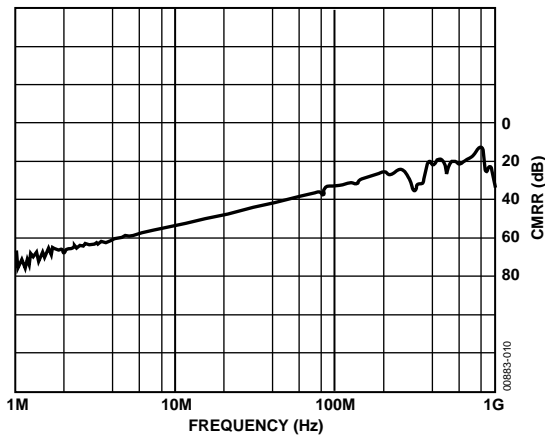

Figure 10. CMRR vs. Frequency for X or Y Channel,  $R_L = 150 \Omega$ ,  $C_L \leq 5 \text{ pF}$



Figure 13. Harmonic Distortion at 50 MHz, 10 dBm Input to X or Y Channel,  $R_L = 150 \Omega$ ,  $C_L \leq 5 \text{ pF}$

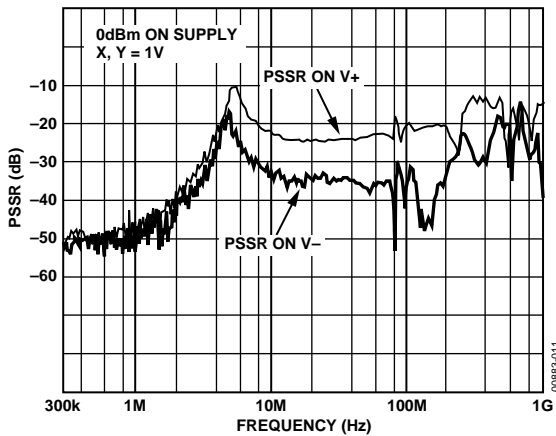

Figure 11. PSRR vs. Frequency for V+ and V- Supply



Figure 14. Harmonic Distortion at 100 MHz, 10 dBm Input to X or Y Channel,  $R_L = 150 \Omega$ ,  $C_L \leq 5 \text{ pF}$





Figure 15. Maximum Output Voltage Swing,  $R_L = 50\ \Omega$ ,  $C_L \leq 5\ \text{pF}$

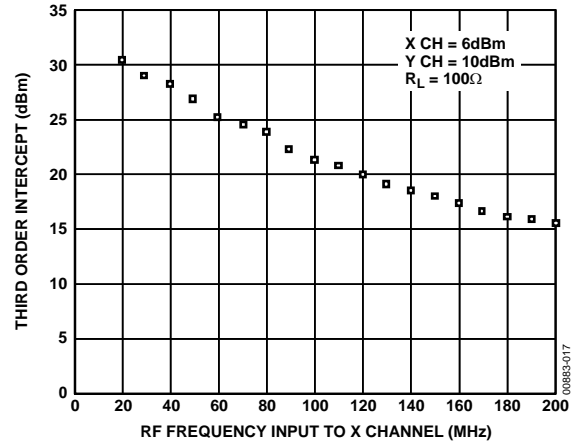

Figure 17. Fixed LO on Y Channel vs. RF Frequency Input to X Channel



Figure 16.  $V_{OS}$  Output Drift vs. Temperature

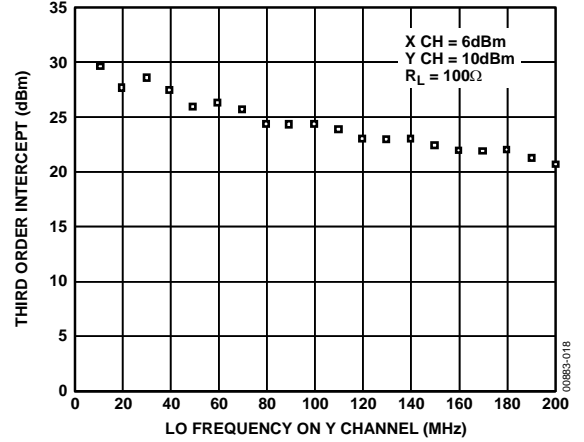

Figure 18. Fixed IF vs. LO Frequency on Y Channel

## THEORY OF OPERATION

The AD835 is a four-quadrant, voltage output analog multiplier, fabricated on an advanced dielectrically isolated complementary bipolar process. In its basic mode, it provides the linear product of its X and Y voltage inputs. In this mode, the -3 dB output voltage bandwidth is 250 MHz (with small signal rise time of 1 ns). Full-scale (-1 V to +1 V) rise to fall times are 2.5 ns (with a standard  $R_L$  of 150  $\Omega$ ), and the settling time to 0.1% under the same conditions is typically 20 ns.

As in earlier multipliers from Analog Devices a unique summing feature is provided at the Z input. As well as providing independent ground references for the input and the output and enhanced versatility, this feature allows the AD835 to operate with voltage gain. Its X-, Y-, and Z-input voltages are all nominally  $\pm 1$  V FS, with an overrange of at least 20%. The inputs are fully differential at high impedance (100 k $\Omega$ ||2 pF) and provide a 70 dB CMRR ( $f \leq 1$  MHz).

The low impedance output is capable of driving loads as small as 25  $\Omega$ . The peak output can be as large as  $\pm 2.2$  V minimum for  $R_L = 150 \Omega$ , or  $\pm 2.0$  V minimum into  $R_L = 50 \Omega$ . The AD835 has much lower noise than the AD534 or AD734, making it attractive in low level, signal processing applications, for example, as a wideband gain control element or modulator.

### BASIC THEORY

The multiplier is based on a classic form, having a translinear core, supported by three (X, Y, and Z) linearized voltage-to-current converters, and the load driving output amplifier. The scaling voltage (the denominator U in the equations) is provided by a band gap reference of novel design, optimized for ultralow noise. Figure 19 shows the functional block diagram.

In general terms, the AD835 provides the function

$$W = \frac{(X_1 - X_2)(Y_1 - Y_2)}{U} + Z \quad (1)$$

where the variables W, U, X, Y, and Z are all voltages. Connected as a simple multiplier, with  $X = X_1 - X_2$ ,  $Y = Y_1 - Y_2$ , and  $Z = 0$  and with a scale factor adjustment (see Figure 19) that sets  $U = 1$  V, the output can be expressed as

$$W = XY \quad (2)$$



Figure 19. Functional Block Diagram

Simplified representations of this sort, where all signals are presumed expressed in V, are used throughout this data sheet to

avoid the needless use of less intuitive subscripted variables (such as,  $V_{X1}$ ). All variables are being normalized to 1 V.

For example, the input X can either be stated as being in the -1 V to +1 V range or simply -1 to +1. The latter representation is found to facilitate the development of new functions using the AD835. The explicit inclusion of the denominator, U, is also less helpful, as in the case of the AD835, if it is not an electrical input variable.

### SCALING ADJUSTMENT

The basic value of U in Equation 1 is nominally 1.05 V. Figure 20, which shows the basic multiplier connections, also shows how the effective value of U can be adjusted to have any lower voltage (usually 1 V) through the use of a resistive divider between W (Pin 5) and Z (Pin 4). Using the general resistor values shown, Equation 1 can be rewritten as

$$W = \frac{XY}{U} + kW + (1 - k)Z' \quad (3)$$

where  $Z'$  is distinguished from the signal Z at Pin 4. It follows that

$$W = \frac{XY}{(1 - k)U} + Z' \quad (4)$$

In this way, the effective value of U can be modified to

$$U' = (1 - k)U \quad (5)$$

without altering the scaling of the  $Z'$  input, which is expected because the only ground reference for the output is through the  $Z'$  input.

Therefore, to set  $U'$  to 1 V, remembering that the basic value of U is 1.05 V,  $R_1$  must have a nominal value of  $20 \times R_2$ . The values shown allow U to be adjusted through the nominal range of 0.95 V to 1.05 V. That is,  $R_2$  provides a 5% gain adjustment.

In many applications, the exact gain of the multiplier may not be very important; in which case, this network may be omitted entirely, or  $R_2$  fixed at 100  $\Omega$ .

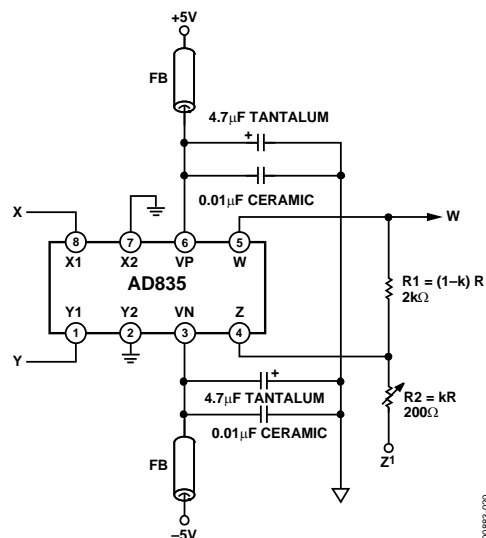

Figure 20. Multiplier Connections

## APPLICATIONS INFORMATION

The AD835 is easy to use and versatile. The capability for adding another signal to the output at the Z input is frequently valuable. Three applications of this feature are presented here: a wideband voltage-controlled amplifier, an amplitude modulator, and a frequency doubler. Of course, the AD835 may also be used as a square law detector (with its X inputs and Y inputs connected in parallel). In this mode, it is useful at input frequencies to well over 250 MHz because that is the bandwidth limitation of the output amplifier only.

### MULTIPLIER CONNECTIONS

Figure 20 shows the basic connections for multiplication. The inputs are often single sided, in which case the X2 and Y2 inputs are normally grounded. Note that by assigning Pin 7 (X2) and Pin 2 (Y2), respectively, to these (inverting) inputs, an extra measure of isolation between inputs and output is provided. The X and Y inputs may be reversed to achieve some desired overall sign with inputs of a particular polarity, or they may be driven fully differentially.

Power supply decoupling and careful board layout are always important in applying wideband circuits. The decoupling recommendations shown in Figure 20 should be followed closely. In Figure 21, Figure 23, and Figure 24, these power supply decoupling components are omitted for clarity but should be used wherever optimal performance with high speed inputs is required. However, if the full, high frequency capabilities of the AD835 are not being exploited, these components can be omitted.

### WIDEBAND VOLTAGE-CONTROLLED AMPLIFIER

Figure 21 shows the AD835 configured to provide a gain of nominally 0 dB to 12 dB. (In fact, the control range extends from well under -12 dB to about +14 dB.) R1 and R2 set the gain to be nominally  $\times 4$ . The attendant bandwidth reduction that comes with this increased gain can be partially offset by the addition of the peaking capacitor C1. Although this circuit shows the use of dual supplies, the AD835 can operate from a single 9 V supply with a slight revision.



Figure 21. Voltage-Controlled 50 MHz Amplifier Using the AD835

The ac response of this amplifier for gains of 0 dB ( $V_G = 0.25$  V), 6 dB ( $V_G = 0.5$  V), and 12 dB ( $V_G = 1$  V) is shown in Figure 22. In this application, the resistor values have been slightly adjusted to reflect the nominal value of  $U = 1.05$  V. The overall sign of the gain may be controlled by the sign of  $V_G$ .



Figure 22. AC Response of VCA

### AMPLITUDE MODULATOR

Figure 23 shows a simple modulator. The carrier is applied to the Y input and the Z input, while the modulating signal is applied to the X input. For zero modulation, there is no product term so the carrier input is simply replicated at unity gain by the voltage follower action from the Z input. At  $X = 1$  V, the RF output is doubled, while for  $X = -1$  V, it is fully suppressed. That is, an X input of approximately  $\pm 1$  V (actually  $\pm U$  or about 1.05 V) corresponds to a modulation index of 100%. Carrier and modulation frequencies can be up to 300 MHz, somewhat beyond the nominal -3 dB bandwidth.

Of course, a suppressed carrier modulator can be implemented by omitting the feedforward to the Z input, grounding that pin instead.

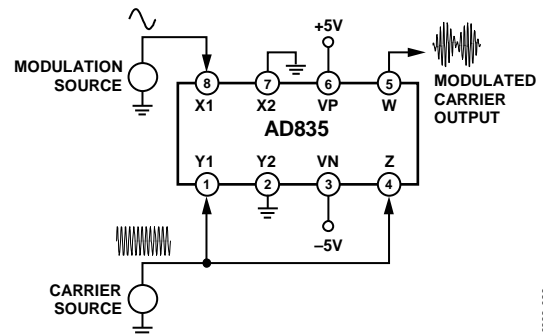

Figure 23. Simple Amplitude Modulator Using the AD835

## SQUARING AND FREQUENCY DOUBLING

Amplitude domain squaring of an input signal,  $E$ , is achieved simply by connecting the X and Y inputs in parallel to produce an output of  $E^2/U$ . The input can have either polarity, but the output in this case is always positive. The output polarity can be reversed by interchanging either the X or Y inputs.

When the input is a sine wave  $E \sin \omega t$ , a signal squarer behaves as a frequency doubler because

$$\frac{(E \sin \omega t)^2}{U} = \frac{E^2}{2U} (1 - \cos 2\omega t) \quad (6)$$

While useful, Equation 6 shows a dc term at the output, which varies strongly with the amplitude of the input,  $E$ .

Figure 24 shows a frequency doubler that overcomes this limitation and provides a relatively constant output over a moderately wide frequency range, determined by the time constant  $R1C1$ . The voltage applied to the X and Y inputs is exactly in quadrature at a frequency  $f = \frac{1}{2}\pi C1R1$ , and their amplitudes are equal. At higher frequencies, the X input becomes smaller while the Y input increases in amplitude; the opposite happens at lower frequencies. The result is a double frequency output centered on ground whose amplitude of 1 V for a 1 V input varies by only 0.5% over a frequency range of  $\pm 10\%$ . Because there is no squared dc component at the output, sudden changes in the input amplitude do not cause a bounce in the dc level.



Figure 24. Broadband Zero-Bounce Frequency Doubler

This circuit is based on the identity

$$\cos \theta \sin \theta = \frac{1}{2} \sin 2\theta \quad (7)$$

At  $\omega_0 = 1/C1R1$ , the X input leads the input signal by  $45^\circ$  (and is attenuated by  $\sqrt{2}$ ), while the Y input lags the input signal by  $45^\circ$  and is also attenuated by  $\sqrt{2}$ . Because the X and Y inputs are  $90^\circ$  out of phase, the response of the circuit is

$$W = \frac{1}{U} \frac{E}{\sqrt{2}} (\sin \omega t - 45^\circ) \frac{E}{\sqrt{2}} (\sin \omega t + 45^\circ) = \frac{E^2}{2U} (\sin 2\omega t) \quad (8)$$

which has no dc component,  $R2$  and  $R3$  are included to restore the output to 1 V for an input amplitude of 1 V (the same gain adjustment as previously mentioned). Because the voltage across the capacitor ( $C1$ ) decreases with frequency, while that across the resistor ( $R1$ ) increases, the amplitude of the output varies only slightly with frequency. In fact, it is only 0.5% below its full value (at its center frequency  $\omega_0 = 1/C1R1$ ) at 90% and 110% of this frequency.

OUTLINE DIMENSIONS

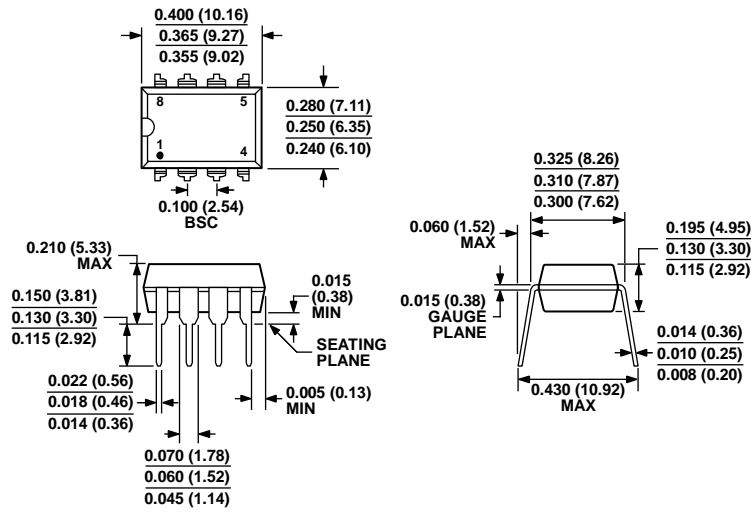

COMPLIANT TO JEDEC STANDARDS MS-001  
 CONTROLLING DIMENSIONS ARE IN INCHES; MILLIMETER DIMENSIONS (IN PARENTHESES) ARE ROUNDED-OFF INCH EQUIVALENTS FOR REFERENCE ONLY AND ARE NOT APPROPRIATE FOR USE IN DESIGN. CORNER LEADS MAY BE CONFIGURED AS WHOLE OR HALF LEADS.

Figure 25. 8-Lead Plastic Dual In-Line Package [PDIP] Narrow Body (N-8)

Dimensions shown in inches and (millimeters)

070606-A

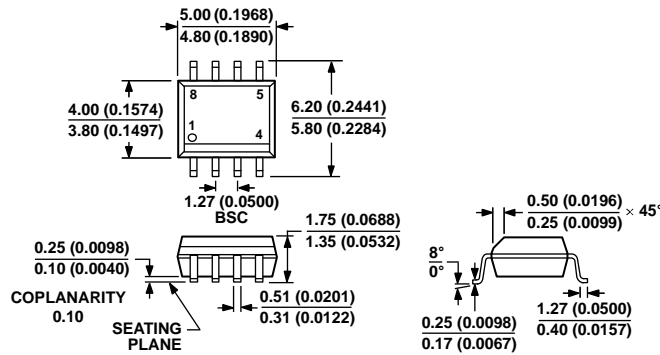

COMPLIANT TO JEDEC STANDARDS MS-012-AA  
 CONTROLLING DIMENSIONS ARE IN MILLIMETERS; INCH DIMENSIONS (IN PARENTHESES) ARE ROUNDED-OFF MILLIMETER EQUIVALENTS FOR REFERENCE ONLY AND ARE NOT APPROPRIATE FOR USE IN DESIGN.

Figure 26. 8-Lead Standard Small Outline Package [SOIC\_N] Narrow Body (R-8)

Dimensions shown in millimeters and (inches)

012407-A

# AD835

## ORDERING GUIDE

Model <sup>1</sup>	Temperature Range	Package Description	Package Option
AD835AN	-40°C to +85°C	8-Lead Plastic Dual In-Line Package [PDIP]	N-8
AD835ANZ	-40°C to +85°C	8-Lead Plastic Dual In-Line Package [PDIP]	N-8
AD835AR	-40°C to +85°C	8-Lead Standard Small Outline Package [SOIC_N]	R-8
AD835AR-REEL	-40°C to +85°C	8-Lead Standard Small Outline Package [SOIC_N]	R-8
AD835AR-REEL7	-40°C to +85°C	8-Lead Standard Small Outline Package [SOIC_N]	R-8
AD835ARZ	-40°C to +85°C	8-Lead Standard Small Outline Package [SOIC_N]	R-8
AD835ARZ-REEL	-40°C to +85°C	8-Lead Standard Small Outline Package [SOIC_N]	R-8
AD835ARZ-REEL7	-40°C to +85°C	8-Lead Standard Small Outline Package [SOIC_N]	R-8

<sup>1</sup> Z = RoHS Compliant Part.

**NOTES**

**AD835**

**NOTES**





## Стандарт Электрон Связь

Мы молодая и активно развивающаяся компания в области поставок электронных компонентов. Мы поставляем электронные компоненты отечественного и импортного производства напрямую от производителей и с крупнейших складов мира.

Благодаря сотрудничеству с мировыми поставщиками мы осуществляем комплексные и плановые поставки широчайшего спектра электронных компонентов.

Собственная эффективная логистика и склад в обеспечивает надежную поставку продукции в точно указанные сроки по всей России.

Мы осуществляем техническую поддержку нашим клиентам и предпродажную проверку качества продукции. На все поставляемые продукты мы предоставляем гарантию .

Осуществляем поставки продукции под контролем ВП МО РФ на предприятия военно-промышленного комплекса России , а также работаем в рамках 275 ФЗ с открытием отдельных счетов в уполномоченном банке. Система менеджмента качества компании соответствует требованиям ГОСТ ISO 9001.

Минимальные сроки поставки, гибкие цены, неограниченный ассортимент и индивидуальный подход к клиентам являются основой для выстраивания долгосрочного и эффективного сотрудничества с предприятиями радиоэлектронной промышленности, предприятиями ВПК и научно-исследовательскими институтами России.

С нами вы становитесь еще успешнее!

### Наши контакты:

**Телефон:** +7 812 627 14 35

**Электронная почта:** [sales@st-electron.ru](mailto:sales@st-electron.ru)

**Адрес:** 198099, Санкт-Петербург,  
Промышленная ул, дом № 19, литера Н,  
помещение 100-Н Офис 331