

Part Number: WP119SURKMGKWT

Hyper Red  
Mega Green

### Features

- UNIFORM LIGHT OUTPUT.
- LOW POWER CONSUMPTION.
- 3 LEADS WITH ONE COMMON LEAD.
- I.C. COMPATIBLE.
- LONG LIFE - SOLID STATE RELIABILITY.
- RoHS COMPLIANT.

### Description

The Hyper Red source color devices are made with DH InGaAlP on GaAs substrate Light Emitting Diode.  
The Mega Green source color devices are made with DH InGaAlP on GaAs substrate Light Emitting Diode.

### Package Dimensions

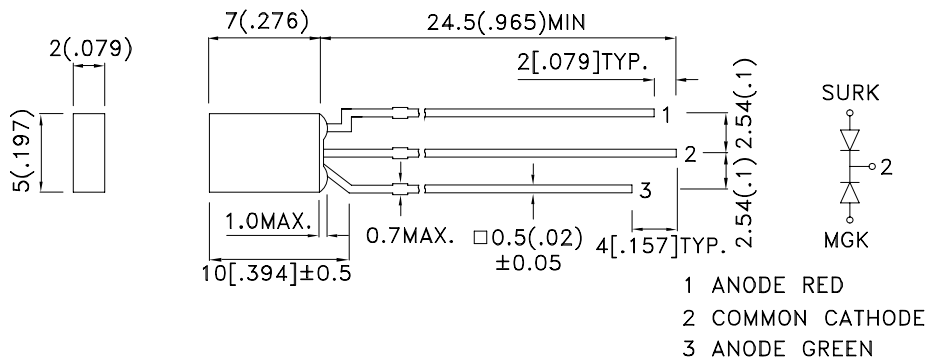

#### Notes:

1. All dimensions are in millimeters (inches).
2. Tolerance is  $\pm 0.25(0.01)$ " unless otherwise noted.
3. Lead spacing is measured where the leads emerge from the package.
4. Specifications are subject to change without notice



## Selection Guide

| Part No.       | Dice                 | Lens Type      | Iv (mcd) [2]<br>@ 20mA |      | Viewing<br>Angle [1] |
|----------------|----------------------|----------------|------------------------|------|----------------------|
|                |                      |                | Min.                   | Typ. | 2θ1/2                |
| WP119SURKMGKWT | Hyper Red (InGaAlP)  | WHITE DIFFUSED | 70                     | 170  | 110°                 |
|                | Mega Green (InGaAlP) |                | 10                     | 30   |                      |

Notes:

- θ1/2 is the angle from optical centerline where the luminous intensity is 1/2 the optical centerline value.
- Luminous intensity/ luminous Flux: +/-15%.

## Electrical / Optical Characteristics at TA=25°C

| Symbol                | Parameter                | Device                  | Typ.        | Max.       | Units | Test Conditions           |
|-----------------------|--------------------------|-------------------------|-------------|------------|-------|---------------------------|
| $\lambda_{peak}$      | Peak Wavelength          | Hyper Red<br>Mega Green | 650<br>574  |            | nm    | I <sub>F</sub> =20mA      |
| $\lambda_D$ [1]       | Dominant Wavelength      | Hyper Red<br>Mega Green | 635<br>570  |            | nm    | I <sub>F</sub> =20mA      |
| $\Delta\lambda_{1/2}$ | Spectral Line Half-width | Hyper Red<br>Mega Green | 28<br>20    |            | nm    | I <sub>F</sub> =20mA      |
| C                     | Capacitance              | Hyper Red<br>Mega Green | 35<br>15    |            | pF    | V <sub>F</sub> =0V;f=1MHz |
| V <sub>F</sub> [2]    | Forward Voltage          | Hyper Red<br>Mega Green | 1.95<br>2.1 | 2.5<br>2.5 | V     | I <sub>F</sub> =20mA      |
| I <sub>R</sub>        | Reverse Current          | Hyper Red<br>Mega Green |             | 10<br>10   | uA    | V <sub>R</sub> = 5V       |

Notes:

- Wavelength: +/-1nm.
- Forward Voltage: +/-0.1V.

## Absolute Maximum Ratings at TA=25°C

| Parameter                       | Hyper Red           | Mega Green | Units |
|---------------------------------|---------------------|------------|-------|
| Power dissipation               | 75                  | 75         | mW    |
| DC Forward Current              | 30                  | 30         | mA    |
| Peak Forward Current [1]        | 185                 | 150        | mA    |
| Reverse Voltage                 | 5                   |            | V     |
| Operating / Storage Temperature | -40°C To +85°C      |            |       |
| Lead Solder Temperature [2]     | 260°C For 3 Seconds |            |       |
| Lead Solder Temperature [3]     | 260°C For 5 Seconds |            |       |

Notes:

- 1/10 Duty Cycle, 0.1ms Pulse Width.
- 2mm below package base.
- 5mm below package base.

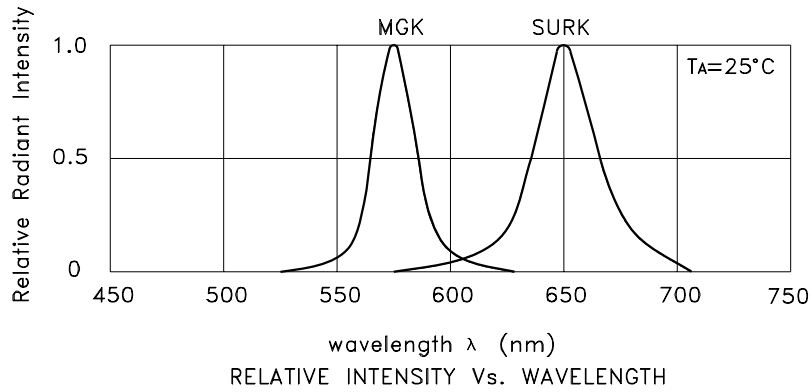

## WP119SURKMGKWT Hyper Red

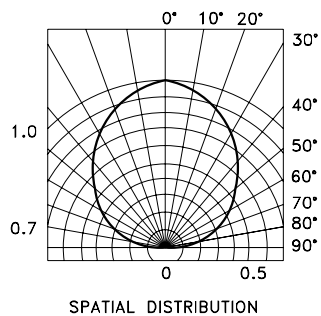
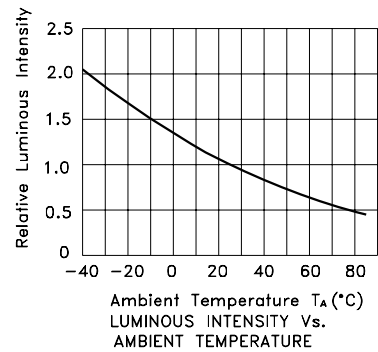
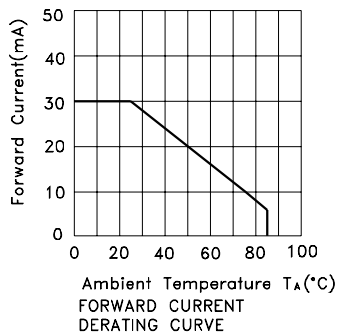
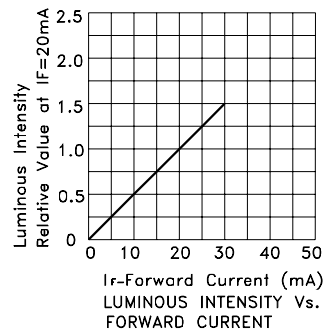
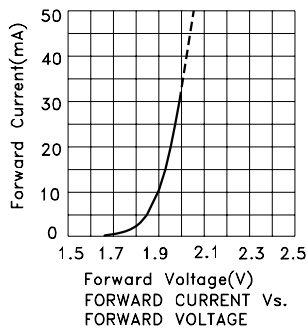

# Kingbright

## Mega Green

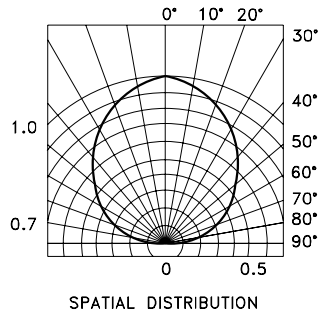
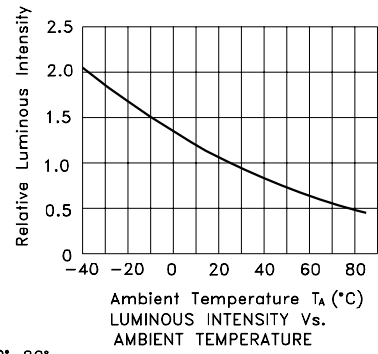
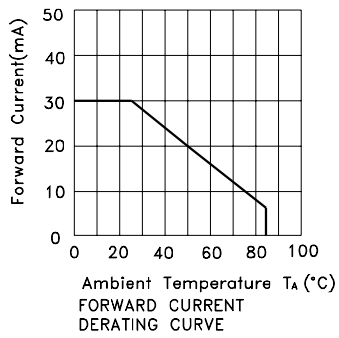
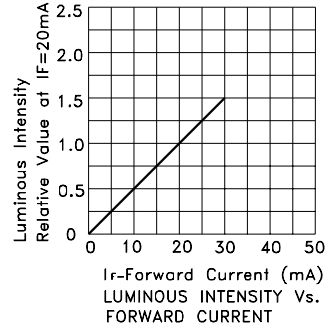
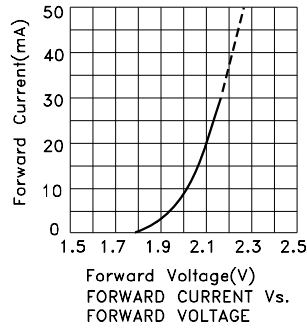

# Kingbright

## PACKING & LABEL SPECIFICATIONS

WP119SURKMGKWT

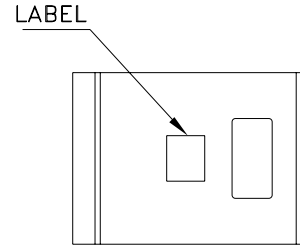
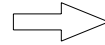
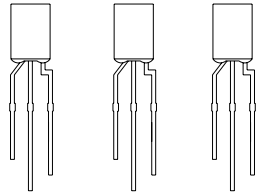

500PCS / BAG



20K / 9# BOX

OUTSIDE LABEL

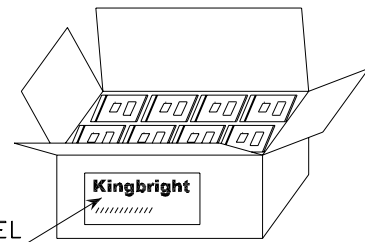
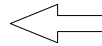

10K / 5# BOX

OUTSIDE LABEL

|  |                          |
|--|--------------------------|
| <h1>Kingbright</h1>  |                          |
| Q.C.   | QC<br>XX XX XX<br>PASSED |
| TYPE NO : WP119xxx   |                          |
| QUANTITY : 500 pcs   |                          |
| S/N : XX   | CODE: XX                 |
| LOT NO : <br>xxxxxxxxxx |                          |
| RoHS Compliant   |                          |

## LED MOUNTING METHOD

1. The lead pitch of the LED must match the pitch of the mounting holes on the PCB during component placement. Lead-forming may be required to insure the lead pitch matches the hole pitch. Refer to the figure below for proper lead forming procedures.

(Fig. 1)

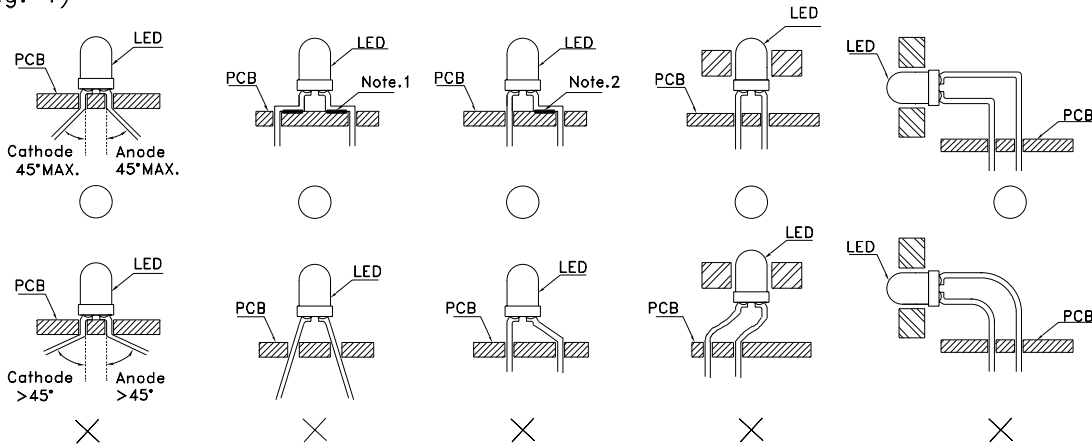

Fig.1

”O” Correct mounting method ”X” Incorrect mounting method

Note 1-2 : Do not route PCB trace in the contact area between the leadframe and the PCB to prevent short-circuits.

2. When soldering wire to the LED, use individual heat-shrink tubing to insulate the exposed leads to prevent accidental contact short-circuit.

(Fig. 2)



Fig. 2

3. Use stand-offs (Fig. 3) or spacers (Fig. 4) to securely position the LED above the PCB.

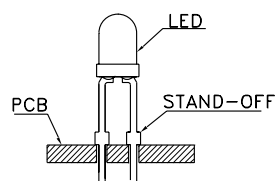

Fig. 3

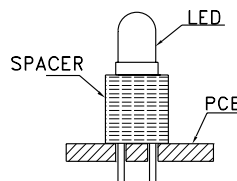

Fig. 4

## LEAD FORMING PROCEDURES

1. Maintain a minimum of 2mm clearance between the base of the LED lens and the first lead bend. (Fig. 5 and 6)



Fig. 5



Fig. 6

2. Lead forming or bending must be performed before soldering, never during or after Soldering.
3. Do not stress the LED lens during lead-forming in order to fractures in the lens epoxy and damage the internal structures.
4. During lead forming, use tools or jigs to hold the leads securely so that the bending force will not be transmitted to the LED lens and its internal structures. Do not perform lead forming once the component has been mounted onto the PCB. (Fig. 7)
5. Do not bend the leads more than twice. (Fig. 8)



Fig. 7



Fig. 8

6. After soldering or other high-temperature assembly, allow the LED to cool down to 50°C before applying outside force (Fig. 9). In general, avoid placing excess force on the LED to avoid damage. For any questions please consult with Kingbright representative for proper handling procedures.

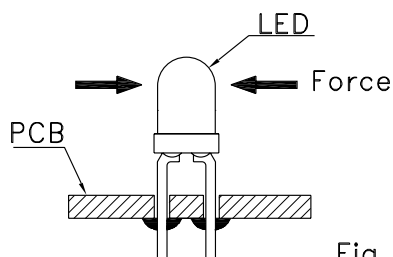

Fig. 9



## Стандарт Электрон Связь

Мы молодая и активно развивающаяся компания в области поставок электронных компонентов. Мы поставляем электронные компоненты отечественного и импортного производства напрямую от производителей и с крупнейших складов мира.

Благодаря сотрудничеству с мировыми поставщиками мы осуществляем комплексные и плановые поставки широчайшего спектра электронных компонентов.

Собственная эффективная логистика и склад в обеспечивает надежную поставку продукции в точно указанные сроки по всей России.

Мы осуществляем техническую поддержку нашим клиентам и предпродажную проверку качества продукции. На все поставляемые продукты мы предоставляем гарантию .

Осуществляем поставки продукции под контролем ВП МО РФ на предприятия военно-промышленного комплекса России , а также работаем в рамках 275 ФЗ с открытием отдельных счетов в уполномоченном банке. Система менеджмента качества компании соответствует требованиям ГОСТ ISO 9001.

Минимальные сроки поставки, гибкие цены, неограниченный ассортимент и индивидуальный подход к клиентам являются основой для выстраивания долгосрочного и эффективного сотрудничества с предприятиями радиоэлектронной промышленности, предприятиями ВПК и научно-исследовательскими институтами России.

С нами вы становитесь еще успешнее!

### Наши контакты:

**Телефон:** +7 812 627 14 35

**Электронная почта:** [sales@st-electron.ru](mailto:sales@st-electron.ru)

**Адрес:** 198099, Санкт-Петербург,  
Промышленная ул, дом № 19, литера Н,  
помещение 100-Н Офис 331