

"Half-Bridge" IGBT INT-A-PAK (Ultrafast Speed IGBT), 75 A



INT-A-PAK

FEATURES

- Generation 4 IGBT technology
- Ultrafast: Optimized for high speed 8 kHz to 40 kHz in hard switching, > 200 kHz in resonant mode
- Very low conduction and switching losses
- HEXFRED® antiparallel diodes with ultrasoft recovery
- Industry standard package
- UL approved file E78996 
- Compliant to RoHS directive 2002/95/EC
- Designed and qualified for industrial level

RoHS
COMPLIANT

PRODUCT SUMMARY	
V_{CES}	1200 V
I_C DC	110 A
$V_{CE(on)}$ at 75 A, 25 °C	2.5 V

BENEFITS

- Increased operating efficiency
- Direct mounting to heatsink
- Performance optimized for power conversion: UPS, SMPS, welding
- Lower EMI, requires less snubbing

ABSOLUTE MAXIMUM RATINGS				
PARAMETER	SYMBOL	TEST CONDITIONS	MAX.	UNITS
Collector to emitter voltage	V_{CES}		1200	V
Continuous collector current	I_C	$T_C = 25\text{ °C}$	110	A
		$T_C = 76\text{ °C}$	75	
Pulsed collector current	I_{CM}	Repetitive rating; $V_{GE} = 20\text{ V}$, pulse width limited by maximum junction temperature	150	
Peak switching current See fig. 17	I_{LM}		150	
Peak diode forward current	I_{FM}		150	V
Gate to emitter voltage	V_{GE}		± 20	
RMS isolation voltage	V_{ISOL}	Any terminal to case, $t = 1\text{ minute}$	2500	W
Maximum power dissipation	P_D	$T_C = 25\text{ °C}$	390	
		$T_C = 85\text{ °C}$	200	
Operating junction temperature range	T_J		- 40 to + 150	°C
Storage temperature range	T_{Stg}		- 40 to + 125	

Vishay High Power Products "Half-Bridge" IGBT INT-A-PAK
 (Ultrafast Speed IGBT), 75 A

ELECTRICAL SPECIFICATIONS (T _J = 25 °C unless otherwise specified)						
PARAMETER	SYMBOL	TEST CONDITIONS	MIN.	TYP.	MAX.	UNITS
Collector to emitter breakdown voltage	V _{(BR)CES}	V _{GE} = 0 V, I _C = 1 mA	1200	-	-	V
Collector to emitter voltage	V _{CE(on)}	V _{GE} = 15 V, I _C = 75 A	-	2.5	3.7	
		I _C = 75 A, V _{GE} = 15 V, T _J = 125 °C	-	2.25	3.3	
Gate threshold voltage	V _{GE(th)}	V _{CE} = 6.0 V, I _C = 750 μA	3.0	4.5	6.0	
Temperature coefficient of threshold voltage	ΔV _{GE(th)/ΔT_J}		-	- 14	-	mV/°C
Forward transconductance	g _{fe}	V _{CE} = 25 V, I _C = 75 A Pulse width 50 μs, single shot	-	107	-	S
Collector to emitter leaking current	I _{CES}	V _{GE} = 0 V, V _{CE} = 1200 V	-	0.03	1.0	mA
		V _{GE} = 0 V, V _{CE} = 1200 V, T _J = 125 °C	-	4.3	10	
Diode forward voltage	V _F	V _{GE} = 0 V, I _F = 75 A	-	3	3.6	V
		I _F = 75 A, V _{GE} = 0 V, T _J = 125 °C	-	2.83	3.3	
Gate to emitter leakage current	I _{GES}	V _{GE} = ± 20 V	-	-	250	nA

SWITCHING CHARACTERISTICS (T _J = 25 °C unless otherwise noted)						
PARAMETER	SYMBOL	TEST CONDITIONS	MIN.	TYP.	MAX.	UNITS
Total gate charge (turn-on)	Q _g	V _{CC} = 400 V I _C = 85 A	-	570	854	nC
Gate to emitter charge (turn-on)	Q _{ge}		-	96	144	
Gate to collector charge (turn-on)	Q _{gc}		-	189	283	
Turn-on delay time	t _{d(on)}	R _{g1} = 15 Ω R _{g2} = 0 Ω I _C = 75 A	-	437	-	ns
Rise time	t _r		-	60	-	
Turn-off delay time	t _{d(off)}	V _{CC} = 720 V	-	395	-	
Fall time	t _f		-	245	-	
Turn-on switching energy	E _{on}	V _{GE} = ± 15 V Inductor load T _J = 25 °C	-	5	-	mJ
Turn-off switching energy	E _{off} ⁽¹⁾		-	3	-	
Total switching energy	E _{ts} ⁽¹⁾		-	8	-	
Turn-on delay time	t _{d(on)}	R _{g1} = 15 Ω R _{g2} = 0 Ω I _C = 75 A	-	453	-	ns
Rise time	t _r		-	70	-	
Turn-off delay time	t _{d(off)}	V _{CC} = 720 V	-	415	-	
Fall time	t _f		-	661	-	
Turn-on switching energy	E _{on}	V _{GE} = ± 15 V Inductor load T _J = 125 °C	-	8	-	mJ
Turn-off switching energy	E _{off} ⁽¹⁾		-	11	-	
Total switching energy	E _{ts} ⁽¹⁾		-	19	32	
Input capacitance	C _{ies}	V _{GE} = 0 V	-	12 815	-	pF
Output capacitance	C _{oes}	V _{CC} = 30 V	-	570	-	
Reverse transfer capacitance	C _{res}	f = 1 MHz	-	110	-	
Diode reverse recovery time	t _{rr}	R _{g1} = 15 Ω R _{g2} = 0 Ω I _C = 75 A	-	174	-	ns
Diode peak reverse current	I _{rr}		-	107	-	A
Diode recovery charge	Q _{rr}	V _{CC} = 720 V	-	9367	-	nC
Diode peak rate of fall of recovery during t _b	dl _(rec) /dt		dl/dt = 1300 A/μs	-	1491	-

Note

⁽¹⁾ Repetitive rating; V_{GE} = 20 V, pulse width limited by maximum junction temperature

THERMAL AND MECHANICAL SPECIFICATIONS					
PARAMETER	SYMBOL	TEST CONDITIONS	TYP.	MAX.	UNITS
Thermal resistance, junction to case	R _{thJC}	IGBT	-	0.32	°C/W
		Diode	-	0.35	
Thermal resistance, case to sink per module	R _{thCS}		0.1	-	
Mounting torque		case to heatsink	-	4.0	Nm
		case to terminal 1, 2 and 3	For screws M5 x 0.8	-	
Weight of module			200	-	g

"Half-Bridge" IGBT INT-A-PAK Vishay High Power Products (Ultrafast Speed IGBT), 75 A

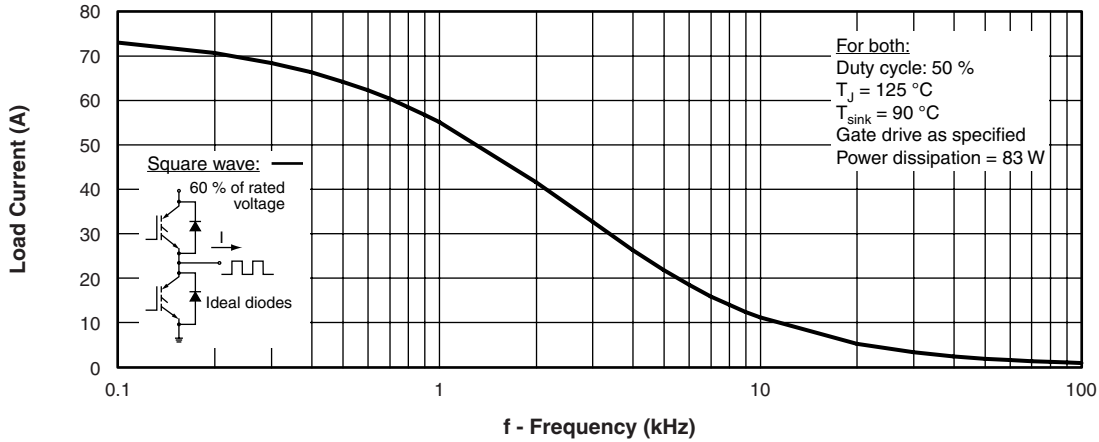

Fig. 1 - Typical Load Current vs. Frequency
(Load Current = I_{RMS} of Fundamental)

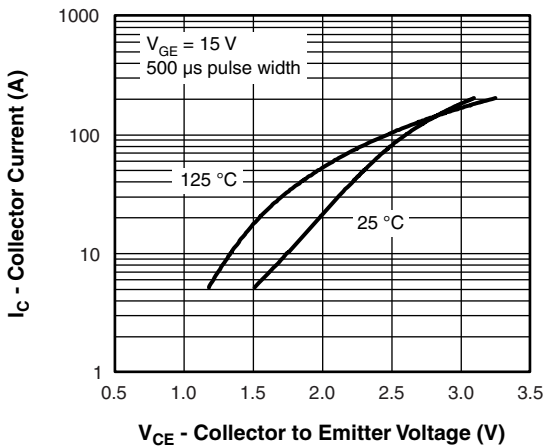

Fig. 2 - Typical Output Characteristics

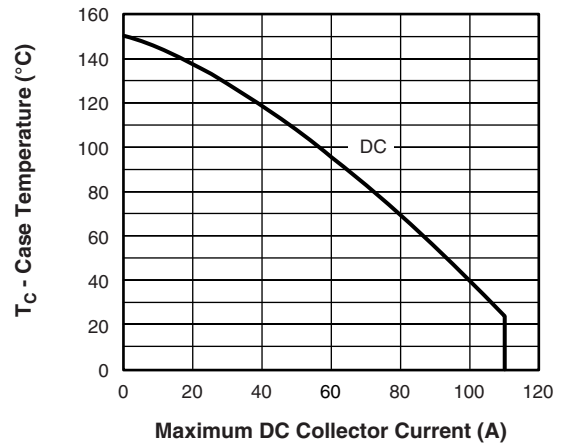

Fig. 4 - Case Temperature vs.
Maximum Collector Current

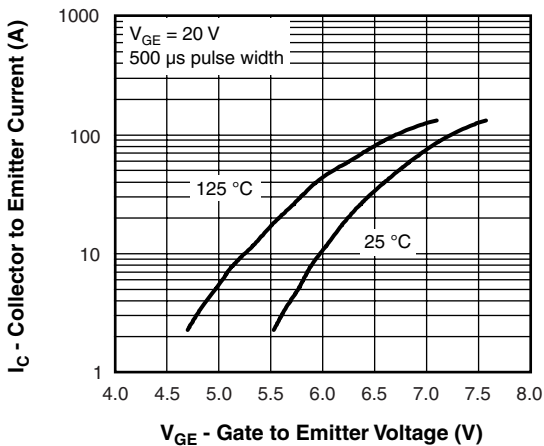

Fig. 3 - Typical Transfer Characteristics

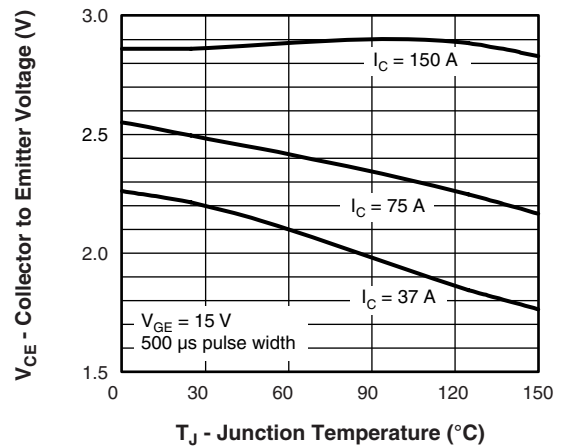

Fig. 5 - Typical Collector to Emitter Voltage vs.
Junction Temperature

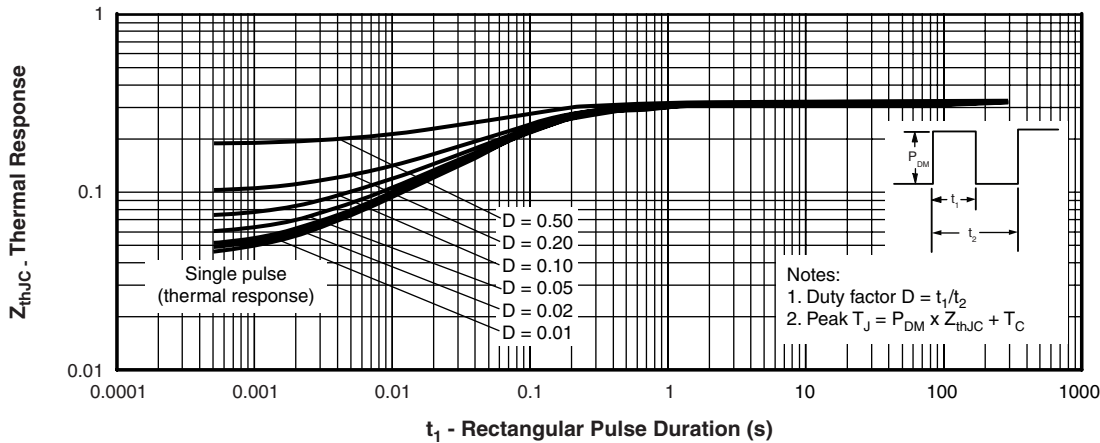

Fig. 6 - Maximum Effective Transient Thermal Impedance, Junction to Case

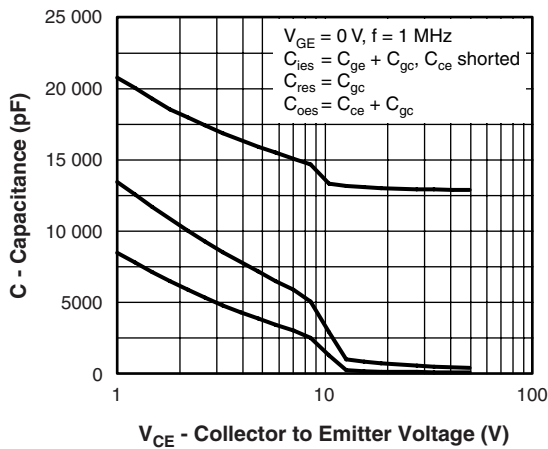

Fig. 7 - Typical Capacitance vs. Collector to Emitter Voltage

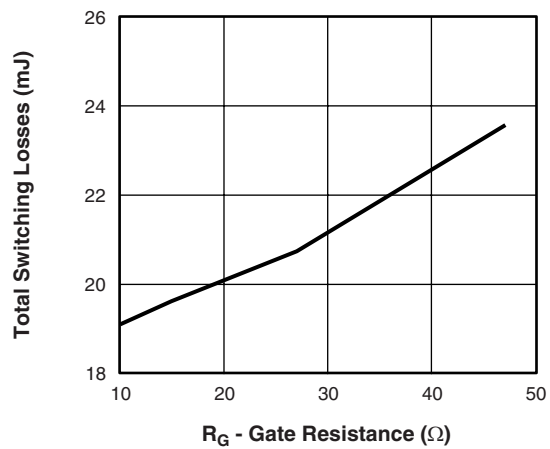

Fig. 9 - Typical Switching Losses vs. Gate Resistance

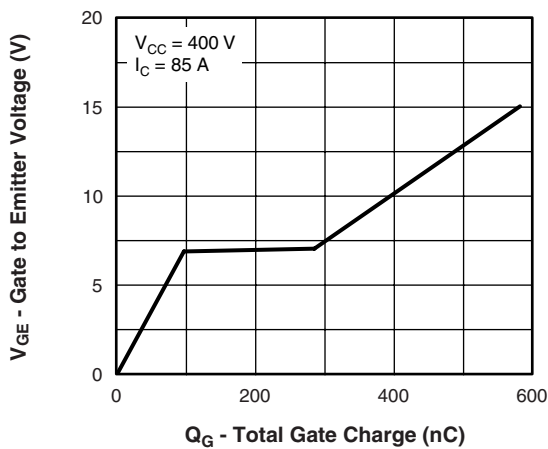

Fig. 8 - Typical Gate Charge vs. Gate to Emitter Voltage

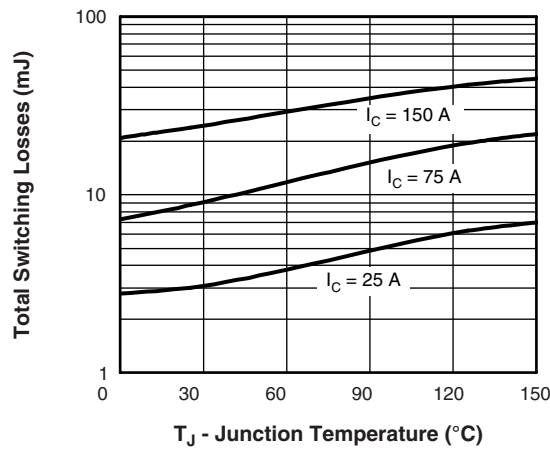

Fig. 10 - Typical Switching Losses vs. Junction Temperature

"Half-Bridge" IGBT INT-A-PAK Vishay High Power Products
(Ultrafast Speed IGBT), 75 A

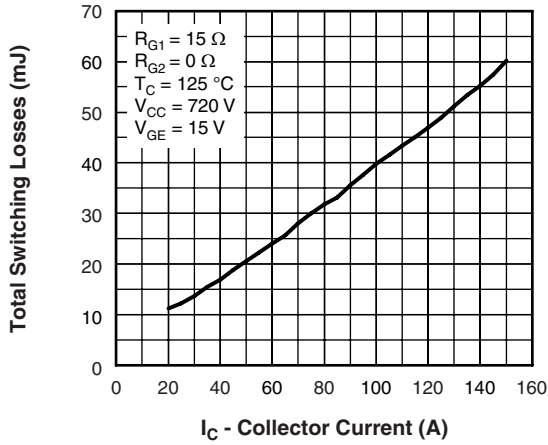

Fig. 11 - Typical Switching Losses vs. Collector to Emitter Current

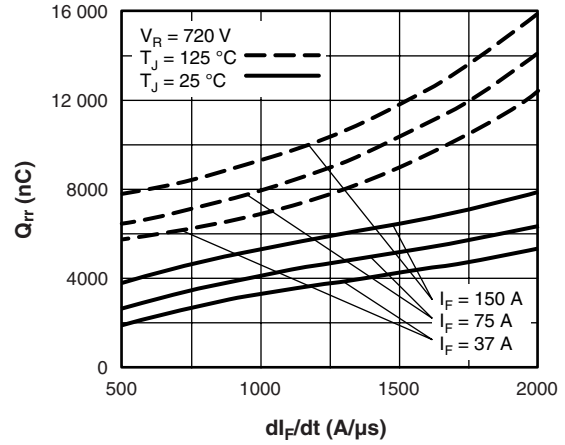

Fig. 14 - Typical Stored Charge vs. di_F/dt

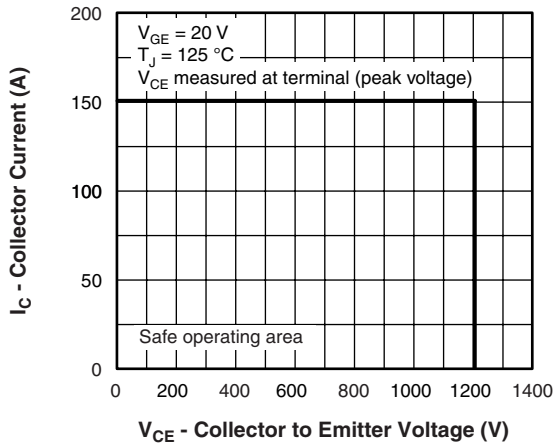

Fig. 12 - Reverse Bias SOA

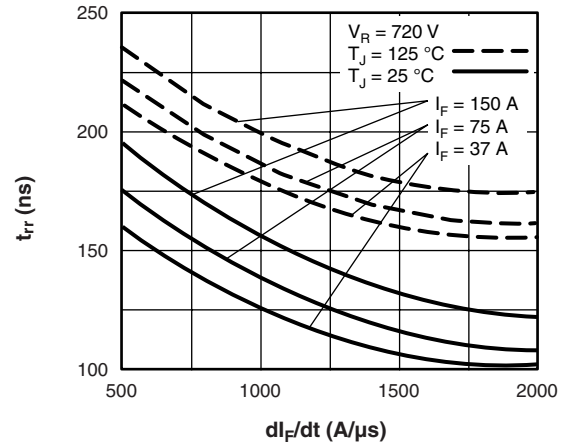

Fig. 15 - Typical Reverse Recovery Time vs. di_F/dt

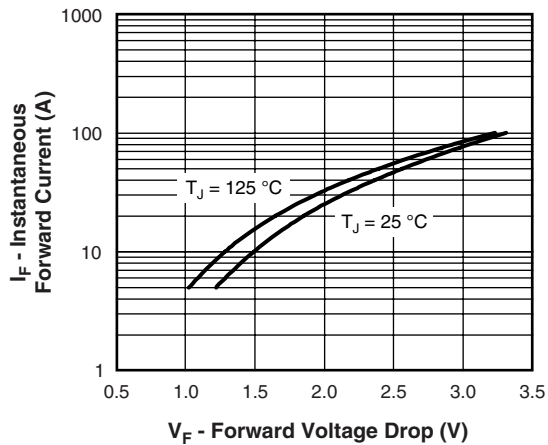

Fig. 13 - Typical Forward Voltage Drop vs. Instantaneous Forward Current

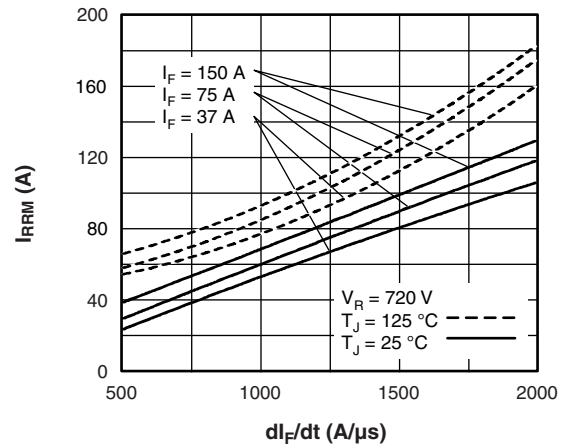

Fig. 16 - Typical Recovery Current vs. di_F/dt

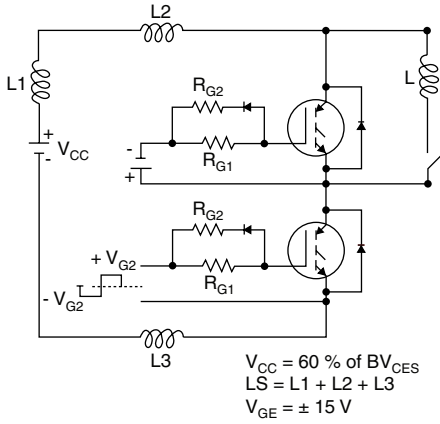

Fig. 17a - Test Circuit for Measurement of I_{LM} , E_{on} , $E_{off}(\text{diode})$, t_{rr} , Q_{rr} , I_{rr} , $t_{d(on)}$, t_r , $t_{d(off)}$, t_f

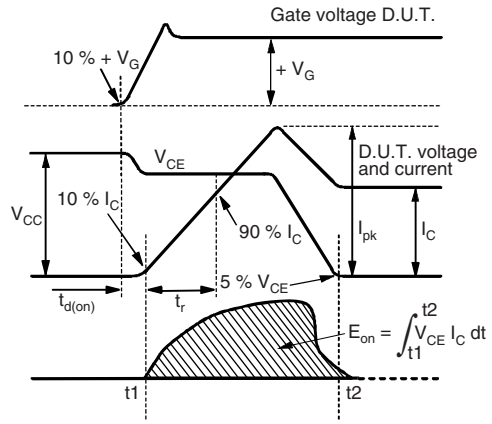

Fig. 17c - Test Waveforms for Circuit of Fig. 18a, Defining E_{on} , $t_{d(on)}$, t_r

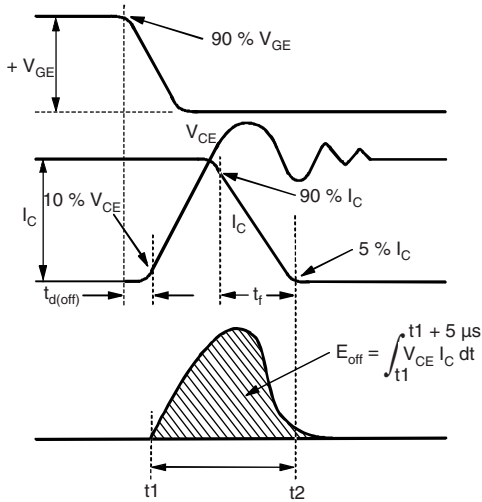

Fig. 17b - Test Waveforms for Circuit of Fig. 18a, Defining E_{off} , $t_{d(off)}$, t_f

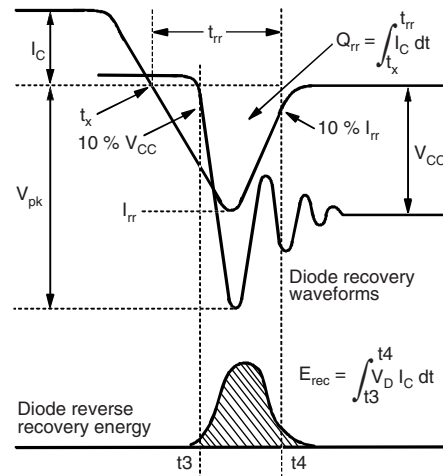

Fig. 17d - Test Waveforms for Circuit of Fig. 18a, Defining E_{rec} , t_{rr} , Q_{rr} , I_{rr}

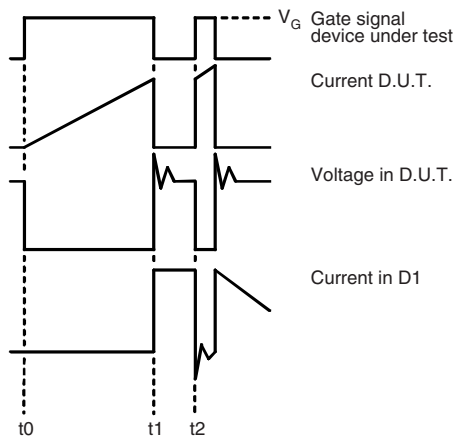
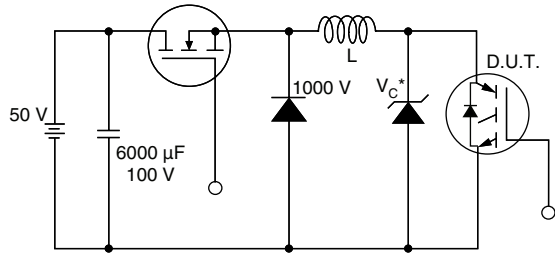

Fig. 17e - Macro Waveforms for Figure 18a's Test Circuit



* Driver same type as D.U.T.; $V_C = 80\%$ of V_{CE} (max)

Note: Due to the 50 V power supply, pulse width and inductor will increase to obtain rated I_d

Fig. 18 - Clamped Inductive Load Test Circuit

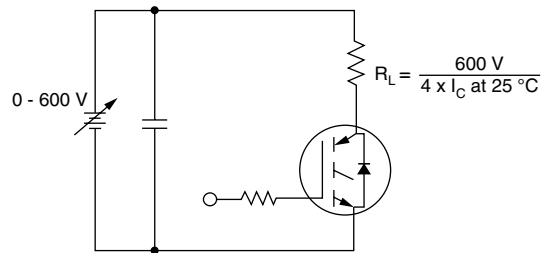

Fig. 19 - Pulsed Collector Current Test Circuit

ORDERING INFORMATION TABLE

Device code	G	A	75	T	S	120	U	PbF
	①	②	③	④	⑤	⑥	⑦	⑧

- 1** - Insulated gate bipolar transistor (IGBT)
- 2** - Generation 4, IGBT silicon, DBC construction
- 3** - Current rating (75 = 75 A)
- 4** - Circuit configuration (T = Half-bridge)
- 5** - Package indicator (INT-A-PAK)
- 6** - Voltage rating (120 = 1200 V)
- 7** - Speed/type (U = Ultrafast)
- 8** - PbF = Lead (Pb)-free

CIRCUIT CONFIGURATION

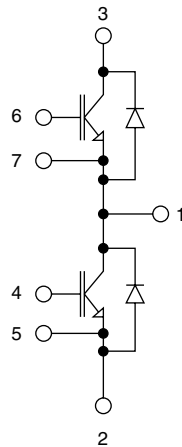

LINKS TO RELATED DOCUMENTS

Dimensions

www.vishay.com/doc?95173

INT-A-PAK IGBT

DIMENSIONS in millimeters (inches)

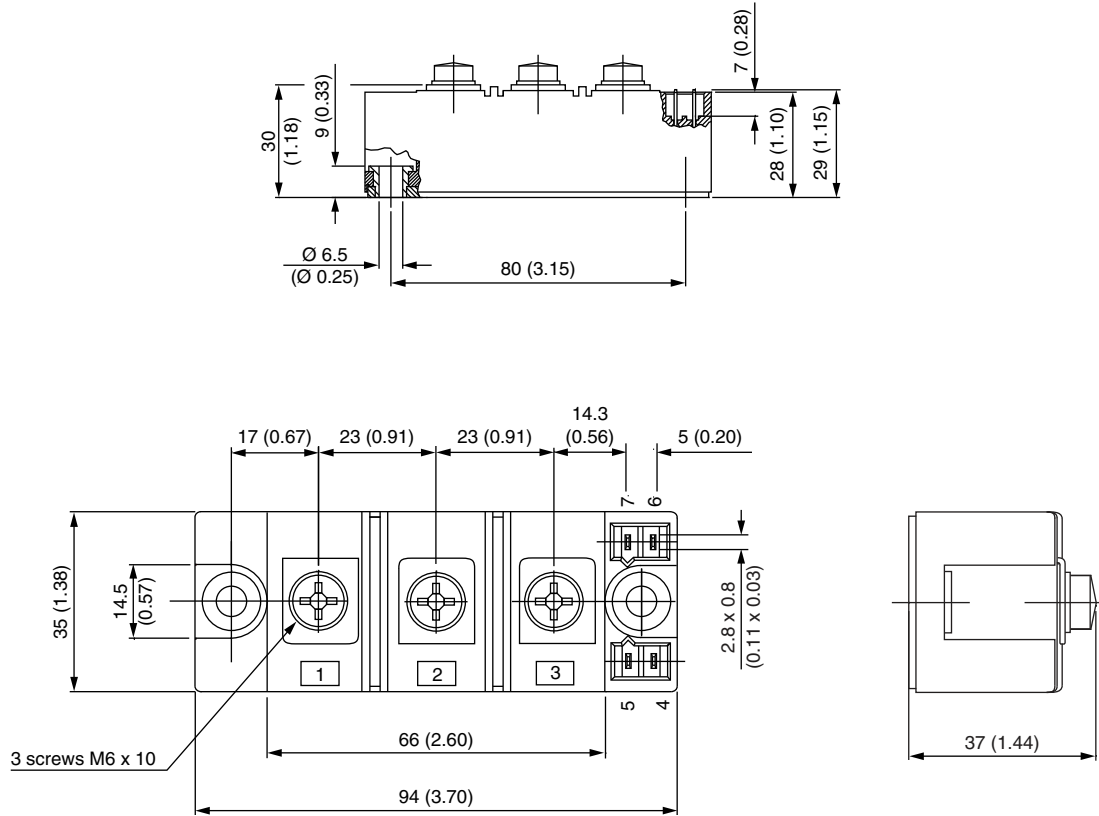



Disclaimer

ALL PRODUCT, PRODUCT SPECIFICATIONS AND DATA ARE SUBJECT TO CHANGE WITHOUT NOTICE TO IMPROVE RELIABILITY, FUNCTION OR DESIGN OR OTHERWISE.

Vishay Intertechnology, Inc., its affiliates, agents, and employees, and all persons acting on its or their behalf (collectively, "Vishay"), disclaim any and all liability for any errors, inaccuracies or incompleteness contained in any datasheet or in any other disclosure relating to any product.

Vishay makes no warranty, representation or guarantee regarding the suitability of the products for any particular purpose or the continuing production of any product. To the maximum extent permitted by applicable law, Vishay disclaims (i) any and all liability arising out of the application or use of any product, (ii) any and all liability, including without limitation special, consequential or incidental damages, and (iii) any and all implied warranties, including warranties of fitness for particular purpose, non-infringement and merchantability.

Statements regarding the suitability of products for certain types of applications are based on Vishay's knowledge of typical requirements that are often placed on Vishay products in generic applications. Such statements are not binding statements about the suitability of products for a particular application. It is the customer's responsibility to validate that a particular product with the properties described in the product specification is suitable for use in a particular application. Parameters provided in datasheets and/or specifications may vary in different applications and performance may vary over time. All operating parameters, including typical parameters, must be validated for each customer application by the customer's technical experts. Product specifications do not expand or otherwise modify Vishay's terms and conditions of purchase, including but not limited to the warranty expressed therein.

Except as expressly indicated in writing, Vishay products are not designed for use in medical, life-saving, or life-sustaining applications or for any other application in which the failure of the Vishay product could result in personal injury or death. Customers using or selling Vishay products not expressly indicated for use in such applications do so at their own risk and agree to fully indemnify and hold Vishay and its distributors harmless from and against any and all claims, liabilities, expenses and damages arising or resulting in connection with such use or sale, including attorneys fees, even if such claim alleges that Vishay or its distributor was negligent regarding the design or manufacture of the part. Please contact authorized Vishay personnel to obtain written terms and conditions regarding products designed for such applications.

No license, express or implied, by estoppel or otherwise, to any intellectual property rights is granted by this document or by any conduct of Vishay. Product names and markings noted herein may be trademarks of their respective owners.

Material Category Policy

Vishay Intertechnology, Inc. hereby certifies that all its products that are identified as RoHS-Compliant fulfill the definitions and restrictions defined under Directive 2011/65/EU of The European Parliament and of the Council of June 8, 2011 on the restriction of the use of certain hazardous substances in electrical and electronic equipment (EEE) - recast, unless otherwise specified as non-compliant.

Please note that some Vishay documentation may still make reference to RoHS Directive 2002/95/EC. We confirm that all the products identified as being compliant to Directive 2002/95/EC conform to Directive 2011/65/EU.



Стандарт Электрон Связь

Мы молодая и активно развивающаяся компания в области поставок электронных компонентов. Мы поставляем электронные компоненты отечественного и импортного производства напрямую от производителей и с крупнейших складов мира.

Благодаря сотрудничеству с мировыми поставщиками мы осуществляем комплексные и плановые поставки широчайшего спектра электронных компонентов.

Собственная эффективная логистика и склад в обеспечивает надежную поставку продукции в точно указанные сроки по всей России.

Мы осуществляем техническую поддержку нашим клиентам и предпродажную проверку качества продукции. На все поставляемые продукты мы предоставляем гарантию .

Осуществляем поставки продукции под контролем ВП МО РФ на предприятия военно-промышленного комплекса России , а также работаем в рамках 275 ФЗ с открытием отдельных счетов в уполномоченном банке. Система менеджмента качества компании соответствует требованиям ГОСТ ISO 9001.

Минимальные сроки поставки, гибкие цены, неограниченный ассортимент и индивидуальный подход к клиентам являются основой для выстраивания долгосрочного и эффективного сотрудничества с предприятиями радиоэлектронной промышленности, предприятиями ВПК и научно-исследовательскими институтами России.

С нами вы становитесь еще успешнее!

Наши контакты:

Телефон: +7 812 627 14 35

Электронная почта: sales@st-electron.ru

Адрес: 198099, Санкт-Петербург,
Промышленная ул, дом № 19, литера Н,
помещение 100-Н Офис 331