

# Analog Devices Welcomes Hittite Microwave Corporation

NO CONTENT ON THE ATTACHED DOCUMENT HAS CHANGED



**THIS PAGE INTENTIONALLY LEFT BLANK**

## SMT GaAs MMIC x2 ACTIVE FREQUENCY MULTIPLIER, 13 - 24.6 GHz OUTPUT

### Typical Applications

The HMC814LC3B is ideal for:

- Clock Generation Applications:  
SONET OC-192 & SDH STM-64
- Point-to-Point & VSAT Radios
- Test Instrumentation
- Military & Space
- Sensors

### Features

- High Output Power: +17 dBm
- Low Input Power Drive: 0 to +6 dBm
- Fo Isolation: >20 dBc @ Fout = 19 GHz
- 100 kHz SSB Phase Noise: -136 dBc/Hz
- Single Supply: +5V @ 88 mA
- 12 Lead 3x3 mm SMT Package: 9 mm<sup>2</sup>

### Functional Diagram

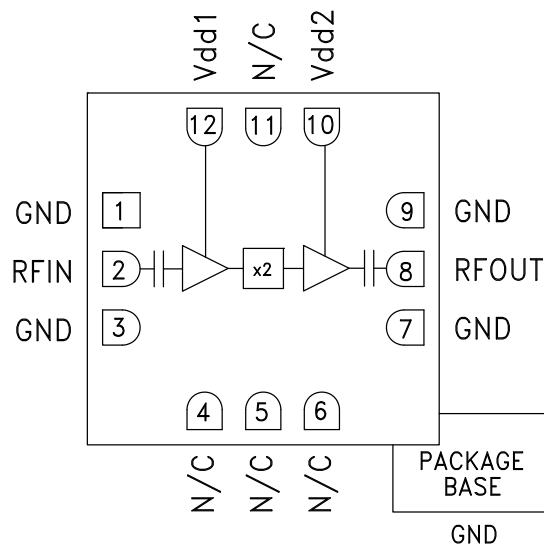

### General Description

The HMC814LC3B is a x2 active broadband frequency multiplier utilizing GaAs pHEMT technology in a leadless RoHS compliant SMT package. When driven by a +4 dBm signal, the multiplier provides +17 dBm typical output power from 13 to 24.6 GHz. The Fo, 3Fo and 4Fo isolations are >20 dBc at 19 GHz. The HMC814LC3B is ideal for use in LO multiplier chains for Pt-to-Pt & VSAT Radios yielding reduced parts count vs. traditional approaches. The low additive SSB Phase Noise of -136 dBc/Hz at 100 kHz offset helps maintain good system noise performance. The RoHS packaged HMC814LC3B eliminates the need for wire bonding, and allows the use of surface mount manufacturing techniques.

### Electrical Specifications, $T_A = +25^\circ \text{C}$ , $V_{dd1}, V_{dd2} = +5\text{V}$ , +4 dBm Drive Level

| Parameter   | Min.       | Typ. | Max. | Units  |
|---|------------|------|------|--------|
| Frequency Range, Input                                      | 6.5 - 12.3 |      |      | GHz    |
| Frequency Range, Output                                     | 13 - 24.6  |      |      | GHz    |
| Output Power  | 14         | 17   |      | dBm    |
| Fo Isolation (with respect to output level)                 |            | 25   |      | dBc    |
| 3Fo Isolation (with respect to output level)                |            | 25   |      | dBc    |
| Input Return Loss   | 4          | 10   |      | dB     |
| Output Return Loss  | 6          | 12   |      | dB     |
| SSB Phase Noise (100 kHz Offset @ Input Frequency = 19 GHz) |            | -136 |      | dBc/Hz |
| Supply Current (I <sub>dd1</sub> & I <sub>dd2</sub> )       | 70         | 88   | 100  | mA     |



## SMT GaAs MMIC x2 ACTIVE FREQUENCY MULTIPLIER, 13 - 24.6 GHz OUTPUT

**Output Power vs. Temperature @ +4 dBm Drive Level**

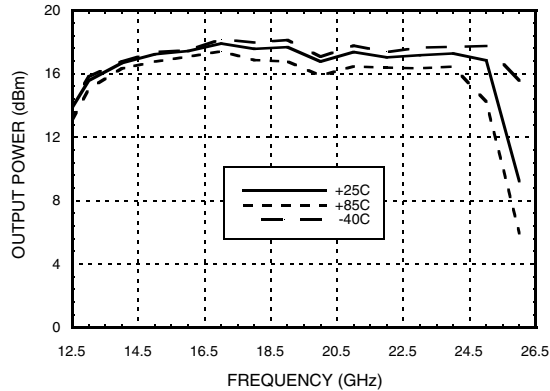

**Output Power vs. Drive Level**

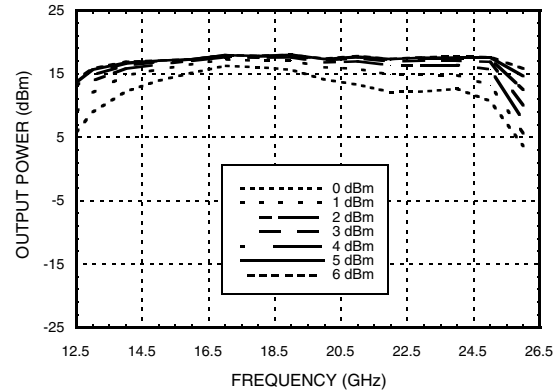

**Output Power vs. Supply Voltage @ +4 dBm Drive Level**

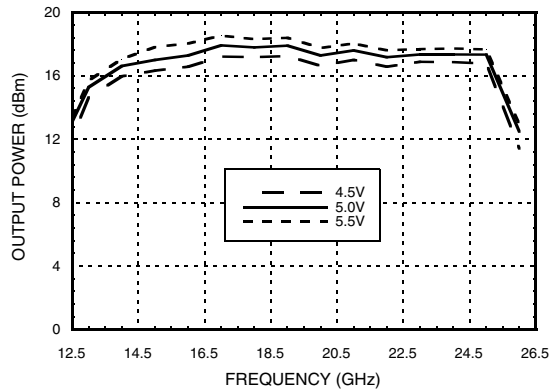

**Isolation @ +4 dBm Drive Level**

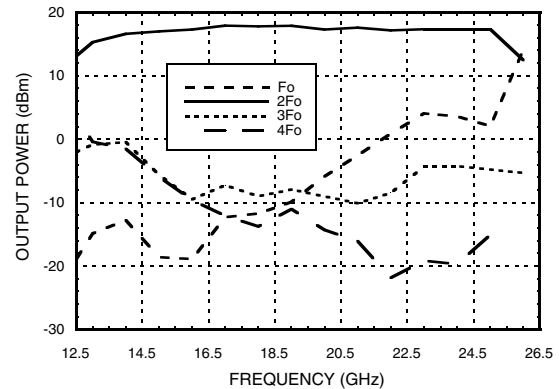

**Output Power vs. Input Power**

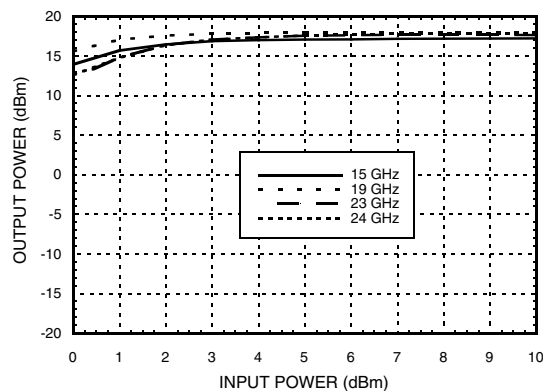

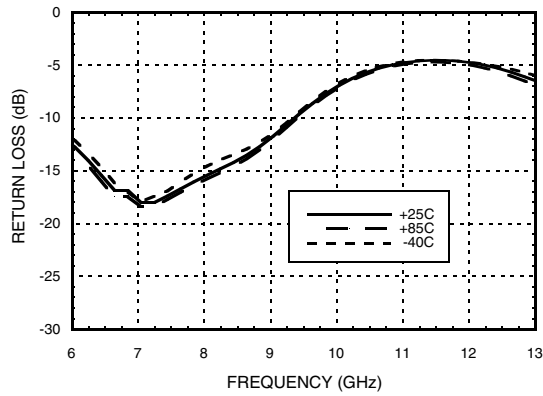
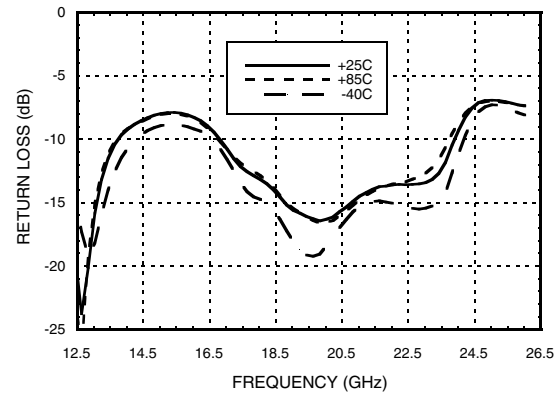
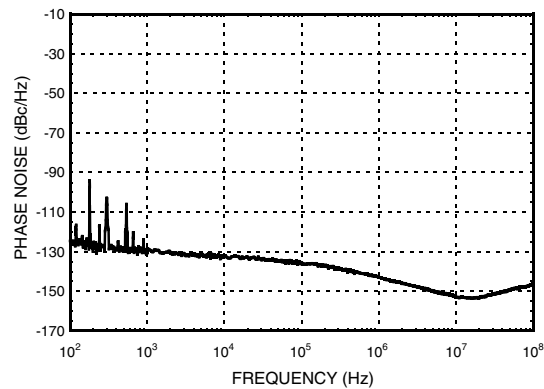
**SMT GaAs MMIC x2 ACTIVE FREQUENCY MULTIPLIER, 13 - 24.6 GHz OUTPUT**
**Input Return Loss vs. Temperature**

**Output Return Loss vs. Temperature**

**Phase Noise @ 19 GHz**

## SMT GaAs MMIC x2 ACTIVE FREQUENCY MULTIPLIER, 13 - 24.6 GHz OUTPUT

### Absolute Maximum Ratings

|   |                        |
|---|------------------------|
| RF Input (Vdd = +5V)  | +10 dBm                |
| Supply Voltage (Vdd1, Vdd2)                                   | +5.5 Vdc               |
| Channel Temperature   | 175 °C                 |
| Continuous Pdiss (T= 85 °C)<br>(derate 8.3 mW/°C above 85 °C) | 743 mW                 |
| Thermal Resistance<br>(channel to ground paddle)              | 121 °C/W               |
| Storage Temperature   | -65 to +150 °C         |
| Operating Temperature   | -40 to +85 °C          |
| ESD Sensitivity (HBM)   | Class 0 (Passed 150 V) |

### Typical Supply Current vs. Vdd

| Vdd (Vdc) | Idd (mA) |
|-----------|----------|
| 4.5       | 87       |
| 5.0       | 88       |
| 5.5       | 89       |

Note:  
Multiplier will operate over full voltage range shown above.



ELECTROSTATIC SENSITIVE DEVICE  
OBSERVE HANDLING PRECAUTIONS

### Outline Drawing

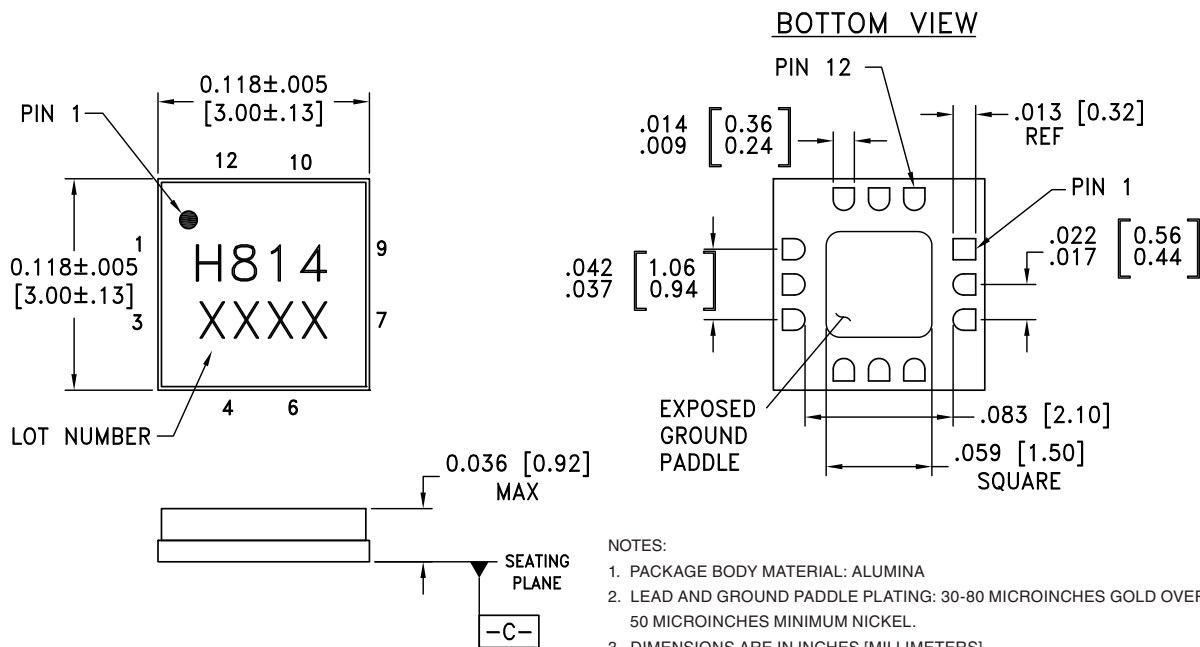

- NOTES:
1. PACKAGE BODY MATERIAL: ALUMINA
  2. LEAD AND GROUND PADDLE PLATING: 30-80 MICROINCHES GOLD OVER 50 MICROINCHES MINIMUM NICKEL.
  3. DIMENSIONS ARE IN INCHES [MILLIMETERS].
  4. LEAD SPACING TOLERANCE IS NON-CUMULATIVE
  5. PACKAGE WARP SHALL NOT EXCEED 0.05mm DATUM [-C-]
  6. ALL GROUND LEADS AND GROUND PADDLE MUST BE SOLDERED TO PCB RF GROUND.

### Package Information

| Part Number | Package Body Material | Lead Finish      | MSL Rating          | Package Marking <sup>[2]</sup> |
|-------------|-----------------------|------------------|---------------------|--------------------------------|
| HMC814LC3B  | Alumina, White        | Gold over Nickel | MSL3 <sup>[1]</sup> | H814<br>XXXX                   |

[1] Max peak reflow temperature of 260 °C

[2] 4-Digit lot number XXXX

**SMT GaAs MMIC x2 ACTIVE FREQUENCY MULTIPLIER, 13 - 24.6 GHz OUTPUT**
**Pin Description**

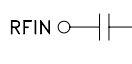
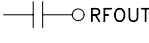
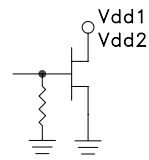
| Pin Number | Function   | Description  | Interface Schematic   |
|------------|------------|--|---|
| 1, 3, 7, 9 | GND        | Package bottom must also be connected to RF/DC ground.   |  |
| 2          | RFIN       | This pin is AC coupled and matched to 50 Ohms.   |  |
| 4 - 6, 11  | N/C        | These pins are not connected internally; however, all data shown herein was measured with these pins connected to RF/ DC ground. |   |
| 8          | RFOUT      | This pin is AC coupled and matched to 50 Ohms.   |  |
| 10, 12     | Vdd2, Vdd1 | Supply voltage 5V ± 0.5V. External bypass capacitors of 100 pF, 1,000 pF and 2.2 μF are recommended.                             |  |

**Application Circuit**

| Component | Value    |
|-----------|----------|
| C1, C2    | 100 pF   |
| C3, C4    | 1,000 pF |
| C5, C6    | 2.2 μF   |

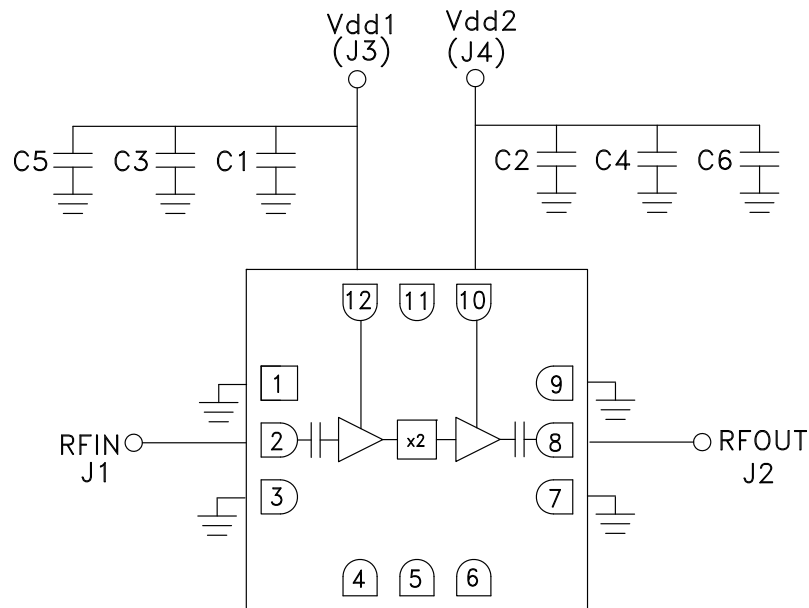



## SMT GaAs MMIC x2 ACTIVE FREQUENCY MULTIPLIER, 13 - 24.6 GHz OUTPUT

### Evaluation PCB

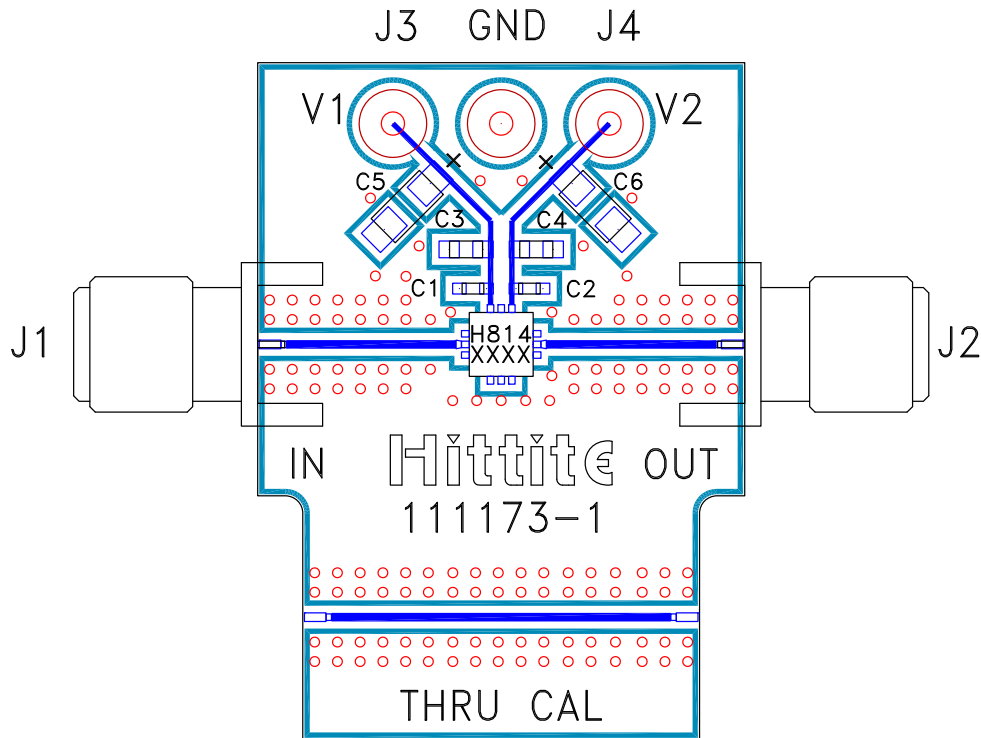

### List of Materials for Evaluation PCB 112409 [1]

| Item    | Description                     |
|---------|---------------------------------|
| J1, J2  | PCB Mount SRI K Connector       |
| J3 - J5 | DC Pin                          |
| C1, C2  | 100 pF Capacitor, 0402 Pkg.     |
| C3, C4  | 1,000 pF Capacitor, 0603 Pkg.   |
| C5, C6  | 2.2 μF Tantalum Capacitor       |
| U1      | HMC814LC3B x2 Active Multiplier |
| PCB [2] | 111173 Eval Board               |

[1] Reference this number when ordering complete evaluation PCB

[2] Circuit Board Material: Rogers 4350 or Arlon 25FR

The circuit board used in the application should be generated with proper RF circuit design techniques. Signal lines should have 50 Ohm impedance while the package ground leads and exposed paddle should be connected directly to the ground plane similar to that shown. A sufficient number of via holes should be used to connect the top and bottom ground planes. The evaluation circuit board shown is available from Hittite upon request.





**Стандарт  
Электрон  
Связь**

Мы молодая и активно развивающаяся компания в области поставок электронных компонентов. Мы поставляем электронные компоненты отечественного и импортного производства напрямую от производителей и с крупнейших складов мира.

Благодаря сотрудничеству с мировыми поставщиками мы осуществляем комплексные и плановые поставки широчайшего спектра электронных компонентов.

Собственная эффективная логистика и склад в обеспечивает надежную поставку продукции в точно указанные сроки по всей России.

Мы осуществляем техническую поддержку нашим клиентам и предпродажную проверку качества продукции. На все поставляемые продукты мы предоставляем гарантию .

Осуществляем поставки продукции под контролем ВП МО РФ на предприятия военно-промышленного комплекса России , а также работаем в рамках 275 ФЗ с открытием отдельных счетов в уполномоченном банке. Система менеджмента качества компании соответствует требованиям ГОСТ ISO 9001.

Минимальные сроки поставки, гибкие цены, неограниченный ассортимент и индивидуальный подход к клиентам являются основой для выстраивания долгосрочного и эффективного сотрудничества с предприятиями радиоэлектронной промышленности, предприятиями ВПК и научно-исследовательскими институтами России.

С нами вы становитесь еще успешнее!

**Наши контакты:**

**Телефон:** +7 812 627 14 35

**Электронная почта:** [sales@st-electron.ru](mailto:sales@st-electron.ru)

**Адрес:** 198099, Санкт-Петербург,  
Промышленная ул, дом № 19, литера Н,  
помещение 100-Н Офис 331