

Cree® Screen Master® 4-mm Oval LED S4SMS-RJF/GJF/BJF



PRODUCT DESCRIPTION

These oval LEDs are designed for full color video displays and signs for live action events and advertising signs. The oval-shaped radiation pattern and high luminous intensity ensure that these devices are excellent for wide-field-of-view outdoor applications where a wide viewing angle and readability in sunlight are essential.

These lamps are made with an advanced optical-grade epoxy that offers superior high-temperature and high-moisture-resistance performance in outdoor signal and sign applications. The encapsulation resin contains anti-UV material in order to reduce the effects of long-term exposure to direct sunlight.

FEATURES

- Size (mm): 4
- Color and Typical Dominant Wavelength:
Red (621nm)
Green(527nm)
Blue(472nm)
- Luminous Intensity (mcd)
S4SMS-RJF: (770-2130)
S4SMS-GJF: (2130-5860)
S4SMS-BJF: (390-1100)
- Lead - Free
- RoHS Compliant

APPLICATIONS

- Electronic Signs & Signals (ESS)
- Full Color video screen
- Motorway Signs
- Variable Message Sign (VMS)
- Advertising signs
- Petrol Signs

ABSOLUTE MAXIMUM RATINGS ($T_A = 25^\circ\text{C}$)

Items	Symbol	Absolute Maximum Rating		Unit
		Red	Blue and Green	
Forward Current	I_F	50 ^{Note1}	35	mA
Peak Forward Current ^{Note2}	I_{FP}	200	100	mA
Reverse Voltage	V_R	5	5	V
Power Dissipation	P_D	130	140	mW
Operation Temperature	T_{opr}	-40 ~ +95		$^\circ\text{C}$
Storage Temperature	T_{stg}	-40 ~ +100		$^\circ\text{C}$
Lead Soldering Temperature	T_{sol}	Max. 260 $^\circ\text{C}$ for 3 sec. max. (3 mm from the base of the epoxy bulb)		
Electrostatic Discharge Classification (MIL-STD-883E)	ESD	Class 2		

Note:

1. For long term performance the drive currents between 10mA and 30mA are recommended. Please contact CREE sales representative for more information on recommended drive conditions.
2. Pulse width ≤ 0.1 msec, duty $\leq 1/10$.

TYPICAL ELECTRICAL & OPTICAL CHARACTERISTICS ($T_A = 25^\circ\text{C}$)

Characteristics	Color	Symbol	Condition	Unit	Minimum	Typical	Maximum
Forward Voltage	Red	V_F	$I_F = 15$ mA	V		2.1	2.6
	Green	V_F	$I_F = 15$ mA	V		2.7	3.4
	Blue	V_F	$I_F = 10$ mA	V		2.8	3.4
Reverse Current	Red	I_R	$V_R = 5$ V	μA			100
	Blue/Green	I_R	$V_R = 5$ V	μA			100
Dominant Wavelength	Red	λ_D	$I_F = 15$ mA	nm	619	621	624
	Green	λ_D	$I_F = 15$ mA	nm	520	527	535
	Blue	λ_D	$I_F = 10$ mA	nm	460	472	475
Peak Luminous Intensity at -10 $^\circ$ ^{Note3}	Red	I_V	$I_F = 15$ mA	mcd	770	1200	
	Green	I_V	$I_F = 15$ mA	mcd	2130	3800	
	Blue	I_V	$I_F = 10$ mA	mcd	390	660	
Peak Luminous Intensity at -10 $^\circ$ ^{Note3(Reference)}	Red	I_V	$I_F = 20$ mA(R/G/B)	mcd		1500	
	Green	I_V		mcd		4600	
	Blue	I_V		mcd		1300	

Note:

3. Luminous intensity sorting based on the peak data at -10 $^\circ$.

INTENSITY BIN LIMIT (RED $I_f = 15$ mA, GREEN $I_f = 15$ mA, BLUE $I_f = 10$ mA) INTENSITY MEASUREMENT AT -10°)

Red: S4SMS-RJF

Bin Code	Sub-bin	Min. (mcd)	Max. (mcd)
S0	S1	770	852
	S2	852	934
	S3	934	1017
	S4	1017	1100
T0	T1	1100	1205
	T2	1205	1310
	T3	1310	1415
	T4	1415	1520
U0	U1	1520	1672
	U2	1672	1824
	U3	1824	1976
	U4	1976	2130

Green: S4SMS-GJF

Bin Code	Sub-bin	Min. (mcd)	Max. (mcd)
V0	V1	2130	2347
	V2	2347	2564
	V3	2564	2781
	V4	2781	3000
W0	W1	3000	3295
	W2	3295	3590
	W3	3590	3885
	W4	3885	4180
X0	X1	4180	4600
	X2	4600	5020
	X3	5020	5440
	X4	5440	5860

Blue: S4SMS-BJF

Bin Code	Sub-bin	Min. (mcd)	Max. (mcd)
Q0	Q1	390	430
	Q2	430	470
	Q3	470	510
	Q4	510	550
R0	R1	550	605
	R2	605	660
	R3	660	715
	R4	715	770
S0	S1	770	852
	S2	852	934
	S3	934	1017
	S4	1017	1100

- Tolerance of measurement of luminous intensity is $\pm 15\%$

COLOR BIN LIMIT (RED $I_f = 15$ mA, GREEN $I_f = 15$ mA, BLUE $I_f = 10$ mA)

Red

Bin Code	Min.(nm)	Max.(nm)
RB	619	624

Green

Bin Code	Min.(nm)	Max.(nm)
GM	520	523
GN	520.5	523.5
GP	522	525
GQ	523	526
GR	524.5	527.5
GS	525.5	528.5
GT	527	530
GU	528	531
GV	529.5	532.5
GW	530.5	533.5
GX	532	535

Blue

Bin Code	Min.(nm)	Max.(nm)
BG	460	463
BH	461.5	464.5
BJ	462.5	465.5
BK	464	467
BM	465	468
BN	466.5	469.5
BP	467.5	470.5
BQ	469	472
BR	470	473
BS	471.5	474.5
BT	472	475

- Tolerance of measurement of dominant wavelength is ± 1 nm

ORDER CODE TABLE*
S4SMS-RJF

Color	Kit Number	Luminous Intensity (mcd)		Dominant Wavelength				Package
		Min.	Max.	Color Bin	Min. (nm)	Color Bin	Max. (nm)	
Red	S4SMS-RJF-CS0U0BB1	770	2130	RB	619	RB	624	Bulk
Red	S4SMS-RJF-CS12QBB1	Any 2 consecutive sub-bins: S1 (770) - T2 (1310)		RB	619	RB	624	Bulk
Red	S4SMS-RJF-CS32QBB1	Any 2 consecutive sub-bins: S3 (934) - T4 (1520)		RB	619	RB	624	Bulk
Red	S4SMS-RJF-CS0U0BB2	770	2130	RB	619	RB	624	Ammo
Red	S4SMS-RJF-CS12QBB2	Any 2 consecutive sub-bins: S1 (770) - T2 (1310)		RB	619	RB	624	Ammo
Red	S4SMS-RJF-CS32QBB2	Any 2 consecutive sub-bins: S3 (934) - T4 (1520)		RB	619	RB	624	Ammo

S4SMS-GJF

Color	Kit Number	Luminous Intensity (mcd)		Dominant Wavelength				Package
		Min.	Max.	Color Bin	Min. (nm)	Color Bin	Max. (nm)	
Green	S4SMS-GJF-CV0X0MX1	2130	5860	GM	520	GX	535	Bulk
Green	S4SMS-GJF-CV42QMF1	Any 2 consecutive sub-bins: V4 (2781) - X1 (4600)		Any consecutive 3nm within GM(520) to GX(535)				Bulk
Green	S4SMS-GJF-CW12QMF1	Any 2 consecutive sub-bins: W1 (3000) - X2 (5020)		Any consecutive 3nm within GM(520) to GX(535)				Bulk
Green	S4SMS-GJF-CV0X0MX2	2130	5860	GM	520	GX	535	Ammo
Green	S4SMS-GJF-CV42QMF2	Any 2 consecutive sub-bins: V4 (2781) - X1 (4600)		Any consecutive 3nm within GM(520) to GX(535)				Ammo
Green	S4SMS-GJF-CW12QMF2	Any 2 consecutive sub-bins: W1 (3000) - X2 (5020)		Any consecutive 3nm within GM(520) to GX(535)				Ammo

S4SMS-BJF

Color	Kit Number	Luminous Intensity (mcd)		Dominant Wavelength				Package
		Min.	Max.	Color Bin	Min. (nm)	Color Bin	Max. (nm)	
Blue	S4SMS-BJF-CQ0S0GT1	390	1100	BG	460	BT	475	Bulk
Blue	S4SMS-BJF-CQ32QGF1	Any 2 consecutive sub-bins: Q3 (470) - R4 (770)		Any consecutive 3nm within BG(460) to BT(475)				Bulk
Blue	S4SMS-BJF-CQ42QGF1	Any 2 consecutive sub-bins: Q4 (510) - S1 (852)		Any consecutive 3nm within BG(460) to BT(475)				Bulk
Blue	S4SMS-BJF-CQ0S0GT2	390	1100	BG	460	BT	475	Ammo
Blue	S4SMS-BJF-CQ32QGF2	Any 2 consecutive sub-bins: Q3 (470) - R4 (770)		Any consecutive 3nm within BG(460) to BT(475)				Ammo
Blue	S4SMS-BJF-CQ42QGF2	Any 2 consecutive sub-bins: Q4 (510) - S1 (852)		Any consecutive 3nm within BG(460) to BT(475)				Ammo

Notes:

1. The above kit numbers represent order codes that include multiple intensity-bin and color-bin codes. Only one intensity-sub-bin code and one color-bin code will be shipped on each reel. Selected single intensity-bin, single color-bin codes will be orderable in certain quantities. For example, any 2 consecutive sub-bins from W1 to X2 mean either one combination out of W1-W2, W2-W3, W3-W4, W4-X1, X1-X2 will be shipped by Cree. For example, any one-color bin from GM to GX means only one color bin (GM or GN or GP or GQ or GR or GS or GT or GU or GV or GW or GX) will be shipped by Cree.
2. Please refer to the "Cree LED Lamp Reliability Test Standards" document for reliability test conditions.
3. Please refer to the "Cree LED Lamp Soldering & Handling" document for information about how to use this LED product safely.

GRAPHS

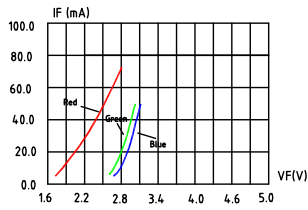

FIG.1 FORWARD CURRENT VS. FORWARD VOLTAGE.

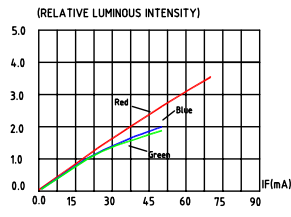

FIG.2 RELATIVE LUMINOUS INTENSITY VS. FORWARD CURRENT

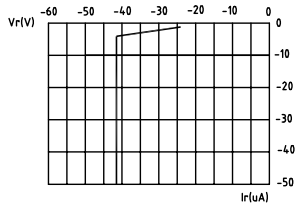

FIG.3a RED REVERSE CURRENT VS. REVERSE VOLTAGE.

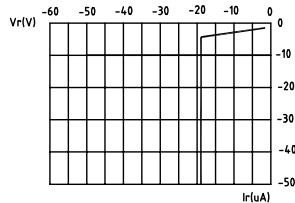

FIG.3b BLUE & GREEN REVERSE CURRENT VS. REVERSE VOLTAGE.

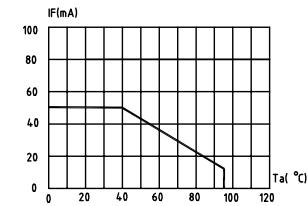

FIG.4a RED MAXIMUM FORWARD DC CURRENT VS AMBIENT TEMPERATURE ($T_{jmax}=105\text{ C}$) °

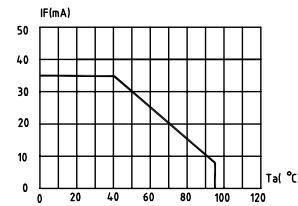

FIG.4b BLUE & GREEN MAXIMUM FORWARD DC CURRENT VS AMBIENT TEMPERATURE ($T_{jmax}=105\text{ C}$) °

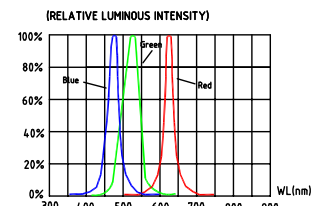

FIG.5 RELATIVE LUMINOUS INTENSITY VS. WAVELENGTH.

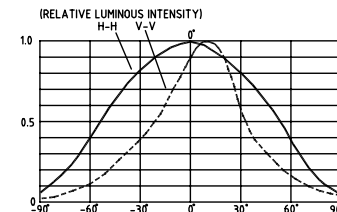

FIG.6a RED & BLUE&GREEN FAR FIELD PATTERN

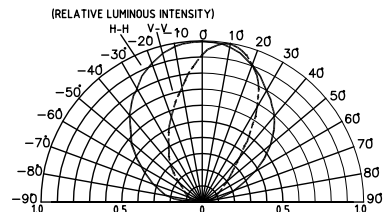

FIG.6b RED & BLUE&GREEN FAR FIELD PATTERN

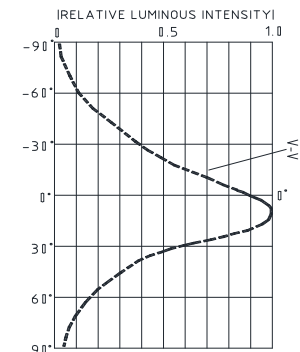

FIG.7 RED & BLUE&GREEN FAR FIELD PATTERN

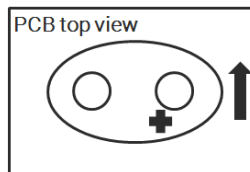

FIG.8 Recommended PCB structure for S4SMS application

The above data are collected from statistical figures that do not necessarily correspond to the actual parameters of each single LED. Hence, these data will be changed without further notice.

MECHANICAL DIMENSIONS

All dimensions are in mm. Tolerance is ± 0.25 mm unless otherwise noted.

An epoxy meniscus may extend about 1.5 mm down the leads.

Burr around bottom of epoxy may be 0.5 mm max.

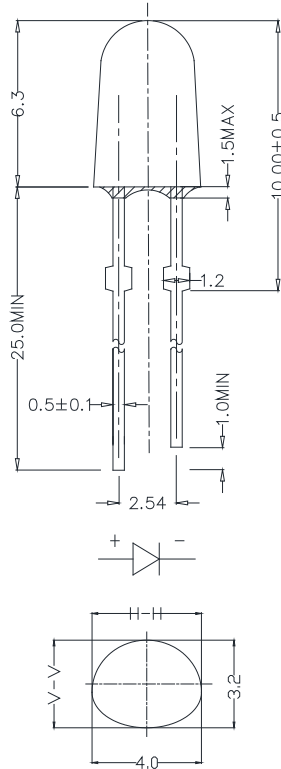

NOTES

Lead Frame Materials

Ag-plated and Lead-free Solder-plated iron.

RoHS Compliance

The levels of environmentally sensitive, persistent biologically toxic (PBT), persistent organic pollutants (POP), or otherwise restricted materials in this product are below the maximum concentration values (also referred to as the threshold limits) permitted for such substances, or are used in an exempted application, in accordance with EU Directive 2002/95/EC on the restriction of the use of certain hazardous substances in electrical and electronic equipment (RoHS), as amended through April 21, 2006.

Vision Advisory Claim

Users should be cautioned not to stare at the light of this LED product. The bright light can damage the eye.

KIT NUMBER SYSTEM

All dimensions in mm. Cree LED lamps are tested and sorted into performance bins. A bin is specified by ranges of color, forward voltage, and brightness. Sorted LEDs are packaged for shipping in various convenient options. Please refer to the "Cree LED Lamp Packaging Standard" document for more information about shipping and packaging options.

Cree LEDs are sold by order codes in combinations of bins called kits. Order codes are configured in the following manner:

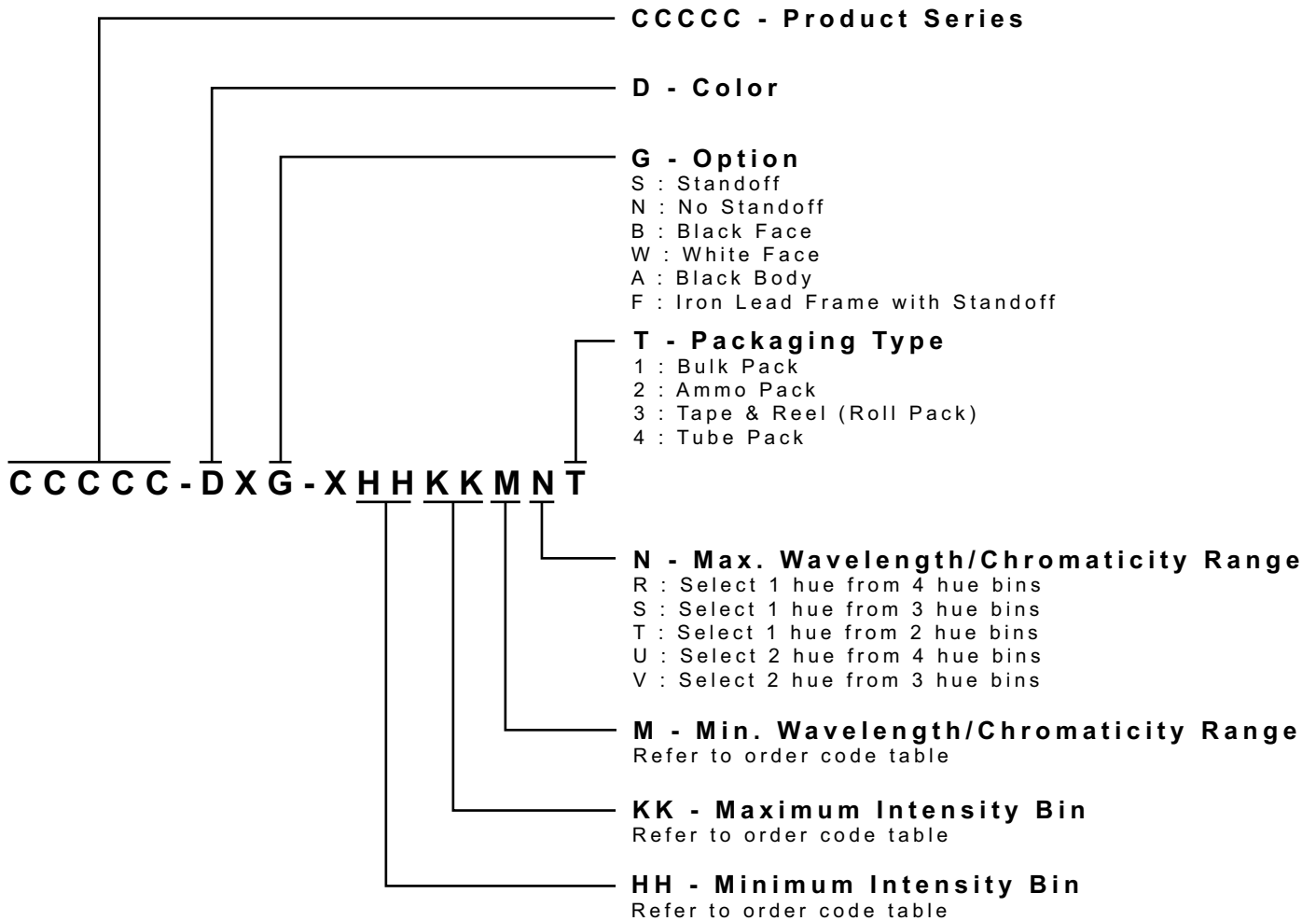

* Please contact our sales representative for ordering information.

PACKAGING

Features:

- The LEDs are packed in cardboard boxes after packaging in normal or anti-electrostatic bags.
- Cardboard boxes will be used to protect the LEDs from mechanical shock during transportation.
- The boxes are not water resistant, and they must be kept away from water and moisture.
- The Bulk Pack types of packaging.
- Max 1000 pcs per bulk and Max 3000 pcs per ammo.

Bulk Pack Packaging Type:

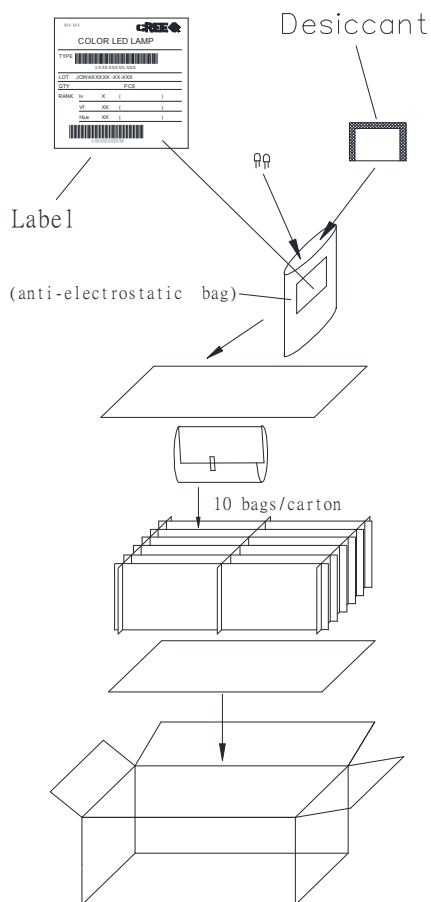

Ammo Pack Packaging Type:

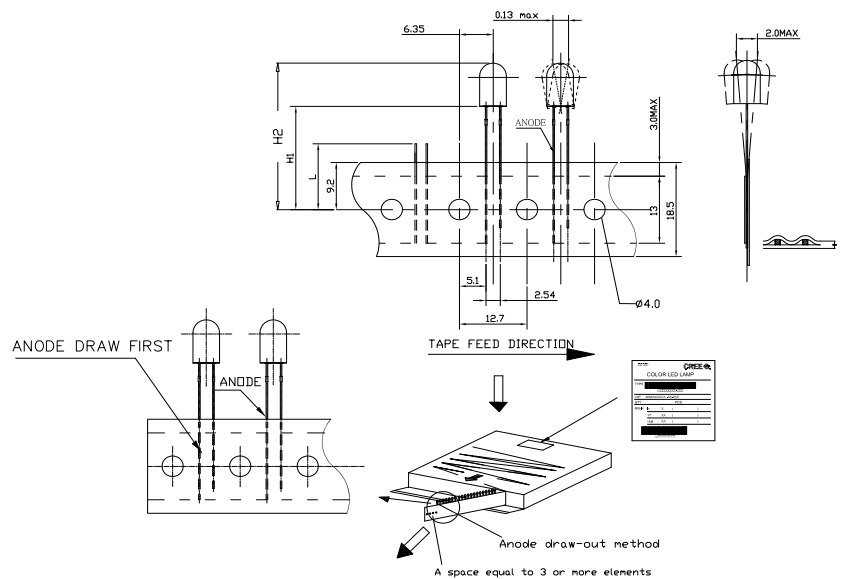



Стандарт Электрон Связь

Мы молодая и активно развивающаяся компания в области поставок электронных компонентов. Мы поставляем электронные компоненты отечественного и импортного производства напрямую от производителей и с крупнейших складов мира.

Благодаря сотрудничеству с мировыми поставщиками мы осуществляем комплексные и плановые поставки широчайшего спектра электронных компонентов.

Собственная эффективная логистика и склад в обеспечивает надежную поставку продукции в точно указанные сроки по всей России.

Мы осуществляем техническую поддержку нашим клиентам и предпродажную проверку качества продукции. На все поставляемые продукты мы предоставляем гарантию .

Осуществляем поставки продукции под контролем ВП МО РФ на предприятия военно-промышленного комплекса России , а также работаем в рамках 275 ФЗ с открытием отдельных счетов в уполномоченном банке. Система менеджмента качества компании соответствует требованиям ГОСТ ISO 9001.

Минимальные сроки поставки, гибкие цены, неограниченный ассортимент и индивидуальный подход к клиентам являются основой для выстраивания долгосрочного и эффективного сотрудничества с предприятиями радиоэлектронной промышленности, предприятиями ВПК и научно-исследовательскими институтами России.

С нами вы становитесь еще успешнее!

Наши контакты:

Телефон: +7 812 627 14 35

Электронная почта: sales@st-electron.ru

Адрес: 198099, Санкт-Петербург,
Промышленная ул, дом № 19, литера Н,
помещение 100-Н Офис 331